

SOUTH WING

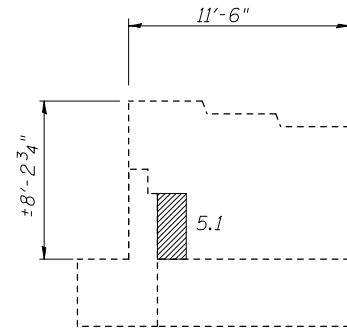

NORTH WING

WEST ABUTMENT

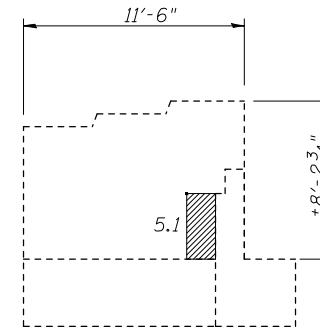

NORTH WING

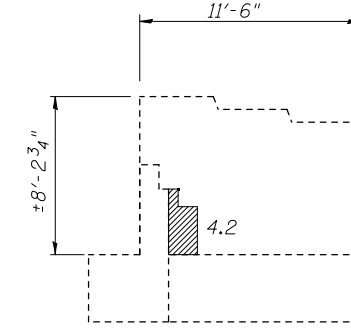

SOUTH WING

EAST ABUTMENT

S.N. 018-0049

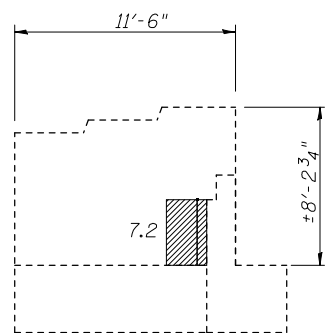

SOUTH WING

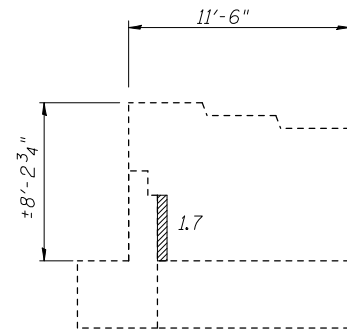

NORTH WING

WEST ABUTMENT

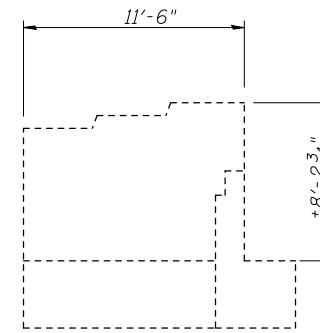

NORTH WING

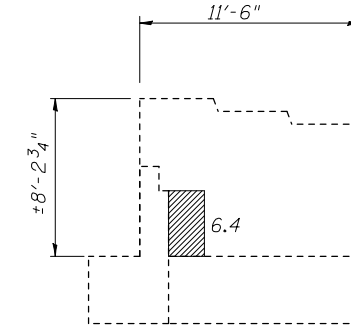

SOUTH WING

EAST ABUTMENT

S.N. 018-0050

LEGEND

 Structural Repair of Concrete
(Depth Equal To or Less Than 5")

**FOUR ABUTMENTS
BILL OF MATERIAL**

ITEM	UNIT	TOTAL
Structural Repair of Concrete (Depth Equal to or Less Than 5")	Sq. Ft.	31.4

BLANK, WESSELINK, COOK & ASSOCIATES DECATUR, ILLINOIS ENGINEERS - CONSULTANTS DESIGN FIRM NO. 184000894

FILE NAME =	USER NAME =	DESIGNED <i>PBB</i>	REVISED -
		CHECKED <i>MCB</i>	REVISED -
	PLOT SCALE =	DRAWN <i>MLO</i>	REVISED -
	PLOT DATE =	CHECKED <i>MCB</i>	REVISED -

**STATE OF ILLINOIS
DEPARTMENT OF TRANSPORTATION**

**CONCRETE REPAIR DETAILS (WINGWALLS)
STRUCTURE NO. 018-0049(W.B.) & 0050(E.B.)**

SHEET NO26 OF 42 SHEETS

F.A.I. RTE.	SECTION	COUNTY	TOTAL SHEETS	SHEET NO.
70	(18-47-VBK (18-47B, 18-47HB)BR	CUMBERLAND	147	118
ILLINOIS FED. AID PROJECT			CONTRACT NO. 74466	