

CENTER OF WEST COLLINS STREET

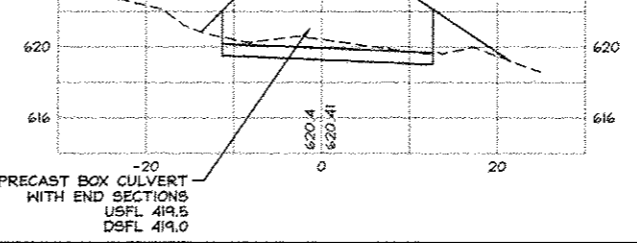

CENTER OF WEST MAIN STREET

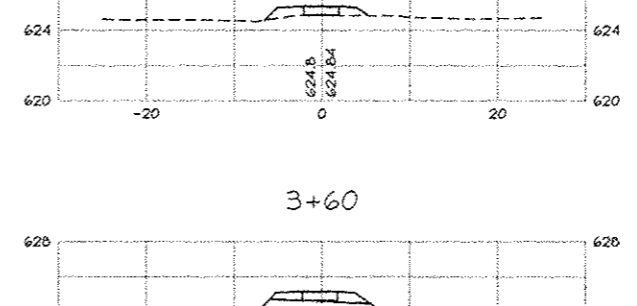
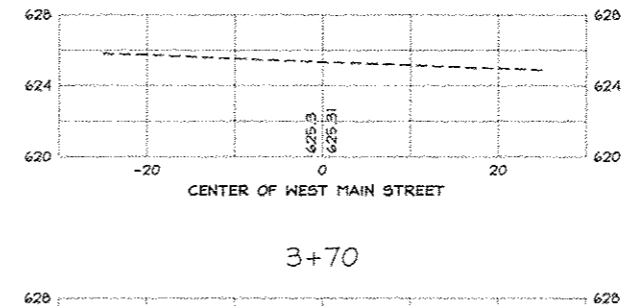
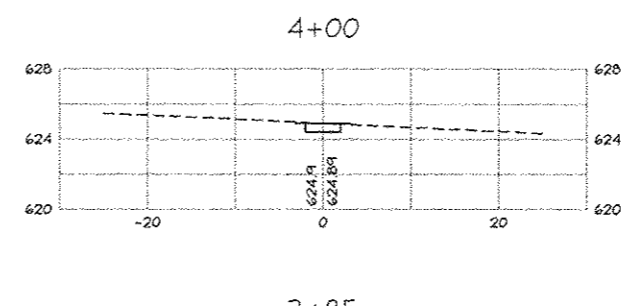
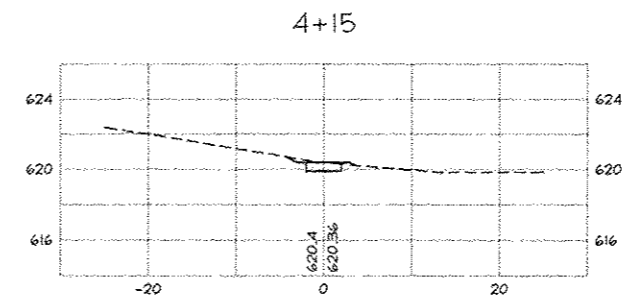
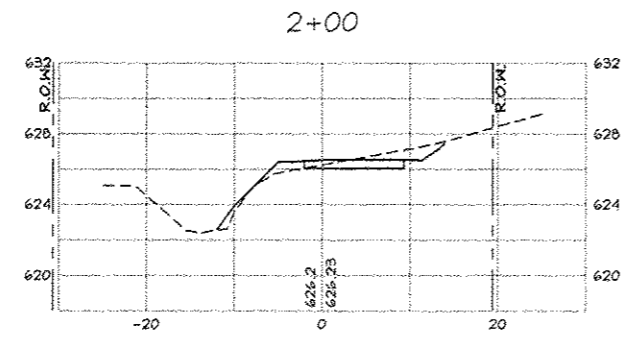
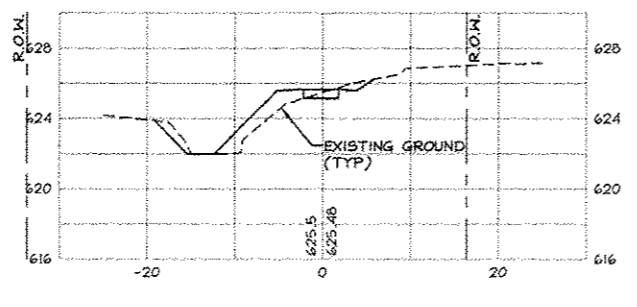
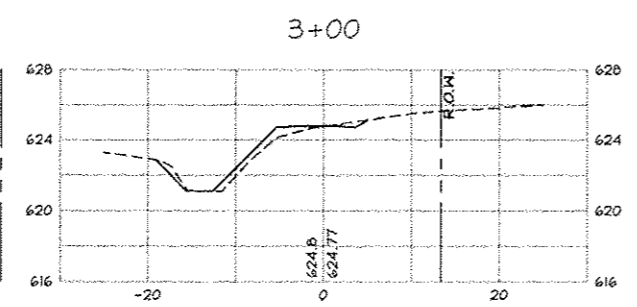
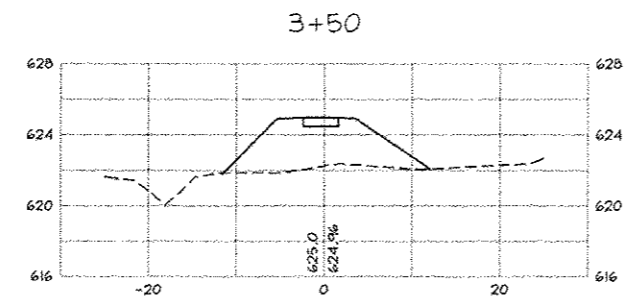
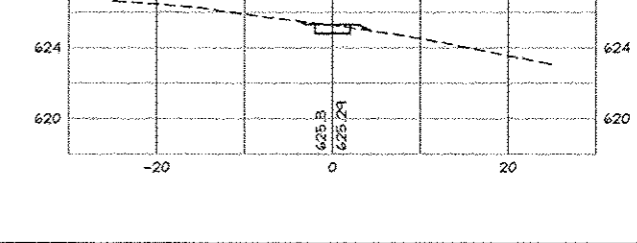
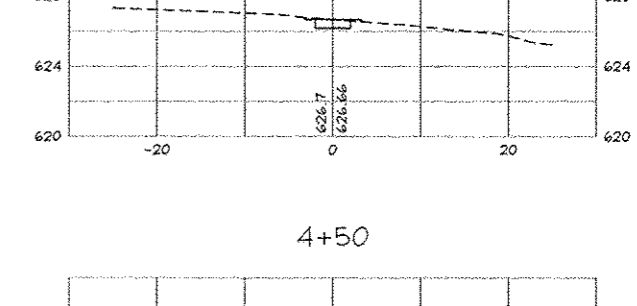
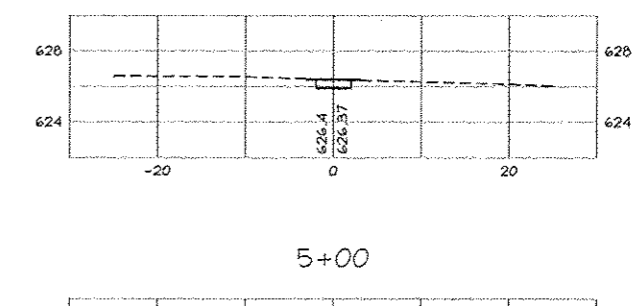
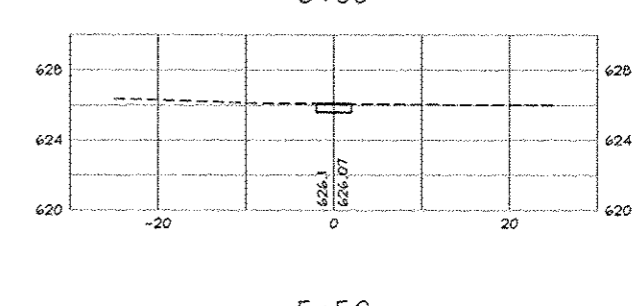
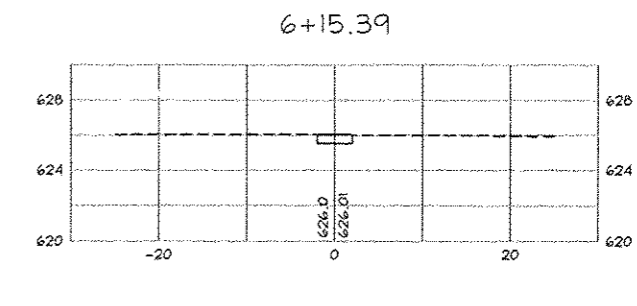

NO.	DESCRIPTION	BY	DATE	NO.	DESCRIPTION	BY	DATE
					DESIGNED		
					DRAWN	WFL	3/27/12
					CHECKED	JHC	3/27/12

VILLAGE OF GOREVILLE
 JOHNSON COUNTY, IL
 SCHOOL SAFE WAY PLAN
 SIDEWALK SECTIONS

JOHN H. CRAWFORD & ASSOCIATES, P.C.
 CIVIL ENGINEERS, LAND SURVEYORS
 201 SOUTH DIVISION STREET, CARTERSVILLE, ILLINOIS 62918
 PHONE (618) 985-4370 FAX (618) 985-4892
 PROFESSIONAL DESIGN FIRM # 184-002885

SHEET NO.	
15	
ISSUE	DATE
A	3/27/12

10/11/2012 10:34:53 AM