

---

**STRUCTURE GEOTECHNICAL REPORT  
CIRCLE INTERCHANGE RECONSTRUCTION  
RETAINING WALL 47 (PROPOSED SN 016-1834)  
F.A.I 94, (SB I-90/94 TAYLOR ST. BYPASS RAMP)  
STATION 6405+49.34 TO STATION 6407+76.39  
SECTION 2014-013 R&B-R  
IDOT D-91-227-13, PTB 163/ITEM 001  
COOK COUNTY, ILLINOIS**

---

**For  
AECOM  
303 East Wacker Drive  
Chicago, IL 60601  
(312) 938-0300**

**Submitted by  
Wang Engineering, Inc.  
1145 North Main Street  
Lombard, IL 60148  
(630) 953-9928**

**Original: August 23, 2017  
Revised: March 7, 2018**

**Technical Report Documentation Page**

|  |  |  |
|--|--|--|
| <b>1. Title and Subtitle</b><br>Structure Geotechnical Report<br>Circle Interchange Reconstruction<br>Retaining Wall 47, F.A.I. Route 94<br>Station 6405+49.34 to Station 6407+76.39   |  | <b>2. Report Date</b><br>Original: August 23, 2017<br>Revised: March 7, 2018   |
|  |  | <b>3. Report Type</b> <input checked="" type="checkbox"/> SGR <input type="checkbox"/> RGR<br><input type="checkbox"/> Draft <input checked="" type="checkbox"/> Final <input checked="" type="checkbox"/> Revised |
| <b>4. Route / Section / County</b><br>FAI 94/2014-013R&B -R/ Cook  |  | <b>5. IDOT Job No./Contract</b><br>D-91-259-12/60X93   |
| <b>6. PTB / Item No.</b><br>163/001  | <b>7. Existing Structure Number(s)</b><br>No existing wall   | <b>8. Proposed Structure Number(s)</b><br>016-1834   |
| <b>9. Prepared by</b><br>Wang Engineering, Inc.<br>1145 N Main Street<br>Lombard, IL 60148   | <b>Contributor(s)</b><br>Author: Metin W. Seyhun, P.E.<br>QC/QA: Mohammed Kothawala, P.E., D.GE.<br>PIC: Corina T. Farez, P.E., P.G. | <b>Author Phone Number/Email Address</b><br>(630) 953-9928 Ext 1018<br>mseyhun@wangeng.com   |
| <b>10. Prepared for</b><br>AECOM<br>303 East Wacker Drive<br>Chicago, IL 60601   | <b>Structural Engineer</b><br>Matt Santeford, P.E., S.E.<br>TranSystems  | <b>Contact Phone Number</b><br>(847) 407-5235  |
| <b>11. Abstract</b><br>A 402.51-foot long, 21.5 feet maximum retained height new retaining wall will be constructed to retain the proposed Taylor Street Bypass Ramp north approach. The proposed Mechanically Stabilized Earth (MSE) wall number 47 will wrap around the north approach roadway and abutment. This report provides geotechnical recommendations for the design and construction of the proposed retaining wall.<br><br>Beneath the pavement or topsoil, the subsurface soils consists of up to 11 feet of primarily cohesive fill, up to 10 feet medium stiff to very stiff clay crust, up to 44 feet of very soft to medium stiff silty clay, 25 feet of very stiff to hard clay loam, and 30 feet of hard silty clay loam or dense to very dense silt to silty loam extending to the boring termination depths or weathered bedrock. Sound bedrock was encountered at elevations of about 485 to 489 feet. Groundwater may be encountered within the fill layers at the upper 4 to 10 feet, during times of heavy precipitation.<br><br>Based on the encountered subsoil conditions and the wall height, the proposed MSE wall is feasible with preloading or ground improvement. In addition, the MSE wall will require Class III LCCF materials to have sufficient foundation bearing resistance in the back to back portion of the wall. The wall beyond the back to back portion should also have Class III LCCF as an embankment material as well as MSE wall material. We estimate the wall will have a maximum factored bearing resistance of 2,300 psf between Stations 6406+50 and 6407+70 and 1,600 psf between Stations 6405+49 and 6406+50 using a geotechnical resistance factor of 0.65. The wall will have sufficient resistance against sliding and overturning.<br><br>The maximum long-term consolidation settlement of foundation soils is estimated to be 1.5 inches near Station 6407+69.94. We estimate the soil will achieve 50% of primary consolidation settlement in 11 months and 90% of primary consolidation in 48 months. To reduce settlements to acceptable range of 1-inch for the roadway, we recommend either preloading for 6 months or a ground improvement by use of aggregate columns. The design and construction of aggregate columns should be as per IDOT Special Provision GBSP No. 71 <i>Aggregate Column Ground Improvement</i> . |  |  |
| <b>12. Path to archived file</b><br><small>S:\Netprojects\11000401\Reports\SGRs\Walls\1834 Wall 47\Revised Final stamped dated March 7, 2018\RPT_Wang_MWS_11000401SGRRevisedFinalWall47V03_20180307.doc</small>  |  |  |

## TABLE OF CONTENTS

|            |   |           |
|------------|---|-----------|
| <b>1.0</b> | <b>INTRODUCTION.....</b>  | <b>1</b>  |
| 1.1        | PROJECT DESCRIPTION.....  | 1         |
| 1.2        | PROPOSED STRUCTURE.....   | 2         |
| 1.3        | EXISTING STRUCTURE.....   | 2         |
| <b>2.0</b> | <b>SITE CONDITIONS AND GEOLOGICAL SETTING.....</b>                  | <b>2</b>  |
| 2.1        | PHYSIOGRAPHY.....   | 3         |
| 2.2        | SURFICIAL COVER.....  | 3         |
| 2.3        | BEDROCK.....  | 3         |
| <b>3.0</b> | <b>METHODS OF INVESTIGATION.....</b>                                | <b>4</b>  |
| 3.1        | SUBSURFACE INVESTIGATION.....                                       | 4         |
| 3.2        | VANE SHEAR TESTS.....   | 5         |
| 3.3        | LABORATORY TESTING.....   | 5         |
| <b>4.0</b> | <b>RESULTS OF FIELD AND LABORATORY INVESTIGATIONS.....</b>          | <b>6</b>  |
| 4.1        | SOIL CONDITIONS.....  | 6         |
| 4.2        | GROUNDWATER CONDITIONS.....   | 8         |
| 4.3        | SEISMIC DESIGN CONSIDERATIONS.....                                  | 9         |
| <b>5.0</b> | <b>ANALYSIS AND RECOMMENDATIONS.....</b>                            | <b>9</b>  |
| 5.1        | RETAINING WALL TYPE EVALUATION.....                                 | 9         |
| 5.2        | BEARING RESISTANCE AND EXTERNAL STABILITY ANALYSES.....             | 10        |
| 5.3        | SETTLEMENT ANALYSES.....  | 11        |
| 5.4        | GLOBAL STABILITY ANALYSES.....                                      | 13        |
| <b>6.0</b> | <b>CONSTRUCTION CONSIDERATIONS.....</b>                             | <b>13</b> |
| 6.1        | EXCAVATION.....   | 13        |
| 6.2        | DEWATERING.....   | 14        |
| 6.3        | FILLING AND BACKFILLING.....  | 14        |
| 6.4        | WALL CONSTRUCTION.....  | 14        |
| 6.5        | CONSTRUCTION MONITORING.....  | 14        |
| 6.6        | AGGREGATE COLUMN INSTALLATION AND EXISTING 84-INCH STORM SEWER..... | 14        |

**7.0 QUALIFICATIONS..... 15**

**REFERENCES ..... 16**

**EXHIBITS**

    1. *Site Location Map*

    2. *Site and Regional Geology*

    3. *Boring Location Plan*

    4. *Subsurface Soil Data Profile*

**APPENDIX A**

*Boring Logs and Rock Core Photographs*

**APPENDIX B**

*Laboratory Test Results*

**APPENDIX C**

*Type Size Location Plan*

**LIST OF TABLES**

Table 1: Summary of Consolidation Testing..... 7

Table 2: Estimated Long-Term Settlement ..... 12

Table 3: Estimated Equivalent Uniform Service Pressure for Aggregate Columns Design..... 13

---

**STRUCTURE GEOTECHNICAL REPORT**  
**CIRCLE INTERCHANGE RECONSTRUCTION**  
**RETAINING WALL 47 (PROPOSED SN 016-1834)**  
**F.A.I. ROUTE 94 (SB I-90/94 TAYLOR ST. BYPASS RAMP)**  
**STATION 6405+49.34 TO STATION 6407+76.39**  
**IDOT D-91-227-13/PTB 163-001**  
**COOK COUNTY, ILLINOIS**  
**FOR**  
**AECOM**

## **1.0 INTRODUCTION**

This report presents the results of Wang Engineering, Inc. (Wang) subsurface investigation, laboratory testing, and geotechnical engineering evaluations for the proposed wall SN 016-1834 (Retaining Wall 47) along F.A.I Route 94 (SB I-90/94 to Taylor Street Bypass Ramp) in the City of Chicago, Cook County, Illinois. A *Site Location Map* is presented as Exhibit 1.

The purpose of our investigation was to characterize the site soil and groundwater conditions, perform geotechnical engineering analyses, and provide recommendations for the design and construction of the new wall structure.

### **1.1 Project Description**

The Circle Interchange is over 50 years old and has significant congestion and safety problems. The project is aiming to improve safety and mobility as well as upgrade the mainline and interchange facilities. The project will also improve other modes of transportation such as transit, pedestrians and bicyclists within the same corridor.

The Circle Interchange Reconstruction project is along Interstate 90/94 (I-90/94) from south of Roosevelt Road to north of Lake Street, along Interstate 290 (I-290) from Loomis Street to the Circle Interchange; and along Congress Parkway from the Circle Interchange to Canal Street/Old Post Office. The routes typically have three lanes of traffic in each direction with mostly one lane ramp at interchanges. Locally, the north leg is known as the Kennedy Expressway, the south leg as the Dan Ryan Expressway and the west leg as the Eisenhower Expressway. Within the project area, there are

several cross street bridges over I-90/94 and I-290 considered for reconstruction. Along I-90/94, from south to north, the cross street overpasses include Taylor Street, Van Buren Street, Jackson Boulevard, and Adams Street. Along I-290, from west to east, the cross street overpasses include Morgan Street, Peoria Street, and Halsted Street.

The proposed improvements include additional through lanes in each direction on I-90/94. The horizontal alignment and vertical profiles throughout the interchange will be improved. A new two-lane flyover, Ramp NW (Flyover) will be constructed for I-90/94 northbound to I-290 westbound traffic. Cross street bridges, Morgan Street, Harrison Street, Halsted Street, Peoria Street, Taylor Street, Adams Street, Jackson Boulevard, and Van Buren Street will be reconstructed. Various existing ramps will be reconstructed and up to fifty new retaining walls will be constructed.

## **1.2 Proposed Structure**

Based on the TSL plan dated August 21, 2017 provided by TranSystems, Wang understands the proposed Mechanically Stabilized Earth (MSE) retaining wall (SN 016-1834) will be required to retain the Taylor Street Bypass Ramp Bridge (SN 016-1718) north approach roadway as well as north abutment. The 402.51-foot wall begins at Station 6405+49.34, offset 6.94 feet right on west side of Taylor Bypass Ramp, wraps the proposed Taylor Bypass Ramp Bridge north abutment, and ends at Station 6406+14.61, 23.25 feet left on east side of Taylor Bypass Ramp. The wall will have a maximum retained height of 21.5 feet. The maximum wall height measured from the top of levelling pad to the top of Coping/Finished Grade at B.F. of wall will be 25.0 feet. The wall height increases gradually from 3.5 to 25.0 feet over the length of approximately 223 feet. There will be a 3.5-foot concrete parapet on top of the wall. The TSL plan is included in the *Type Size Location Plan* (Appendix C).

## **1.3 Existing Structure**

There is no existing retaining wall structure due to a new alignment of Taylor Street Bypass Ramp Bridge.

## **2.0 SITE CONDITIONS AND GEOLOGICAL SETTING**

The site is located within the City of Chicago at the I-90/94 and I-290 Circle Interchange. On the USGS *Chicago Loop 7.5 Minute Series* map, the bridge is located in the NW<sup>1</sup>/<sub>4</sub> of Section 16, Tier 39 N, Range 14 E of the Third Principal Meridian.

The following review of published geologic data, with emphasis on factors that might influence the design and construction of the proposed engineering works, is meant to place the project area within a geological framework and confirm the dependability and consistency of the present subsurface investigation results. For the study of the regional geologic framework, Wang considered northeastern Illinois in general and Cook County in particular. Exhibit 2 illustrates the *Site and Regional Geology*.

## **2.1 Physiography**

The wall is situated within the Chicago Lake Plain Physiographic Subsection. The area is characterized by a flat surface that slopes gently toward the lake, largely made of groundmoraine till covered by thin and discontinuous lacustrine silt and clay. The ground elevation along the wall ranges from 581 feet at the south end to 589 feet at the north end.

## **2.2 Surficial Cover**

The project area was shaped during the Wisconsin-age glaciation, and more than 75-foot thick drift covers the bedrock (Leetaru et al. 2004). The glacial cover is made up of clay and silt of the Equality Formation of the Mason Group and diamictons of the Wadsworth and Lemont Formations of the Wedron Group (Hansel and Johnson 1996). The Equality Formation is made up of bedded silt and clay, locally laminated, with lenses and/or thin beds of sand and gravel. The Wadsworth Formation consists of relatively homogenous, massive, gray till with clay to silty clay matrix, with dolostone and shale clasts and occasional lenses of sorted and stratified silt. The Wadsworth Formation is underlain by the pebbly silty clay loam to silty loam diamicton of the Yorkville Member of the Lemont Formation, known informally as the Chicago “hardpan.”

From a geotechnical viewpoint, the Equality Formation is characterized by low strength, medium to high plasticity, and medium to high moisture content, whereas the Wadsworth Formation is characterized by low plasticity, medium to low moisture content, medium to very stiff consistency, poor permeability, and low compressibility. The Yorkville Member (hardpan) is characterized by low plasticity, high blow counts, and low moisture content (Bauer et al. 1991; Peck and Reed 1954).

## **2.3 Bedrock**

In the project area, the glacial deposits unconformably rest over approximately 350-foot thick Silurian-age dolostone (Leetaru et al 2004). The top of bedrock may be encountered at 475 to 500 feet elevation or 75 to 100 feet below ground surface (bgs) or more. The Silurian dolostone dips gently

eastward at a pace of 15 feet per mile. Only inactive faults are known in the area, and the seismic risk is minimal (Leetaru et al. 2004; Willman 1971). There are no records of mining activity in the area, but deep tunnel excavations are known to exist.

Our subsurface investigation results fit into the local geologic context. The borings drilled in the project area revealed the native sediments consist of clay to silty clay diamicton of the Wadsworth Formation resting on top of more competent silty clay loam diamicton (hardpan) of the Lemont Formation, which in turn is underlain by bedrock. Sound dolostone bedrock was sampled at depths of 92 to 98 feet bgs, corresponding to 484.5 to 489.4 feet elevations, within the range predicted based on published geological data.

### **3.0 METHODS OF INVESTIGATION**

The following sections outline the subsurface and laboratory investigations. All elevations in this report are based on NAVD 1988.

#### **3.1 Subsurface Investigation**

Since no specific subsurface investigation was carried out for the proposed Wall 47, Wang has referenced four structure borings, designated as 1705-B-11, 1714-B-01, 1714-B-02, 2081-B-03 drilled for the SE and NW Ramps structures and other nearby structures in March to October 2013. We have also considered one Shelby tube boring, designated as 1705-B-11A drilled adjacent to Boring 1705-B-11.

In addition, Wang considered Piezometer 1703-PZ-01 located about 600 feet east of Wall 47. The piezometer was installed in accordance with ASTM D 5092, "*Standard Practice for Design and Installation of Groundwater Monitoring Wells in Aquifers.*"

The as-drilled boring locations were surveyed by Dynasty Group, Inc. and station and offset information for each boring were provided by AECOM. The station and offset referenced the wall alignment. Boring location data are presented in the *Boring Logs* (Appendix A). The as-drilled boring locations are shown in the *Boring Location Plan* (Exhibit 3).

A truck-mounted drilling rig equipped with hollow stem augers, was used to advance and maintain an open borehole to 10 feet depth after that mud rotary was used to the boring termination depth. Soil



sampling was performed according to AASHTO T 206, "*Penetration Test and Split Barrel Sampling of Soils.*" The soil was sampled at 2.5-foot intervals to 30 feet bgs and at 5-foot intervals to boring termination depths. Soil samples collected from each sampling interval were placed in sealed jars and transported to Wang Geotechnical Laboratory in Lombard, Illinois for further examination and laboratory testing.

Field boring logs, prepared and maintained by a Wang engineer or geologist, include lithological descriptions, visual-manual soil/rock classifications, results of Rimac and pocket penetrometer unconfined compressive strength tests, results of Standard Penetration Tests (SPT) recorded as blows per 6 inches of penetration. The SPT N value, shown on the soil profile, is the sum of the second and third blows per 6 inches. The soils were described and classified according to Illinois Division of Highways (IDH) Textural Classification system. The field logs were finalized by an experienced engineering geologist after verifying the field visual classifications and laboratory test results.

Groundwater observations were made during drilling to a depth of 10 feet before using rotary wash method. Due to safety considerations, boreholes were backfilled with grout immediately upon completion. Groundwater levels in the piezometer were recorded autonomously at defined intervals by digital pressure loggers suspended within the water column. Barometric affects are compensated by a second in-air pressure logger installed in the riser pipe. Data is retrieved from loggers periodically, downloaded to computer for analysis.

### **3.2 Vane Shear Tests**

Wang performed vane shear tests in Boring VST-06. Boring VST-06 is located approximately 600 feet east of wall. Vane shear test was performed using calibrated RocTest vane shear equipment. Tests were performed in undisturbed and remolded conditions. The sensitivity shown on the borings is the ratio of shear strength in undisturbed and remolded conditions. In general, the vane shear values for soft clays were significantly higher than the corresponding values from unconfined compressive strength tests using the RIMAC apparatus. Vane shear test results were used for analyses.

### **3.3 Laboratory Testing**

The soil samples were tested in the laboratory for moisture content (AASHTO T265). Atterberg limits (AASHTO T 89/T 90) and particle size analyses (AASHTO T 88) tests were performed on selected soil samples representing the main soil layers encountered during the investigation. Shelby tube samples from Boring 1705-B-11A were tests for unconfined compressive strength (AASHTO

T208) tests. Field visual descriptions of the soil samples were verified in the laboratory. Laboratory test results are shown in the *Boring Logs* (Appendix A), in the *Soil Profile* (Exhibit 4), and in the *Laboratory Test Results* (Appendix B).

The soil samples will be retained in our laboratory for 60 days following approval of this report. After that time, soil samples will be discarded unless a specific written request is received as to their disposition.

#### **4.0 RESULTS OF FIELD AND LABORATORY INVESTIGATIONS**

Detailed descriptions of the soil conditions encountered during our subsurface investigation are presented in the attached *Boring Logs* (Appendix A) and in the *Soil Profile* (Exhibit 4). Please note that strata contact lines represent approximate boundaries between soil types. The actual transition between soil types in the field may be gradual in horizontal and vertical directions.

##### **4.1 Soil Conditions**

Boring 1714-B-02 drilled at the existing westbound I-290 shoulder encountered 4 inches of asphalt over 8 inches of concrete. Boring 2081-B-03 drilled on Halsted Street shoulder revealed 4 inches of asphalt over 11 inches of pavement. Borings 1714-B-01 and 1755-B-04 revealed 3 inches of brown to black loamy topsoil. Boring 1705-B-11 encountered 8 inches of crushed stone at the surface. In descending order, the general lithologic succession encountered beneath the pavement structure or topsoil includes: 1) man-made ground (fill); 2) medium stiff to very stiff silty clay to silty loam; 3) very soft to medium stiff clay to silty clay; 4) very stiff to hard clay to silty clay loam; 5) hard silty clay loam and dense to very dense silt to silty loam; and 6) strong dolostone.

##### *1) Man-made ground (fill)*

Underneath the topsoil or pavement structure, the borings encountered 3 to 11 feet of fill materials. Granular fill consists of loose to medium dense, crushed stone and silty loam. Cohesive fill includes stiff to hard, brown and gray silty clay to silty clay loam and clay loam. The granular fill layer has N-values of 8 to 28 blows per foot and moisture content values of 5 to 14%. The cohesive fill layer has unconfined compressive strength ( $Q_u$ ) values ranging from 1.2 to more than 4.5 tsf and moisture content values between 13 and 20%.

2) *Medium stiff to very stiff silty clay to silty loam*

Beneath the fill, at elevations of 576 to 583 feet, the borings encountered 5 to 10-foot thick of medium stiff to very stiff, brown to gray silty clay to silty loam. This layer has  $Q_u$  values ranging from 0.7 to 4.5 tsf and moisture content values between 14 and 24%. Laboratory index testing on a sample from this layer shows liquid limit ( $L_L$ ) and plastic limit ( $P_L$ ) values of 24% and 15%, respectively. This layer is commonly known as the “crust.”

3) *Very soft to medium stiff clay to silty clay*

At elevations of 568 to 572 feet (11 to 13 feet bgs), the borings revealed up to 44 feet of very soft to medium stiff, gray clay to silty clay with Rimac  $Q_u$  values of 0.08 to 0.98 tsf and moisture content values of 20 to 36%. As discussed in Section 4.2, undrained shear strength values from vane shear tests are generally higher than Rimac tests. The vane shear tests results (Boring VST-06) show corresponding  $Q_u$  values from undrained shear strength values to range from 0.6 to 1.0 tsf. Also, laboratory  $Q_u$  values from Shelby tube samples ranged from 0.52 to 1.38 tsf. Laboratory index testing results show  $L_L$  values of 33 to 34% and  $P_L$  values of 17 to 18%. According to the AASHTO soil classification, the soils belong mainly to the A-6 group. This layer is commonly known as the “Chicago Blue Clay.”

The consolidation properties of this clay to silty clay layer were obtained from nearby structure Borings 02-RWB-06ST and 1705-B-05A, and Shelby Tube 08-ST-01 located about 750 to 1500 feet away from the Wall 47. The resulting soil parameters are summarized in Table 1 and the laboratory test results are attached in Appendix B.

Table 1: Summary of Consolidation Testing

| Boring ID   | Test<br>Depth<br>(feet) | Test<br>Elevation<br>(feet) | $C_c$ | $C_s$ | $e_0$ | OCR/ $P'_c$<br>(psf) | Moisture<br>Content<br>(%) |
|-------------|-------------------------|-----------------------------|-------|-------|-------|----------------------|----------------------------|
| 02-RWB-06ST | 18 to 20                | 562.6                       | 0.240 | 0.038 | 0.747 | 1.6/3292             | 26                         |
| 1705-B-05A  | 25 to 27                | 554.2                       | 0.223 | 0.045 | 0.738 | 1.2/2886             | 26                         |
| 08-ST-01    | 39 to 41                | 545.4                       | 0.219 | 0.051 | 0.713 | 1.1/3586             | 25                         |

$C_c$ : Compression index;  $C_s$ : Swelling index ;  $e_0$ : Initial void ratio; OCR: Over consolidation ratio; and  $P'_c$ : Preconsolidation pressure.

*4) Very Stiff to hard clay to silty clay loam*

At elevations of 536 to 545 feet (36 to 52 feet bgs), the borings encountered up to 25 feet of very stiff to hard clay to silty clay loam. The clay to silty clay has  $Q_u$  values of 1.1 to 10.3 tsf with an average of 3.7 tsf and moisture content values of 11 to 24% averaging 18%. Laboratory index testing on a sample from this cohesive layer shows  $L_L$  values of 31 to 37% and a  $P_L$  value of 15 to 17%. The borings encountered 2 to 5 feet of medium dense silt and sand layers with  $N$  values of 13 to 27 blows per foot.

*(5) Hard silty clay loam and very dense silt to silty loam*

At elevations of 516 to 520 feet (62 to 77 feet bgs) the borings encountered up to 30 feet of hard silty clay loam to silty loam, dense to very dense silt to silty loam and very dense gravelly sand resting top of bedrock. This layer has  $Q_u$  values of 5.4 and 10.3 tsf, moisture content values of 14 to 24%, and  $N$  values of 46 to over 50 blows per foot. Numerous sampler refusal and hard drilling conditions were recorded within this layer.

*(6) Strong dolostone*

The borings revealed about 1.5 to 2.5 feet of weathered bedrock on top of strong bedrock. The borings encountered strong bedrock at elevations of 484.5 to 489.4 feet or 92 to 98 feet bgs. Based on the 10-foot rock core obtained from borings, the measured RQD values are 70 to 86% in Borings 1705-B-11 and 1714-B-02, and 2081-B-03 corresponding fair to good rock quality. *Bedrock core photographs* are shown in Appendix A.

## **4.2 Groundwater Conditions**

Groundwater was not observed during or after drilling in borings due to the mud rotary drilling from 10 feet bgs. A Piezometer 1703-PZ-01 was installed for the nearby structure about 550 feet east of the proposed retaining wall 47 on November 12, 2014. The screen was placed with the top and bottom elevations at 507.2 and 487.2 feet (75 to 95 feet bgs), respectively. A summary of the monitoring data between November 2014 and March 2017 is shown in Figure 1.

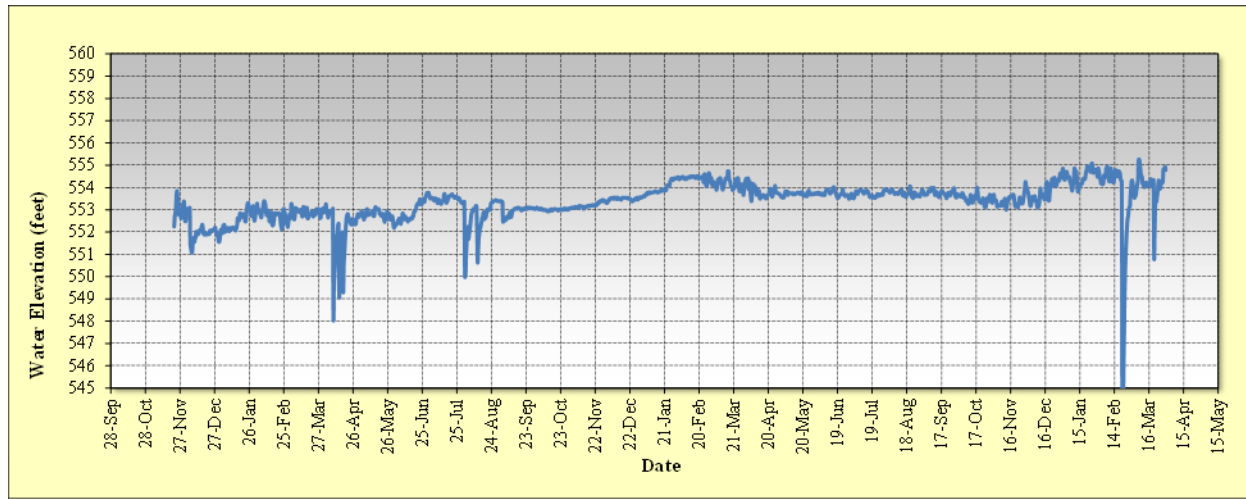

Figure 1: Summary of Groundwater Monitoring Data

The data shows groundwater that is under hydrostatic pressure head. The average hydrostatic elevation within the aquifer is about 553 feet. However, the hydrostatic pressure will not impact the proposed Wall 47 construction since the MSE wall is proposed at much higher elevations.

Although groundwater was not observed within upper fill layers, we anticipate perched water may be encountered during times of heavy precipitation. Therefore, the design and construction of the wall should consider the perched water between 576 and 580 feet elevations within the fill layers.

### 4.3 Seismic Design Considerations

The retaining wall is located in Seismic Performance Zone (SPZ) 1 and is not required to be designed for seismic forces as per 2012 IDOT *Bridge Manual* (IDOT 2012).

## 5.0 ANALYSIS AND RECOMMENDATIONS

### 5.1 Retaining Wall Type Evaluation

Based on the TSL plan, the proposed Retaining Wall 47 is a fill wall supporting the north approach of the Taylor Street Bypass Ramp Bridge. The wall will have a maximum retained height of

approximately 21.5 feet. The maximum wall height measured from the top of levelling pad to the top of Coping/Finished Grade at B.F. of wall will be 25.0 feet.

Consideration was given in using standard cast-in-place concrete cantilever (T-type) with spread footings; however, it was ruled out due to low bearing resistance and excessive settlements of foundation soils. They would need to be supported on driven piles or drilled shafts. Driven piles are not considered suitable due to noise and vibration concerns but drilled shafts placed on hardpan could be used. The proposed MSE wall is a feasible option but will require preloading or ground improvement with lightweight fill to satisfy the maximum 1-inch settlement criterion for the roadway.

The following sections present the results of our geotechnical engineering analyses and recommendations for the MSE wall design and construction.

## **5.2 Bearing Resistance and External Stability Analyses**

The MSE retaining wall base should be established a minimum of 3.5 feet below the finished grade at the front face of the wall for frost protection. Based on the TSL plan, the proposed MSE wall base elevations varies between 574.59 and 585.32 feet. Based on our boring data, the foundation soils below the MSE wall base between Stations 6406+50 and 6407+70 includes about 3 to 7 feet of medium stiff to very stiff native clayey and silty soils overlying up to 40 feet of soft to medium stiff clay to silty clay. And, between Stations 6405+49 and 6406+50 there is up to 40 feet of soft to medium stiff clay to silty clay. We estimate the foundation soils between Stations 6406+50 and 6407+70, without improvement will have a nominal bearing resistance of 3,500 psf and a factored bearing resistance of 2,300 psf. However, between Stations 6405+49 and 6406+50 a lower nominal resistance 2,500 psf and a factored bearing resistance of 1,600 psf is available. A geotechnical resistance factor of 0.65 (AASHTO 2014) was used.

We analyzed the following options to satisfy the factored bearing resistance available, external stability, and settlement. A reinforcement length equal to 70 percent of the total wall height or a minimum of 8 feet was used.

1. Using regular fill material (unit weight of 125 pcf) for the MSE wall zone and fill area;

2. Using IDOT District One Class III Lightweight Cellular Concrete Fill (LCCF) for the MSE wall zone, fill area between the walls, and an embankment fill material for the wall beyond the back to back to portion; and
3. Using option 2 with ground improvement.

For the Option 1, at the highest portion of the wall near Station 6407+69.94, the wall will apply a maximum factored equivalent bearing pressure of 6,550 psf with a regular MSE wall fill material (unit weight is 125 pcf) which exceeds the factored bearing resistance available.

In Option 2, to reduce the applied wall pressure, we have considered IDOT District One Class III LCCF with unit weight of 42 pcf for the MSE wall zone as well as fill area in the back to back wall between Stations 6406+44.75 and 6407+68.52. There are no lateral forces pushing the wall; therefore, eccentricity is not a concern. To satisfy the external stability checks, we also recommend using Class III LCCF as an embankment fill for the portion between Stations 6405+49.34 and 6406+14.61 where the wall extends beyond the back to back portion along the right wall. In addition, we recommend that the normal weight embankment behind the MSE wall system be laid back on a stable angle so it does not exert any earth pressure on the LCCF MSE wall mass nor on the LCCF material that is to be placed between the LCCF MSE mass and the laid back normal portion.

We estimate the back to back wall between Stations 6406+50 and 6407+70 with Class III LCCF will apply a maximum equivalent factored bearing pressure of 1,900 psf, thus the foundation soils will have sufficient bearing resistance to support the wall. Between Stations 6405+49 and 6407+50, we estimate the wall will apply a maximum equivalent factored pressure of 1,500 psf. We have considered Class III LCCF for the MSE wall zone, fill area between the back to back wall sections, and the embankment material beyond the back to back portion wall.

The estimated friction angle between an MSE wall base and underlying cohesive soil is 30°, and the corresponding friction coefficient is 0.58. MSE retaining walls are designed based on a geotechnical sliding resistance factor of 1.0 for soil-on-soil contact (AASHTO 2014).

### **5.3 Settlement Analyses**

We performed settlement analyses using data from Borings 1705-B-11 and 1705-B-11A since it is more conservative and closest to the maximum height of the wall near Station 6407+69. We calculated the corresponding long-term settlement of cohesive foundation soils using IDOT

*Spreadsheet for Cohesive Soils* dated December 9, 2014. The estimated maximum service pressure and long-term settlement at various locations along the wall is shown in Table 2.

Table 2: Estimated Long-Term Settlement

| Station Limits                             | Station    | Estimated<br>Maximum Total<br>Height of Wall<br>(feet) | Estimated Maximum<br>Service Pressure w/<br>Class III LCCF<br>(psf) | Estimated<br>Maximum Long-<br>Term Settlement<br>(inches) |
|--|------------|--|---|---|
| 6405+49.34 to<br>6406+14.61 <sup>(1)</sup> | 6405+93.59 | 8.9  | 400   | 0.7   |
|  | 6406+14.61 | 9.9  | 520   | 0.8   |
|  | 6406+50.00 | 13.4   | 590   | 0.9   |
| 6406+44.75 to<br>6407+76.39 <sup>(2)</sup> | 6406+75.00 | 15.9   | 690   | 1.0   |
|  | 6407+25.00 | 20.7   | 890   | 1.2   |
|  | 6407+69.94 | 25.0   | 1070  | 1.5   |

<sup>(1)</sup> Extended portion of the wall; <sup>(2)</sup> Back to Back portion of the wall.

Our settlement analyses indicate the wall will undergo about 1.5 inches of long-term settlement from the underlying cohesive soils near Station 6407+69.94 and about 1.0 inches near Station 6406+75, thus settlement governs the design. We estimate the soil will achieve 50% of primary consolidation settlement in 11 months and 90% of primary consolidation in 48 months. To reduce settlements to acceptable range of 1-inch for the roadway, we recommend either preloading for 6 months or ground improvement by use of aggregate columns.

If at least 6 months is available after construction of bypass ramp embankment and MSE Wall 47 without face panels before pavement placement, then the preloading is a viable option to reach the acceptable settlement for the roadway; however, it is our understanding that the required preloading period of 6 months may not be available due to construction constraints.

The installation of aggregate columns will create a composite material of lower overall compressibility and higher shear strength than the native soil thus increasing bearing capacity.



Aggregate columns will also increase time rate of settlement, reduce total and differential settlements, and improve slope stability (FHWA 1983). The specialty contractor should design for the equivalent uniform service pressure as provided in Table 3 at the proposed MSE wall base elevations. The estimated equivalent uniform service pressure includes a uniform surcharge of 250 psf and considers Class III LCCF (unit weight of 42 pcf) for the MSE wall reinforced zone and horizontal grade behind the wall. A factor of safety of 2.5 should be considered. Based on our settlement analyses, we estimate ground improvement will be required for both Right and Left Walls from Station 6406+30 to 6407+70. Additionally, ground improvement will be required from Station 6405+80 to 6406+30 for the Right Wall. The design and construction of aggregate columns should be as per IDOT Special Provision GBSP No. 71 *Aggregate Column Ground Improvement*.

Table 3: Estimated Equivalent Uniform Service Pressure for Aggregate Columns Design

| Limits             | Equivalent Uniform Service Pressure for Design |
|--------------------|--|
|                    | (pcf)  |
| 6405+80 to 6407+00 | 1000   |
| 6407+00 to 6407+70 | 1400   |

Alternatively, between Stations 6405+80 to 6406+75, for exposed wall heights equal to or greater than five (5) feet for the Left Wall and 3.5 feet for the Right Wall, removal and replacement of up to 5 feet may be used to Elevation 576.41 (up to 5 feet) can be considered instead of Ground improvement.

#### 5.4 Global Stability Analyses

Since Class III LCCF will be used as backfill for the MSE wall and the embankment, we do not see global instability concerns due to significant reduction of the driving forces.

### 6.0 CONSTRUCTION CONSIDERATIONS

#### 6.1 Excavation

Any required excavations should be performed in accordance with local, state, and federal regulations including current OSHA regulations. The potential effect of ground movements upon nearby

structures and utilities should be considered during construction. Any open excavation to a depth of 4 feet should have a slope of 1:2 (V:H) for cohesive soils and 1:2.5 (V:H) for granular soils or flatter.

## **6.2 Dewatering**

Based on the results of our investigation and proposed excavation for the wall, perched water is likely to be encountered during construction during times of heavy precipitation which should be removed through conventional sump and pump methods.

## **6.3 Filling and Backfilling**

All fill and backfill materials will be as per IDOT *Standard Specification for Road and Bridge Construction* (IDOT 2016).

## **6.4 Wall Construction**

The wall should be constructed as per IDOT *Standard Specification for Road and Bridge Construction* (IDOT 2016) and IDOT special provisions for *Mechanically Stabilized Earth Retaining Walls* (IDOT 2015). Class III LCCF should be as per IDOT District One special provision.

## **6.5 Construction Monitoring**

There is no need for special construction monitoring for the retaining wall except normally required by the IDOT *Standard Specification for Road and Bridge Construction* (IDOT 2016).

## **6.6 Aggregate Column Installation and Existing 84-inch Storm Sewer**

Aggregate columns for the MSE wall ground improvements may be installed before or after the installation of the abutment drilled shafts to bedrock. If the aggregate columns are installed before the drilled shafts, precautions must be taken to ensure that the installed aggregate columns are not disturbed during the subsequent shaft installations – depending on the final layout of the aggregate columns and drilled shafts, casing of the drilled shafts may be needed throughout the aggregate column depths to prevent lateral relaxation of the aggregate. If aggregate columns are installed afterwards, drilled shafts must be designed to incorporate the additional lateral stresses induced by the aggregate column installation.

The east end of the MSE wall 47 ground improvements are nearby to the existing 84-inch storm sewer tunnel. Precautions must be taken in order not to overstress the existing tunnel walls during the

aggregate column installation. The Contractor should submit a plan for protecting and monitoring the sewer tunnel during the aggregate column installations.

## 7.0 QUALIFICATIONS

The analysis and recommendations submitted in this report are based upon the data obtained from the borings drilled at the locations shown on the boring logs and in Exhibit 3. This report does not reflect any variations that may occur between the borings or elsewhere on the site, variations whose nature and extent may not become evident until the course of construction. In the event that any changes in the design and/or location of Retaining Wall 47 (SN016-1834) are planned, we should be timely informed so that our recommendations can be adjusted accordingly.

It has been a pleasure to assist AECOM and the Illinois Department of Transportation on this project. Please call if there are any questions, or if we can be of further service.

Respectfully Submitted,

WANG ENGINEERING, INC. *Exp. 11/30/2019*

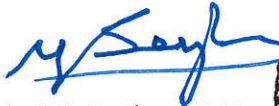
  
Metin W. Seyhun, P.E.  
Senior Geotechnical Engineer



  
Corina T. Farez, P.E., P.G.  
Vice President

  
Nesam S. Balakumaran  
Project Geotechnical Engineer

---

## ***REFERENCES***

- AMERICAN ASSOCIATION OF STATE HIGHWAY TRANSPORTATION OFFICIALS (2014) *LRFD Bridge Design Specifications*. United States Department of Transportation, Washington, D.C.
- BAUER, R.A., CURRY, B.B., GRAESE, A.M., VAIDEN, R.C., SU, W.J., and HASEK, M.J., 1991, *Geotechnical Properties of Selected Pleistocene, Silurian, and Ordovician Deposits of Northeastern Illinois*: Environmental Geology 139, Illinois State Geological Survey, 69 p.
- HANSEL, A.K., and JOHNSON, W.H. (1996) *Wedron and Mason Groups: Lithostratigraphic Reclassification of the Wisconsin Episode, Lake Michigan Lobe Area: ISGS Bulletin 104*. Illinois State Geological Survey, Champaign, IL. 116 p.
- LEETARU, H.E., SARGENT, M.L., AND KOLATA, D.R., 2004, *Geologic Atlas of Cook County for Planning Purposes*, ISGS, Champaign, IL
- ILLINOIS DEPARTMENT OF TRANSPORTATION (2015) *Geotechnical Manual*. IDOT Bureau of Materials and Physical Research, Springfield, IL.
- ILLINOIS DEPARTMENT OF TRANSPORTATION (2016) *Standard Specifications for Road and Bridge Construction*. IDOT Division of Highways, Springfield, IL.
- ILLINOIS DEPARTMENT OF TRANSPORTATION (2012) *Bridge Manual*. IDOT Bureau of Bridges and Structures, Springfield, IL.
- WILLMAN, H.B., 1971, *Summary of the Geology of the Chicago Area*, ISGS Circular C460: Urbana, Illinois State Geological Survey, p. 77.
- PECK, R.B., and REED, W.C., 1954, *Engineering Properties of Chicago Subsoils*: University of Illinois Engineering Experiment Station Bulletin No. 423: Urbana, University of Illinois, 62 p.
- FEDERAL HIGHWAY ADMINISTRATION (1983) *Design and Construction of Stone Columns Vol 1*. US Department of Transportation Report No. FHWA/RD-83/026, McLean, Virginia.

## **EXHIBITS**

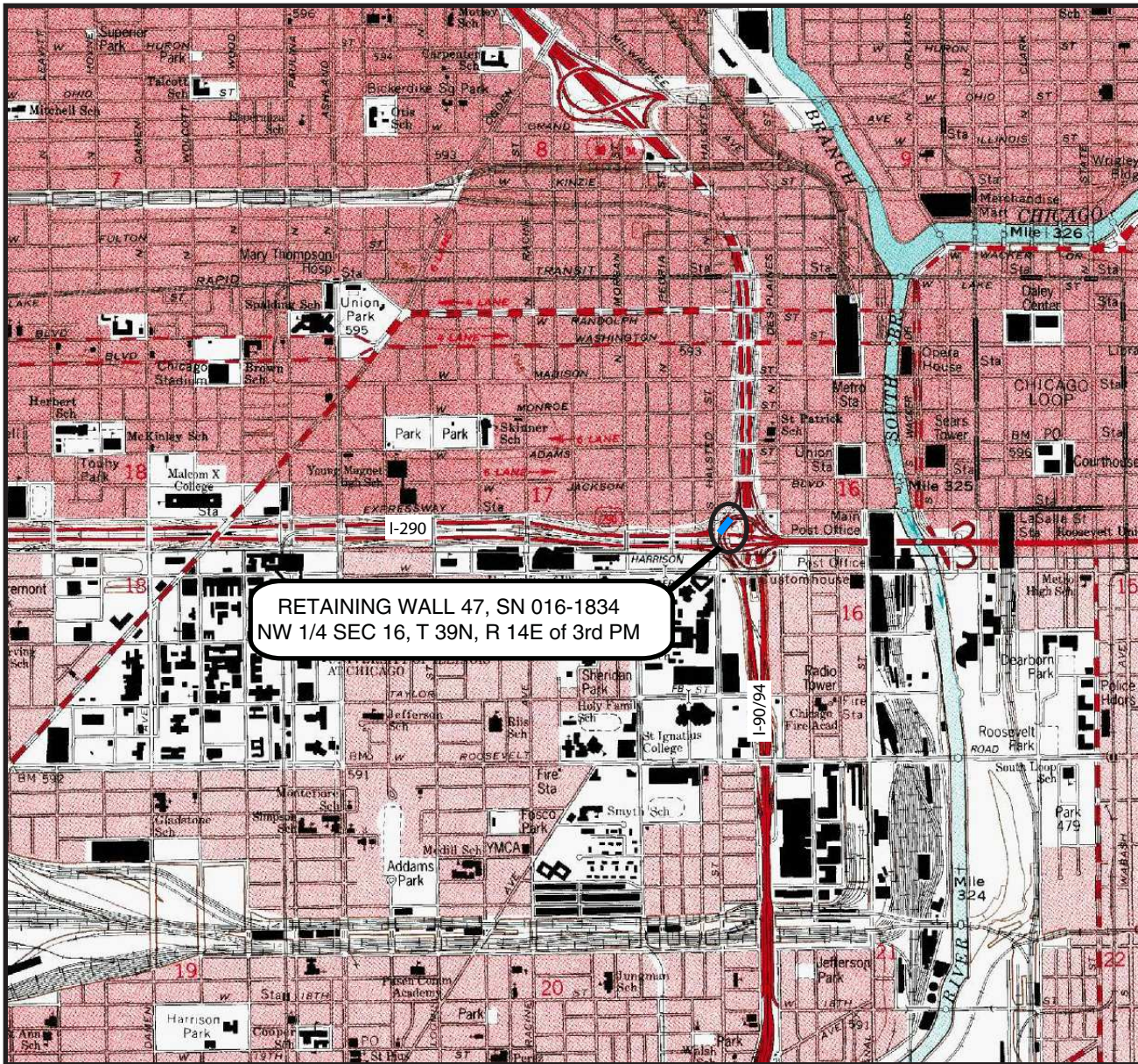

RETAINING WALL 47, SN 016-1834  
NW 1/4 SEC 16, T 39N, R 14E of 3rd PM

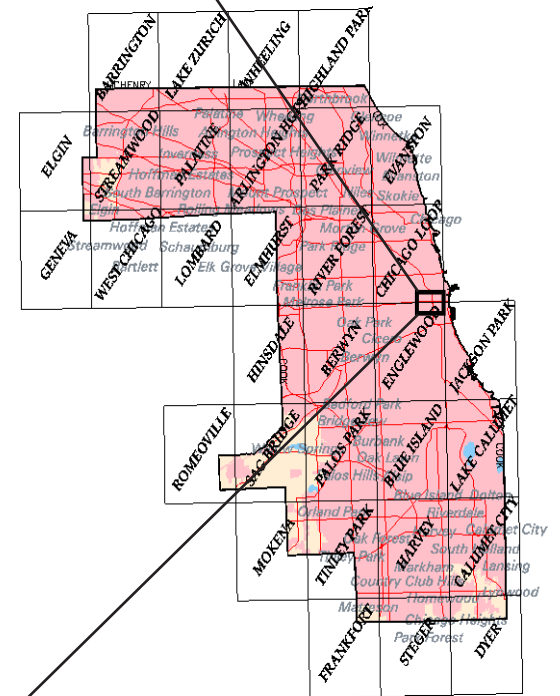

Cook County

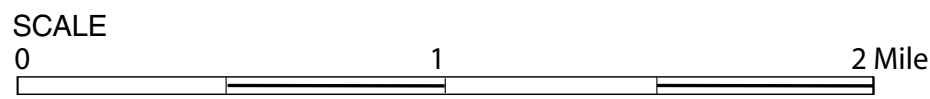

SITE LOCATION MAP: CIRCLE INTERCHANGE RECONSTRUCTION, RETAINING WALL 47, SN 016-1834, COOK COUNTY

SCALE: GRAPHICAL | EXHIBIT 1 | DRAWN BY: RKC | CHECKED BY: NSB



1145 N. Main Street  
Lombard, IL 60148  
www.wangeng.com

FOR AECOM

1100-04-01

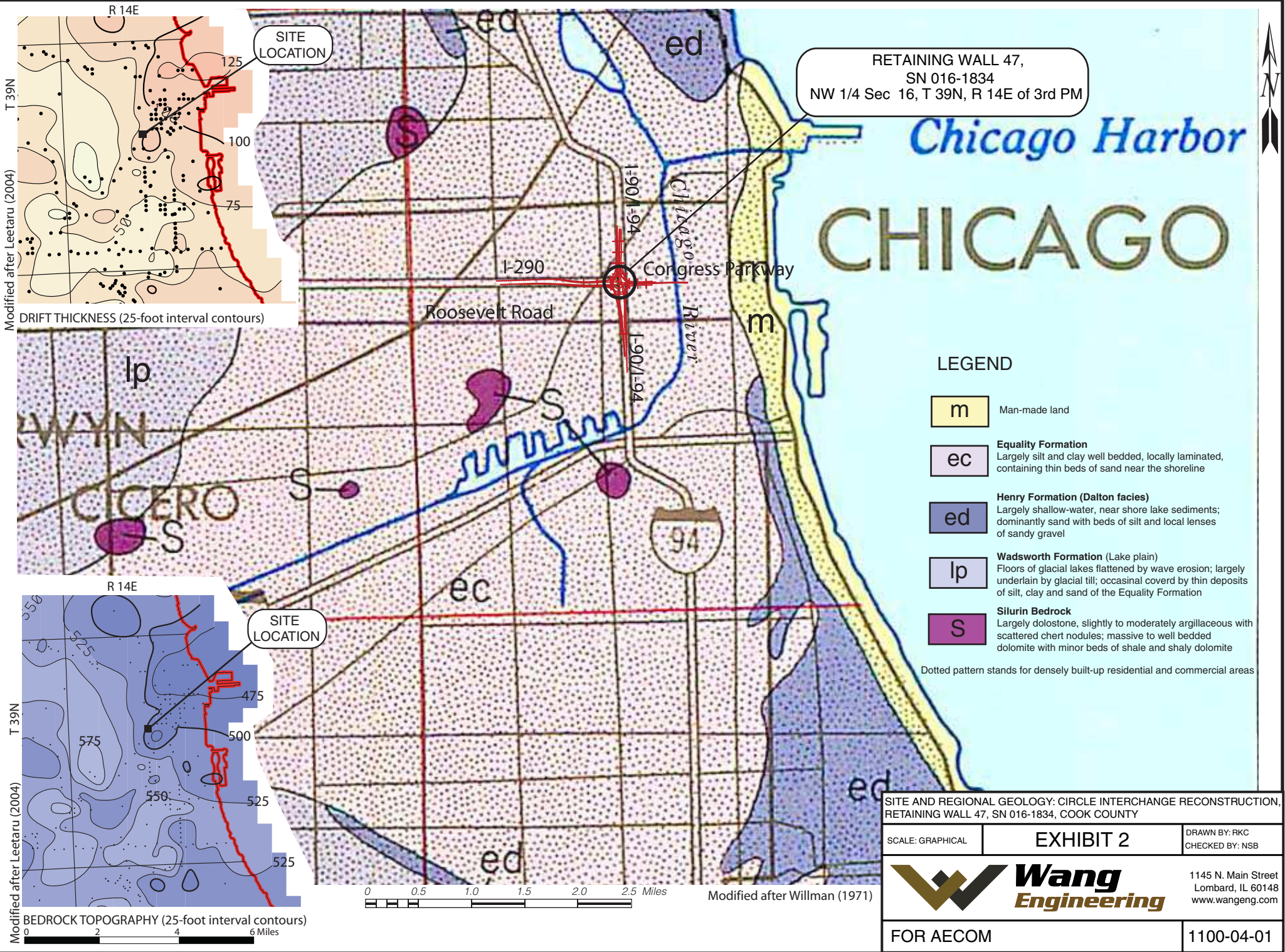

RETAINING WALL 47,  
SN 016-1834  
NW 1/4 Sec 16, T 39N, R 14E of 3rd PM

# Chicago Harbor

# CHICAGO

### LEGEND

- m Man-made land
  - ec **Equality Formation**  
Largely silt and clay well bedded, locally laminated, containing thin beds of sand near the shoreline
  - ed **Henry Formation (Dalton facies)**  
Largely shallow-water, near shore lake sediments; dominantly sand with beds of silt and local lenses of sandy gravel
  - lp **Wadsworth Formation (Lake plain)**  
Floors of glacial lakes flattened by wave erosion; largely underlain by glacial till; occasional cover by thin deposits of silt, clay and sand of the Equality Formation
  - S **Silurin Bedrock**  
Largely dolostone, slightly to moderately argillaceous with scattered chert nodules; massive to well bedded dolomite with minor beds of shale and shaly dolomite
- Dotted pattern stands for densely built-up residential and commercial areas

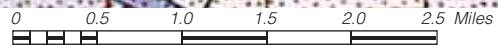
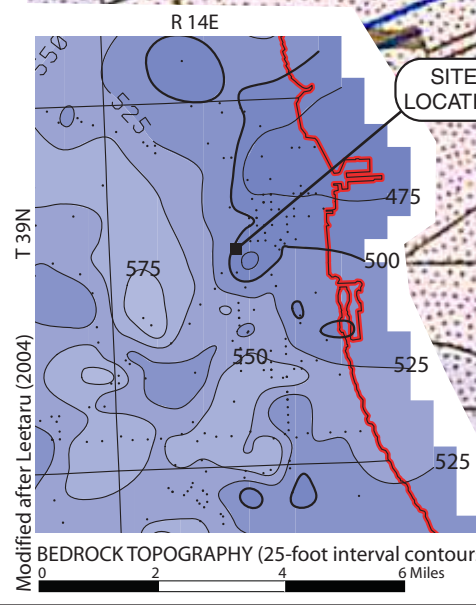
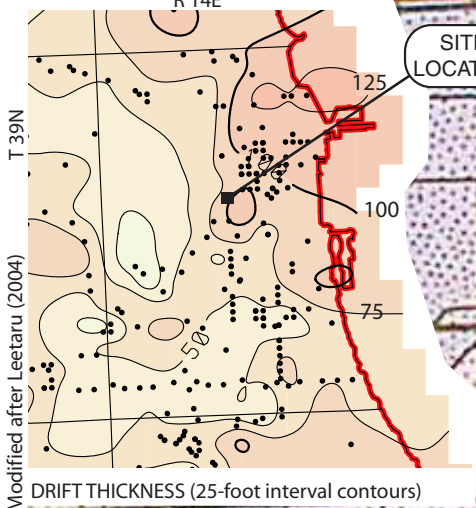

Modified after Willman (1971)

SITE AND REGIONAL GEOLOGY: CIRCLE INTERCHANGE RECONSTRUCTION, RETAINING WALL 47, SN 016-1834, COOK COUNTY

|                  |           |                                  |
|------------------|-----------|----------------------------------|
| SCALE: GRAPHICAL | EXHIBIT 2 | DRAWN BY: RKC<br>CHECKED BY: NSB |
|------------------|-----------|----------------------------------|

**Wang Engineering**

1145 N. Main Street  
Lombard, IL 60148  
www.wangeng.com

|           |            |
|-----------|------------|
| FOR AECOM | 1100-04-01 |
|-----------|------------|

Bench Mark: Chisel "X" on chain bolt of fire hydrant in front of 555 W. Harrison St. Elev. 594.46.

Existing Structure: None.

The existing bridge will be closed and traffic will be detoured during construction. Traffic on I-290 and I-90/94 will be maintained with stage construction.

No Salvage.

**NOTES:**

1. Wall offsets are measured from the  $\text{\textcircled{B}}$  of Taylor St. Bypass Ramp to the front face of precast panels.
2. F.F. denotes Front Face.
3. B.F. denotes Back Face.
4. Aggregate columns must be spaced to avoid interference with existing utilities to remain, proposed utilities to be installed, and proposed abutment foundation.
5. All proposed drainage structure locations along I-90/94 are conceptual at this stage and are subject to refinement during final design.

**HIGHWAY CLASSIFICATION**

| SB I-90/94 Taylor St. Bypass Ramp | Ramp NW                           |
|-----------------------------------|-----------------------------------|
| Functional Class: Interstate      | Functional Class: Interstate      |
| ADT: NA (2012); 8,000 (2040)      | ADT: 32,500 (2012); 36,000 (2040) |
| ADTT: NA (2012); 240 (2040)       | ADTT: 2,483 (2012); 2,730 (2040)  |
| DHV: 590 (2040)                   | DHV: 2,790 (2040)                 |
| Design Speed: 25 m.p.h.           | Design Speed: 35 m.p.h.           |
| Posted Speed: 25 m.p.h.           | Posted Speed: 35 m.p.h.           |
| One-Way Traffic                   | One-Way Traffic                   |
| Directional Distribution: 100%    | Directional Distribution: 100%    |

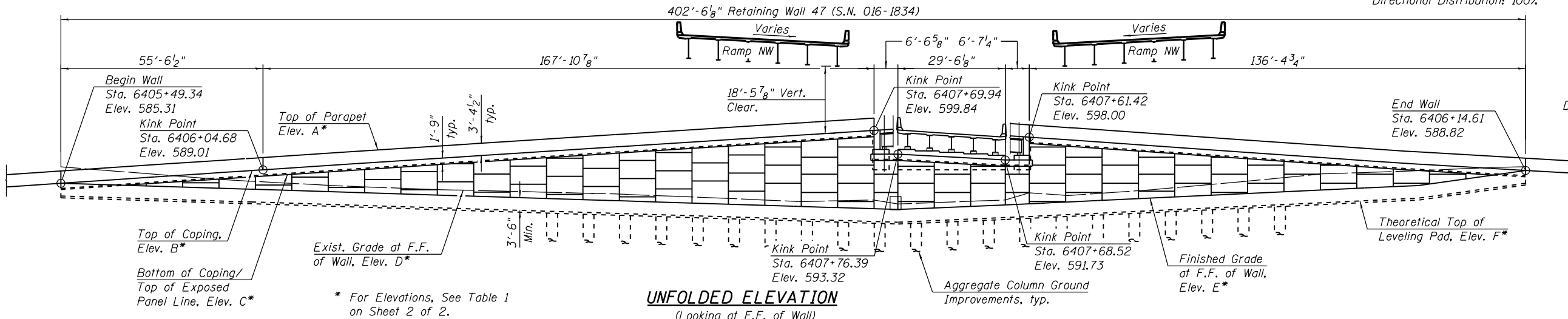

**DESIGN SPECIFICATIONS**

2014 AASHTO LRFD Bridge Design Specifications 7th Edition with 2015 and 2016 Interim Specifications

**DESIGN STRESSES**

**FIELD UNITS**

f'c = 3,500 psi  
fy = 60,000 psi (Reinforcement)

**PRECAST UNITS**

f'c = 4,500 psi

**LEGEND**

|   |                     |
|---|---------------------|
| Electric  | — E —               |
| Fiber Optic   | — FO —              |
| Exist. Storm Sewer                                    | — S —               |
| Light Pole  | ⊙                   |
| Soil Boring   | ⊕                   |
| Limits of Soil Reinforcement                          | [Hatched Box]       |
| Limits of Soil Reinforcement With Ground Improvements | [Cross-hatched Box] |

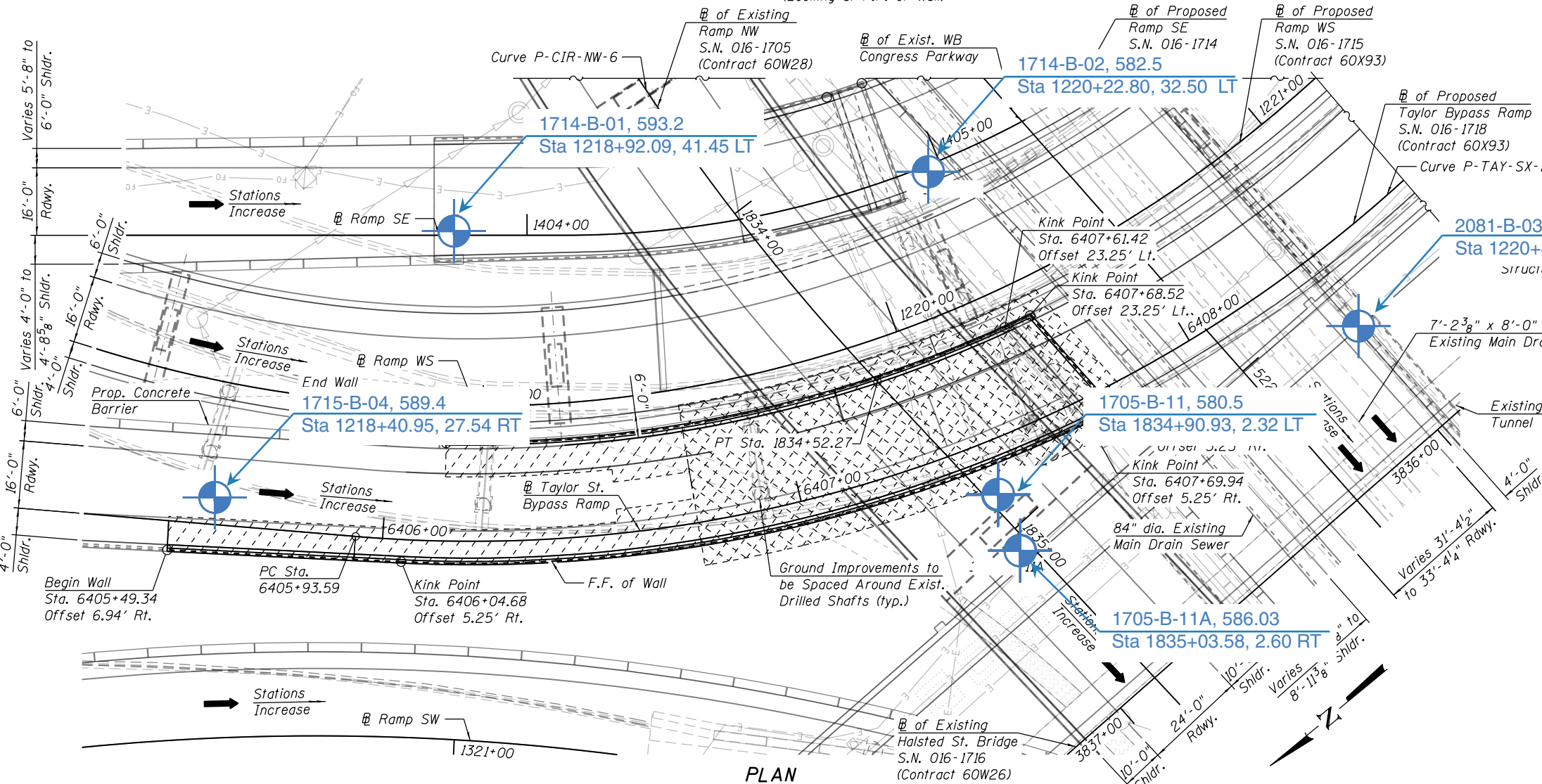
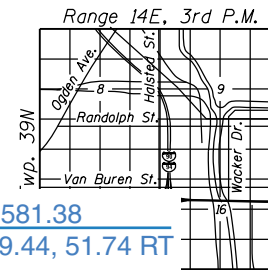

**GENERAL PLAN**  
RETAINING WALL 47 ALONG  
F.A.I 94 (SB I-90/94 TAYLOR ST. BYPASS RAMP)  
SECTION 2014-013 R&B-R  
COOK COUNTY  
STATION 6405+49.34 TO STATION 6407+76.39  
STRUCTURE NO. 016-1834

BORING LOCATION PLAN: CIRCLE INTERCHANGE RECONSTRUCTION  
RETAINING WALL 47, SN 016-1834, COOK COUNTY

|                  |                  |   |
|------------------|------------------|---|
| SCALE: GRAPHICAL | <b>EXHIBIT 3</b> | DRAWN BY: RKC<br>CHECKED BY: NSB                            |
|                  |                  | 1145 N. Main Street<br>Lombard, IL 60148<br>www.wangeng.com |
| FOR AECOM        |                  | 1100-04-01  |



|                           |               |           |
|---------------------------|---------------|-----------|
| USER NAME = jrmickens     | DESIGNED - JM | REVISED - |
| PLOT SCALE = 32.00' / in. | CHECKED - WJC | REVISED - |
| PLOT DATE = 8/21/2017     | DRAWN - JM    | REVISED - |
|                           | CHECKED - TLR | REVISED - |

STATE OF ILLINOIS  
DEPARTMENT OF TRANSPORTATION

| F.A.I. RTE.        | SECTION        | COUNTY | TOTAL SHEETS              | SHEET NO. |
|--------------------|----------------|--------|---------------------------|-----------|
| 90/94/290          | 2014-013 R&B-R | COOK   | 3                         | 1         |
| CONTRACT NO. 60X93 |                |        | ILLINOIS FED. AID PROJECT |           |



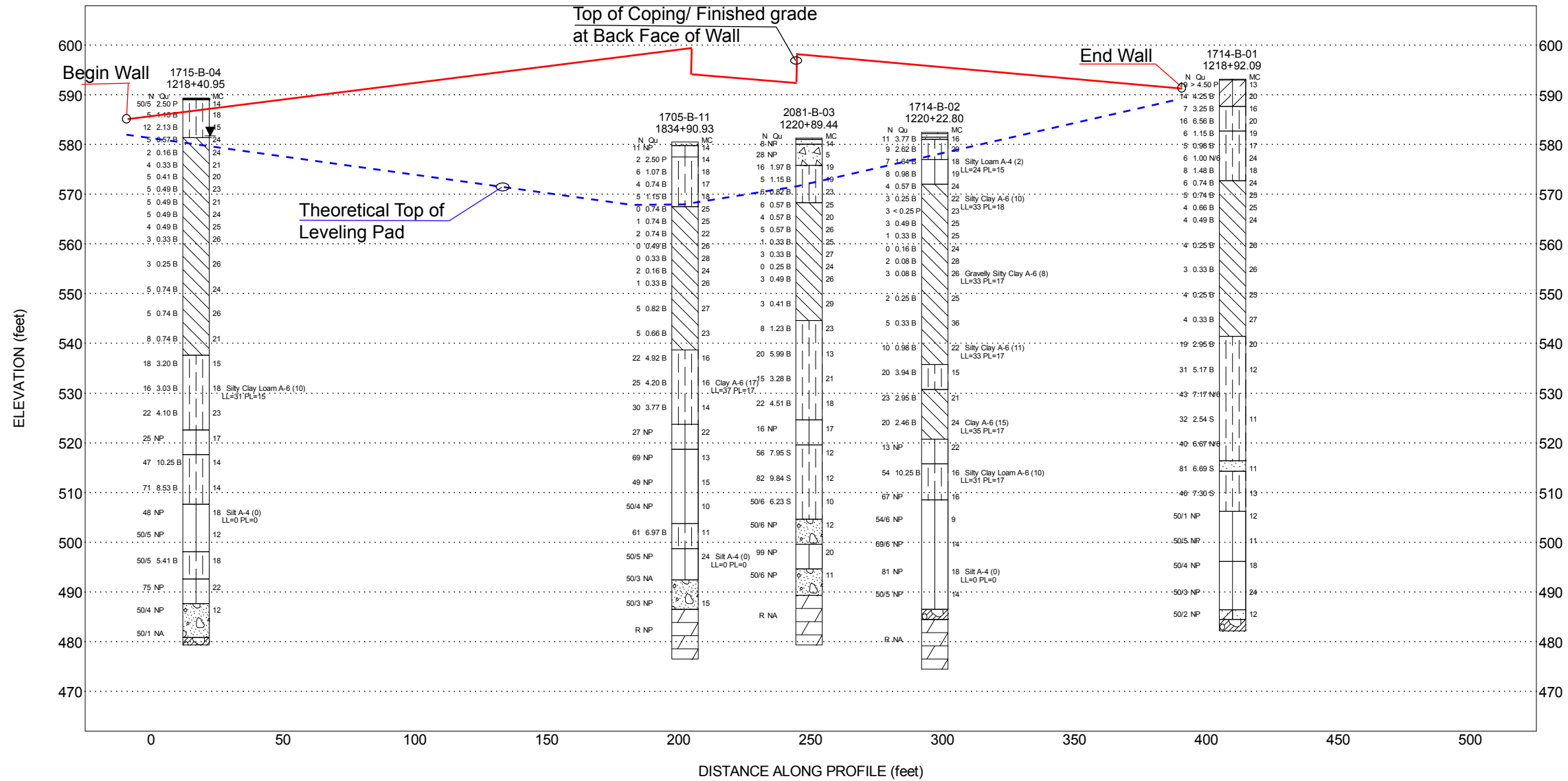
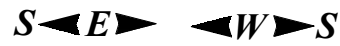

**Lithology Graphics**

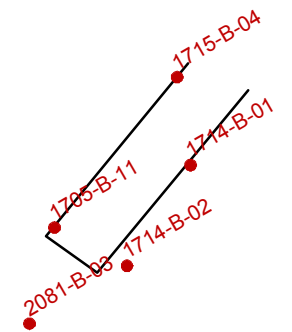
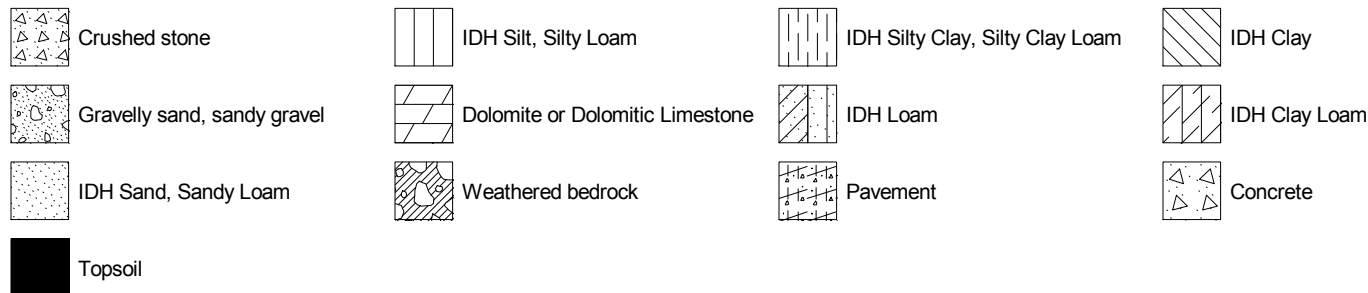

Site Map Scale 1 inch equals 185 feet

**Explanation:**

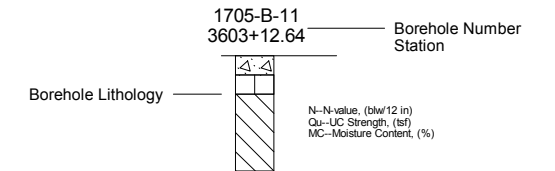

- Water Level Reading at time of drilling.
- Water Level Reading 24-hr after drilling or at end of drilling

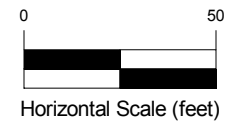

Vertical Exaggeration: 2x

**Wang Engineering, Inc.**  
1145 N Main Street  
Lombard, IL 60148

**Subsurface Soil Data Profile  
Retaining Wall 47; SN 016-1834**



Circle Interchange Reconstruction  
Section 17, T39N, R14E of 3rd PM

|            |              |
|------------|--------------|
| JOB NUMBER | PLATE NUMBER |
| 1100-04-01 | EXHIBIT 4    |

## **APPENDIX A**



# BORING LOG 08-ST-01

wangeng@wangeng.com  
 1145 N. Main Street  
 Lombard/IL/60148  
 Telephone: 6309539928  
 Fax: 6309539938

WEI Job No.: 1100-04-01

Client: **AECOM**  
 Project: **Circle Interchange Reconstruction**  
 Location: **Section 17, T39N, R14E of 3rd PM**

Datum: NAVD 88  
 Elevation: 585.42 ft  
 North: 1899122.49 ft  
 East: 1171372.69 ft  
 Station: 1312+06.92  
 Offset: 7.0183 RT

| Profile | Elevation (ft) | SOIL AND ROCK DESCRIPTION   | Depth (ft) | Sample Type recovery | Sample No. | SPT Values (blw/6 in) | Qu (tsf)    | Moisture Content (%) | Profile | Elevation (ft) | SOIL AND ROCK DESCRIPTION | Depth (ft) | Sample Type recovery | Sample No. | SPT Values (blw/6 in) | Qu (tsf)    | Moisture Content (%) |
|---------|----------------|---|------------|----------------------|------------|-----------------------|-------------|----------------------|---------|----------------|---------------------------|------------|----------------------|------------|-----------------------|-------------|----------------------|
|         | 585.14         | 14-inch thick, black SILTY CLAY LOAM                                  |            |                      |            |                       |             |                      |         |                |                           |            |                      |            |                       |             |                      |
|         |                | --TOPSOIL--<br>Very stiff, brown SILTY CLAY LOAM, little gravel; damp |            |                      | 1          | 3<br>4<br>9           | 2.75<br>P   | 10                   |         |                |                           |            |                      | 5          | P<br>U<br>S<br>H      | < 0.25<br>P | 24                   |
|         |                | --FILL--  |            |                      |            |                       |             |                      |         |                |                           |            |                      |            |                       |             |                      |
|         | 581.2          | Soft to medium stiff, gray CLAY to SILTY CLAY, trace gravel; moist    | 5          |                      | 2          | 2<br>2<br>3           | 0.83<br>N/6 |                      |         |                |                           |            |                      | 6          | P<br>U<br>S<br>H      | < 0.25<br>P | 24                   |
|         |                |   |            |                      | 3          | 1<br>2<br>2           | 0.25<br>P   | 25                   |         |                |                           |            |                      | 7          | P<br>U<br>S<br>H      | 0.25<br>P   | 24                   |
|         |                |   | 10         |                      | 1          |                       |             |                      |         |                |                           |            |                      | 8          | P<br>U<br>S<br>H      | 0.50<br>P   | 23                   |
|         |                | --S <sub>u</sub> = 0.43 tsf (UU TXC)<br>--w <sub>n</sub> (%)=23       |            |                      | 2          |                       |             |                      |         |                |                           |            |                      | 9          | P<br>U<br>S<br>H      | 0.25<br>P   | 25                   |
|         |                |   | 15         |                      | 3          |                       |             |                      |         |                |                           |            |                      | 10         | P<br>U<br>S<br>H      | 0.50<br>P   | 23                   |
|         |                | --S <sub>u</sub> = 0.29 tsf (UU TXC)<br>--w <sub>n</sub> (%)=24       | 20         |                      | 4          |                       |             |                      |         |                |                           |            |                      |            | P<br>U                |             |                      |
|         |                |   |            |                      |            |                       |             |                      |         |                |                           |            |                      |            |                       |             |                      |

### GENERAL NOTES

### WATER LEVEL DATA

Begin Drilling **11-03-2014** Complete Drilling **11-03-2014**  
 Drilling Contractor **Wang Testing Services** Drill Rig  
 Driller **P&P** Logger **F. Bozga** Checked by **C. Marin**  
 Drilling Method **3.25" HSA, boring backfilled upon completion**

While Drilling **DRY**  
 At Completion of Drilling **NA**  
 Time After Drilling **NA**  
 Depth to Water **NA**

The stratification lines represent the approximate boundary between soil types; the actual transition may be gradual.

WANGENGINC 11000401.GPJ WANGENG.GDT 1/11/18



# BORING LOG 08-ST-01

wangeng@wangeng.com  
 1145 N. Main Street  
 Lombard/IL/60148  
 Telephone: 6309539928  
 Fax: 6309539938

WEI Job No.: 1100-04-01

Client **AECOM**  
 Project **Circle Interchange Reconstruction**  
 Location **Section 17, T39N, R14E of 3rd PM**

Datum: NAVD 88  
 Elevation: 585.42 ft  
 North: 1899122.49 ft  
 East: 1171372.69 ft  
 Station: 1312+06.92  
 Offset: 7.0183 RT

| Profile | Elevation (ft) | SOIL AND ROCK DESCRIPTION  | Depth (ft) | Sample Type recovery | Sample No. | SPT Values (blw/6 in) | Qu (tsf)  | Moisture Content (%) | Profile | Elevation (ft) | SOIL AND ROCK DESCRIPTION | Depth (ft) | Sample Type recovery | Sample No. | SPT Values (blw/6 in) | Qu (tsf) | Moisture Content (%) |
|---------|----------------|--|------------|----------------------|------------|-----------------------|-----------|----------------------|---------|----------------|---------------------------|------------|----------------------|------------|-----------------------|----------|----------------------|
|         |                |  |            |                      | 11         | S<br>H                | 0.50<br>P | 26                   |         |                |                           |            |                      |            |                       |          |                      |
|         |                | --Laboratory $Q_u=0.39$ tsf (B),<br>$w_n(\%)=21$ --  |            |                      | 12         | P<br>U<br>S<br>H      | 0.25<br>P | 25                   |         |                |                           |            |                      |            |                       |          |                      |
|         |                | --Laboratory $Q_u=0.19$ tsf (B),<br>$w_n(\%)=25$ --  | 45         |                      | 13         | P<br>U<br>S<br>H      | 0.75<br>P | 25                   |         |                |                           |            |                      |            |                       |          |                      |
|         | 537.9          | Very stiff, gray SILTY CLAY<br>LOAM, trace gravel; damp<br>--Laboratory $Q_u=3.31$ tsf (B),<br>$w_n(\%)=19$ -- |            |                      | 14         | P<br>U<br>S<br>H      | 3.25<br>P | 19                   |         |                |                           |            |                      |            |                       |          |                      |
|         |                |  | 50         |                      |            |                       |           |                      |         |                |                           |            |                      |            |                       |          |                      |
|         | 532.9          |  |            |                      | 4          | 5<br>8<br>12          | 3.85<br>B | 20                   |         |                |                           |            |                      |            |                       |          |                      |
|         |                | Boring terminated at 51.50 ft  |            |                      |            |                       |           |                      |         |                |                           |            |                      |            |                       |          |                      |
|         |                |  | 55         |                      |            |                       |           |                      |         |                |                           |            |                      |            |                       |          |                      |
|         |                |  | 60         |                      |            |                       |           |                      |         |                |                           |            |                      |            |                       |          |                      |

### GENERAL NOTES

### WATER LEVEL DATA

Begin Drilling **11-03-2014** Complete Drilling **11-03-2014**  
 Drilling Contractor **Wang Testing Services** Drill Rig  
 Driller **P&P** Logger **F. Bozga** Checked by **C. Marin**  
 Drilling Method **3.25" HSA, boring backfilled upon completion**

While Drilling  $\nabla$  **DRY**  
 At Completion of Drilling  $\nabla$  **NA**  
 Time After Drilling **NA**  
 Depth to Water  $\nabla$  **NA**

The stratification lines represent the approximate boundary between soil types; the actual transition may be gradual.



wangeng@wangeng.com  
 1145 N. Main Street  
 Lombard/IL/60148  
 Telephone: 6309539928  
 Fax: 6309539938

# BORING LOG 1705-B-05A

WEI Job No.: 1100-04-01

Client **AECOM**  
 Project **Circle Interchange Reconstruction**  
 Location **Section 17, T39N, R14E of 3rd PM**

Datum: NAVD 88  
 Elevation: 580.24 ft  
 North: 1897604.27 ft  
 East: 1171792.75 ft  
 Station: 1825+76.08  
 Offset: 3.9157 RT

| Profile | Elevation (ft) | SOIL AND ROCK DESCRIPTION   | Depth (ft) | Sample Type recovery | Sample No. | SPT Values (blw/6 in) | Qu (tsf) | Moisture Content (%) | Profile | Elevation (ft) | SOIL AND ROCK DESCRIPTION | Depth (ft) | Sample Type recovery | Sample No. | SPT Values (blw/6 in) | Qu (tsf) | Moisture Content (%) |
|---------|----------------|---|------------|----------------------|------------|-----------------------|----------|----------------------|---------|----------------|---------------------------|------------|----------------------|------------|-----------------------|----------|----------------------|
|         |                | --Blind drilled--   |            |                      |            |                       |          |                      |         |                |                           |            |                      |            |                       |          |                      |
|         | 571.2          | SILTY CLAY LOAM<br>--L <sub>L</sub> (%)=31, P <sub>L</sub> (%)=17--<br>--%Gravel=4.4--<br>--%Sand=18.7--<br>--%Silt=48.3--<br>--%Clay=28.6--<br>--A-6 (9)--   | 10         | Vertical Lines       | 1          | PUSH                  |          | 26                   |         |                |                           |            |                      |            |                       |          |                      |
|         | 566.2          | Soft to medium stiff, gray CLAY to SILTY CLAY, trace gravel<br>--L <sub>L</sub> (%)=34, P <sub>L</sub> (%)=17--<br>--%Gravel=4.2--<br>--%Sand=13.9--<br>--%Silt=49.8--<br>--%Clay=32.1--<br>--A-6 (13)--<br>--L <sub>L</sub> (%)=32, P <sub>L</sub> (%)=17--<br>--%Gravel=2.9--<br>--%Sand=14.3--<br>--%Silt=50.9--<br>--%Clay=31.9--<br>--A-6 (11)-- | 15         | Vertical Lines       | 2          | PUSH                  | 0.33 B   | 24                   |         |                |                           |            |                      |            |                       |          |                      |
|         |                |   | 25         | Vertical Lines       | 3          | PUSH                  |          |                      |         |                |                           |            |                      |            |                       |          |                      |
|         |                |   | 35         | Diagonal Lines       | 13         |                       |          |                      |         |                |                           |            |                      |            |                       |          |                      |
|         |                |   | 40         | Diagonal Lines       | 14         |                       |          |                      |         |                |                           |            |                      |            |                       |          |                      |

### GENERAL NOTES

Begin Drilling **07-23-2013** Complete Drilling **07-24-2013**  
 Drilling Contractor **Wang Testing Services** Drill Rig  
 Driller **R&N** Logger **A. Happel** Checked by **C. Marin**  
 Drilling Method **2.25" SSA to 10', mud rotary thereafter, boring backfilled upon completion**

### WATER LEVEL DATA

While Drilling  **Rotary wash**  
 At Completion of Drilling  **mud in the borehole**  
 Time After Drilling **NA**  
 Depth to Water  **NA**

The stratification lines represent the approximate boundary between soil types; the actual transition may be gradual.

WANGENGINC 11000401.GPJ WANGENG.GDT 1/11/18



wangeng@wangeng.com  
 1145 N. Main Street  
 Lombard/IL/60148  
 Telephone: 6309539928  
 Fax: 6309539938

# BORING LOG 1705-B-05A

WEI Job No.: 1100-04-01

Client: **AECOM**  
 Project: **Circle Interchange Reconstruction**  
 Location: **Section 17, T39N, R14E of 3rd PM**

Datum: NAVD 88  
 Elevation: 580.24 ft  
 North: 1897604.27 ft  
 East: 1171792.75 ft  
 Station: 1825+76.08  
 Offset: 3.9157 RT

| Profile | Elevation (ft) | SOIL AND ROCK DESCRIPTION  | Depth (ft) | Sample Type recovery | Sample No. | SPT Values (blw/6 in) | Qu (tsf)  | Moisture Content (%) | Profile | Elevation (ft) | SOIL AND ROCK DESCRIPTION   | Depth (ft) | Sample Type recovery | Sample No. | SPT Values (blw/6 in) | Qu (tsf)  | Moisture Content (%) |
|---------|----------------|--|------------|----------------------|------------|-----------------------|-----------|----------------------|---------|----------------|---|------------|----------------------|------------|-----------------------|-----------|----------------------|
|         | 538.5          |  |            |                      |            |                       |           |                      |         | 518.5          |   |            |                      |            |                       |           |                      |
|         |                | Hard, gray SILTY CLAY, trace gravel  | 45         | X                    | 15         | 7<br>12<br>17         | 5.44<br>B | 19                   |         |                | Medium dense, gray SANDY LOAM<br>--possible groundwater bearing--             | 65         | X                    | 19         | 8<br>10<br>13         | NP        | 25                   |
|         |                |  | 50         | X                    | 16         | 8<br>12<br>20         | 5.40<br>B | 15                   |         |                | Very stiff to hard, gray SILTY CLAY LOAM, trace gravel                        | 70         | X                    | 20         | 10<br>48<br>50/4      | 2.46<br>S | 12                   |
|         |                |  | 55         | X                    | 17         | 7<br>15<br>20         | 5.74<br>B | 17                   |         |                |   | 75         | X                    | 21         | 21<br>30<br>31        | 6.81<br>B | 13                   |
|         | 523.5          | Stiff, gray CLAY<br>--L <sub>L</sub> (%)=53, P <sub>L</sub> (%)=21--<br>--%Gravel=0.5--<br>--%Sand=2.9--<br>--%Silt=34.0--<br>--%Clay=62.6--<br>--A-7-6 (34)--60 |            | X                    | 18         | 5<br>5<br>5           | 1.15<br>B | 34                   |         |                | Very dense, gray SILTY LOAM, trace gravel<br>--possible groundwater bearing-- | 80         | X                    | 22         | 50/6                  | NP        | 20                   |

### GENERAL NOTES

### WATER LEVEL DATA

Begin Drilling **07-23-2013** Complete Drilling **07-24-2013**  
 Drilling Contractor **Wang Testing Services** Drill Rig  
 Driller **R&N** Logger **A. Happel** Checked by **C. Marin**  
 Drilling Method **2.25" SSA to 10', mud rotary thereafter, boring**  
**backfilled upon completion**

While Drilling **Rotary wash**  
 At Completion of Drilling **mud in the borehole**  
 Time After Drilling **NA**  
 Depth to Water **NA**

The stratification lines represent the approximate boundary between soil types; the actual transition may be gradual.

WANGENGINC 11000401.GPJ WANGENG.GDT 1/11/18



wangeng@wangeng.com  
 1145 N. Main Street  
 Lombard/IL/60148  
 Telephone: 6309539928  
 Fax: 6309539938

# BORING LOG 1705-B-05A

WEI Job No.: 1100-04-01

Client ..... **AECOM** .....  
 Project ..... **Circle Interchange Reconstruction** .....  
 Location ..... **Section 17, T39N, R14E of 3rd PM** .....

Datum: NAVD 88  
 Elevation: 580.24 ft  
 North: 1897604.27 ft  
 East: 1171792.75 ft  
 Station: 1825+76.08  
 Offset: 3.9157 RT

| Profile | Elevation (ft) | SOIL AND ROCK DESCRIPTION                          | Depth (ft) | Sample Type recovery | Sample No. | SPT Values (blw/6 in) | Qu (tsf) | Moisture Content (%) | Profile | Elevation (ft) | SOIL AND ROCK DESCRIPTION | Depth (ft) | Sample Type recovery | Sample No. | SPT Values (blw/6 in) | Qu (tsf) | Moisture Content (%) |
|---------|----------------|--|------------|----------------------|------------|-----------------------|----------|----------------------|---------|----------------|---------------------------|------------|----------------------|------------|-----------------------|----------|----------------------|
|         | 497.2          | --AUGER REFUSAL--<br>Boring terminated at 83.00 ft | 85         |                      |            |                       |          |                      |         |                |                           |            |                      |            |                       |          |                      |
|         |                |  | 90         |                      |            |                       |          |                      |         |                |                           |            |                      |            |                       |          |                      |
|         |                |  | 95         |                      |            |                       |          |                      |         |                |                           |            |                      |            |                       |          |                      |
|         |                |  | 100        |                      |            |                       |          |                      |         |                |                           |            |                      |            |                       |          |                      |

### GENERAL NOTES

Begin Drilling ..... **07-23-2013** ..... Complete Drilling ..... **07-24-2013** .....  
 Drilling Contractor ..... **Wang Testing Services** ..... Drill Rig .....  
 Driller ..... **R&N** ..... Logger ..... **A. Happel** ..... Checked by ..... **C. Marin** .....  
 Drilling Method ..... **2.25" SSA to 10', mud rotary thereafter, boring** .....  
 ..... **backfilled upon completion** .....

### WATER LEVEL DATA

While Drilling ..... ▽ ..... **Rotary wash** .....  
 At Completion of Drilling ..... ▽ ..... **mud in the borehole** .....  
 Time After Drilling ..... **NA** .....  
 Depth to Water ..... ▽ ..... **NA** .....

The stratification lines represent the approximate boundary between soil types; the actual transition may be gradual.



# BORING LOG 1705-B-11

wangeng@wangeng.com  
 1145 N Main Street  
 Lombard, IL 60148  
 Telephone: 630 953-9928  
 Fax: 630 953-9938

WEI Job No.: 1100-04-01

Client: **AECOM**  
 Project: **Circle Interchange Reconstruction**  
 Location: **Section 17, T39N, R14E of 3rd PM**

Datum: NAVD 88  
 Elevation: 580.50 ft  
 North: 1898132.10 ft  
 East: 1171174.95 ft  
 Station: 1834+90.93  
 Offset: 2.3250 LT

| Profile | Elevation (ft) | SOIL AND ROCK DESCRIPTION   | Depth (ft) | Sample Type recovery | Sample No. | SPT Values (blw/6 in) | Qu (tsf)  | Moisture Content (%) | Profile | Elevation (ft) | SOIL AND ROCK DESCRIPTION | Depth (ft) | Sample Type recovery | Sample No. | SPT Values (blw/6 in) | Qu (tsf)  | Moisture Content (%) |
|---------|----------------|---|------------|----------------------|------------|-----------------------|-----------|----------------------|---------|----------------|---------------------------|------------|----------------------|------------|-----------------------|-----------|----------------------|
|         | 579.8          | 8-inch thick CRUSHED STONE  |            |                      |            |                       |           |                      |         |                |                           |            |                      |            |                       |           |                      |
|         |                | Medium dense, brown SILTY LOAM, trace gravel and pieces of cinders<br>--FILL--        |            |                      | 1          | 4<br>5<br>6           | NP        | 14                   |         |                |                           |            |                      | 9          | 0<br>0<br>0           | 0.49<br>B | 26                   |
|         | 577.5          | Medium stiff to very stiff, brown SILTY CLAY LOAM, trace gravel, pockets of fine sand |            |                      | 2          | 2<br>1<br>1           | 2.50<br>P | 14                   |         |                |                           | 25         |                      | 10         | 0<br>0<br>0           | 0.33<br>B | 28                   |
|         |                |   |            |                      | 3          | 2<br>3<br>3           | 1.07<br>B | 18                   |         |                |                           |            |                      | 11         | 0<br>0<br>2           | 0.16<br>B | 24                   |
|         |                |   |            |                      | 4          | 2<br>1<br>3           | 0.74<br>B | 17                   |         |                |                           | 30         |                      | 12         | 0<br>0<br>1           | 0.33<br>B | 26                   |
|         |                |   |            |                      | 5          | 0<br>2<br>3           | 1.15<br>B | 18                   |         |                |                           |            |                      |            |                       |           |                      |
|         | 567.5          | Very soft to medium stiff, gray and brown CLAY to SILTY CLAY, trace gravel            |            |                      | 6          | 0<br>0<br>0           | 0.74<br>B | 25                   |         |                |                           | 35         |                      | 13         | 0<br>2<br>3           | 0.82<br>B | 27                   |
|         |                |   |            |                      | 7          | 0<br>0<br>1           | 0.74<br>B | 25                   |         |                |                           |            |                      |            |                       |           |                      |
|         |                |   |            |                      | 8          | 0<br>0<br>2           | 0.74<br>B | 22                   |         |                |                           | 40         |                      | 14         | 2<br>2<br>3           | 0.66<br>B | 23                   |

### GENERAL NOTES

Begin Drilling **07-28-2013** Complete Drilling **07-29-2013**  
 Drilling Contractor **Wang Testing Services** Drill Rig **D-50 TMR [78%]**  
 Driller **R&N** Logger **A. Happel** Checked by **C. Marin**  
 Drilling Method **2.25" SSA to 10', mud rotary thereafter, boring backfilled upon completion**

### WATER LEVEL DATA

While Drilling  **Rotary wash**  
 At Completion of Drilling  **mud in the borehole**  
 Time After Drilling **NA**  
 Depth to Water  **NA**

The stratification lines represent the approximate boundary between soil types; the actual transition may be gradual.

WANGENGINC 11000401.GPJ WANGENG.GDT 8/1/17





# BORING LOG 1705-B-11

wangeng@wangeng.com  
 1145 N Main Street  
 Lombard, IL 60148  
 Telephone: 630 953-9928  
 Fax: 630 953-9938

WEI Job No.: 1100-04-01

Client **AECOM**  
 Project **Circle Interchange Reconstruction**  
 Location **Section 17, T39N, R14E of 3rd PM**

Datum: NAVD 88  
 Elevation: 580.50 ft  
 North: 1898132.10 ft  
 East: 1171174.95 ft  
 Station: 1834+90.93  
 Offset: 2.3250 LT

| Profile | Elevation (ft) | SOIL AND ROCK DESCRIPTION   | Depth (ft) | Sample Type recovery | Sample No. | SPT Values (blw/6 in) | Qu (tsf)  | Moisture Content (%) | Profile | Elevation (ft) | SOIL AND ROCK DESCRIPTION                          | Depth (ft) | Sample Type recovery | Sample No. | SPT Values (blw/6 in) | Qu (tsf)  | Moisture Content (%) |
|---------|----------------|---|------------|----------------------|------------|-----------------------|-----------|----------------------|---------|----------------|--|------------|----------------------|------------|-----------------------|-----------|----------------------|
|         | 538.8          | Very stiff to hard, gray CLAY to SILTY CLAY, trace gravel   |            |                      |            |                       |           |                      |         | 518.8          | Dense to very dense, gray SILTY LOAM, trace gravel |            |                      |            |                       |           |                      |
|         |                |   | 45         | X                    | 15         | 5<br>9<br>13          | 4.92<br>B | 16                   |         |                |  | 65         | X                    | 19         | 20<br>27<br>42        | NP        | 13                   |
|         |                | --L <sub>L</sub> (%)=37, P <sub>L</sub> (%)=17--<br>--%Gravel=1.9--<br>--%Sand=11.6--<br>--%Silt=47.1--<br>--%Clay=39.5--<br>--A-6 (17)-- | 50         | X                    | 16         | 7<br>10<br>15         | 4.20<br>B | 16                   |         |                |  | 70         | X                    | 20         | 14<br>20<br>29        | NP        | 15                   |
|         |                |   | 55         | X                    | 17         | 6<br>12<br>18         | 3.77<br>B | 14                   |         |                |  | 75         | X                    | 21         | 29<br>45<br>50/4      | NP        | 10                   |
|         | 523.8          | Medium dense, gray SILT<br>--Moist--  |            |                      |            |                       |           |                      |         | 503.8          | Hard, gray SILTY CLAY LOAM, trace gravel           |            |                      |            |                       |           |                      |
|         |                |   | 60         | X                    | 18         | 8<br>11<br>16         | NP        | 22                   |         |                |  | 80         | X                    | 22         | 12<br>25<br>36        | 6.97<br>B | 11                   |
|         |                |   |            |                      |            |                       |           |                      |         |                | --HARD DRILLING--<br>--Possible Cobbles--          |            |                      |            |                       |           |                      |

### GENERAL NOTES

Begin Drilling **07-28-2013** Complete Drilling **07-29-2013**  
 Drilling Contractor **Wang Testing Services** Drill Rig **D-50 TMR [78%]**  
 Driller **R&N** Logger **A. Happel** Checked by **C. Marin**  
 Drilling Method **2.25" SSA to 10', mud rotary thereafter, boring backfilled upon completion**

### WATER LEVEL DATA

While Drilling  **Rotary wash**  
 At Completion of Drilling  **mud in the borehole**  
 Time After Drilling **NA**  
 Depth to Water  **NA**

The stratification lines represent the approximate boundary between soil types; the actual transition may be gradual.

WANGENGINC 11000401.GPJ WANGENG.GDT 8/1/17



# BORING LOG 1705-B-11

wangeng@wangeng.com  
 1145 N Main Street  
 Lombard, IL 60148  
 Telephone: 630 953-9928  
 Fax: 630 953-9938

WEI Job No.: 1100-04-01

Client **AECOM**  
 Project **Circle Interchange Reconstruction**  
 Location **Section 17, T39N, R14E of 3rd PM**

Datum: NAVD 88  
 Elevation: 580.50 ft  
 North: 1898132.10 ft  
 East: 1171174.95 ft  
 Station: 1834+90.93  
 Offset: 2.3250 LT

| Profile | Elevation (ft) | SOIL AND ROCK DESCRIPTION  | Depth (ft) | Sample Type recovery | Sample No.       | SPT Values (blw/6 in) | Qu (tsf) | Moisture Content (%) | Profile | Elevation (ft) | SOIL AND ROCK DESCRIPTION      | Depth (ft) | Sample Type recovery | Sample No. | SPT Values (blw/6 in) | Qu (tsf) | Moisture Content (%) |
|---------|----------------|--|------------|----------------------|------------------|-----------------------|----------|----------------------|---------|----------------|--------------------------------|------------|----------------------|------------|-----------------------|----------|----------------------|
|         | 498.8          | Very dense, gray SILT, trace gravel  |            |                      |                  |                       |          |                      |         |                |                                |            |                      |            |                       |          |                      |
|         |                | --%Gravel=1.0--<br>--%Sand=1.5--<br>--%Silt=92.3--<br>--%Clay=5.2--<br>--A-4 (0)--   | 85         | 23                   | 26<br>46<br>50/5 | NP                    | 24       |                      |         | 476.5          | Boring terminated at 104.00 ft | 105        |                      |            |                       |          |                      |
|         | 492.5          | Very dense, GRAVEL, trace cobbles  | 90         |                      | 24               | 50/3                  | NA       |                      |         |                |                                |            |                      |            |                       |          |                      |
|         |                | --HARD DRILLING to 94'--<br>--Possible Cobbles--   |            |                      |                  |                       |          |                      |         |                |                                |            |                      |            |                       |          |                      |
|         | 486.5          | Strong, fair rock quality, light gray, fresh, vertical and horizontal joints, joint breaks with little to no infill, horizontal stylolites, slightly vuggy DOLOSTONE | 95         |                      | 25               | 50/3                  | NP       | 15                   |         |                |                                |            |                      |            |                       |          |                      |
|         |                | --Run 1 - RECOVERY=100%--<br>--RQD (top 5ft)=70%--<br>--RQD (10ft)=82%--   |            |                      |                  |                       |          |                      |         |                |                                |            |                      |            |                       |          |                      |
|         |                |  | 100        |                      |                  |                       | NP       |                      |         |                |                                | 120        |                      |            |                       |          |                      |

WANGENGINC 11000401.GPJ WANGENG.GDT 8/1/17

### GENERAL NOTES

### WATER LEVEL DATA

Begin Drilling **07-28-2013** Complete Drilling **07-29-2013**  
 Drilling Contractor **Wang Testing Services** Drill Rig **D-50 TMR [78%]**  
 Driller **R&N** Logger **A. Happel** Checked by **C. Marin**  
 Drilling Method **2.25" SSA to 10', mud rotary thereafter, boring backfilled upon completion**

While Drilling  $\nabla$  **Rotary wash**  
 At Completion of Drilling  $\nabla$  **mud in the borehole**  
 Time After Drilling **NA**  
 Depth to Water  $\nabla$  **NA**

The stratification lines represent the approximate boundary between soil types; the actual transition may be gradual.

RUN #1  
TOP



RUN #1  
BOTTOM

0 3 6 9 12 inches

Boring 1705-B-11  
RUN #1, 94 to 104 FEET  
RECOVERY = 100%  
RQD (top 5 ft.) = 70%  
RQD (10 ft.) = 82%

BEDROCK CORE: CIRCLE INTERCHANGE RECONSTRUCTION,  
RETAINING WALL 47, SN 016-1834, COOK COUNTY

SCALE : GRAPHIC

1705-B-11

DRAWN BY: RKC  
CHECKED BY: NSB



**Wang**  
Engineering

1145 N. Main Street  
Lombard, IL 60148  
www.wangeng.com

FOR AECOM

1100-04-01



# BORING LOG 1705-B-11A

wangeng@wangeng.com  
 1145 N Main Street  
 Lombard, IL 60148  
 Telephone: 630 953-9928  
 Fax: 630 953-9938

WEI Job No.: 1100-04-01

Client: **AECOM**  
 Project: **Circle Interchange Reconstruction**  
 Location: **Section 17, T39N, R14E of 3rd PM**

Datum: NAVD 88  
 Elevation: 586.03 ft  
 North: 1898136.23 ft  
 East: 1171162.02 ft  
 Station: 1835+03.58  
 Offset: 2.6066 RT

| Profile | Elevation (ft) | SOIL AND ROCK DESCRIPTION                            | Depth (ft) | Sample Type recovery | Sample No. | SPT Values (blw/6 in) | Qu (tsf) | Moisture Content (%) | Profile | Elevation (ft) | SOIL AND ROCK DESCRIPTION   | Depth (ft) | Sample Type recovery | Sample No. | SPT Values (blw/6 in) | Qu (tsf) | Moisture Content (%) |
|---------|----------------|--|------------|----------------------|------------|-----------------------|----------|----------------------|---------|----------------|---|------------|----------------------|------------|-----------------------|----------|----------------------|
|         |                | --Drilled without sampling--                         |            |                      |            |                       |          |                      |         |                | --%Clay=34.8--<br>--A-6 (13)--  |            |                      |            |                       |          |                      |
|         |                |  | 5          |                      |            |                       |          |                      |         |                | --L <sub>L</sub> (%)=33, P <sub>L</sub> (%)=17--<br>--%Gravel=2.7--<br>--%Sand=14.4--<br>--%Silt=48.7--<br>--%Clay=34.3--<br>--A-6 (12)-- |            | 3                    |            |                       |          |                      |
|         |                |  | 10         |                      |            |                       |          |                      |         |                | --L <sub>L</sub> (%)=34, P <sub>L</sub> (%)=17--<br>--%Gravel=4.6--<br>--%Sand=13.0--<br>--%Silt=48.4--<br>--%Clay=34.0--<br>--A-6 (13)-- |            | 4                    |            |                       |          |                      |
|         | 573.0          | Hard, gray SILTY CLAY, trace gravel                  | 15         |                      | 1          |                       | 4.50 P   |                      |         |                | --L <sub>L</sub> (%)=37, P <sub>L</sub> (%)=17--<br>--%Gravel=2.6--<br>--%Sand=10.1--<br>--%Silt=48.2--<br>--%Clay=39.1--<br>--A-6 (17)-- |            | 5                    |            |                       |          |                      |
|         | 569.5          | Soft to stiff, gray CLAY to SILTY CLAY, trace gravel | 20         |                      | 2          |                       | 0.88 B   | 23                   |         |                | --L <sub>L</sub> (%)=33, P <sub>L</sub> (%)=16--<br>--%Gravel=4.2--<br>--%Sand=11.8--<br>--%Silt=49.7--<br>--%Clay=34.4--<br>--A-6 (13)-- |            | 6                    |            |                       |          |                      |
|         |                |  | 40         |                      |            |                       |          |                      |         | 546.0          |   |            |                      |            |                       |          |                      |

Boring terminated at 40.00 ft

### GENERAL NOTES

### WATER LEVEL DATA

Begin Drilling **08-04-2013** Complete Drilling **08-05-2013**  
 Drilling Contractor **Wang Testing Services** Drill Rig **D-50 TMR [78%]**  
 Driller **R&K** Logger **A. Tomaras** Checked by **C. Marin**  
 Drilling Method **3.25" HSA, boring backfilled upon completion**

While Drilling  Rotary wash  
 At Completion of Drilling  mud in the borehole  
 Time After Drilling **NA**  
 Depth to Water  **NA**

The stratification lines represent the approximate boundary between soil types; the actual transition may be gradual.

WANGENGINC 11000401.GPJ WANGENG.GDT 8/11/17



# BORING LOG 1714-B-01

wangeng@wangeng.com  
 1145 N Main Street  
 Lombard, IL 60148  
 Telephone: 630 953-9928  
 Fax: 630 953-9938

WEI Job No.: 1100-04-01

Client: **AECOM**  
 Project: **Circle Interchange Reconstruction**  
 Location: **Section 17, T39N, R14E of 3rd PM**

Datum: NAVD 88  
 Elevation: 593.22 ft  
 North: 1898191.77 ft  
 East: 1171304.89 ft  
 Station: 1218+92.09  
 Offset: 41.4568 LT

| Profile | Elevation (ft) | SOIL AND ROCK DESCRIPTION  | Depth (ft) | Sample Type recovery | Sample No. | SPT Values (blw/6 in) | Qu (tsf)    | Moisture Content (%) | Profile | Elevation (ft) | SOIL AND ROCK DESCRIPTION                                   | Depth (ft) | Sample Type recovery | Sample No. | SPT Values (blw/6 in) | Qu (tsf)  | Moisture Content (%) |  |
|---------|----------------|--|------------|----------------------|------------|-----------------------|-------------|----------------------|---------|----------------|---|------------|----------------------|------------|-----------------------|-----------|----------------------|--|
|         | 593.03         | 3-inch thick, brown LOAM<br>--TOPSOIL--<br>Hard, brown CLAY LOAM, trace gravel and brick fragments<br>--FILL-- |            |                      | 1          | 6<br>10<br>9          | 4.50<br>P   | 13                   |         | 572.7          | Soft to medium stiff, gray CLAY to SILTY CLAY, trace gravel |            |                      | 9          | 2<br>3<br>3           | 0.74<br>B | 24                   |  |
|         |                |  | 5          |                      | 2          | 7<br>7<br>7           | 4.25<br>B   | 20                   |         |                |   | 25         |                      | 10         | 2<br>3<br>2           | 0.74<br>B | 25                   |  |
|         | 587.7          | Very stiff to hard, brown and gray SILTY CLAY, trace gravel<br>--FILL--  |            |                      | 3          | 3<br>3<br>4           | 3.25<br>B   | 16                   |         |                |   |            |                      | 11         | 2<br>2<br>2           | 0.66<br>B | 25                   |  |
|         |                |  | 10         |                      | 4          | 6<br>8<br>8           | 6.56<br>B   | 20                   |         |                |   | 30         |                      | 12         | 2<br>2<br>2           | 0.49<br>B | 24                   |  |
|         | 582.7          | Medium stiff to stiff, gray SILTY CLAY, trace gravel   |            |                      | 5          | 2<br>3<br>3           | 1.15<br>B   | 19                   |         |                |   |            |                      |            |                       |           |                      |  |
|         |                |  | 15         |                      | 6          | 2<br>2<br>3           | 0.98<br>B   | 17                   |         |                |   | 35         |                      | 13         | 1<br>2<br>2           | 0.25<br>B | 26                   |  |
|         |                |  |            |                      | 7          | 2<br>2<br>4           | 1.00<br>N/6 | 24                   |         |                |   |            |                      |            |                       |           |                      |  |
|         |                |  | 20         |                      | 8          | 2<br>4<br>4           | 1.48<br>B   | 18                   |         |                |   | 40         |                      | 14         | 1<br>1<br>2           | 0.33<br>B | 26                   |  |

### GENERAL NOTES

Begin Drilling **10-16-2013** Complete Drilling **10-16-2013**  
 Drilling Contractor **Wang Testing Services** Drill Rig **CME-55 TMR [85%]**  
 Driller **R&J** Logger **A. Tomaras** Checked by **C. Marin**  
 Drilling Method **2.25" HSA to 10', mud rotary thereafter, boring backfilled upon completion**

### WATER LEVEL DATA

While Drilling  **Rotary wash**  
 At Completion of Drilling  **mud in the borehole**  
 Time After Drilling **NA**  
 Depth to Water  **NA**

The stratification lines represent the approximate boundary between soil types; the actual transition may be gradual.

WANGENGINC 11000401.GPJ WANGENG.GDT 8/1/17



# BORING LOG 1714-B-01

wangeng@wangeng.com  
 1145 N Main Street  
 Lombard, IL 60148  
 Telephone: 630 953-9928  
 Fax: 630 953-9938

WEI Job No.: 1100-04-01

Client: **AECOM**  
 Project: **Circle Interchange Reconstruction**  
 Location: **Section 17, T39N, R14E of 3rd PM**

Datum: NAVD 88  
 Elevation: 593.22 ft  
 North: 1898191.77 ft  
 East: 1171304.89 ft  
 Station: 1218+92.09  
 Offset: 41.4568 LT

| Profile | Elevation (ft) | SOIL AND ROCK DESCRIPTION  | Depth (ft) | Sample Type recovery | Sample No. | SPT Values (blw/6 in) | Qu (tsf)  | Moisture Content (%) | Profile | Elevation (ft) | SOIL AND ROCK DESCRIPTION                | Depth (ft) | Sample Type recovery | Sample No. | SPT Values (blw/6 in) | Qu (tsf)    | Moisture Content (%) |
|---------|----------------|--|------------|----------------------|------------|-----------------------|-----------|----------------------|---------|----------------|--|------------|----------------------|------------|-----------------------|-------------|----------------------|
|         |                |  | 45         |                      | 15         | 2<br>2<br>2           | 0.25<br>B | 25                   |         |                |  | 65         |                      | 19         | 18<br>20<br>23        | 7.17<br>N/6 |                      |
|         |                |  | 50         |                      | 16         | 2<br>2<br>2           | 0.33<br>B | 27                   |         |                |  | 70         |                      | 20         | 10<br>13<br>19        | 2.54<br>S   | 11                   |
|         | 541.5          | Very stiff to hard, gray SILTY CLAY to SILTY CLAY LOAM, trace gravel | 55         |                      | 17         | 7<br>7<br>12          | 2.95<br>B | 20                   |         |                |  | 75         |                      | 21         | 12<br>17<br>23        | 6.67<br>N/6 |                      |
|         |                |  | 60         |                      | 18         | 16<br>15<br>16        | 5.17<br>B | 12                   |         |                |  | 80         |                      | 22         | 33<br>41<br>40        | 6.69<br>S   | 11                   |
|         |                |  |            |                      |            |                       |           |                      |         | 516.5          | Gray SANDY LOAM<br>--Wet--               |            |                      |            |                       |             |                      |
|         |                |  |            |                      |            |                       |           |                      |         | 514.3          | Hard, gray SILTY CLAY LOAM, trace gravel |            |                      |            |                       |             |                      |

### GENERAL NOTES

### WATER LEVEL DATA

Begin Drilling **10-16-2013** Complete Drilling **10-16-2013**  
 Drilling Contractor **Wang Testing Services** Drill Rig **CME-55 TMR [85%]**  
 Driller **R&J** Logger **A. Tomaras** Checked by **C. Marin**  
 Drilling Method **2.25" HSA to 10', mud rotary thereafter, boring backfilled upon completion**

While Drilling  **Rotary wash**  
 At Completion of Drilling  **mud in the borehole**  
 Time After Drilling **NA**  
 Depth to Water  **NA**

The stratification lines represent the approximate boundary between soil types; the actual transition may be gradual.

WANGENGINC 11000401.GPJ WANGENG.GDT 8/1/17



# BORING LOG 1714-B-01

wangeng@wangeng.com  
 1145 N Main Street  
 Lombard, IL 60148  
 Telephone: 630 953-9928  
 Fax: 630 953-9938

WEI Job No.: 1100-04-01

Client: **AECOM**  
 Project: **Circle Interchange Reconstruction**  
 Location: **Section 17, T39N, R14E of 3rd PM**

Datum: NAVD 88  
 Elevation: 593.22 ft  
 North: 1898191.77 ft  
 East: 1171304.89 ft  
 Station: 1218+92.09  
 Offset: 41.4568 LT

| Profile | Elevation (ft) | SOIL AND ROCK DESCRIPTION                             | Depth (ft) | Sample Type recovery | Sample No. | SPT Values (blw/6 in) | Qu (tsf)  | Moisture Content (%) | Profile | Elevation (ft) | SOIL AND ROCK DESCRIPTION  | Depth (ft) | Sample Type recovery | Sample No. | SPT Values (blw/6 in) | Qu (tsf) | Moisture Content (%) |
|---------|----------------|---|------------|----------------------|------------|-----------------------|-----------|----------------------|---------|----------------|--|------------|----------------------|------------|-----------------------|----------|----------------------|
|         | 506.2          | Very dense, gray SILTY LOAM, trace gravel and cobbles | 85         | X                    | 23         | 16<br>21<br>25        | 7.30<br>S | 13                   |         | 486.5          | Very dense, gray GRAVELLY LOAM, trace pyrite and dolostone fragments | 105        | X                    | 28         | 30<br>45<br>50/3      | NP       | 24                   |
|         |                | --HARD DRILLING--<br>--Possible Cobbles--             |            |                      |            |                       |           |                      |         | 484.5          | --WEATHERED BEDROCK--<br>--ROLLER BIT REFUSAL--                      | 110        | X                    | 29         | 50/2                  | NP       | 12                   |
|         |                | --HARD DRILLING--<br>--Possible Cobbles--             | 90         | X                    | 24         | 50/1                  | NP        | 12                   |         | 482.2          | Boring terminated at 111.00 ft                                       |            |                      |            |                       |          |                      |
|         |                | --HARD DRILLING--<br>--Possible Cobbles--             | 95         | X                    | 26         | 50/5                  | NP        | 11                   |         |                |  | 115        |                      |            |                       |          |                      |
|         | 496.2          | Very dense, gray SILT<br>--Saturated--                | 100        | X                    | 27         | 50/4                  | NP        | 18                   |         |                |  | 120        |                      |            |                       |          |                      |

### GENERAL NOTES

Begin Drilling **10-16-2013** Complete Drilling **10-16-2013**  
 Drilling Contractor **Wang Testing Services** Drill Rig **CME-55 TMR [85%]**  
 Driller **R&J** Logger **A. Tomaras** Checked by **C. Marin**  
 Drilling Method **2.25" HSA to 10', mud rotary thereafter, boring backfilled upon completion**

### WATER LEVEL DATA

While Drilling  **Rotary wash**  
 At Completion of Drilling  **mud in the borehole**  
 Time After Drilling **NA**  
 Depth to Water  **NA**

The stratification lines represent the approximate boundary between soil types; the actual transition may be gradual.

WANGENGINC 11000401.GPJ WANGENG.GDT 8/1/17



# BORING LOG 1714-B-02

wangeng@wangeng.com  
 1145 N Main Street  
 Lombard, IL 60148  
 Telephone: 630 953-9928  
 Fax: 630 953-9938

WEI Job No.: 1100-04-01

Client **AECOM**  
 Project **Circle Interchange Reconstruction**  
 Location **Section 17, T39N, R14E of 3rd PM**

Datum: NAVD 88  
 Elevation: 582.53 ft  
 North: 1898095.52 ft  
 East: 1171244.20 ft  
 Station: 1220+22.80  
 Offset: 32.5079 LT

| Profile | Elevation (ft) | SOIL AND ROCK DESCRIPTION  | Depth (ft) | Sample Type recovery | Sample No. | SPT Values (blw/6 in) | Qu (tsf)    | Moisture Content (%) | Profile | Elevation (ft) | SOIL AND ROCK DESCRIPTION | Depth (ft) | Sample Type recovery | Sample No. | SPT Values (blw/6 in) | Qu (tsf)  | Moisture Content (%) |  |
|---------|----------------|--|------------|----------------------|------------|-----------------------|-------------|----------------------|---------|----------------|---------------------------|------------|----------------------|------------|-----------------------|-----------|----------------------|--|
|         | 582.24         | 24-inch thick ASPHALT<br>--PAVEMENT--  |            |                      |            |                       |             |                      |         |                |                           |            |                      |            |                       |           |                      |  |
|         | 581.5          | 8-inch thick CONCRETE<br>--PAVEMENT--  |            |                      |            |                       |             |                      |         |                |                           |            |                      |            |                       |           |                      |  |
|         | 581.0          | 6-inch thick CRUSHED STONE<br>--BASE COURSE--  |            |                      | 1          | 6<br>5<br>6           | 3.77<br>B   | 16                   |         |                |                           |            |                      | 9          | 0<br>0<br>1           | 0.33<br>B | 25                   |  |
|         |                | Very stiff, brown and gray SILTY CLAY LOAM, trace gravel<br>--FILL--   |            |                      | 2          | 3<br>4<br>5           | 2.62<br>B   | 20                   |         |                |                           |            |                      | 10         | 0<br>0<br>0           | 0.16<br>B | 24                   |  |
|         | 577.0          | Medium stiff to stiff, gray SILTY LOAM, trace gravel<br>--L <sub>L</sub> (%)=24, P <sub>L</sub> (%)=15--<br>--%Gravel=14.0--<br>--%Sand=28.0--<br>--%Silt=45.7--<br>--%Clay=12.4--                                     |            |                      | 3          | 2<br>3<br>4           | 1.64<br>B   | 18                   |         |                |                           |            |                      | 11         | 0<br>0<br>2           | 0.08<br>B | 28                   |  |
|         |                |  |            |                      | 4          | 3<br>4<br>4           | 0.98<br>B   | 19                   |         |                |                           |            |                      | 12         | 0<br>1<br>2           | 0.08<br>B | 26                   |  |
|         | 572.0          | Very soft to medium stiff, gray CLAY to SILTY CLAY, trace to some gravel<br>--L <sub>L</sub> (%)=33, P <sub>L</sub> (%)=18--<br>--%Gravel=10.6--<br>--%Sand=13.5--<br>--%Silt=45.8--<br>--%Clay=30.1--<br>--A-6 (10)-- |            |                      | 5          | 0<br>2<br>2           | 0.57<br>B   | 24                   |         |                |                           |            |                      |            |                       |           |                      |  |
|         |                |  |            |                      | 6          | 1<br>1<br>2           | 0.25<br>B   | 22                   |         |                |                           |            |                      | 13         | 0<br>0<br>2           | 0.25<br>B | 25                   |  |
|         |                |  |            |                      | 7          | 1<br>1<br>2           | < 0.25<br>P | 23                   |         |                |                           |            |                      |            |                       |           |                      |  |
|         |                |  |            |                      | 8          | 1<br>1<br>2           | 0.49<br>B   | 25                   |         |                |                           |            |                      | 14         | 2<br>2<br>3           | 0.33<br>B | 36                   |  |

### GENERAL NOTES

Begin Drilling **10-08-2013** Complete Drilling **10-08-2013**  
 Drilling Contractor **Wang Testing Services** Drill Rig **D-50 TMR [78%]**  
 Driller **R&R** Logger **D. Kolpacki** Checked by **C. Marin**  
 Drilling Method **3.25" HSA to 10', mud rotary thereafter, boring**  
**backfilled upon completion**

### WATER LEVEL DATA

While Drilling  **DRY**  
 At Completion of Drilling  **mud in the borehole**  
 Time After Drilling **NA**  
 Depth to Water  **NA**

The stratification lines represent the approximate boundary between soil types; the actual transition may be gradual.

WANGENGINC 11000401.GPJ WANGENG.GDT 8/1/17





# BORING LOG 1714-B-02

wangeng@wangeng.com  
 1145 N Main Street  
 Lombard, IL 60148  
 Telephone: 630 953-9928  
 Fax: 630 953-9938

WEI Job No.: 1100-04-01

Client **AECOM**  
 Project **Circle Interchange Reconstruction**  
 Location **Section 17, T39N, R14E of 3rd PM**

Datum: NAVD 88  
 Elevation: 582.53 ft  
 North: 1898095.52 ft  
 East: 1171244.20 ft  
 Station: 1220+22.80  
 Offset: 32.5079 LT

| Profile | Elevation (ft) | SOIL AND ROCK DESCRIPTION   | Depth (ft) | Sample Type recovery | Sample No. | SPT Values (blw/6 in) | Qu (tsf)  | Moisture Content (%) | Profile | Elevation (ft) | SOIL AND ROCK DESCRIPTION                        | Depth (ft) | Sample Type recovery | Sample No. | SPT Values (blw/6 in) | Qu (tsf)   | Moisture Content (%) |
|---------|----------------|---|------------|----------------------|------------|-----------------------|-----------|----------------------|---------|----------------|--|------------|----------------------|------------|-----------------------|------------|----------------------|
|         |                |   |            |                      |            |                       |           |                      |         |                |  |            |                      |            |                       |            |                      |
|         |                |   |            |                      |            |                       |           |                      |         |                | --%Silt=47.7--<br>--%Clay=38.2--<br>--A-6 (15)-- |            |                      |            |                       |            |                      |
|         | 520.8          |   |            |                      |            |                       |           |                      |         |                | Medium dense, gray SILT                          |            |                      |            |                       |            |                      |
|         |                | --L <sub>L</sub> (%)=33, P <sub>L</sub> (%)=17--<br>--%Gravel=8.5--<br>--%Sand=12.3--<br>--%Silt=46.1--<br>--%Clay=33.1--<br>--A-6 (11)-- | 45         | X                    | 15         | 2<br>4<br>6           | 0.98<br>B | 22                   |         |                |  | 65         | X                    | 19         | 8<br>7<br>6           | NP         | 22                   |
|         | 535.8          | Very stiff, gray SILTY CLAY, trace gravel   |            | X                    | 16         | 5<br>8<br>12          | 3.94<br>B | 15                   |         |                |  | 70         | X                    | 20         | 13<br>21<br>33        | 10.25<br>B | 16                   |
|         |                |   | 50         | X                    | 16         | 5<br>8<br>12          | 3.94<br>B | 15                   |         |                |  |            | X                    | 20         | 13<br>21<br>33        | 10.25<br>B | 16                   |
|         | 530.8          | Very stiff, gray CLAY   |            | X                    | 17         | 4<br>9<br>14          | 2.95<br>B | 21                   |         |                |  | 75         | X                    | 21         | 11<br>17<br>50        | NP         | 16                   |
|         |                |   | 55         | X                    | 17         | 4<br>9<br>14          | 2.95<br>B | 21                   |         |                |  |            | X                    | 21         | 11<br>17<br>50        | NP         | 16                   |
|         |                |   |            | X                    | 18         | 6<br>8<br>12          | 2.46<br>B | 24                   |         |                |  | 80         | X                    | 22         | 54/6                  | NP         | 9                    |
|         |                | --L <sub>L</sub> (%)=35, P <sub>L</sub> (%)=17--<br>--%Gravel=2.9--<br>--%Sand=11.2--   | 60         | X                    | 18         | 6<br>8<br>12          | 2.46<br>B | 24                   |         |                |  |            | X                    | 22         | 54/6                  | NP         | 9                    |

## GENERAL NOTES

Begin Drilling **10-08-2013** Complete Drilling **10-08-2013**  
 Drilling Contractor **Wang Testing Services** Drill Rig **D-50 TMR [78%]**  
 Driller **R&R** Logger **D. Kolpacki** Checked by **C. Marin**  
 Drilling Method **3.25" HSA to 10', mud rotary thereafter, boring backfilled upon completion**

## WATER LEVEL DATA

While Drilling  $\nabla$  **DRY**  
 At Completion of Drilling  $\nabla$  **mud in the borehole**  
 Time After Drilling **NA**  
 Depth to Water  $\nabla$  **NA**

The stratification lines represent the approximate boundary between soil types; the actual transition may be gradual.

WANGENGINC 11000401.GPJ WANGENG.GDT 8/1/17



# BORING LOG 1714-B-02

wangeng@wangeng.com  
 1145 N Main Street  
 Lombard, IL 60148  
 Telephone: 630 953-9928  
 Fax: 630 953-9938

WEI Job No.: 1100-04-01

Client: **AECOM**  
 Project: **Circle Interchange Reconstruction**  
 Location: **Section 17, T39N, R14E of 3rd PM**

Datum: NAVD 88  
 Elevation: 582.53 ft  
 North: 1898095.52 ft  
 East: 1171244.20 ft  
 Station: 1220+22.80  
 Offset: 32.5079 LT

| Profile | Elevation (ft) | SOIL AND ROCK DESCRIPTION   | Depth (ft) | Sample Type recovery | Sample No. | SPT Values (blw/6 in) | Qu (tsf) | Moisture Content (%) | Profile | Elevation (ft) | SOIL AND ROCK DESCRIPTION  | Depth (ft) | Sample Type recovery | Sample No. | SPT Values (blw/6 in) | Qu (tsf) | Moisture Content (%) |  |
|---------|----------------|---|------------|----------------------|------------|-----------------------|----------|----------------------|---------|----------------|--|------------|----------------------|------------|-----------------------|----------|----------------------|--|
|         |                |   |            |                      |            |                       |          |                      |         |                | joints with less than 0.2 inch or no infilling, vuggy and cherty, with stylolitic surfaces.<br><br>--Run 1 - RECOVERY= 93%--<br>--RQD= 86%-- |            |                      |            |                       |          |                      |  |
|         |                |   | 85         |                      | 23         | 69/6                  | NP       | 14                   |         |                |  | 105        |                      | 1          |                       |          |                      |  |
|         |                | --%Gravel=1.9--<br>--%Sand=6.8--<br>--%Silt=83.8--<br>--%Clay=7.4--<br>--A-4 (0)--  |            |                      | 24         |                       |          |                      |         | 474.5          | Boring terminated at 108.00 ft   |            |                      |            |                       |          |                      |  |
|         |                |   | 90         |                      |            | 31<br>45<br>36        | NP       | 18                   |         |                |  | 110        |                      |            |                       |          |                      |  |
|         |                |   |            |                      | 25         | 50/5                  | NP       | 14                   |         |                |  | 115        |                      |            |                       |          |                      |  |
|         | 486.5          | --HARD DRILLING--<br>--WEATHERED BEDROCK--  |            |                      |            |                       |          |                      |         |                |  |            |                      |            |                       |          |                      |  |
|         | 484.5          | Strong, white and light gray, rock quality, horizontally bedded DOLOSTONE, beds up to 18 inch, joint spacing up to 18 inch, |            |                      |            |                       |          |                      |         |                |  |            |                      |            |                       |          |                      |  |
|         |                |   | 100        |                      |            |                       |          |                      |         |                |  | 120        |                      |            |                       |          |                      |  |

### GENERAL NOTES

### WATER LEVEL DATA

Begin Drilling **10-08-2013** Complete Drilling **10-08-2013**  
 Drilling Contractor **Wang Testing Services** Drill Rig **D-50 TMR [78%]**  
 Driller **R&R** Logger **D. Kolpacki** Checked by **C. Marin**  
 Drilling Method **3.25" HSA to 10', mud rotary thereafter, boring backfilled upon completion**

While Drilling  **DRY**  
 At Completion of Drilling  **mud in the borehole**  
 Time After Drilling **NA**  
 Depth to Water  **NA**

The stratification lines represent the approximate boundary between soil types; the actual transition may be gradual.

WANGENGINC 11000401.GPJ WANGENG.GDT 8/1/17

RUN #1  
TOP



RUN #1  
BOTTOM

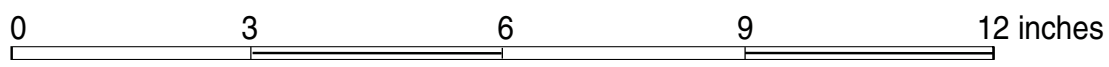

Boring 1714-B-02  
RUN #1, 98 to 108 FEET  
RECOVERY = 93%  
RQD = 86%

|   |           |   |
|---|-----------|---|
| BEDROCK CORE: CIRCLE INTERCHANGE RECONSTRUCTION,<br>RETAINING WALL 47, SN 016-1834, COOK COUNTY |           |   |
| SCALE : GRAPHIC   | 1714-B-02 | DRAWN BY: RKC<br>CHECKED BY: NSB                            |
|            |           | 1145 N. Main Street<br>Lombard, IL 60148<br>www.wangeng.com |
| FOR AECOM   |           | 1100-04-01  |



# BORING LOG 1715-B-04

wangeng@wangeng.com  
 1145 N Main Street  
 Lombard, IL 60148  
 Telephone: 630 953-9928  
 Fax: 630 953-9938

WEI Job No.: 1100-04-01

Client: **AECOM**  
 Project: **Circle Interchange Reconstruction**  
 Location: **Section 17, T39N, R14E of 3rd PM**

Datum: NAVD 88  
 Elevation: 589.41 ft  
 North: 1898275.77 ft  
 East: 1171292.09 ft  
 Station: 1218+40.95  
 Offset: 27.5424 RT

| Profile | Elevation (ft) | SOIL AND ROCK DESCRIPTION   | Depth (ft) | Sample Type recovery | Sample No. | SPT Values (blw/6 in) | Qu (tsf) | Moisture Content (%) | Profile | Elevation (ft) | SOIL AND ROCK DESCRIPTION | Depth (ft) | Sample Type recovery | Sample No. | SPT Values (blw/6 in) | Qu (tsf) | Moisture Content (%) |
|---------|----------------|---|------------|----------------------|------------|-----------------------|----------|----------------------|---------|----------------|---------------------------|------------|----------------------|------------|-----------------------|----------|----------------------|
|         | 589.23         | 3-inch thick, black SILTY LOAM<br>--TOPSOIL--<br>Stiff to very stiff, brown and gray<br>SILTY CLAY LOAM, trace gravel<br>--FILL-- |            |                      | 1          | 50/5                  | 2.50 P   | 14                   |         |                |                           |            |                      |            |                       |          |                      |
|         |                |   | 5          |                      | 2          | 2 3 2                 | 1.15 B   | 18                   |         |                |                           | 25         |                      | 9          | 2 2 3                 | 0.49 B   | 21                   |
|         |                |   |            |                      | 3          | 4 5 7                 | 2.13 B   | 15                   |         |                |                           |            |                      | 10         | 1 2 3                 | 0.49 B   | 24                   |
|         | 581.4          | Soft to medium stiff, gray CLAY to SILTY CLAY, trace gravel   |            |                      | 4          | 1 2 3                 | 0.57 B   | 24                   |         |                |                           |            |                      | 11         | 1 2 2                 | 0.49 B   | 25                   |
|         |                |   | 10         |                      | 5          | 0 0 2                 | 0.16 B   | 24                   |         |                |                           | 30         |                      | 12         | 1 1 2                 | 0.33 B   | 26                   |
|         |                |   |            |                      | 6          | 1 2 2                 | 0.33 B   | 21                   |         |                |                           |            |                      | 13         | 0 1 2                 | 0.25 B   | 26                   |
|         |                |   | 15         |                      | 7          | 1 2 3                 | 0.41 B   | 20                   |         |                |                           | 35         |                      | 14         | 1 2 3                 | 0.74 B   | 24                   |
|         |                |   |            |                      | 8          | 1 2 3                 | 0.49 B   | 23                   |         |                |                           | 40         |                      |            |                       |          |                      |

### GENERAL NOTES

Begin Drilling **03-17-2014** Complete Drilling **03-18-2014**  
 Drilling Contractor **Wang Testing Services** Drill Rig **CME-55 TMR [85%]**  
 Driller **R&N** Logger **F. Bozga** Checked by **C. Marin**  
 Drilling Method **2.25" SSA to 10', mud rotary thereafter, boring backfilled upon completion**

### WATER LEVEL DATA

While Drilling **Rotary wash**  
 At Completion of Drilling **mud at 8 ft**  
 Time After Drilling **24 hours**  
 Depth to Water **8.00 ft**

The stratification lines represent the approximate boundary between soil types; the actual transition may be gradual.

WANGENGINC 11000401.GPJ WANGENG.GDT 8/1/17



# BORING LOG 1715-B-04

wangeng@wangeng.com  
 1145 N Main Street  
 Lombard, IL 60148  
 Telephone: 630 953-9928  
 Fax: 630 953-9938

WEI Job No.: 1100-04-01

Client: **AECOM**  
 Project: **Circle Interchange Reconstruction**  
 Location: **Section 17, T39N, R14E of 3rd PM**

Datum: NAVD 88  
 Elevation: 589.41 ft  
 North: 1898275.77 ft  
 East: 1171292.09 ft  
 Station: 1218+40.95  
 Offset: 27.5424 RT

| Profile | Elevation (ft) | SOIL AND ROCK DESCRIPTION   | Depth (ft) | Sample Type recovery | Sample No. | SPT Values (blw/6 in) | Qu (tsf)  | Moisture Content (%) | Profile | Elevation (ft) | SOIL AND ROCK DESCRIPTION                                     | Depth (ft) | Sample Type recovery | Sample No. | SPT Values (blw/6 in) | Qu (tsf)   | Moisture Content (%) |    |
|---------|----------------|---|------------|----------------------|------------|-----------------------|-----------|----------------------|---------|----------------|---|------------|----------------------|------------|-----------------------|------------|----------------------|----|
|         |                |   |            |                      |            |                       |           |                      |         |                | --%Silt=49.4--<br>--%Clay=28.0--<br>--A-6 (10)--              |            |                      |            |                       |            |                      |    |
|         |                |   | 45         |                      | 15         | 2<br>2<br>3           | 0.74<br>B | 26                   |         |                |   | 65         |                      | 19         | 4<br>10<br>12         | 4.10<br>B  |                      | 23 |
|         |                |   |            |                      |            |                       |           |                      |         | 522.7          | Medium dense, gray SILT, trace fine sand interbeds<br>--Wet-- |            |                      |            |                       |            |                      |    |
|         |                |   | 50         |                      | 16         | 2<br>3<br>5           | 0.74<br>B | 21                   |         |                |   | 70         |                      | 20         | 6<br>11<br>14         | NP         |                      | 17 |
|         | 537.7          | Very stiff to hard, gray SILTY CLAY to SILTY CLAY LOAM, trace gravel                  |            |                      |            |                       |           |                      |         | 517.7          | Hard, gray SILTY CLAY LOAM to SILTY LOAM, trace gravel        |            |                      |            |                       |            |                      |    |
|         |                |   | 55         |                      | 17         | 4<br>7<br>11          | 3.20<br>B | 15                   |         |                |   | 75         |                      | 21         | 13<br>17<br>30        | 10.25<br>B |                      | 14 |
|         |                | --L <sub>L</sub> (%)=31, P <sub>L</sub> (%)=15--<br>--%Gravel=2.8--<br>--%Sand=19.7-- |            |                      |            |                       |           |                      |         |                |   | 80         |                      | 22         | 19<br>29<br>42        | 8.53<br>B  |                      | 14 |

### GENERAL NOTES

### WATER LEVEL DATA

Begin Drilling **03-17-2014** Complete Drilling **03-18-2014**  
 Drilling Contractor **Wang Testing Services** Drill Rig **CME-55 TMR [85%]**  
 Driller **R&N** Logger **F. Bozga** Checked by **C. Marin**  
 Drilling Method **2.25" SSA to 10', mud rotary thereafter, boring backfilled upon completion**

While Drilling **Rotary wash**  
 At Completion of Drilling **mud at 8 ft**  
 Time After Drilling **24 hours**  
 Depth to Water **8.00 ft**

The stratification lines represent the approximate boundary between soil types; the actual transition may be gradual.

WANGENGINC 11000401.GPJ WANGENG.GDT 8/1/17



# BORING LOG 1715-B-04

wangeng@wangeng.com  
 1145 N Main Street  
 Lombard, IL 60148  
 Telephone: 630 953-9928  
 Fax: 630 953-9938

WEI Job No.: 1100-04-01

Client: **AECOM**  
 Project: **Circle Interchange Reconstruction**  
 Location: **Section 17, T39N, R14E of 3rd PM**

Datum: NAVD 88  
 Elevation: 589.41 ft  
 North: 1898275.77 ft  
 East: 1171292.09 ft  
 Station: 1218+40.95  
 Offset: 27.5424 RT

| Profile | Elevation (ft) | SOIL AND ROCK DESCRIPTION  | Depth (ft) | Sample Type recovery | Sample No. | SPT Values (blw/6 in) | Qu (tsf)  | Moisture Content (%) | Profile | Elevation (ft) | SOIL AND ROCK DESCRIPTION   | Depth (ft) | Sample Type recovery | Sample No. | SPT Values (blw/6 in) | Qu (tsf) | Moisture Content (%) |
|---------|----------------|--|------------|----------------------|------------|-----------------------|-----------|----------------------|---------|----------------|---|------------|----------------------|------------|-----------------------|----------|----------------------|
|         | 507.7          | Dense to very dense, gray SILT, trace gravel   |            |                      |            |                       |           |                      |         | 487.7          | Very dense, gray GRAVELLY SANDY LOAM                                      |            |                      |            |                       |          |                      |
|         |                | --L <sub>L</sub> (%)=NP, P <sub>L</sub> (%)=NP--<br>--%Gravel=1.1--<br>--%Sand=7.3--<br>--%Silt=83.5--<br>--%Clay=8.2--<br>--A-4 (0)-- | 85         | X                    | 23         | 17<br>22<br>26        | NP        | 18                   |         |                | --MOIST--   | 105        | X                    | 27         | 30<br>50/4            | NP       | 12                   |
|         |                | --HARD DRILLING--<br>--Possible Cobbles--  |            |                      |            |                       |           |                      |         | 480.9          | --HARD DRILLING--<br>--Possible Cobbles--                                 |            |                      |            |                       |          |                      |
|         |                |  | 90         | X                    | 24         | 50/5                  | NP        | 12                   |         | 479.4          | --DIFFICULT DRILLING--<br>--WEATHERED BEDROCK--<br>--ROLLER BIT REFUSAL-- |            |                      | 28         | 50/1                  | NA       |                      |
|         |                |  |            |                      |            |                       |           |                      |         |                | Boring terminated at 110.00 ft  |            |                      |            |                       |          |                      |
|         | 498.2          | Hard, gray SILTY CLAY, trace gravel  |            |                      |            |                       |           |                      |         |                |   |            |                      |            |                       |          |                      |
|         |                |  | 95         | X                    | 25         | 28<br>50/5            | 5.41<br>B | 18                   |         |                |   | 115        |                      |            |                       |          |                      |
|         | 492.7          | Very dense, gray SILT  |            |                      |            |                       |           |                      |         |                |   |            |                      |            |                       |          |                      |
|         |                | --MOIST--  |            |                      |            |                       |           |                      |         |                |   |            |                      |            |                       |          |                      |
|         |                |  | 100        | X                    | 26         | 18<br>33<br>42        | NP        | 22                   |         |                |   | 120        |                      |            |                       |          |                      |

### GENERAL NOTES

### WATER LEVEL DATA

Begin Drilling **03-17-2014** Complete Drilling **03-18-2014**  
 Drilling Contractor **Wang Testing Services** Drill Rig **CME-55 TMR [85%]**  
 Driller **R&N** Logger **F. Bozga** Checked by **C. Marin**  
 Drilling Method **2.25" SSA to 10', mud rotary thereafter, boring backfilled upon completion**

While Drilling **Rotary wash**  
 At Completion of Drilling **mud at 8 ft**  
 Time After Drilling **24 hours**  
 Depth to Water **8.00 ft**

The stratification lines represent the approximate boundary between soil types; the actual transition may be gradual.

WANGENGINC 11000401.GPJ WANGENG.GDT 8/1/17



# BORING LOG 2081-B-03

wangeng@wangeng.com  
 1145 N Main Street  
 Lombard, IL 60148  
 Telephone: 630 953-9928  
 Fax: 630 953-9938

WEI Job No.: 1100-04-01

Client **AECOM**  
 Project **Circle Interchange Reconstruction**  
 Location **Section 17, T39N, R14E of 3rd PM**

Datum: NAVD 88  
 Elevation: 581.38 ft  
 North: 1898040.36 ft  
 East: 1171151.03 ft  
 Station: 1220+89.44  
 Offset: 51.7421 RT

| Profile | Elevation (ft) | SOIL AND ROCK DESCRIPTION                             | Depth (ft) | Sample Type recovery | Sample No. | SPT Values (blw/6 in) | Qu (tsf)  | Moisture Content (%) | Profile | Elevation (ft) | SOIL AND ROCK DESCRIPTION                    | Depth (ft) | Sample Type recovery | Sample No. | SPT Values (blw/6 in) | Qu (tsf)  | Moisture Content (%) |
|---------|----------------|---|------------|----------------------|------------|-----------------------|-----------|----------------------|---------|----------------|--|------------|----------------------|------------|-----------------------|-----------|----------------------|
|         | 581.14         | 14-inch thick ASPHALT<br>--PAVEMENT--                 |            |                      |            |                       |           |                      |         |                |  |            |                      |            |                       |           |                      |
|         | 580.11         | 11-inch thick CONCRETE<br>--PAVEMENT--                |            |                      |            |                       |           |                      |         |                |  |            |                      |            |                       |           |                      |
|         |                | Loose to medium dense, gray CRUSHED STONE<br>--FILL-- |            |                      | 1          | 2<br>3<br>5           | NP        | 14                   |         |                |  |            |                      | 9          | 0<br>0<br>1           | 0.33<br>B | 25                   |
|         |                |   |            |                      | 2          | 7<br>16<br>12         | NP        | 5                    |         |                |  | 25         |                      | 10         | 0<br>1<br>2           | 0.33<br>B | 27                   |
|         | 575.9          | Medium stiff to stiff, gray SILTY CLAY, trace gravel  |            |                      | 3          | 5<br>8<br>8           | 1.97<br>B | 19                   |         |                |  |            |                      | 11         | 0<br>0<br>0           | 0.25<br>B | 24                   |
|         |                |   |            |                      | 4          | 2<br>2<br>3           | 1.15<br>B | 19                   |         |                |  | 30         |                      | 12         | 0<br>1<br>2           | 0.49<br>B | 26                   |
|         |                |   |            |                      | 5          | 2<br>3<br>3           | 0.82<br>B | 23                   |         |                |  |            |                      |            |                       |           |                      |
|         | 568.4          | Soft to medium stiff, gray CLAY                       |            |                      | 6          | 2<br>3<br>3           | 0.57<br>B | 25                   |         |                |  | 35         |                      | 13         | 0<br>1<br>2           | 0.41<br>B | 29                   |
|         |                |   |            |                      | 7          | 0<br>2<br>2           | 0.57<br>B | 20                   |         | 544.6          | Stiff to hard, gray SILTY CLAY, trace gravel |            |                      |            |                       |           |                      |
|         |                |   |            |                      | 8          | 0<br>2<br>3           | 0.57<br>B | 26                   |         |                |  | 40         |                      | 14         | 1<br>4<br>4           | 1.23<br>B | 23                   |

### GENERAL NOTES

### WATER LEVEL DATA

Begin Drilling **03-28-2013** Complete Drilling **03-29-2013**  
 Drilling Contractor **Wang Testing Services** Drill Rig **B-57 TMR [100%]**  
 Driller **P&N** Logger **D. Wind** Checked by **C. Marin**  
 Drilling Method **3.25" HSA to 8.5', mud rotary thereafter, boring backfilled upon completion**

While Drilling  **Rotary wash**  
 At Completion of Drilling  **mud in the borehole**  
 Time After Drilling **NA**  
 Depth to Water  **NA**

The stratification lines represent the approximate boundary between soil types; the actual transition may be gradual.

WANGENGINC 11000401.GPJ WANGENG.GDT 8/1/17



# BORING LOG 2081-B-03

wangeng@wangeng.com  
 1145 N Main Street  
 Lombard, IL 60148  
 Telephone: 630 953-9928  
 Fax: 630 953-9938

WEI Job No.: 1100-04-01

Client: **AECOM**  
 Project: **Circle Interchange Reconstruction**  
 Location: **Section 17, T39N, R14E of 3rd PM**

Datum: NAVD 88  
 Elevation: 581.38 ft  
 North: 1898040.36 ft  
 East: 1171151.03 ft  
 Station: 1220+89.44  
 Offset: 51.7421 RT

| Profile | Elevation (ft) | SOIL AND ROCK DESCRIPTION            | Depth (ft) | Sample Type recovery | Sample No. | SPT Values (blw/6 in) | Qu (tsf)  | Moisture Content (%) | Profile | Elevation (ft) | SOIL AND ROCK DESCRIPTION                              | Depth (ft) | Sample Type recovery | Sample No. | SPT Values (blw/6 in) | Qu (tsf)  | Moisture Content (%) |
|---------|----------------|--------------------------------------|------------|----------------------|------------|-----------------------|-----------|----------------------|---------|----------------|--|------------|----------------------|------------|-----------------------|-----------|----------------------|
|         | 524.6          | Medium dense, gray SILT              |            |                      |            |                       |           |                      |         | 519.6          | Hard, gray SILTY CLAY LOAM to SILTY LOAM, trace gravel |            |                      |            |                       |           |                      |
|         |                |                                      | 45         |                      | 15         | 7<br>8<br>12          | 5.99<br>B | 13                   |         |                |  | 65         |                      | 19         | 18<br>24<br>32        | 7.95<br>S | 12                   |
|         |                |                                      | 50         |                      | 16         | 5<br>5<br>10          | 3.28<br>B | 21                   |         |                |  | 70         |                      | 20         | 16<br>32<br>50        | 9.84<br>S | 12                   |
|         |                |                                      | 55         |                      | 17         | 4<br>9<br>13          | 4.51<br>B | 18                   |         |                |  | 75         |                      | 21         | 35<br>50/6            | 6.23<br>S | 10                   |
|         | 504.6          | Very dense, gray GRAVELLY SANDY LOAM |            |                      |            |                       |           |                      |         | 504.6          |  |            |                      |            |                       |           |                      |
|         |                |                                      | 60         |                      | 18         | 4<br>7<br>9           | NP        | 17                   |         |                |  | 80         |                      | 22         | 50/6                  | NP        | 12                   |

### GENERAL NOTES

### WATER LEVEL DATA

Begin Drilling **03-28-2013** Complete Drilling **03-29-2013**  
 Drilling Contractor **Wang Testing Services** Drill Rig **B-57 TMR [100%]**  
 Driller **P&N** Logger **D. Wind** Checked by **C. Marin**  
 Drilling Method **3.25" HSA to 8.5', mud rotary thereafter, boring backfilled upon completion**

While Drilling  **Rotary wash**  
 At Completion of Drilling  **mud in the borehole**  
 Time After Drilling **NA**  
 Depth to Water  **NA**

The stratification lines represent the approximate boundary between soil types; the actual transition may be gradual.

WANGENGINC 11000401.GPJ WANGENG.GDT 8/1/17





# BORING LOG 2081-B-03

wangeng@wangeng.com  
 1145 N Main Street  
 Lombard, IL 60148  
 Telephone: 630 953-9928  
 Fax: 630 953-9938

WEI Job No.: 1100-04-01

Client: **AECOM**  
 Project: **Circle Interchange Reconstruction**  
 Location: **Section 17, T39N, R14E of 3rd PM**

Datum: NAVD 88  
 Elevation: 581.38 ft  
 North: 1898040.36 ft  
 East: 1171151.03 ft  
 Station: 1220+89.44  
 Offset: 51.7421 RT

| Profile | Elevation (ft) | SOIL AND ROCK DESCRIPTION   | Depth (ft) | Sample Type recovery | Sample No. | SPT Values (blw/6 in) | Qu (tsf) | Moisture Content (%) | Profile | Elevation (ft) | SOIL AND ROCK DESCRIPTION      | Depth (ft) | Sample Type recovery | Sample No. | SPT Values (blw/6 in) | Qu (tsf) | Moisture Content (%) |  |
|---------|----------------|---|------------|----------------------|------------|-----------------------|----------|----------------------|---------|----------------|--------------------------------|------------|----------------------|------------|-----------------------|----------|----------------------|--|
|         | 499.6          | Very dense, gray SILT<br>--MOIST--  | 85         |                      | 23         | 39<br>49<br>50        | NP       | 20                   |         | 479.4          | Groundwater condition =10      |            |                      |            |                       |          |                      |  |
|         | 494.6          | Very dense, gray GRAVELLY SANDY LOAM  | 90         |                      | 24         | 50/6                  | NP       | 11                   |         |                | Boring terminated at 102.00 ft |            |                      |            |                       |          |                      |  |
|         | 489.4          | Strong, very poor rock quality<br>92'-94', light gray, highly fractured, slightly vuggy DOLOSTONE<br><br>Run 1 = 92' to 102'<br>--RECOVERY=100% <sub>95</sub><br>--RQD=72%<br><br>-Strong, good rock quality<br>94'-102', light gray, fresh, slightly fractured, joint breaks with little to no infill, slightly vuggy DOLOSTONE<br><br>ROCK MASS RATING:<br>Strength of rock material = 12<br>Drill core quality RQD = 13<br>Spacing of joints = 10<br>Condition of joints =12 | 100        |                      | 1          |                       |          |                      |         |                |                                |            |                      |            |                       |          |                      |  |

WANGENGINC 11000401.GPJ WANGENG.GDT 8/1/17

### GENERAL NOTES

Begin Drilling **03-28-2013** Complete Drilling **03-29-2013**  
 Drilling Contractor **Wang Testing Services** Drill Rig **B-57 TMR [100%]**  
 Driller **P&N** Logger **D. Wind** Checked by **C. Marin**  
 Drilling Method **3.25" HSA to 8.5', mud rotary thereafter, boring backfilled upon completion**

### WATER LEVEL DATA

While Drilling  **Rotary wash**  
 At Completion of Drilling  **mud in the borehole**  
 Time After Drilling **NA**  
 Depth to Water  **NA**

The stratification lines represent the approximate boundary between soil types; the actual transition may be gradual.



RUN #1  
TOP

RUN #1  
BOTTOM

0 3 6 9 12 inches

Boring 2081-B-03  
 RUN #1, 92 to 102 FEET  
 RECOVERY = 100%  
 RQD = 72%

|   |           |   |
|---|-----------|---|
| BEDROCK CORE: CIRCLE INTERCHANGE RECONSTRUCTION,<br>RETAINING WALL 47, SN 016-1834, COOK COUNTY |           |   |
| SCALE : GRAPHIC   | 2081-B-03 | DRAWN BY: RKC<br>CHECKED BY: NSB                            |
|            |           | 1145 N. Main Street<br>Lombard, IL 60148<br>www.wangeng.com |
| FOR AECOM   |           | 1100-04-01  |



wangeng@wangeng.com  
 1145 N Main Street  
 Lombard, IL 60148  
 Telephone: 630 953-9928  
 Fax: 630 953-9938

# BORING LOG VST-06

WEI Job No.: 1100-04-01

Client: **AECOM**  
 Project: **Circle Interchange Reconstruction**  
 Location: **Section 17, T39N, R14E of 3rd PM**

Datum: NAVD 88  
 Elevation: 585.69 ft  
 North: 1898109.29 ft  
 East: 1171902.18 ft  
 Station: 1211+74.65  
 Offset: 35.3599 LT

| Profile | Elevation (ft) | SOIL AND ROCK DESCRIPTION   | Depth (ft) | Sample Type recovery | Sample No. | SPT Values (blw/6 in) | Qu (tsf)  | Moisture Content (%) | Profile | Elevation (ft) | SOIL AND ROCK DESCRIPTION   | Depth (ft) | Sample Type recovery | Sample No. | SPT Values (blw/6 in) | Qu (tsf) | Moisture Content (%) |
|---------|----------------|---|------------|----------------------|------------|-----------------------|-----------|----------------------|---------|----------------|---|------------|----------------------|------------|-----------------------|----------|----------------------|
|         | 580.2          | Hard, brown SILTY CLAY LOAM, trace gravel<br>--FILL--   | 5          |                      | 1          | 7<br>6<br>6           | 4.50<br>P | 16                   |         |                | --In-Situ Vane Shear, 20.5 feet--<br>--S <sub>u undis</sub> = 775.4 psf--<br>--S <sub>u remold</sub> = 360.4 psf--<br>--Sensitivity = 2.2-- | 5          |                      | 5          |                       |          |                      |
|         | 576.7          | Soft, gray SILTY CLAY LOAM  | 25         |                      | 2          | 1<br>2<br>3           | 0.41<br>B | 23                   |         |                | --In-Situ Vane Shear, 23.0 feet--<br>--S <sub>u undis</sub> = 600.6 psf--<br>--S <sub>u remold</sub> = 305.8 psf--<br>--Sensitivity = 2.0-- | 6          |                      | 6          |                       |          |                      |
|         |                |   | 30         |                      |            |                       |           |                      |         |                | --In-Situ Vane Shear, 25.5 feet--<br>--S <sub>u undis</sub> = 578.8 psf--<br>--S <sub>u remold</sub> = 316.7 psf--<br>--Sensitivity = 1.8-- | 7          |                      | 7          |                       |          |                      |
|         |                |   | 10         |                      |            |                       |           |                      |         |                | --In-Situ Vane Shear, 28.0 feet--<br>--S <sub>u undis</sub> = 611.6 psf--<br>--S <sub>u remold</sub> = 338.5 psf--<br>--Sensitivity = 1.8-- | 8          |                      | 8          |                       |          |                      |
|         |                | --In-Situ Vane Shear, 10.5 feet--<br>--S <sub>u undis</sub> = 972.0 psf--<br>--S <sub>u remold</sub> = 611.6 psf--<br>--Sensitivity = 1.6-- | 15         |                      | 1          |                       |           |                      |         |                | --In-Situ Vane Shear, 30.5 feet--<br>--S <sub>u undis</sub> = 786.3 psf--<br>--S <sub>u remold</sub> = 382.2 psf--<br>--Sensitivity = 2.1-- | 9          |                      | 9          |                       |          |                      |
|         |                | --In-Situ Vane Shear, 13.0 feet--<br>--S <sub>u undis</sub> = 982.9 psf--<br>--S <sub>u remold</sub> = 589.7 psf--<br>--Sensitivity = 1.7-- | 35         |                      | 2          |                       |           |                      |         |                | --In-Situ Vane Shear, 33.0 feet--<br>--S <sub>u undis</sub> = 698.9 psf--<br>--S <sub>u remold</sub> = 404.1 psf--<br>--Sensitivity = 1.7-- | 10         |                      | 10         |                       |          |                      |
|         |                | --In-Situ Vane Shear, 15.5 feet--<br>--S <sub>u undis</sub> = 873.7 psf--<br>--S <sub>u remold</sub> = 513.3 psf--<br>--Sensitivity = 1.7-- | 40         |                      | 3          |                       |           |                      |         |                | --In-Situ Vane Shear, 35.5 feet--<br>--S <sub>u undis</sub> = 808.1 psf--<br>--S <sub>u remold</sub> = 502.4 psf--<br>--Sensitivity = 1.6-- | 11         |                      | 11         |                       |          |                      |
|         |                | --In-Situ Vane Shear, 18.0 feet--<br>--S <sub>u undis</sub> = 928.3 psf--<br>--S <sub>u remold</sub> = 360.4 psf--<br>--Sensitivity = 2.6-- |            |                      | 4          |                       |           |                      |         |                | --In-Situ Vane Shear, 38.0 feet--<br>--S <sub>u undis</sub> = 982.9 psf--<br>--S <sub>u remold</sub> = 546.0 psf--<br>--Sensitivity = 1.8-- | 12         |                      | 12         |                       |          |                      |

### GENERAL NOTES

Begin Drilling **12-09-2015** Complete Drilling **12-14-2015**  
 Drilling Contractor **Wang Testing Services** Drill Rig **CME-55 TMR [85%]**  
 Driller **R&N** Logger **F. Bozga** Checked by **A. Kurnia**  
 Drilling Method **2.25" HSA to 10', mud rotary thereafter, boring backfilled upon completion**

### WATER LEVEL DATA

While Drilling  **Rotary wash**  
 At Completion of Drilling  **mud in the borehole**  
 Time After Drilling **NA**  
 Depth to Water  **NA**

The stratification lines represent the approximate boundary between soil types; the actual transition may be gradual.

WANGENGINC 11000401.GPJ WANGENG.GDT 7/25/17



wangeng@wangeng.com  
 1145 N Main Street  
 Lombard, IL 60148  
 Telephone: 630 953-9928  
 Fax: 630 953-9938

# BORING LOG VST-06

WEI Job No.: 1100-04-01

Client: **AECOM**  
 Project: **Circle Interchange Reconstruction**  
 Location: **Section 17, T39N, R14E of 3rd PM**

Datum: NAVD 88  
 Elevation: 585.69 ft  
 North: 1898109.29 ft  
 East: 1171902.18 ft  
 Station: 1211+74.65  
 Offset: 35.3599 LT

| Profile | Elevation (ft) | SOIL AND ROCK DESCRIPTION   | Depth (ft) | Sample Type recovery | Sample No. | SPT Values (blw/6 in) | Qu (tsf) | Moisture Content (%) | Profile | Elevation (ft) | SOIL AND ROCK DESCRIPTION | Depth (ft) | Sample Type recovery | Sample No. | SPT Values (blw/6 in) | Qu (tsf) | Moisture Content (%) |
|---------|----------------|---|------------|----------------------|------------|-----------------------|----------|----------------------|---------|----------------|---------------------------|------------|----------------------|------------|-----------------------|----------|----------------------|
|         |                | --In-Situ Vane Shear, 40.5 feet--<br>-- $S_{u\ undis}$ = 906.4 psf--<br>-- $S_{u\ remold}$ = 524.2 psf--<br>--Sensitivity = 1.7-- |            |                      | 13         | VS                    |          |                      |         |                |                           |            |                      |            |                       |          |                      |
|         | 542.2          | --In-Situ Vane Shear, 43.0 feet--<br>-- $S_{u\ undis}$ = 677.1 psf--<br>-- $S_{u\ remold}$ = 393.1 psf--<br>--Sensitivity = 1.7-- |            |                      | 14         | VS                    |          |                      |         |                |                           |            |                      |            |                       |          |                      |
|         |                | Boring terminated at 43.50 ft   | 45         |                      |            |                       |          |                      |         |                |                           |            |                      |            |                       |          |                      |
|         |                |   | 50         |                      |            |                       |          |                      |         |                |                           |            |                      |            |                       |          |                      |
|         |                |   | 55         |                      |            |                       |          |                      |         |                |                           |            |                      |            |                       |          |                      |
|         |                |   | 60         |                      |            |                       |          |                      |         |                |                           |            |                      |            |                       |          |                      |

### GENERAL NOTES

Begin Drilling **12-09-2015** Complete Drilling **12-14-2015**  
 Drilling Contractor **Wang Testing Services** Drill Rig **CME-55 TMR [85%]**  
 Driller **R&N** Logger **F. Bozga** Checked by **A. Kurnia**  
 Drilling Method **2.25" HSA to 10', mud rotary thereafter, boring backfilled upon completion**

### WATER LEVEL DATA

While Drilling  $\nabla$  **Rotary wash**  
 At Completion of Drilling  $\nabla$  **mud in the borehole**  
 Time After Drilling **NA**  
 Depth to Water  $\nabla$  **NA**

The stratification lines represent the approximate boundary between soil types; the actual transition may be gradual.



wangeng@wangeng.com  
 1145 N Main Street  
 Lombard, IL 60148  
 Telephone: 630 953-9928  
 Fax: 630 953-9938

# BORING LOG 1703-PZ-01

WEI Job No.: 1100-04-01

Client: **AECOM**  
 Project: **Circle Interchange Reconstruction**  
 Location: **Section 17, T39N, R14E of 3rd PM**

Datum: NAVD 88  
 Elevation: 582.49 ft  
 North: 1898127.96 ft  
 East: 1171807.47 ft  
 Station: 1104+74.81  
 Offset: 3.30157 RT

| Profile | Elevation (ft) | SOIL AND ROCK DESCRIPTION    | Depth (ft) | Sample Type recovery | Sample No. | SPT Values (blw/6 in) | Qu (tsf) | Moisture Content (%) | Profile | Elevation (ft) | SOIL AND ROCK DESCRIPTION   | Depth (ft) | Sample Type recovery | Sample No. | SPT Values (blw/6 in) | Qu (tsf) | Moisture Content (%) |  |
|---------|----------------|------------------------------|------------|----------------------|------------|-----------------------|----------|----------------------|---------|----------------|---|------------|----------------------|------------|-----------------------|----------|----------------------|--|
|         |                | --Drilled without sampling-- | 5          |                      |            |                       |          |                      |         |                | Piezometer Data:<br>--Installed in Nov. 12, 2014<br>--Bentonite Seal 70 to 72 feet<br>--Top of Sand Pack at 72 feet<br>--Top of Screen at 75.3 feet<br>--Screen Length 20 feet<br>--Bottom of Screen at 95.3 feet | 25         |                      |            |                       |          |                      |  |
|         |                |                              | 10         |                      |            |                       |          |                      |         |                | --piezometer stabilized water level reading --<br>--reading during well development (11/20/2014) = 32.00 feet bgs--<br>--reading date: 12/05/2014 = 31.10 feet bgs--  | 30         |                      |            |                       |          |                      |  |
|         |                |                              | 15         |                      |            |                       |          |                      |         |                |   | 35         |                      |            |                       |          |                      |  |
|         |                |                              | 20         |                      |            |                       |          |                      |         |                |   | 40         |                      |            |                       |          |                      |  |

### GENERAL NOTES

Begin Drilling **11-10-2014** Complete Drilling **11-12-2014**  
 Drilling Contractor **Wang Testing Services** Drill Rig **B-57 TMR [100%]**  
 Driller **P&P** Logger **S. Woods** Checked by **CLM (-Coord)**  
 Drilling Method **4.25" HSA, monitoring water well**

### WATER LEVEL DATA

While Drilling  $\nabla$  **78 ?**  
 At Completion of Drilling  $\nabla$  **mud in the borehole**  
 Time After Drilling **NA**  
 Depth to Water  $\nabla$  **NA**

The stratification lines represent the approximate boundary between soil types; the actual transition may be gradual.



wangeng@wangeng.com  
 1145 N Main Street  
 Lombard, IL 60148  
 Telephone: 630 953-9928  
 Fax: 630 953-9938

# BORING LOG 1703-PZ-01

WEI Job No.: 1100-04-01

Client: **AECOM**  
 Project: **Circle Interchange Reconstruction**  
 Location: **Section 17, T39N, R14E of 3rd PM**

Datum: NAVD 88  
 Elevation: 582.49 ft  
 North: 1898127.96 ft  
 East: 1171807.47 ft  
 Station: 1104+74.81  
 Offset: 3.30157 RT

| Profile | Elevation (ft) | SOIL AND ROCK DESCRIPTION | Depth (ft) | Sample Type recovery | Sample No. | SPT Values (blw/6 in) | Qu (tsf) | Moisture Content (%) | Profile | Elevation (ft) | SOIL AND ROCK DESCRIPTION | Depth (ft) | Sample Type recovery | Sample No. | SPT Values (blw/6 in) | Qu (tsf) | Moisture Content (%) |
|---------|----------------|---------------------------|------------|----------------------|------------|-----------------------|----------|----------------------|---------|----------------|---------------------------|------------|----------------------|------------|-----------------------|----------|----------------------|
|         |                |                           | 45         |                      |            |                       |          |                      |         |                |                           | 65         |                      |            |                       |          |                      |
|         |                |                           | 50         |                      |            |                       |          |                      |         |                |                           | 70         |                      |            |                       |          |                      |
|         |                |                           | 55         |                      |            |                       |          |                      |         |                |                           | 75         |                      |            |                       |          |                      |
|         |                |                           | 60         |                      |            |                       |          |                      |         |                |                           | 80         |                      |            |                       |          |                      |

Piezometer Data:  
 --Installed in Nov. 12, 2014  
 --Bentonite Seal 70 to 72 feet  
 --Top of Sand Pack at 72 feet  
 --Top of Screen at 75.3 feet  
 --Screen Length 20 feet  
 --Bottom of Screen at 95.3 feet

### GENERAL NOTES

### WATER LEVEL DATA

Begin Drilling **11-10-2014** Complete Drilling **11-12-2014**  
 Drilling Contractor **Wang Testing Services** Drill Rig **B-57 TMR [100%]**  
 Driller **P&P** Logger **S. Woods** Checked by **CLM (-Coord)**  
 Drilling Method **4.25" HSA, monitoring water well**

While Drilling  $\nabla$  **78 ?**  
 At Completion of Drilling  $\nabla$  **mud in the borehole**  
 Time After Drilling **NA**  
 Depth to Water  $\nabla$  **NA**

The stratification lines represent the approximate boundary between soil types; the actual transition may be gradual.



# BORING LOG 1703-PZ-01

wangeng@wangeng.com  
 1145 N Main Street  
 Lombard, IL 60148  
 Telephone: 630 953-9928  
 Fax: 630 953-9938

WEI Job No.: 1100-04-01

Client: **AECOM**  
 Project: **Circle Interchange Reconstruction**  
 Location: **Section 17, T39N, R14E of 3rd PM**

Datum: NAVD 88  
 Elevation: 582.49 ft  
 North: 1898127.96 ft  
 East: 1171807.47 ft  
 Station: 1104+74.81  
 Offset: 3.30157 RT

| Profile                        | Elevation (ft) | SOIL AND ROCK DESCRIPTION                 | Depth (ft) | Sample Type recovery | Sample No. | SPT Values (blw/6 in) | Qu (tsf) | Moisture Content (%) | Profile | Elevation (ft) | SOIL AND ROCK DESCRIPTION | Depth (ft) | Sample Type recovery | Sample No. | SPT Values (blw/6 in) | Qu (tsf) | Moisture Content (%) |
|--------------------------------|----------------|---|------------|----------------------|------------|-----------------------|----------|----------------------|---------|----------------|---------------------------|------------|----------------------|------------|-----------------------|----------|----------------------|
|                                | 482.5          | Very dense, gray SILTY LOAM, trace gravel | 85         |                      |            |                       |          |                      |         |                |                           |            |                      |            |                       |          |                      |
|                                |                | --Dry--                                   | 90         |                      | 1          | 40<br>42<br>18/3      | NP       | 13                   |         |                |                           |            |                      |            |                       |          |                      |
|                                |                |   | 95         |                      | 2          | 10<br>23<br>50/3      | NP       | 20                   |         |                |                           |            |                      |            |                       |          |                      |
|                                |                | --Dolostone fragments--                   |            |                      | 3          | 15<br>30/2            | NP       | 14                   |         |                |                           |            |                      |            |                       |          |                      |
|                                |                |   | 100        |                      |            |                       |          |                      |         |                |                           |            |                      |            |                       |          |                      |
| Boring terminated at 100.00 ft |                |   |            |                      |            |                       |          |                      |         |                |                           |            |                      |            |                       |          |                      |

### GENERAL NOTES

### WATER LEVEL DATA

Begin Drilling **11-10-2014** Complete Drilling **11-12-2014**  
 Drilling Contractor **Wang Testing Services** Drill Rig **B-57 TMR [100%]**  
 Driller **P&P** Logger **S. Woods** Checked by **CLM (-Coord)**  
 Drilling Method **4.25" HSA, monitoring water well**

While Drilling  $\nabla$  **78 ?**  
 At Completion of Drilling  $\nabla$  **mud in the borehole**  
 Time After Drilling **NA**  
 Depth to Water  $\nabla$  **NA**

The stratification lines represent the approximate boundary between soil types; the actual transition may be gradual.

## **APPENDIX B**



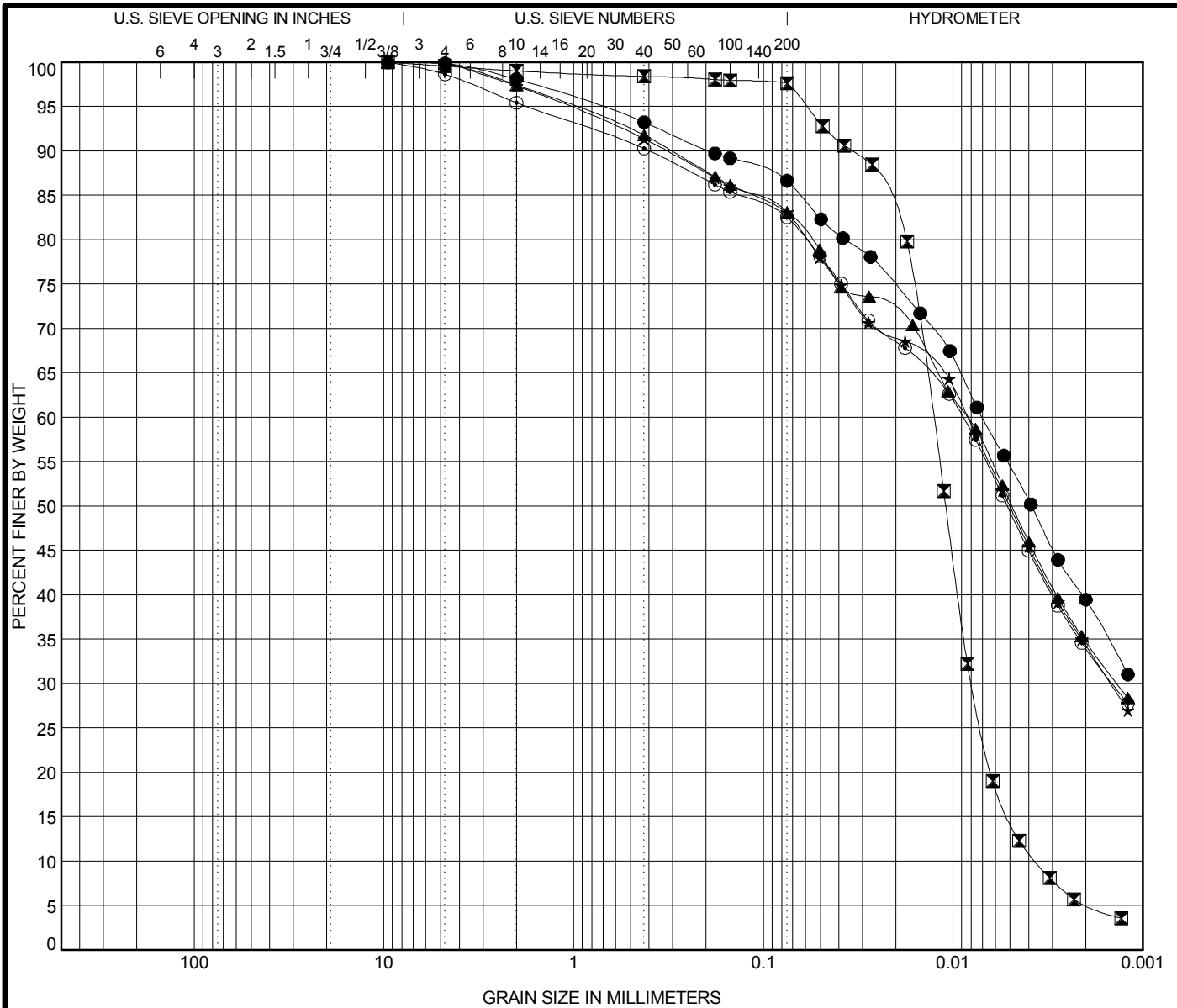

|         |        |        |      |               |
|---------|--------|--------|------|---------------|
| COBBLES | GRAVEL | SAND   |      | SILT AND CLAY |
|         |        | coarse | fine |               |

| Specimen Identification |                      | IDH Classification |       |       |       |         | LL    | PL    | PI    | Cc   | Cu   |
|-------------------------|----------------------|--------------------|-------|-------|-------|---------|-------|-------|-------|------|------|
| ●                       | 1705-B-11#16 48.5 ft | Clay               |       |       |       |         | 37    | 17    | 20    |      |      |
| ☒                       | 1705-B-11#23 83.5 ft | Silt               |       |       |       |         | NP    | NP    | NP    | 1.36 | 3.48 |
| ▲                       | 1705-B-11A#2 18.0 ft | Clay               |       |       |       |         | 34    | 17    | 17    |      |      |
| ★                       | 1705-B-11A#3 23.0 ft | Silty Clay         |       |       |       |         | 33    | 17    | 16    |      |      |
| ◎                       | 1705-B-11A#4 28.0 ft | Silty Clay         |       |       |       |         | 34    | 17    | 17    |      |      |
| Specimen Identification |                      | D100               | D60   | D30   | D10   | %Gravel | %Sand | %Silt | %Clay |      |      |
| ●                       | 1705-B-11#16 48.5 ft | 9.5                | 0.007 |       |       | 1.9     | 11.6  | 47.1  | 39.5  |      |      |
| ☒                       | 1705-B-11#23 83.5 ft | 9.5                | 0.013 | 0.008 | 0.004 | 1.0     | 1.5   | 92.3  | 5.2   |      |      |
| ▲                       | 1705-B-11A#2 18.0 ft | 9.5                | 0.008 | 0.001 |       | 2.6     | 14.5  | 48.2  | 34.8  |      |      |
| ★                       | 1705-B-11A#3 23.0 ft | 4.75               | 0.008 | 0.001 |       | 2.7     | 14.4  | 48.7  | 34.3  |      |      |
| ◎                       | 1705-B-11A#4 28.0 ft | 9.5                | 0.009 | 0.001 |       | 4.6     | 13.0  | 48.4  | 34.0  |      |      |

WEI GRAIN SIZE IDH 11000401.GPJ US\_LAB.GDT 7/25/17



Wang Engineering, Inc.  
 1145 N Main Street  
 Lombard, IL 60148  
 Telephone: 630 953-9928  
 Fax: 630 953-9938

### GRAIN SIZE DISTRIBUTION

Project: Circle Interchange Reconstruction  
 Location: Section 17, T39N, R14E of 3rd PM  
 Number: 1100-04-01

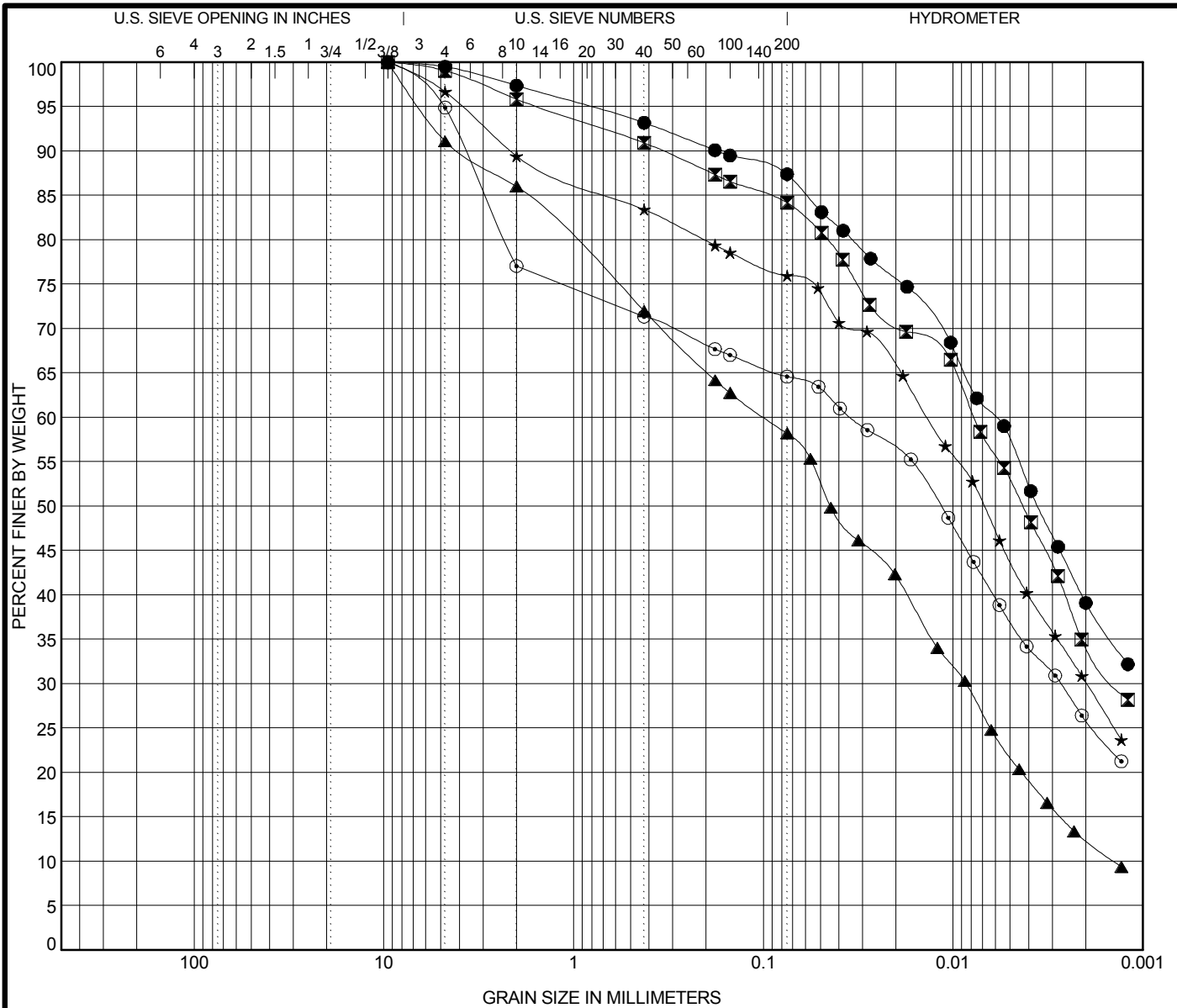

|         |        |        |      |               |
|---------|--------|--------|------|---------------|
| COBBLES | GRAVEL | SAND   |      | SILT AND CLAY |
|         |        | coarse | fine |               |

| Specimen Identification | IDH Classification  | LL | PL | PI | Cc   | Cu    |
|-------------------------|---------------------|----|----|----|------|-------|
| ● 1705-B-11A#5 33.0 ft  | Clay                | 37 | 17 | 20 |      |       |
| ☒ 1705-B-11A#6 38.0 ft  | Silty Clay          | 33 | 16 | 17 |      |       |
| ▲ 1714-B-02#3 6.0 ft    | Silty Loam          | 24 | 15 | 9  | 0.52 | 69.46 |
| ★ 1714-B-02#6 13.5 ft   | Silty Clay          | 33 | 18 | 15 |      |       |
| ⊙ 1714-B-02#12 28.5 ft  | Gravelly Silty Clay | 33 | 17 | 16 |      |       |

| Specimen Identification | D100 | D60   | D30   | D10   | %Gravel | %Sand | %Silt | %Clay |
|-------------------------|------|-------|-------|-------|---------|-------|-------|-------|
| ● 1705-B-11A#5 33.0 ft  | 9.5  | 0.006 |       |       | 2.6     | 10.1  | 48.2  | 39.1  |
| ☒ 1705-B-11A#6 38.0 ft  | 9.5  | 0.008 | 0.001 |       | 4.2     | 11.8  | 49.7  | 34.4  |
| ▲ 1714-B-02#3 6.0 ft    | 9.5  | 0.099 | 0.009 | 0.001 | 14.0    | 28.0  | 45.7  | 12.4  |
| ★ 1714-B-02#6 13.5 ft   | 9.5  | 0.014 | 0.002 |       | 10.6    | 13.5  | 45.8  | 30.1  |
| ⊙ 1714-B-02#12 28.5 ft  | 9.5  | 0.034 | 0.003 |       | 23.0    | 12.5  | 38.7  | 25.9  |



Wang Engineering, Inc.  
 1145 N Main Street  
 Lombard, IL 60148  
 Telephone: 630 953-9928  
 Fax: 630 953-9938

### GRAIN SIZE DISTRIBUTION

Project: Circle Interchange Reconstruction  
 Location: Section 17, T39N, R14E of 3rd PM  
 Number: 1100-04-01

WEI GRAIN SIZE IDH 11000401.GPJ US LAB.GDT 7/25/17

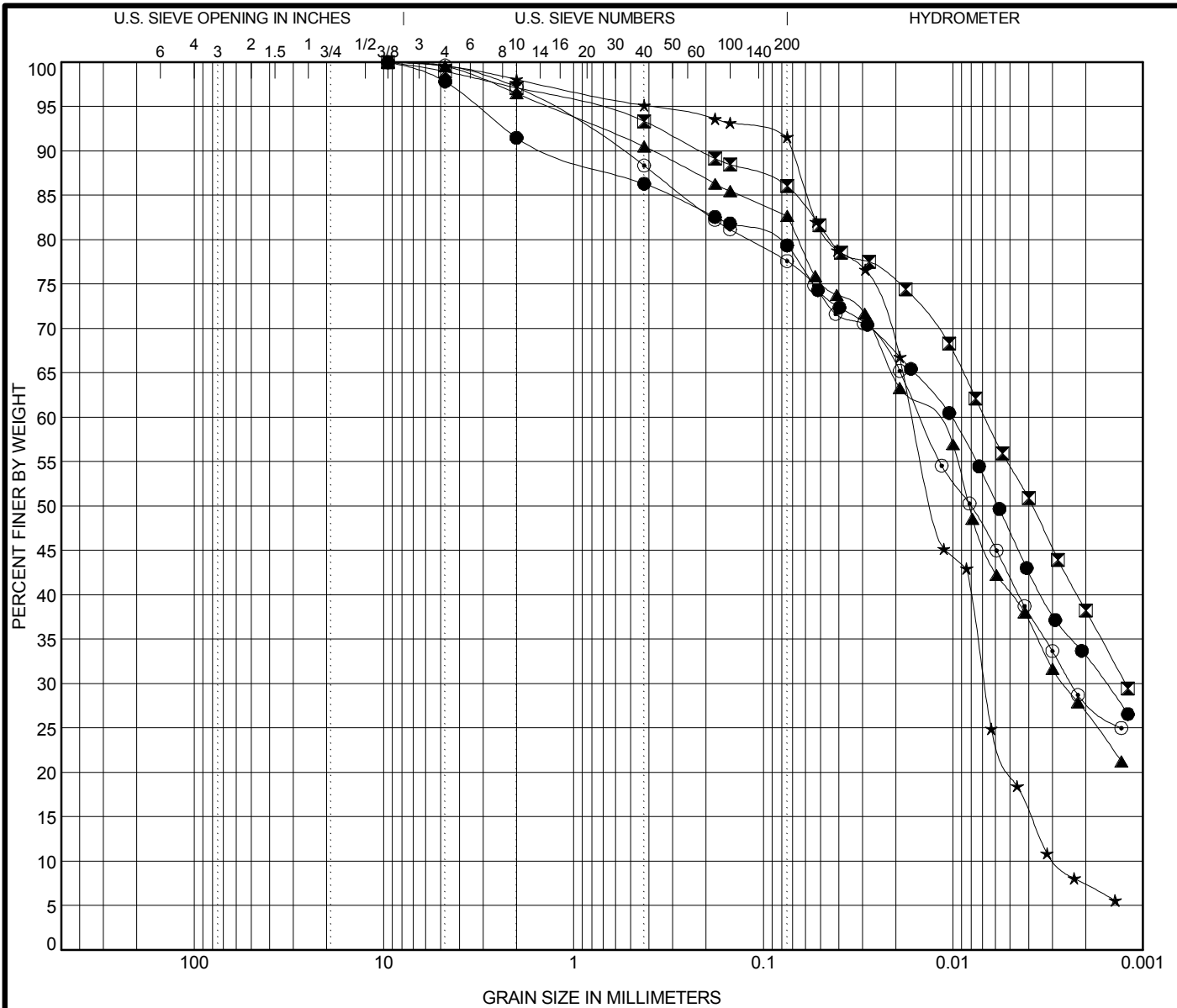

|         |        |        |      |               |
|---------|--------|--------|------|---------------|
| COBBLES | GRAVEL | SAND   |      | SILT AND CLAY |
|         |        | coarse | fine |               |

| Specimen Identification |              |         | IDH Classification |       |       |       |         | LL    | PL    | PI    | Cc   | Cu   |
|-------------------------|--------------|---------|--------------------|-------|-------|-------|---------|-------|-------|-------|------|------|
| ●                       | 1714-B-02#15 | 43.5 ft | Silty Clay         |       |       |       |         | 33    | 17    | 16    |      |      |
| ☒                       | 1714-B-02#18 | 58.5 ft | Clay               |       |       |       |         | 35    | 17    | 18    |      |      |
| ▲                       | 1714-B-02#20 | 68.5 ft | Silty Clay Loam    |       |       |       |         | 31    | 17    | 14    |      |      |
| ★                       | 1714-B-02#24 | 88.5 ft | Silt               |       |       |       |         | NP    | NP    | NP    | 1.01 | 5.59 |
| ⊙                       | 1715-B-04#18 | 58.5 ft | Silty Clay Loam    |       |       |       |         | 31    | 15    | 16    |      |      |
| Specimen Identification |              |         | D100               | D60   | D30   | D10   | %Gravel | %Sand | %Silt | %Clay |      |      |
| ●                       | 1714-B-02#15 | 43.5 ft | 9.5                | 0.01  | 0.002 |       | 8.5     | 12.3  | 46.1  | 33.1  |      |      |
| ☒                       | 1714-B-02#18 | 58.5 ft | 9.5                | 0.007 | 0.001 |       | 2.9     | 11.2  | 47.7  | 38.2  |      |      |
| ▲                       | 1714-B-02#20 | 68.5 ft | 9.5                | 0.014 | 0.003 |       | 3.5     | 14.1  | 55.7  | 26.7  |      |      |
| ★                       | 1714-B-02#24 | 88.5 ft | 9.5                | 0.016 | 0.007 | 0.003 | 1.9     | 6.8   | 83.8  | 7.4   |      |      |
| ⊙                       | 1715-B-04#18 | 58.5 ft | 9.5                | 0.015 | 0.002 |       | 2.8     | 19.7  | 49.4  | 28.0  |      |      |

WEI GRAIN SIZE IDH 11000401.GPJ US LAB.GDT 7/25/17



Wang Engineering, Inc.  
 1145 N Main Street  
 Lombard, IL 60148  
 Telephone: 630 953-9928  
 Fax: 630 953-9938

**GRAIN SIZE DISTRIBUTION**

Project: Circle Interchange Reconstruction  
 Location: Section 17, T39N, R14E of 3rd PM  
 Number: 1100-04-01

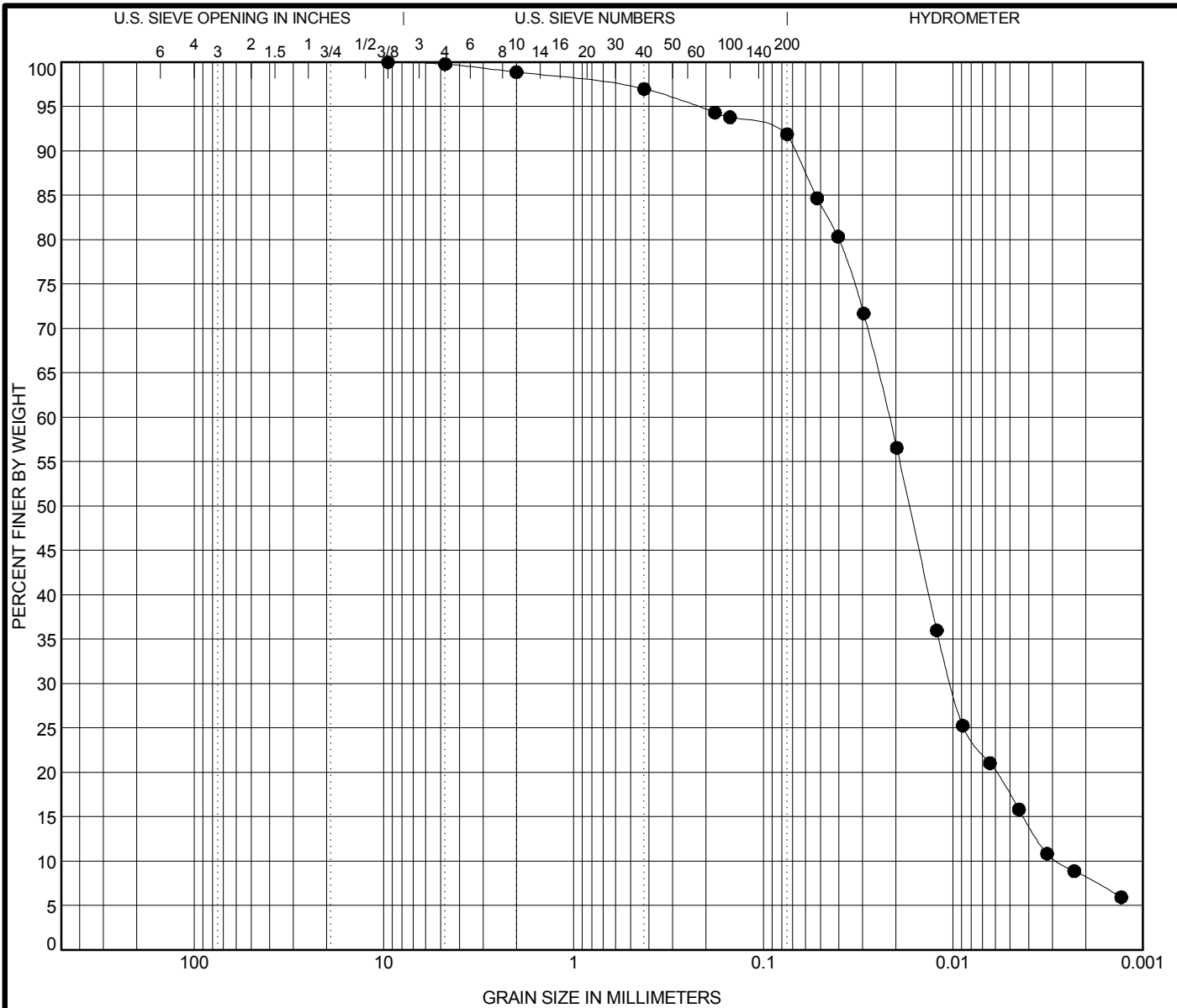

|         |        |        |      |               |
|---------|--------|--------|------|---------------|
| COBBLES | GRAVEL | SAND   |      | SILT AND CLAY |
|         |        | coarse | fine |               |

|                         |                      |                    |  |  |  |  |    |    |    |      |      |
|-------------------------|----------------------|--------------------|--|--|--|--|----|----|----|------|------|
| Specimen Identification |                      | IDH Classification |  |  |  |  | LL | PL | PI | Cc   | Cu   |
| ●                       | 1715-B-04#23 83.5 ft | Silt               |  |  |  |  | NP | NP | NP | 1.74 | 7.82 |

|                         |                      |      |       |      |       |         |       |       |       |
|-------------------------|----------------------|------|-------|------|-------|---------|-------|-------|-------|
| Specimen Identification |                      | D100 | D60   | D30  | D10   | %Gravel | %Sand | %Silt | %Clay |
| ●                       | 1715-B-04#23 83.5 ft | 9.5  | 0.022 | 0.01 | 0.003 | 1.1     | 7.3   | 83.5  | 8.2   |



Wang Engineering, Inc.  
 1145 N Main Street  
 Lombard, IL 60148  
 Telephone: 630 953-9928  
 Fax: 630 953-9938

**GRAIN SIZE DISTRIBUTION**  
 Project: Circle Interchange Reconstruction  
 Location: Section 17, T39N, R14E of 3rd PM  
 Number: 1100-04-01

WEI GRAIN SIZE IDH 11000401.GPJ US LAB.GDT 7/25/17

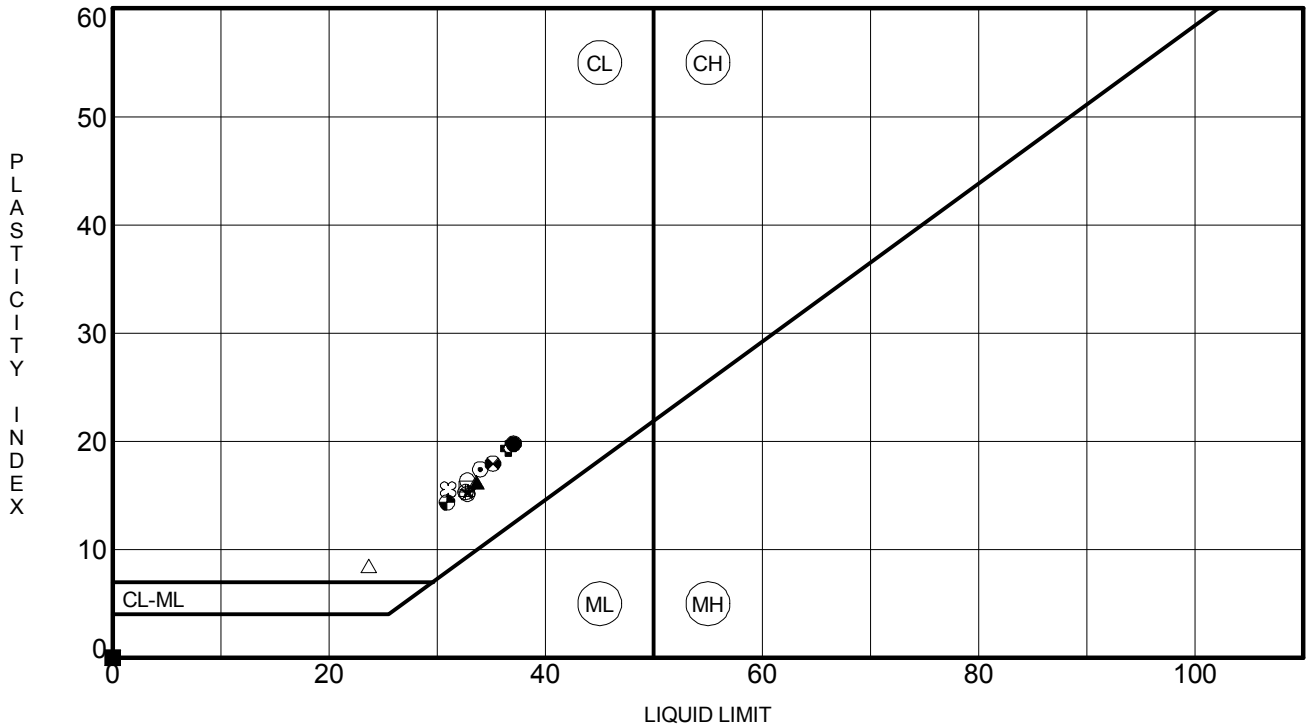

| Specimen Identification | LL      | PL | PI | Fines | IDH Classification |                     |
|-------------------------|---------|----|----|-------|--------------------|---------------------|
| ● 1705-B-11#16          | 48.5 ft | 37 | 17 | 20    | 87                 | Clay                |
| ☒ 1705-B-11#23          | 83.5 ft | NP | NP | NP    | 98                 | Silt                |
| ▲ 1705-B-11A#2          | 18.0 ft | 34 | 17 | 17    | 83                 | Clay                |
| ★ 1705-B-11A#3          | 23.0 ft | 33 | 17 | 16    | 83                 | Silty Clay          |
| ⊙ 1705-B-11A#4          | 28.0 ft | 34 | 17 | 17    | 83                 | Silty Clay          |
| ⊕ 1705-B-11A#5          | 33.0 ft | 37 | 17 | 20    | 87                 | Clay                |
| ○ 1705-B-11A#6          | 38.0 ft | 33 | 16 | 17    | 84                 | Silty Clay          |
| △ 1714-B-02#3           | 6.0 ft  | 24 | 15 | 9     | 58                 | Silty Loam          |
| ⊗ 1714-B-02#6           | 13.5 ft | 33 | 18 | 15    | 76                 | Silty Clay          |
| ⊕ 1714-B-02#12          | 28.5 ft | 33 | 17 | 16    | 65                 | Gravelly Silty Clay |
| □ 1714-B-02#15          | 43.5 ft | 33 | 17 | 16    | 79                 | Silty Clay          |
| ⊕ 1714-B-02#18          | 58.5 ft | 35 | 17 | 18    | 86                 | Clay                |
| ⊕ 1714-B-02#20          | 68.5 ft | 31 | 17 | 14    | 83                 | Silty Clay Loam     |
| ☆ 1714-B-02#24          | 88.5 ft | NP | NP | NP    | 92                 | Silt                |
| ⊗ 1715-B-04#18          | 58.5 ft | 31 | 15 | 16    | 78                 | Silty Clay Loam     |
| ■ 1715-B-04#23          | 83.5 ft | NP | NP | NP    | 92                 | Silt                |
|                         |         |    |    |       |                    |                     |
|                         |         |    |    |       |                    |                     |
|                         |         |    |    |       |                    |                     |
|                         |         |    |    |       |                    |                     |

WEI ATTERBERG LIMITS IDH 11000401.GPJ US LAB.GDT 7/25/17



Wang Engineering, Inc.  
 1145 N Main Street  
 Lombard, IL 60148  
 Telephone: 630 953-9928  
 Fax: 630 953-9938

**ATTERBERG LIMITS' RESULTS**

Project: Circle Interchange Reconstruction  
 Location: Section 17, T39N, R14E of 3rd PM  
 Number: 1100-04-01

**UNCONFINED COMPRESSIVE STRENGTH of COHESIVE SOIL**  
(AASHTO T 208 / ASTM D 2166)

**Project:** Circle Interchange  
**Client:** AECOM  
**WEI Job No.:** 1100-04-01  
**Soil Sample ID:** 1705-B-11A, (18.0-20.0ft)  
**Type/Condition:** ST / Undisturbed  
Liquid Limit (%): 34  
Plastic Limit (%): 17

**Analyst name:** M. de los Reyes  
**Date received:** 8/4/2013  
**Test date:** 8/16/2013  
**Sample description:** Gray Clay

Average initial height  $h_0 = 6.03$  in  
Average initial diameter  $d_0 = 2.84$  in  
Height to diameter ratio = 2.12  
Mass of wet sample and tare  $M_i = 1320.37$  g  
Mass of dry sample and tare  $M_d = 1079.60$  g  
Mass of tare  $M_t = 14.17$  g  
Mass of sample  $M_s = 1306.20$  g  
Estimated specific gravity  $G_s = 2.72$

Sand(%): 14.5  
Silt(%): 48.2  
Clay(%): 34.8  
Initial water content  $w = 22.60\%$   
Initial unit weight  $g = 130.19$  pcf  
Initial dry unit weight  $g_d = 106.19$  pcf  
Initial void ratio  $e_0 = 0.60$   
Initial degree of saturation  $S_r = 100\%$   
Average Rate of Strain = 1%/min  
Unconfined compressive strength  $q_u = 0.88$  tsf  
Shear Strength = 0.44 tsf

| Displacement (in) | Force (lbs) | Strain (%) | Stress (tsf) |
|-------------------|-------------|------------|--------------|
| $\Delta h$        | F           | e          | s            |
| 0.00              | 0.00        | 0.00       | 0.00         |
| 0.03              | 6.22        | 0.50       | 0.07         |
| 0.06              | 12.44       | 0.99       | 0.14         |
| 0.09              | 16.59       | 1.49       | 0.19         |
| 0.12              | 20.74       | 1.99       | 0.23         |
| 0.15              | 26.96       | 2.49       | 0.30         |
| 0.18              | 33.18       | 2.98       | 0.37         |
| 0.21              | 37.33       | 3.48       | 0.41         |
| 0.24              | 41.48       | 3.98       | 0.45         |
| 0.27              | 45.63       | 4.48       | 0.50         |
| 0.30              | 49.78       | 4.97       | 0.54         |
| 0.35              | 56.00       | 5.80       | 0.60         |
| 0.40              | 62.22       | 6.63       | 0.66         |
| 0.45              | 66.37       | 7.46       | 0.70         |
| 0.50              | 72.59       | 8.29       | 0.76         |
| 0.55              | 74.66       | 9.12       | 0.77         |
| 0.60              | 78.81       | 9.95       | 0.81         |
| 0.65              | 78.81       | 10.78      | 0.80         |
| 0.70              | 82.96       | 11.61      | 0.83         |
| 0.75              | 85.03       | 12.44      | 0.85         |
| 0.80              | 88.15       | 13.27      | 0.87         |
| 0.92              | 91.26       | 15.26      | 0.88         |



Prepared by: Jay Date: 8.20.13  
Checked by: AT Date: 8/20/13

**Unconfined Axial Stress v. Axial Strain**  
**1705-B-11A(18.0-20.0ft)**

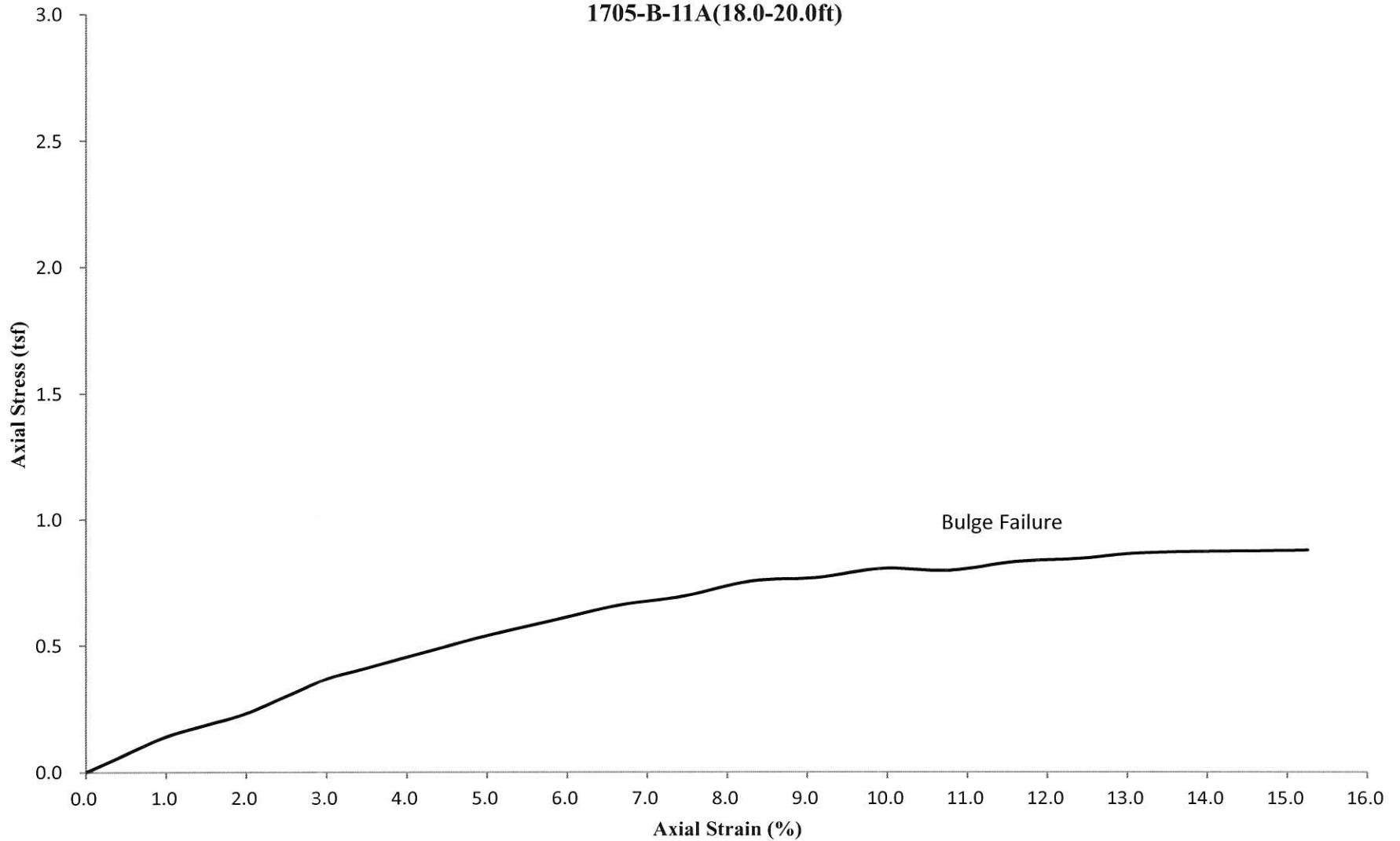

**UNCONFINED COMPRESSIVE STRENGTH of COHESIVE SOIL**  
(AASHTO T 208 / ASTM D 2166)

**Project:** Circle Interchange  
**Client:** AECOM  
**WEI Job No.:** 1100-04-01  
**Soil Sample ID:** 1705-B-11A, (23.0-25.0ft)  
**Type/Condition:** ST / Undisturbed  
Liquid Limit (%): 33  
Plastic Limit (%): 17

**Analyst name:** M. de los Reyes  
**Date received:** 8/4/2013  
**Test date:** 8/21/2013  
**Sample description:** Gray Silty Clay

Average initial height  $h_0 = 6.10$  in  
Average initial diameter  $d_0 = 2.84$  in  
Height to diameter ratio = 2.15  
Mass of wet sample and tare  $M_i = 1321.60$  g  
Mass of dry sample and tare  $M_d = 1065.90$  g  
Mass of tare  $M_t = 14.10$  g  
Mass of sample  $M_s = 1307.50$  g  
Estimated specific gravity  $G_s = 2.78$

Sand(%): 14.4  
Silt(%): 48.7  
Clay(%): 34.3

Initial water content  $w = 24.31\%$   
Initial unit weight  $g = 129.28$  pcf  
Initial dry unit weight  $g_d = 104.00$  pcf  
Initial void ratio  $e_0 = 0.67$   
Initial degree of saturation  $S_r = 100\%$   
Average Rate of Strain = 1%/min  
Unconfined compressive strength  $q_u = 0.62$  tsf  
Shear Strength = 0.31 tsf

| Displacement (in) | Force (lbs) | Strain (%) | Stress (tsf) |
|-------------------|-------------|------------|--------------|
| $\Delta h$        | F           | e          | s            |
| 0.00              | 0.00        | 0.00       | 0.00         |
| 0.03              | 6.22        | 0.49       | 0.07         |
| 0.06              | 10.37       | 0.98       | 0.12         |
| 0.09              | 16.59       | 1.48       | 0.19         |
| 0.12              | 20.74       | 1.97       | 0.23         |
| 0.15              | 24.89       | 2.46       | 0.28         |
| 0.18              | 29.04       | 2.95       | 0.32         |
| 0.21              | 33.18       | 3.45       | 0.36         |
| 0.24              | 39.41       | 3.94       | 0.43         |
| 0.27              | 39.41       | 4.43       | 0.43         |
| 0.30              | 41.48       | 4.92       | 0.45         |
| 0.35              | 45.63       | 5.74       | 0.49         |
| 0.40              | 49.78       | 6.56       | 0.53         |
| 0.45              | 51.85       | 7.38       | 0.55         |
| 0.50              | 56.00       | 8.20       | 0.59         |
| 0.55              | 57.04       | 9.02       | 0.59         |
| 0.60              | 60.15       | 9.84       | 0.62         |
| 0.65              | 60.15       | 10.66      | 0.61         |
| 0.70              | 61.18       | 11.48      | 0.62         |
| 0.75              | 62.22       | 12.31      | 0.62         |
| 0.80              | 62.22       | 13.13      | 0.62         |
| 0.92              | 64.29       | 15.09      | 0.62         |

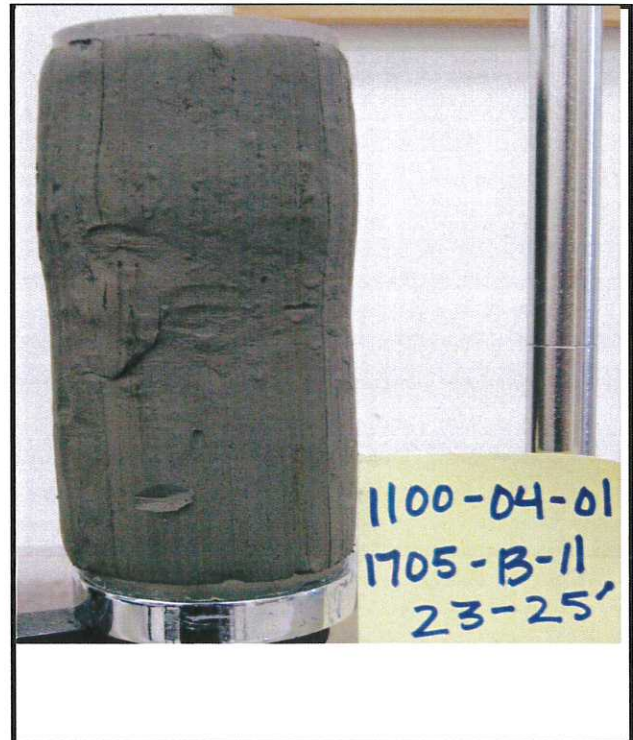

Prepared by: Jay Date: 8.23.13  
Checked by: At Date: 9/23/13



**Unconfined Axial Stress v. Axial Strain**  
**1705-B-11A(23.0-25.0ft)**

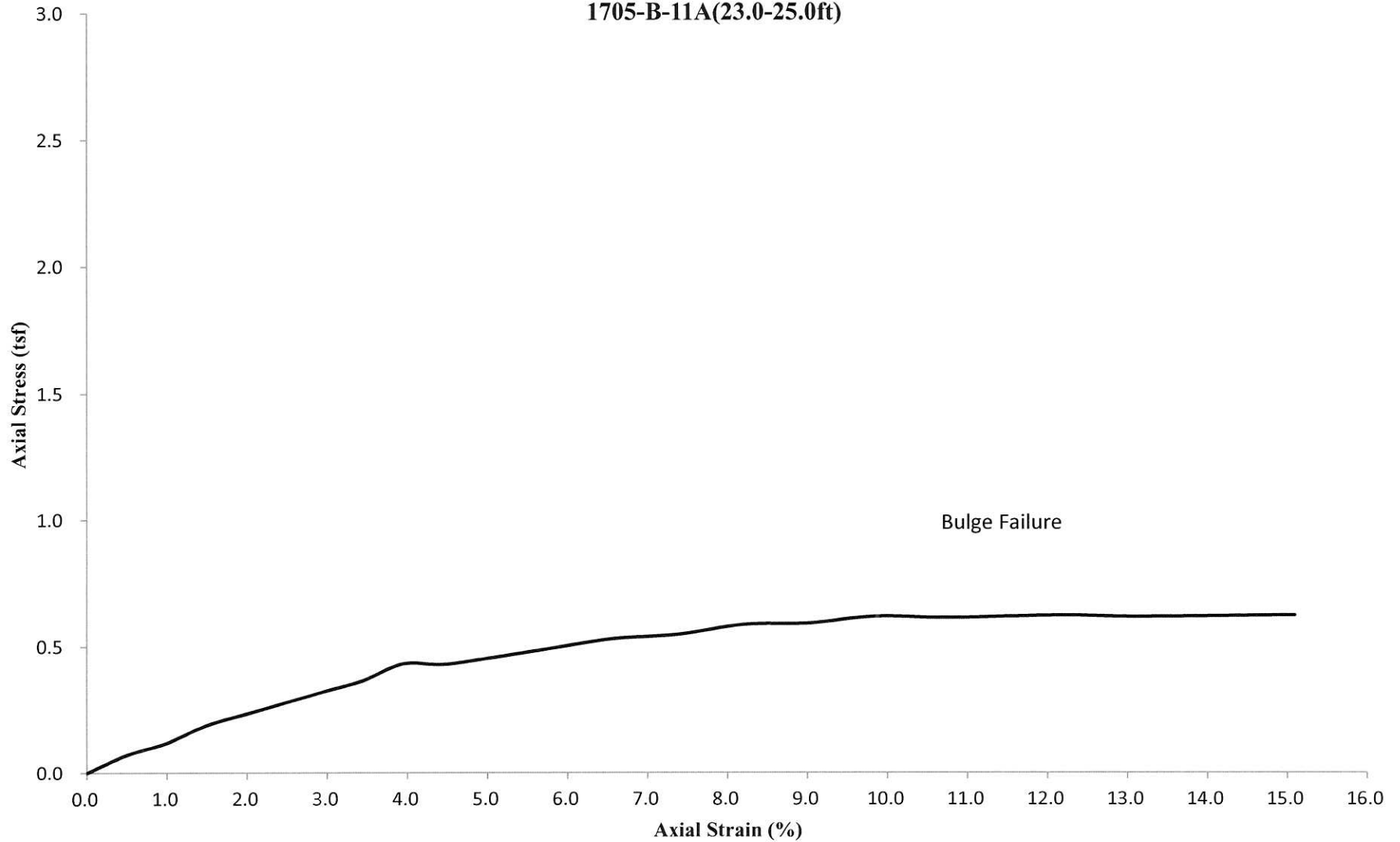

**UNCONFINED COMPRESSIVE STRENGTH of COHESIVE SOIL**  
(AASHTO T 208 / ASTM D 2166)

**Project:** Circle Interchange  
**Client:** AECOM  
**WEI Job No.:** 1100-04-01  
**Soil Sample ID:** 1705-B-11A, (28.0-30.0ft)  
**Type/Condition:** ST / Undisturbed  
Liquid Limit (%): 34  
Plastic Limit (%): 17

**Analyst name:** M. de los Reyes  
**Date received:** 8/4/2013  
**Test date:** 8/21/2013  
**Sample description:** Gray Silty Clay

Average initial height  $h_0 = 5.92$  in  
Average initial diameter  $d_0 = 2.84$  in  
Height to diameter ratio = 2.08  
Mass of wet sample and tare  $M_i = 1434.20$  g  
Mass of dry sample and tare  $M_d = 1196.30$  g  
Mass of tare  $M_r = 153.40$  g  
Mass of sample  $M_s = 1280.80$  g  
Estimated specific gravity  $G_s = 2.75$

Sand(%): 13  
Silt(%): 48.4  
Clay(%): 34  
Initial water content  $w = 22.81\%$   
Initial unit weight  $g = 129.69$  pcf  
Initial dry unit weight  $g_d = 105.60$  pcf  
Initial void ratio  $e_0 = 0.62$   
Initial degree of saturation  $S_r = 100\%$   
Average Rate of Strain = 1%/min  
Unconfined compressive strength  $q_u = 0.52$  tsf  
Shear Strength = 0.26 tsf

| Displacement (in) | Force (lbs) | Strain (%) | Stress (tsf) |
|-------------------|-------------|------------|--------------|
| $\Delta h$        | F           | e          | s            |
| 0.00              | 0.00        | 0.00       | 0.00         |
| 0.03              | 9.33        | 0.51       | 0.11         |
| 0.06              | 13.48       | 1.01       | 0.15         |
| 0.09              | 18.67       | 1.52       | 0.21         |
| 0.12              | 20.74       | 2.03       | 0.23         |
| 0.15              | 24.89       | 2.53       | 0.27         |
| 0.18              | 26.96       | 3.04       | 0.30         |
| 0.21              | 31.11       | 3.55       | 0.34         |
| 0.24              | 33.18       | 4.05       | 0.36         |
| 0.27              | 35.26       | 4.56       | 0.38         |
| 0.30              | 39.41       | 5.06       | 0.42         |
| 0.35              | 41.48       | 5.91       | 0.44         |
| 0.40              | 43.55       | 6.75       | 0.46         |
| 0.45              | 45.63       | 7.60       | 0.48         |
| 0.50              | 45.63       | 8.44       | 0.47         |
| 0.55              | 47.70       | 9.29       | 0.49         |
| 0.60              | 49.78       | 10.13      | 0.51         |
| 0.65              | 49.78       | 10.97      | 0.50         |
| 0.70              | 51.85       | 11.82      | 0.52         |
| 0.75              | 51.85       | 12.66      | 0.51         |
| 0.80              | 51.85       | 13.51      | 0.51         |
| 0.90              | 51.85       | 15.19      | 0.50         |

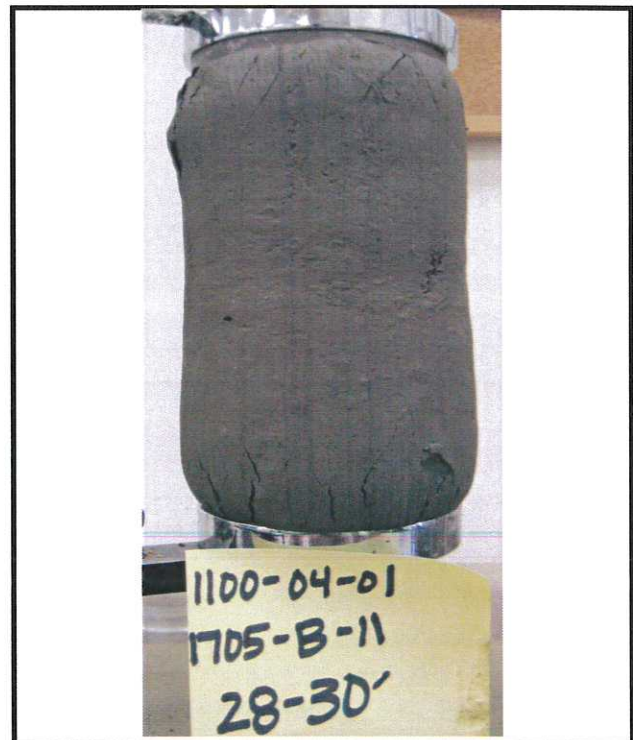

Prepared by: Jay Date: 8.23.13  
Checked by: A.T. Date: 8/29/13

**Unconfined Axial Stress v. Axial Strain**  
**1705-B-11A(28.0-30.0ft)**

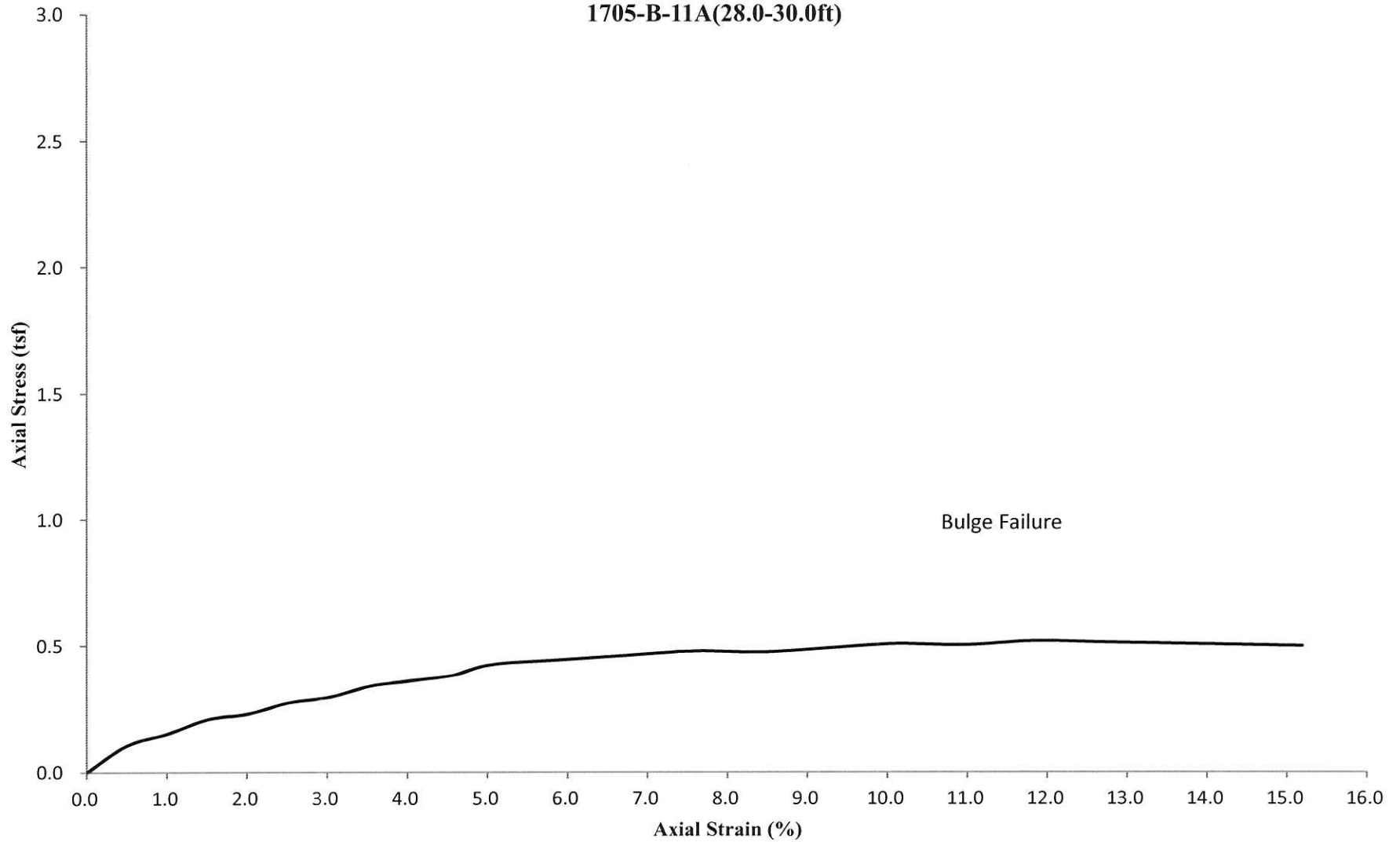

**UNCONFINED COMPRESSIVE STRENGTH of COHESIVE SOIL**  
(AASHTO T 208 / ASTM D 2166)

**Project:** Circle Interchange  
**Client:** AECOM  
**WEI Job No.:** 1100-04-01  
**Soil Sample ID:** 1705-B-11A, (33.0-35.0ft)  
**Type/Condition:** ST / Undisturbed  
Liquid Limit (%): 37  
Plastic Limit (%): 17

**Analyst name:** M. de los Reyes  
**Date received:** 8/4/2013  
**Test date:** 8/21/2013  
**Sample description:** Gray Clay

Average initial height  $h_0 = 5.96$  in  
Average initial diameter  $d_0 = 2.86$  in  
Height to diameter ratio = 2.08  
Mass of wet sample and tare  $M_i = 1455.50$  g  
Mass of dry sample and tare  $M_d = 1202.70$  g  
Mass of tare  $M_r = 163.00$  g  
Mass of sample  $M_s = 1292.50$  g  
Estimated specific gravity  $G_s = 2.76$

Sand(%): 10.1  
Silt(%): 48.2  
Clay(%): 39.1

Initial water content  $w = 24.31\%$   
Initial unit weight  $g = 128.24$  pcf  
Initial dry unit weight  $g_d = 103.16$  pcf  
Initial void ratio  $e_0 = 0.67$   
Initial degree of saturation  $S_r = 100\%$   
Average Rate of Strain = 1%/min  
Unconfined compressive strength  $q_u = 1.12$  tsf  
Shear Strength = 0.56 tsf

| Displacement (in) | Force (lbs) | Strain (%) | Stress (tsf) |
|-------------------|-------------|------------|--------------|
| $\Delta h$        | F           | e          | s            |
| 0.00              | 0.00        | 0.00       | 0.00         |
| 0.03              | 16.59       | 0.50       | 0.18         |
| 0.06              | 26.96       | 1.01       | 0.30         |
| 0.09              | 37.33       | 1.51       | 0.41         |
| 0.12              | 47.70       | 2.01       | 0.52         |
| 0.15              | 58.07       | 2.51       | 0.63         |
| 0.18              | 66.37       | 3.02       | 0.72         |
| 0.21              | 74.66       | 3.52       | 0.81         |
| 0.24              | 78.81       | 4.02       | 0.85         |
| 0.27              | 82.96       | 4.53       | 0.89         |
| 0.30              | 85.03       | 5.03       | 0.90         |
| 0.35              | 91.26       | 5.87       | 0.96         |
| 0.40              | 95.40       | 6.71       | 1.00         |
| 0.45              | 99.55       | 7.54       | 1.03         |
| 0.50              | 101.63      | 8.38       | 1.04         |
| 0.55              | 103.70      | 9.22       | 1.05         |
| 0.60              | 107.85      | 10.06      | 1.08         |
| 0.65              | 107.85      | 10.90      | 1.07         |
| 0.70              | 109.92      | 11.74      | 1.08         |
| 0.75              | 114.07      | 12.57      | 1.12         |
| 0.80              | 114.07      | 13.41      | 1.10         |
| 0.90              | 114.07      | 15.09      | 1.08         |



Prepared by: Jay Date: 8.23.13  
Checked by: At Date: 9/23/13

**Unconfined Axial Stress v. Axial Strain**  
**1705-B-11A(33.0-35.0ft)**

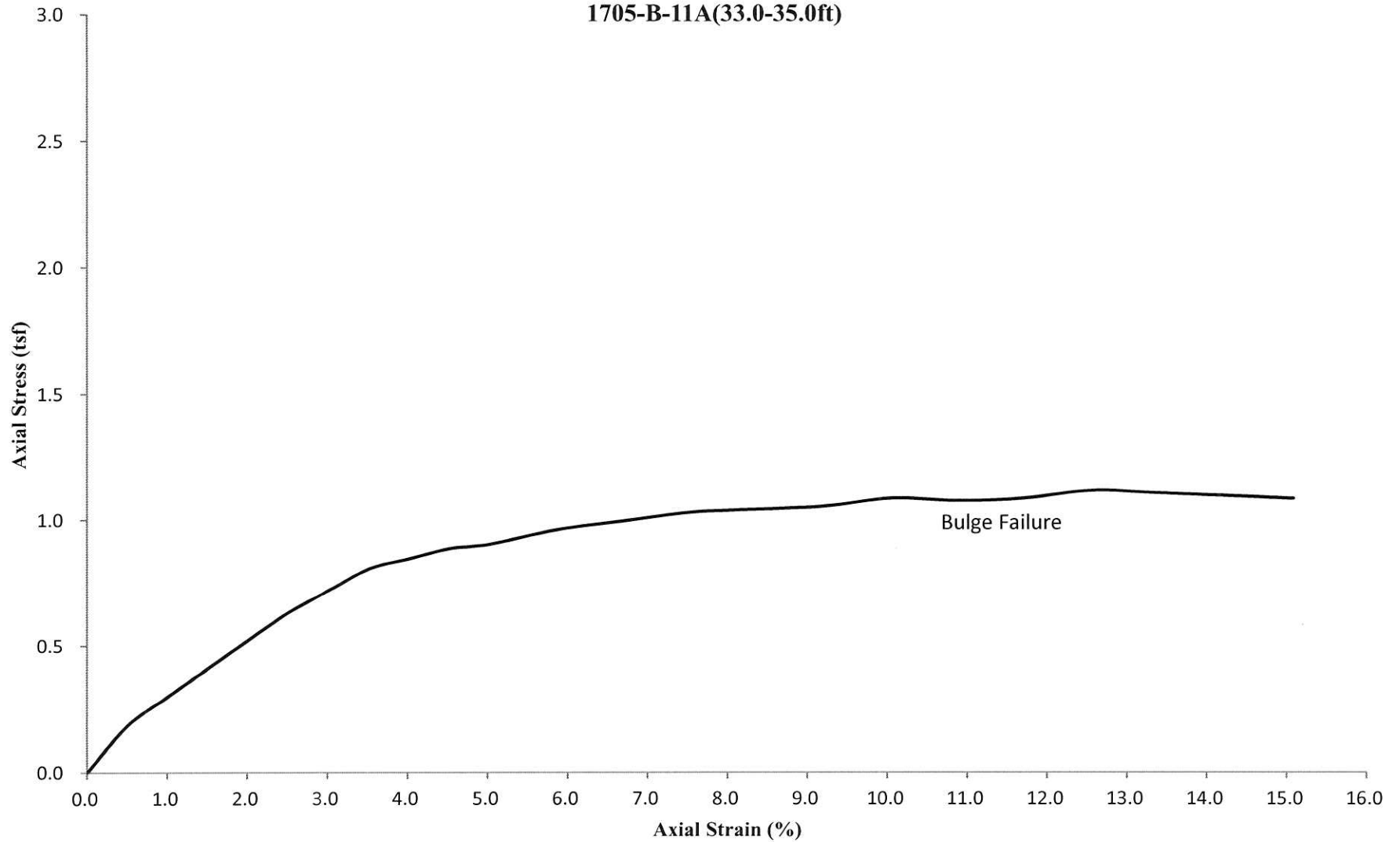

**UNCONFINED COMPRESSIVE STRENGTH of COHESIVE SOIL**  
(AASHTO T 208 / ASTM D 2166)

**Project:** Circle Interchange  
**Client:** AECOM  
**WEI Job No.:** 1100-04-01  
**Soil Sample ID:** 1705-B-11A, (38.0-40.0ft)  
**Type/Condition:** ST / Undisturbed  
Liquid Limit (%): 33  
Plastic Limit (%): 16

**Analyst name:** M. de los Reyes  
**Date received:** 8/4/2013  
**Test date:** 8/19/2013  
**Sample description:** Gray Silty Clay

Average initial height  $h_0 = 6.05$  in  
Average initial diameter  $d_0 = 2.87$  in  
Height to diameter ratio = 2.11  
Mass of wet sample and tare  $M_i = 1349.77$  g  
Mass of dry sample and tare  $M_d = 1114.00$  g  
Mass of tare  $M_t = 13.67$  g  
Mass of sample  $M_s = 1336.10$  g  
Estimated specific gravity  $G_s = 2.75$

Sand(%): 11.8  
Silt(%): 49.7  
Clay(%): 34.4

Initial water content  $w = 21.43\%$   
Initial unit weight  $g = 130.30$  pcf  
Initial dry unit weight  $g_d = 107.31$  pcf  
Initial void ratio  $e_0 = 0.60$   
Initial degree of saturation  $S_r = 98\%$   
Average Rate of Strain = 1%/min  
Unconfined compressive strength  $q_u = 1.38$  tsf  
Shear Strength = 0.69 tsf

| Displacement (in) | Force (lbs) | Strain (%) | Stress (tsf) |
|-------------------|-------------|------------|--------------|
| $\Delta h$        | F           | e          | s            |
| 0.00              | 0.00        | 0.00       | 0.00         |
| 0.03              | 14.52       | 0.50       | 0.16         |
| 0.06              | 18.67       | 0.99       | 0.21         |
| 0.09              | 39.41       | 1.49       | 0.43         |
| 0.12              | 49.78       | 1.98       | 0.54         |
| 0.15              | 62.22       | 2.48       | 0.68         |
| 0.18              | 72.59       | 2.97       | 0.79         |
| 0.21              | 80.89       | 3.47       | 0.87         |
| 0.24              | 87.11       | 3.97       | 0.93         |
| 0.27              | 95.40       | 4.46       | 1.02         |
| 0.30              | 99.55       | 4.96       | 1.06         |
| 0.35              | 105.77      | 5.78       | 1.11         |
| 0.40              | 114.07      | 6.61       | 1.19         |
| 0.45              | 120.29      | 7.44       | 1.24         |
| 0.50              | 124.44      | 8.26       | 1.27         |
| 0.55              | 126.51      | 9.09       | 1.28         |
| 0.60              | 132.74      | 9.92       | 1.33         |
| 0.65              | 132.74      | 10.74      | 1.32         |
| 0.70              | 134.81      | 11.57      | 1.33         |
| 0.75              | 141.03      | 12.39      | 1.38         |
| 0.80              | 141.03      | 13.22      | 1.36         |
| 0.93              | 143.11      | 15.37      | 1.35         |



Prepared by: Jerry  
Checked by: A.F.

Date: 8.21.13  
Date: 8/21/13

**Unconfined Axial Stress v. Axial Strain**  
1705-B-11A(38.0-40.0ft)

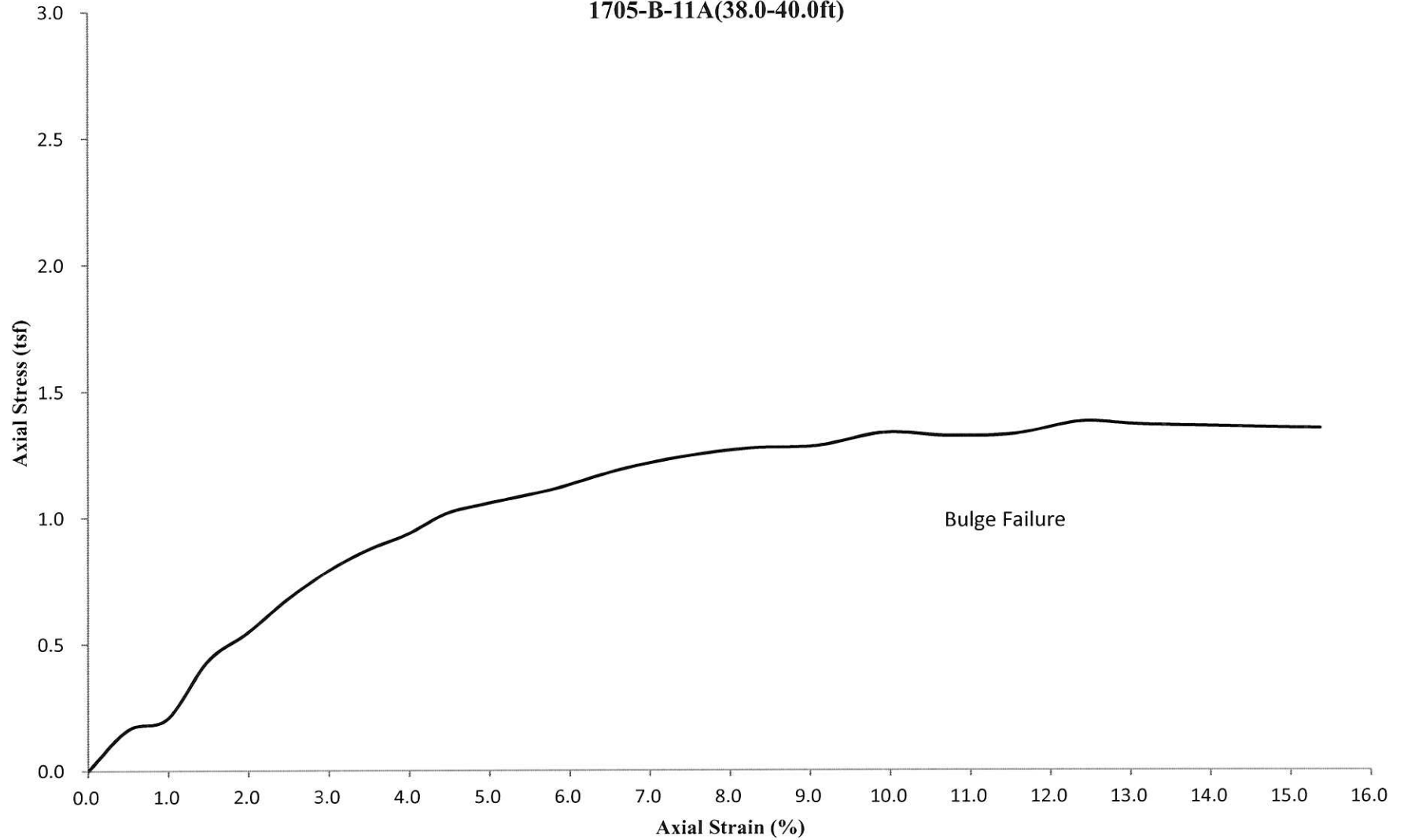



**ONE-DIMENSIONAL CONSOLIDATION TEST**  
**AASHTO T 216 / ASTM D 2435**

**Project:** Circle Interchange  
**Client:** AECOM  
**Soil Sample ID:** Boring 02-RWB-06ST, ST#2, 18' to 20'  
**Sample Description:** Gray LEAN CLAY with trace gravel (CL)

**Tested by:** M. Snider  
**Prepared by:** M. Snider  
**Test date:** 7/30/2013  
**WEI:** 1100-04-01

|                                |            |  |            |
|--------------------------------|------------|--|------------|
| Initial sample height =        | 1.001 in   | Ring diameter =                            | 2.495 in   |
| Initial sample mass =          | 161.06 g   | Ring mass =                                | 109.95 g   |
| Initial water content =        | 26.27%     | Initial sample and ring mass =             | 271.01 g   |
| Initial dry unit weight =      | 99.30 pcf  | Tare mass =                                | 14.22 g    |
| Initial void ratio =           | 0.747      | Final ring and sample mass =               | 263.63 g   |
| Initial degree of saturation = | 97.79%     | Mass of wet sample and tare =              | 167.62 g   |
|                                |            | Mass of dry sample and tare =              | 141.77 g   |
| Final sample mass =            | 153.40 g   | Initial dial reading =                     | 0.01000 in |
| Final dry sample mass =        | 127.55 g   | Final dial reading =                       | 0.13366 in |
| Final water content =          | 20.27%     | LL=  | 35 %       |
| Final dry unit weight =        | 113.30 pcf | PL=  | 17 %       |
| Final void ratio =             | 0.531      | % Sand=                                    | 16.6 %     |
| Final degree of saturation =   | 100.00%    | % Silt=                                    | 51.4 %     |
| Estimated specific gravity =   | 2.78       | % Clay=                                    | 28.8 %     |
|                                |            | <b>In-Situ Vertical Effective Stress =</b> | 2100 psf   |

**Compression and Swelling Indices**

Compression index  $C_c$  = 0.208  
 Field corrected  $C_c$  = 0.240  
 Swelling index  $C_s$  = 0.038

**Preconsolidation pressure,  $s_c$**   
 Casagrande Method = 3292 psf  
**Over-Consolidation Ratio (OCR)** = 1.57

| Load number | Vertical stress<br>psf | Dial reading<br>in | System deflection<br>in | Vertical strain<br>% | Void ratio | $C_v$<br>ft <sup>2</sup> /day | $C_{ae}$<br>% | Elapsed time<br>min |
|-------------|------------------------|--------------------|-------------------------|----------------------|------------|-------------------------------|---------------|---------------------|
| 1           | 100.0                  | 0.01159            | 0.00010                 | 0.17                 | 0.744      | N/A                           | N/A           | 1440                |
| 2           | 200.0                  | 0.01313            | 0.00023                 | 0.34                 | 0.741      | 0.1560                        | 0.08          | 1140                |
| 3           | 500.0                  | 0.01977            | 0.00058                 | 1.03                 | 0.729      | 0.1392                        | 0.10          | 1440                |
| 4           | 1000.0                 | 0.02748            | 0.00090                 | 1.84                 | 0.715      | 0.1326                        | 0.08          | 1380                |
| 5           | 2000.0                 | 0.03883            | 0.00135                 | 3.01                 | 0.694      | 0.1464                        | 0.17          | 1320                |
| 6           | 4000.0                 | 0.06033            | 0.00193                 | 5.22                 | 0.656      | 0.1196                        | 0.33          | 960                 |
| 7           | 8000.0                 | 0.08974            | 0.00253                 | 8.22                 | 0.603      | 0.0960                        | 0.39          | 1440                |
| 8           | 16000.0                | 0.12525            | 0.00324                 | 11.84                | 0.540      | 0.1022                        | 0.43          | 1440                |
| 9           | 32000.0                | 0.15997            | 0.00413                 | 15.39                | 0.478      | 0.1600                        | 0.42          | 1440                |
| 10          | 8000.0                 | 0.15965            | 0.00295                 | 15.24                | 0.481      | N/A                           | N/A           | 480                 |
| 11          | 2000.0                 | 0.14762            | 0.00198                 | 13.95                | 0.503      | N/A                           | N/A           | 2820                |
| 11          | 500.0                  | 0.13528            | 0.00123                 | 12.64                | 0.526      | N/A                           | N/A           | 1440                |

Prepared by: \_\_\_\_\_ Date: \_\_\_\_\_  
 Checked by: \_\_\_\_\_ Date: \_\_\_\_\_





### CONSOLIDATION CURVE

Sample 02-RWB-06ST, ST#2, 18' to 20'

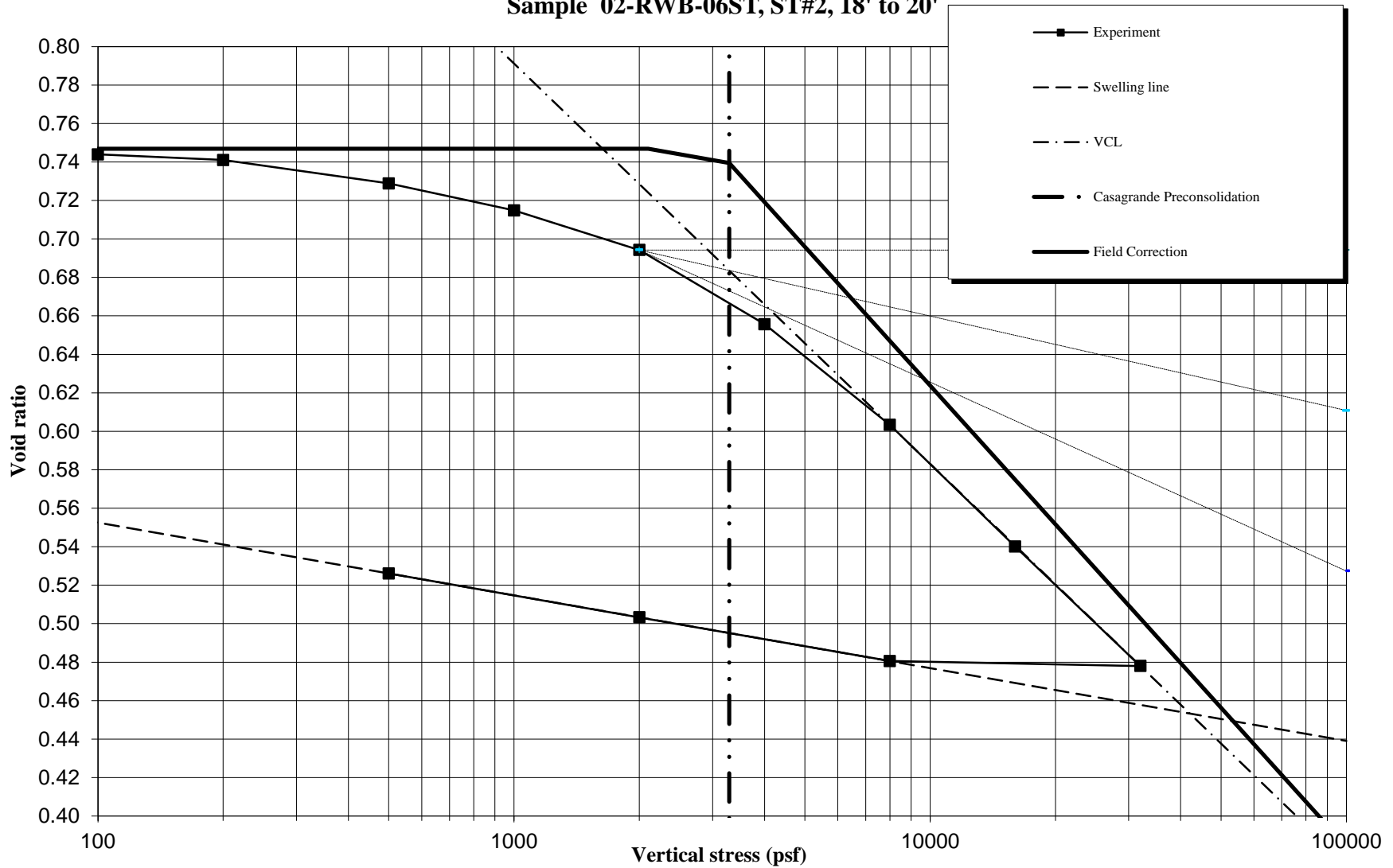

## CONSOLIDATION COEFFICIENT ( $C_v$ ) vs. VERTICAL STRESS

Sample 02-RWB-06ST, ST#2, 18' to 20'

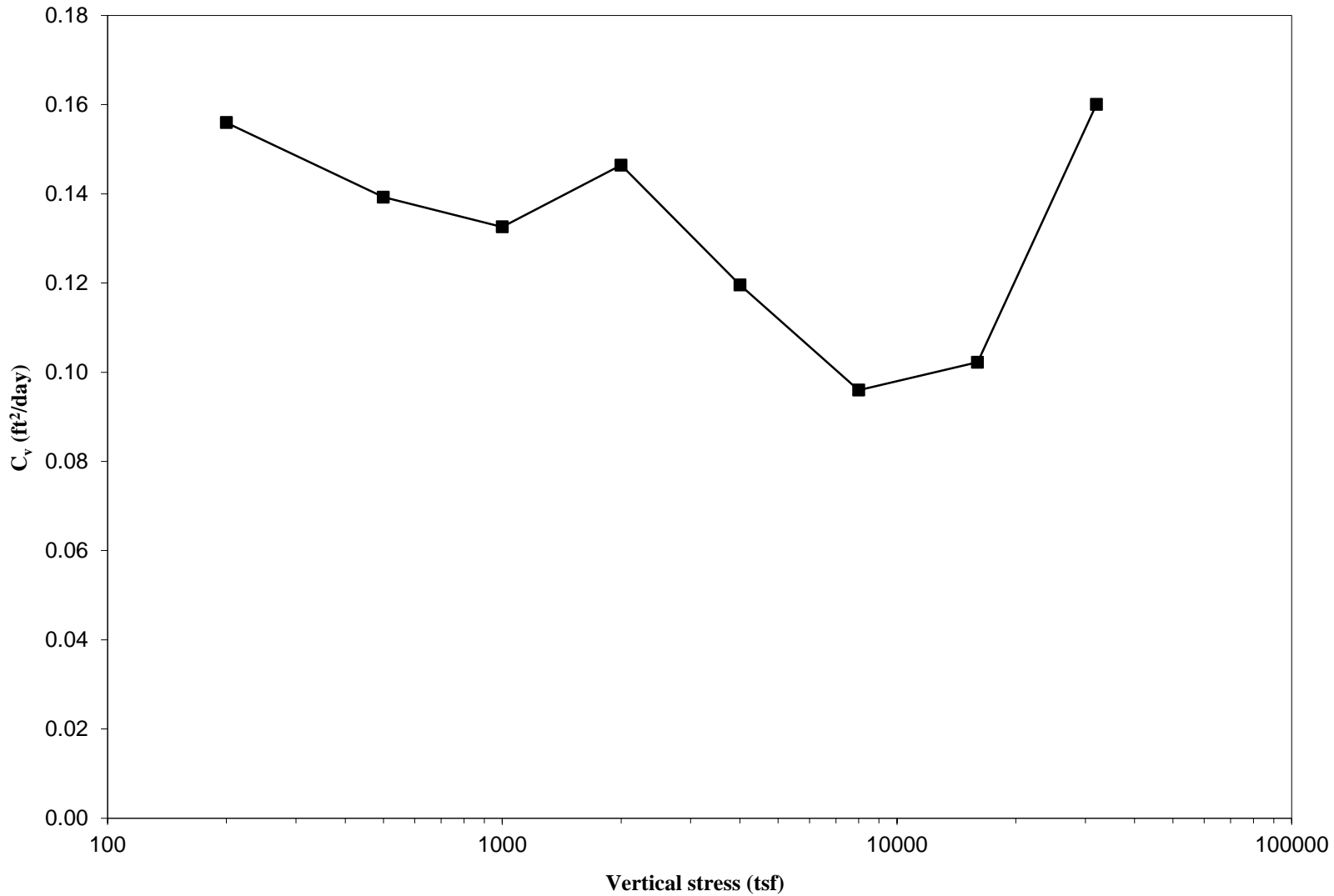



**ONE-DIMENSIONAL CONSOLIDATION TEST**  
**AASHTO T 216 / ASTM D 2435**

**Project:** Circle Interchange  
**Client:** AECOM  
**Soil Sample ID:** Boring 1705-B05A, ST#3, 25' to 27'  
**Sample Description:** Gray LEAN CLAY with trace gravel (CL)

**Tested by:** M. Snider  
**Prepared by:** M. Snider  
**Test date:** 7/30/2013  
**WEI:** 1100-04-01

|                                |            |  |            |
|--------------------------------|------------|--|------------|
| Initial sample height =        | 0.997 in   | Ring diameter =                            | 2.496 in   |
| Initial sample mass =          | 160.54 g   | Ring mass =                                | 109.55 g   |
| Initial water content =        | 25.63%     | Initial sample and ring mass =             | 270.09 g   |
| Initial dry unit weight =      | 99.81 pcf  | Tare mass =                                | 13.58 g    |
| Initial void ratio =           | 0.738      | Final ring and sample mass =               | 262.68 g   |
| Initial degree of saturation = | 96.54%     | Mass of wet sample and tare =              | 166.60 g   |
|                                |            | Mass of dry sample and tare =              | 141.37 g   |
| Final sample mass =            | 153.02 g   | Initial dial reading =                     | 0.01000 in |
| Final dry sample mass =        | 127.79 g   | Final dial reading =                       | 0.12368 in |
| Final water content =          | 19.74%     | LL=  | 33 %       |
| Final dry unit weight =        | 112.66 pcf | PL=  | 17 %       |
| Final void ratio =             | 0.540      | % Sand=                                    | 13.8 %     |
| Final degree of saturation =   | 100.00%    | % Silt=                                    | 49.3 %     |
| Estimated specific gravity =   | 2.78       | % Clay=                                    | 33.9 %     |
|                                |            | <b>In-Situ Vertical Effective Stress =</b> | 2500 psf   |

**Compression and Swelling Indices**

Compression index  $C_c$  = 0.192  
 Field corrected  $C_c$  = 0.223  
 Swelling index  $C_s$  = 0.045

**Preconsolidation pressure,  $s_c$**   
 Casagrande Method = 2886 psf  
**Over-Consolidation Ratio (OCR) =** 1.15

| Load number | Vertical stress<br>psf | Dial reading<br>in | System deflection<br>in | Vertical strain<br>% | Void ratio | $C_v$<br>ft <sup>2</sup> /day | $C_{ae}$<br>% | Elapsed time<br>min |
|-------------|------------------------|--------------------|-------------------------|----------------------|------------|-------------------------------|---------------|---------------------|
| 1           | 100.0                  | 0.01019            | 0.00010                 | 0.03                 | 0.738      | N/A                           | N/A           | 1440                |
| 2           | 200.0                  | 0.01167            | 0.00023                 | 0.19                 | 0.735      | 0.1311                        | 0.06          | 1140                |
| 3           | 500.0                  | 0.01742            | 0.00058                 | 0.80                 | 0.724      | 0.1012                        | 0.07          | 1440                |
| 4           | 1000.0                 | 0.02494            | 0.00090                 | 1.59                 | 0.710      | 0.1030                        | 0.09          | 1380                |
| 5           | 2000.0                 | 0.03802            | 0.00135                 | 2.95                 | 0.687      | 0.1213                        | 0.18          | 1350                |
| 6           | 4000.0                 | 0.06526            | 0.00193                 | 5.74                 | 0.638      | 0.1031                        | 0.37          | 960                 |
| 7           | 8000.0                 | 0.09293            | 0.00253                 | 8.57                 | 0.589      | 0.1018                        | 0.36          | 1440                |
| 8           | 16000.0                | 0.12371            | 0.00324                 | 11.73                | 0.534      | 0.1184                        | 0.38          | 1440                |
| 9           | 32000.0                | 0.15605            | 0.00413                 | 15.06                | 0.476      | 0.1519                        | 0.39          | 1440                |
| 10          | 8000.0                 | 0.15508            | 0.00295                 | 14.85                | 0.480      | N/A                           | N/A           | 480                 |
| 11          | 2000.0                 | 0.14033            | 0.00198                 | 13.27                | 0.507      | N/A                           | N/A           | 2820                |
| 11          | 500.0                  | 0.12566            | 0.00123                 | 11.72                | 0.534      | N/A                           | N/A           | 1440                |

Prepared by: \_\_\_\_\_ Date: \_\_\_\_\_  
 Checked by: \_\_\_\_\_ Date: \_\_\_\_\_



## CONSOLIDATION CURVE

Sample 1705-B05A, ST#3, 25' to 27'

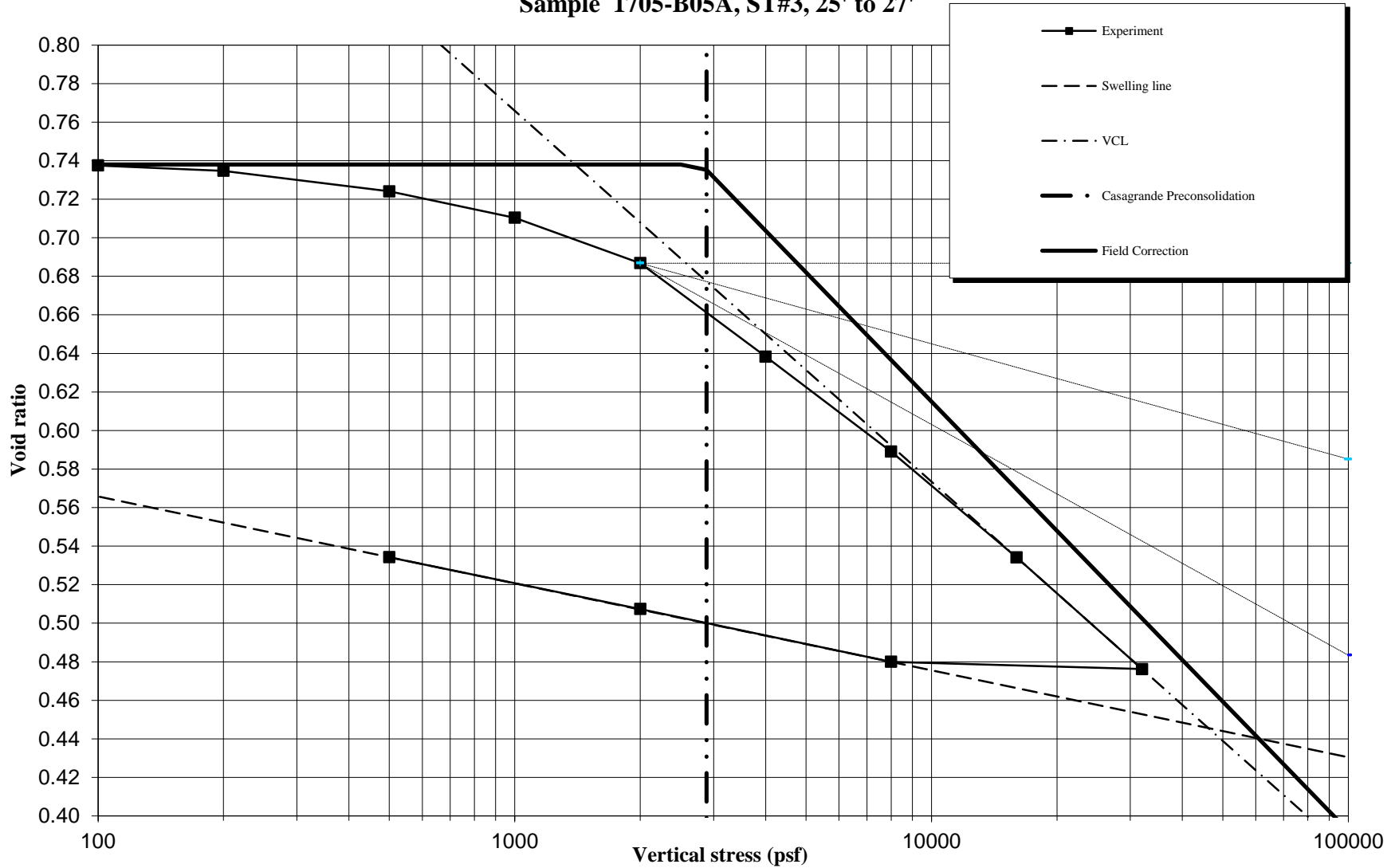

## CONSOLIDATION COEFFICIENT ( $C_v$ ) vs. VERTICAL STRESS

Sample 1705-B05A, ST#3, 25' to 27'

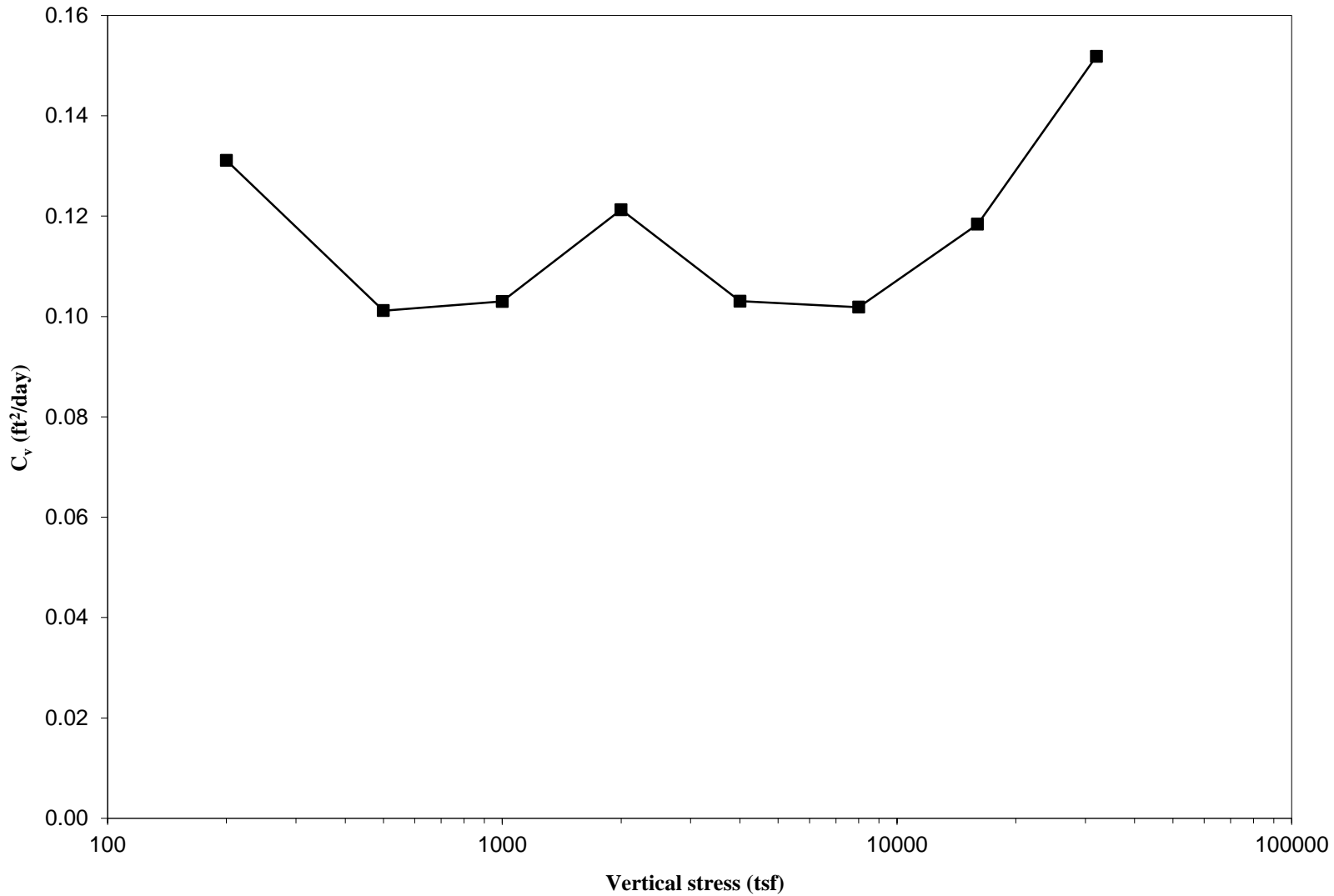

**ONE-DIMENSIONAL CONSOLIDATION TEST**  
**AASHTO T 216 / ASTM D 2435**

**Project:** Circle Interchange  
**Client:** AECOM  
**Soil Sample ID:** Boring 08-ST-01, ST#11, 39' to 41'  
**Sample Description:** Gray CLAY with trace gravel (CL)

**Tested by:** M. Snider  
**Prepared by:** M. Snider  
**Test date:** 1/8/2015  
**WEI:** 1100-04-01

Initial sample height = 1.002 in  
Initial sample mass = 163.22 g  
Initial water content = 25.37%  
Initial dry unit weight = 101.26 pcf  
Initial void ratio = 0.713  
Initial degree of saturation = 98.90%

Final sample mass = 157.86 g  
Final dry sample mass = 130.19 g  
Final water content = 21.25%  
Final dry unit weight = 112.18 pcf  
Final void ratio = 0.546  
Final degree of saturation = 100.00%  
Estimated specific gravity = 2.78

Ring diameter = 2.495 in  
Ring mass = 109.57 g  
Initial sample and ring mass = 272.79 g  
Tare mass = 71.58 g  
Final ring and sample mass = 267.91 g  
Mass of wet sample and tare = 229.44 g  
Mass of dry sample and tare = 201.77 g  
Initial dial reading = 0.01000 in  
Final dial reading = 0.10757 in  
LL= n.a. %  
PL= n.a. %  
% Sand= n.a. %  
% Silt= n.a. %  
% Clay= n.a. %  
**In-Situ Vertical Effective Stress = 3400 psf**

**Compression and Swelling Indices**

Compression index  $C_c$  = 0.182  
Field corrected  $C_c$  = 0.219  
Swelling index  $C_s$  = 0.051

**Preconsolidation pressure,  $s_c$**   
Casagrande Method = 3586 psf  
**Over-Consolidation Ratio (OCR) = 1.05**

| Load number | Vertical stress<br>psf | Dial reading<br>in | System deflection<br>in | Vertical strain<br>% | Void ratio | $C_v$<br>ft <sup>2</sup> /day | $C_{ae}$<br>% | Elapsed time<br>min |
|-------------|------------------------|--------------------|-------------------------|----------------------|------------|-------------------------------|---------------|---------------------|
| 1           | 100.0                  | 0.00988            | 0.00010                 | 0.00                 | 0.713      | N/A                           | N/A           | 1245                |
| 2           | 200.0                  | 0.01152            | 0.00023                 | 0.17                 | 0.710      | 0.0635                        | 0.07          | 2775                |
| 3           | 500.0                  | 0.01982            | 0.00058                 | 1.04                 | 0.695      | 0.0811                        | 0.10          | 1788                |
| 4           | 1000.0                 | 0.02901            | 0.00090                 | 1.99                 | 0.679      | 0.0809                        | 0.10          | 1410                |
| 5           | 2000.0                 | 0.04280            | 0.00135                 | 3.41                 | 0.655      | 0.0851                        | 0.16          | 1440                |
| 6           | 4000.0                 | 0.06159            | 0.00193                 | 5.34                 | 0.622      | 0.0814                        | 0.26          | 1344                |
| 7           | 8000.0                 | 0.08722            | 0.00253                 | 7.96                 | 0.577      | 0.0889                        | 0.32          | 3270                |
| 8           | 16000.0                | 0.11708            | 0.00324                 | 11.01                | 0.525      | 0.0832                        | 0.43          | 1944                |
| 9           | 32000.0                | 0.14821            | 0.00413                 | 14.21                | 0.470      | 0.1154                        | 0.37          | 1440                |
| 10          | 8000.0                 | 0.14412            | 0.00295                 | 13.68                | 0.479      | N/A                           | N/A           | 1440                |
| 11          | 2000.0                 | 0.12727            | 0.00198                 | 11.90                | 0.509      | N/A                           | N/A           | 1440                |
| 11          | 500.0                  | 0.10982            | 0.00123                 | 10.08                | 0.540      | N/A                           | N/A           | 3240                |

Prepared by: \_\_\_\_\_ Date: \_\_\_\_\_

Checked by: \_\_\_\_\_ Date: \_\_\_\_\_

## CONSOLIDATION CURVE

Sample 08-ST-01, ST#11, 39' to 41'

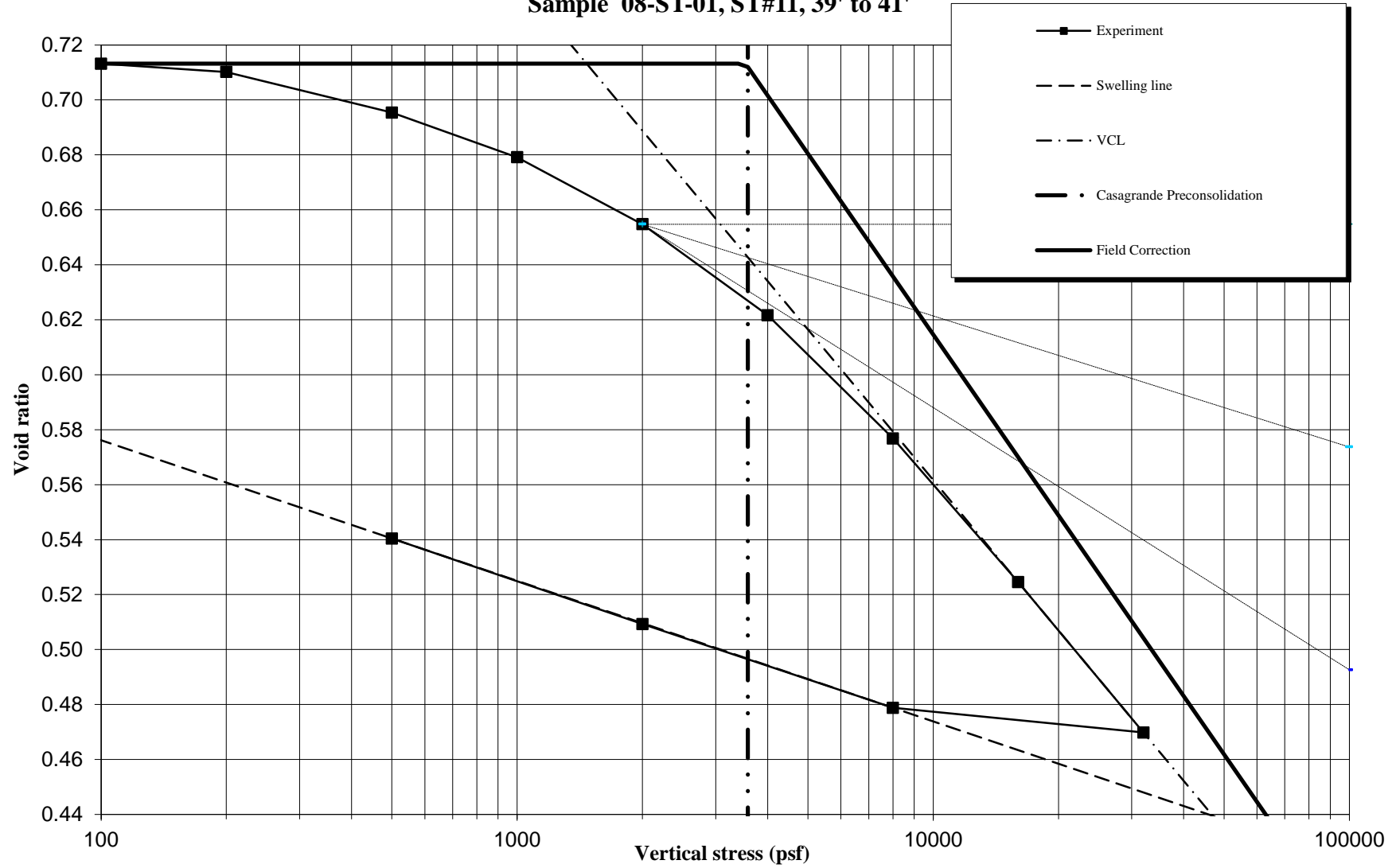

## CONSOLIDATION COEFFICIENT ( $C_v$ ) vs. VERTICAL STRESS

Sample 08-ST-01, ST#11, 39' to 41'

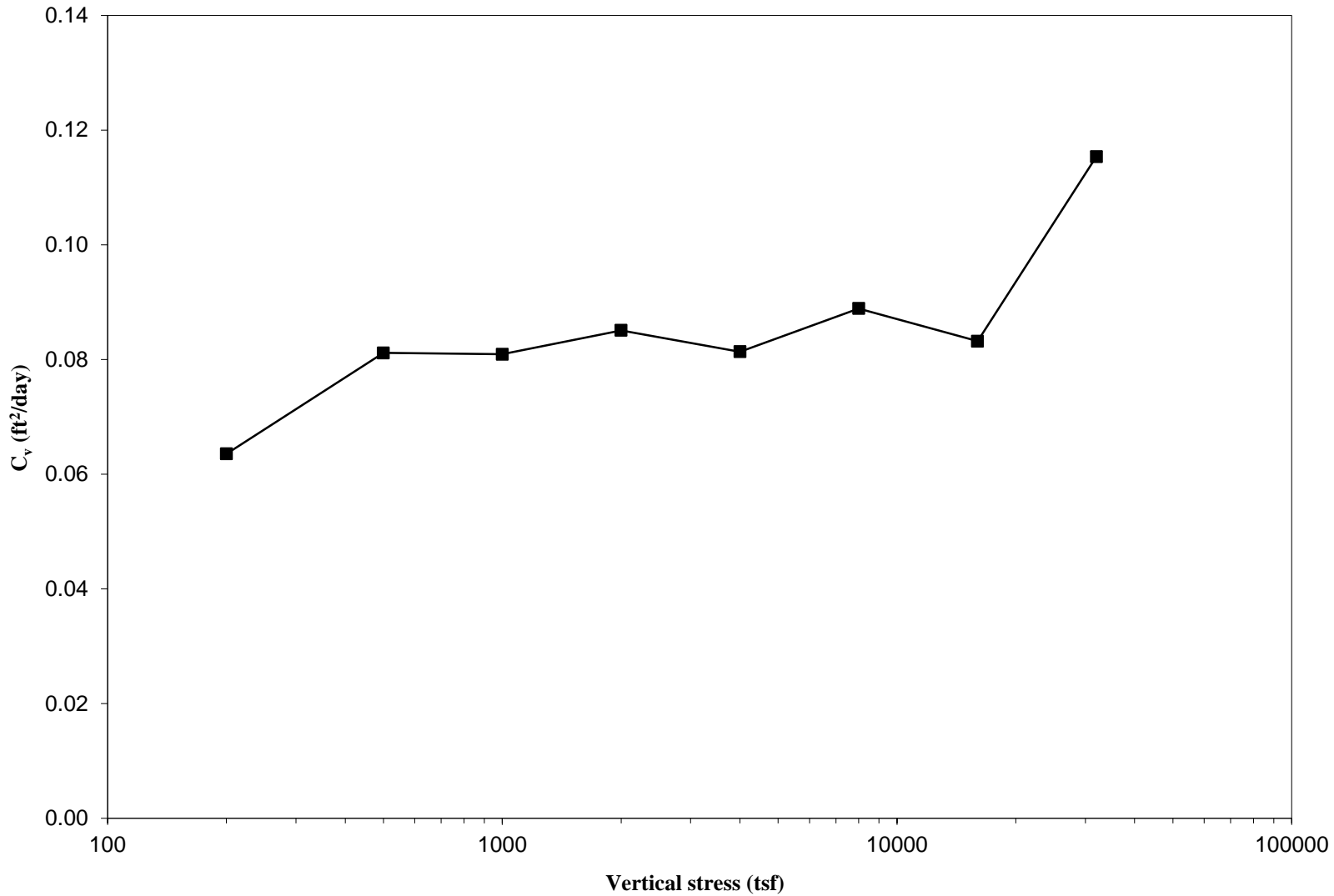



## **APPENDIX C**

Bench Mark: Chisel "X" on chain bolt of fire hydrant in front of 555 W. Harrison St. Elev. 594.46.

Existing Structure: None.

The existing bridge will be closed and traffic will be detoured during construction. Traffic on I-290 and I-90/94 will be maintained with stage construction.

No Salvage.

**NOTES:**

1. Wall offsets are measured from the  $\text{C}$  of Taylor St. Bypass Ramp to the front face of precast panels.
2. F.F. denotes Front Face.
3. B.F. denotes Back Face.
4. Aggregate columns must be spaced to avoid interference with existing utilities to remain, proposed utilities to be installed, and proposed abutment foundation.
5. All proposed drainage structure locations along I-90/94 are conceptual at this stage and are subject to refinement during final design.

**HIGHWAY CLASSIFICATION**

| SB I-90/94 Taylor St. Bypass Ramp | Ramp NW                           |
|-----------------------------------|-----------------------------------|
| Functional Class: Interstate      | Functional Class: Interstate      |
| ADT: NA (2012); 8,000 (2040)      | ADT: 32,500 (2012); 36,000 (2040) |
| ADTT: NA (2012); 240 (2040)       | ADTT: 2,483 (2012); 2,730 (2040)  |
| DHV: 590 (2040)                   | DHV: 2,790 (2040)                 |
| Design Speed: 25 m.p.h.           | Design Speed: 35 m.p.h.           |
| Posted Speed: 25 m.p.h.           | Posted Speed: 35 m.p.h.           |
| One-Way Traffic                   | One-Way Traffic                   |
| Directional Distribution: 100%    | Directional Distribution: 100%    |

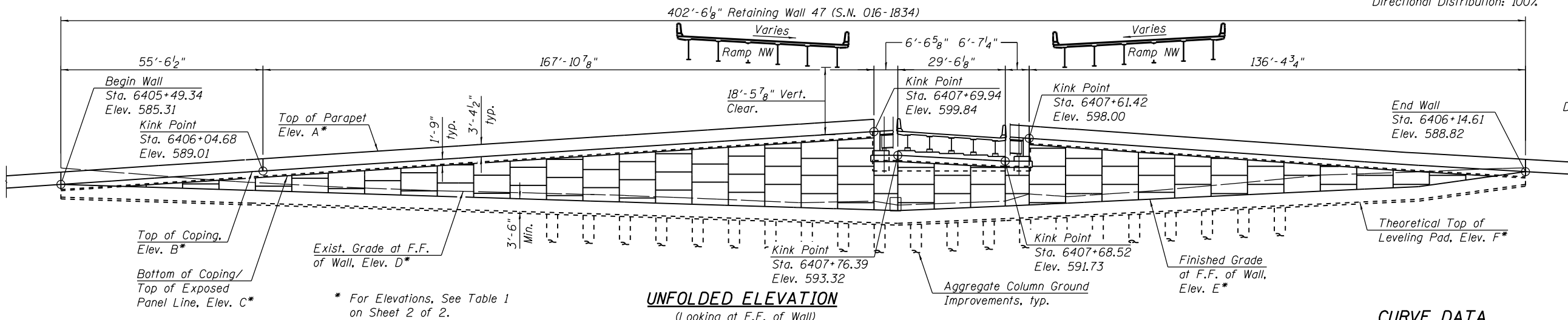

**DESIGN SPECIFICATIONS**

2014 AASHTO LRFD Bridge Design Specifications 7th Edition with 2015 and 2016 Interim Specifications

**DESIGN STRESSES**

**FIELD UNITS**

f'c = 3,500 psi  
fy = 60,000 psi (Reinforcement)

**PRECAST UNITS**

f'c = 4,500 psi

**CURVE DATA**

(Along  $\text{C}$  of Taylor St. Bypass Ramp)

P-TAY-SX-2  
P.I. Sta. = 6408+06.27  
 $\Delta = 65^\circ 55' 10''$  (LT)  
D = 17° 28' 06"  
R = 328.00'  
T = 212.68'  
L = 377.37'  
E = 62.92'  
e = 5.00%  
T.R. = 46'  
S.E. Run = 114'  
P.C. Sta. = 6405+93.59  
P.T. Sta. = 6409+70.96

**LEGEND**

|   |                     |
|---|---------------------|
| Electric  | — E —               |
| Fiber Optic   | — FO —              |
| Exist. Storm Sewer                                    | — S —               |
| Light Pole  | ⊙                   |
| Soil Boring   | ⊕                   |
| Limits of Soil Reinforcement                          | [Hatched Box]       |
| Limits of Soil Reinforcement With Ground Improvements | [Cross-hatched Box] |

**CURVE DATA**

(Ramp NW)

P-CIR-NW-6  
P.I. Sta. = 1831+44.22  
 $\Delta = 88^\circ 30' 25''$  (LT)  
D = 10° 36' 37"  
R = 540.00'  
T = 526.11'  
L = 834.16'  
E = 213.92'  
e = 5.4%  
T.R. = NA  
S.E. Run = 66'  
P.C. Sta. = 1826+18.11  
P.T. Sta. = 1834+52.27

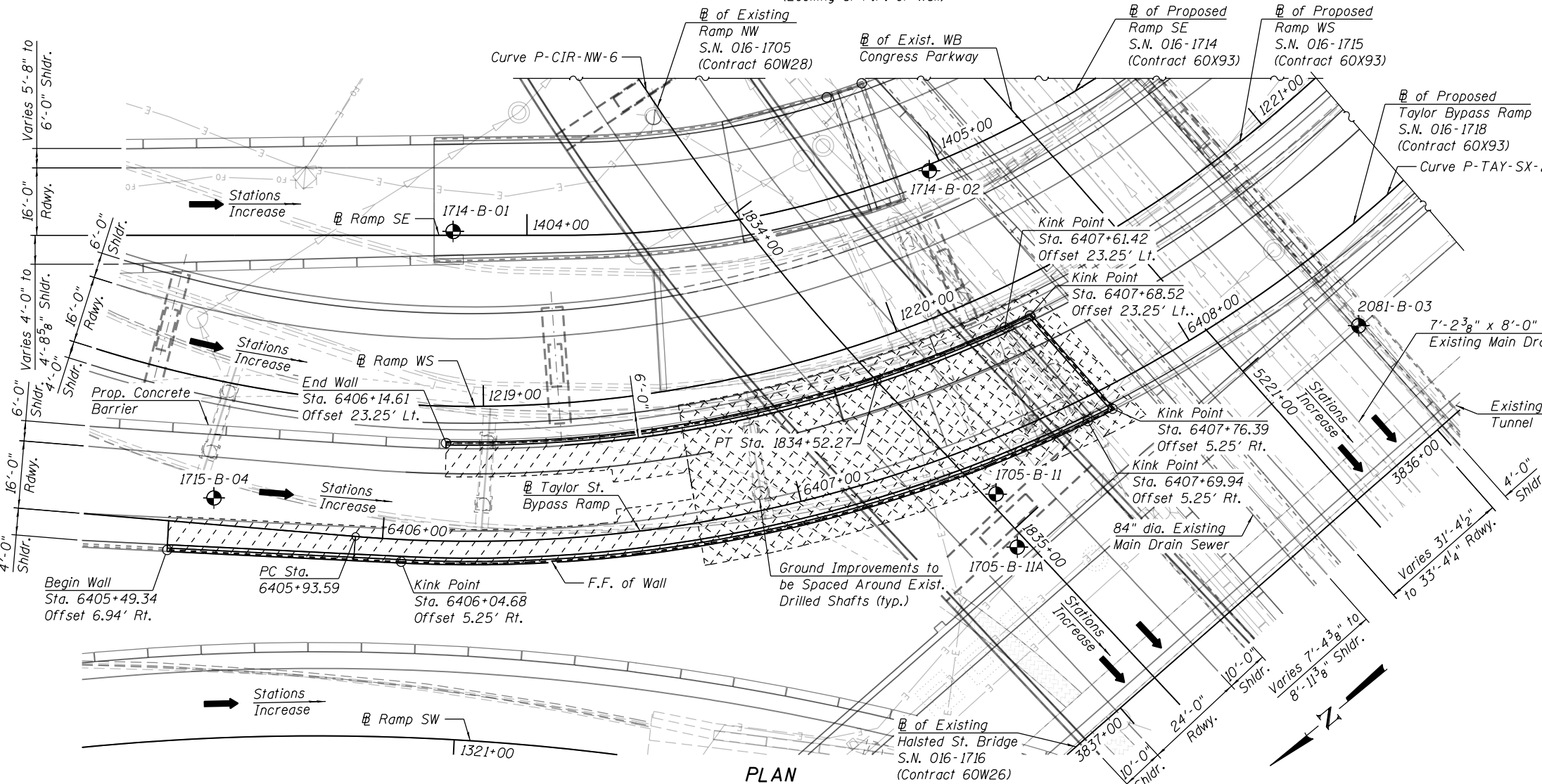
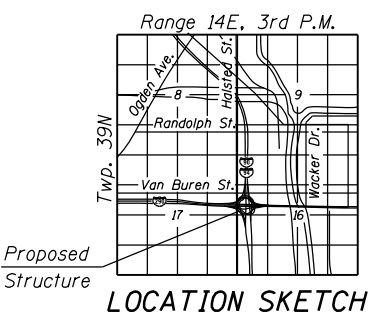

**GENERAL PLAN**  
**RETAINING WALL 47 ALONG**  
**F.A.I 94 (SB I-90/94 TAYLOR ST. BYPASS RAMP)**  
**SECTION 2014-013 R&B-R**  
**COOK COUNTY**  
**STATION 6405+49.34 TO STATION 6407+76.39**  
**STRUCTURE NO. 016-1834**



|                           |               |           |
|---------------------------|---------------|-----------|
| USER NAME = jrmickens     | DESIGNED - JM | REVISED - |
| PLOT SCALE = 32.00' / in. | CHECKED - WJC | REVISED - |
| PLOT DATE = 8/21/2017     | DRAWN - JM    | REVISED - |
|                           | CHECKED - TLR | REVISED - |

**STATE OF ILLINOIS**  
**DEPARTMENT OF TRANSPORTATION**

SHEET NO. 1 OF 3 SHEETS

| F.A.I. RTE.        | SECTION        | COUNTY | TOTAL SHEETS              | SHEET NO. |
|--------------------|----------------|--------|---------------------------|-----------|
| 90/94/290          | 2014-013 R&B-R | COOK   | 3                         | 1         |
| CONTRACT NO. 60X93 |                |        | ILLINOIS FED. AID PROJECT |           |

9/29/06 AM - p:\w\617479-P\WINT\_cocmonline\local\ECOM\DS02\_NA\Documents\01\americas\Transportation\60269938\_Circle\Phase\_II\000\_CAD\008\_Structural\Structure\_016-183A\TSL\Sheets\016834-60X93-SHT-TSL-002

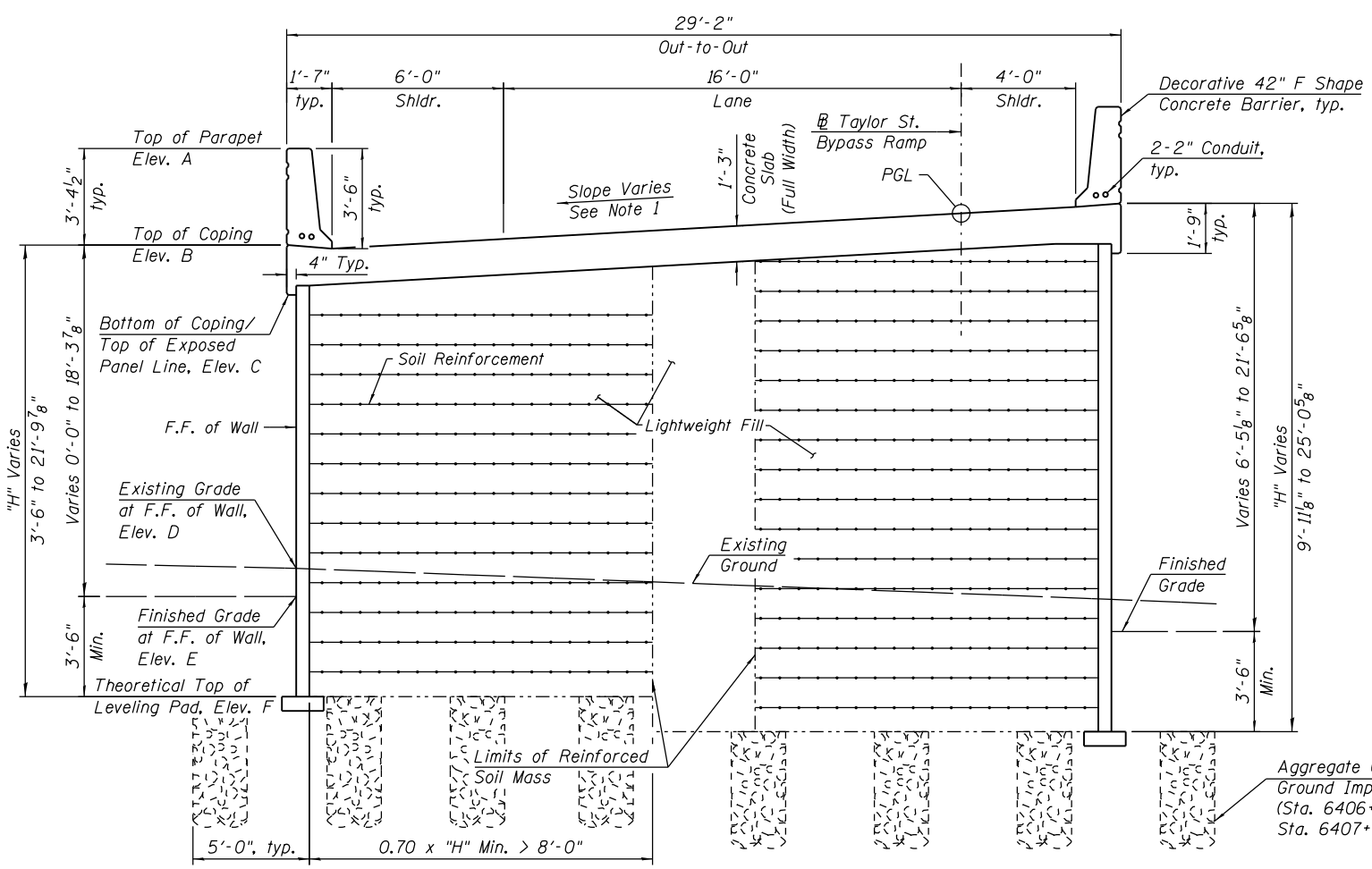

**CROSS SECTION**  
(Sta. 6406+14.61 to Sta. 6407+76.39)  
(Looking Upstation)

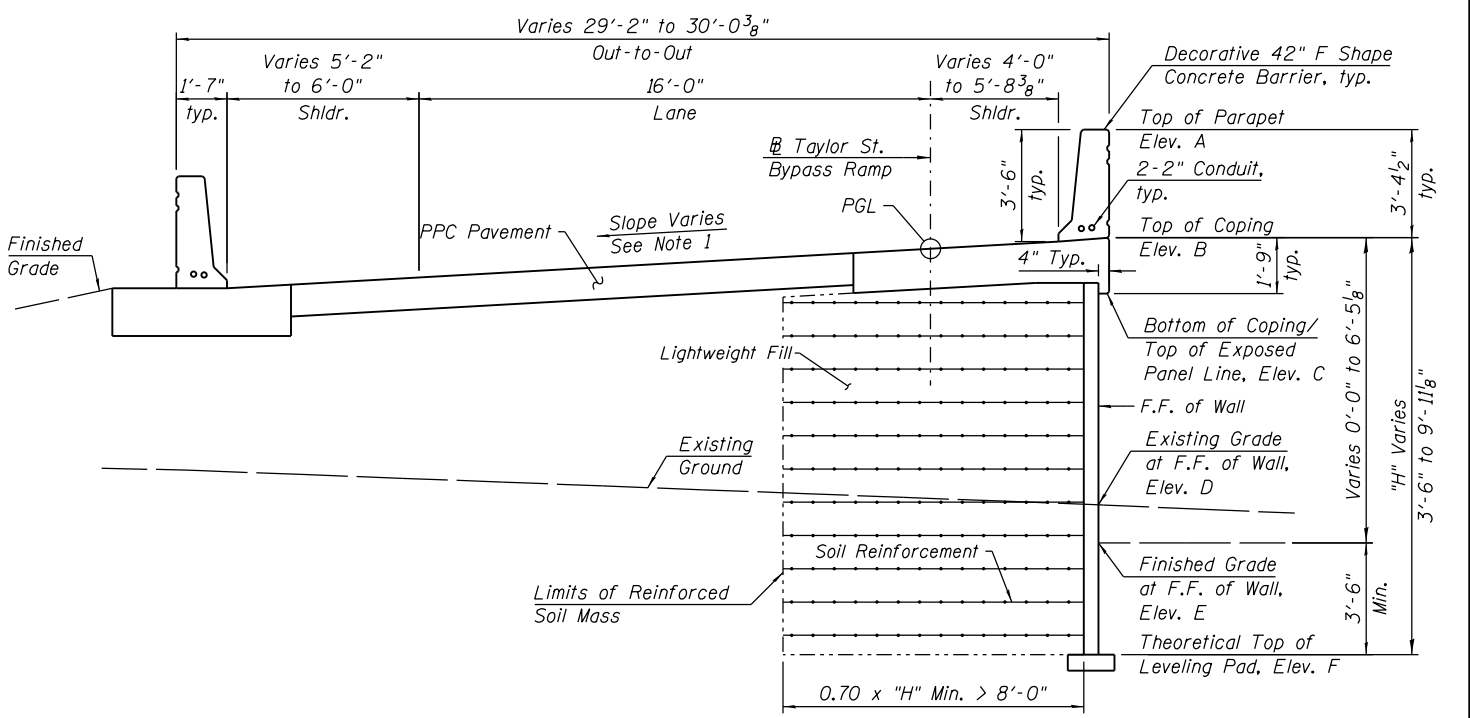

**CROSS SECTION**  
(Sta. 6405+49.34 to Sta. 6406+14.61)  
(Looking Upstation)

**TABLE 1 - WALL ELEVATIONS**

| Station    | Offset     | Elevation A | Elevation B | Elevation C | Elevation D | Elevation E | Elevation F |
|------------|------------|-------------|-------------|-------------|-------------|-------------|-------------|
| 6405+49.34 | 6.94' Rt.  | 588.69      | 585.31      | 583.56      | 589.82      | 585.31      | 581.81      |
| 6405+75.00 | 6.07' Rt.  | 590.41      | 587.04      | 585.29      | 587.79      | 584.51      | 581.01      |
| 6405+93.59 | 5.44' Rt.  | 591.65      | 588.27      | 586.52      | 586.31      | 583.92      | 580.42      |
| 6406+04.68 | 5.25' Rt.  | 592.38      | 589.01      | 587.26      | 585.69      | 583.57      | 580.07      |
| 6406+14.61 | 5.25' Rt.  | 593.05      | 589.67      | 587.92      | 585.19      | 583.25      | 579.75      |
| 6406+25.00 | 5.25' Rt.  | 593.74      | 590.37      | 588.62      | 584.61      | 582.92      | 579.42      |
| 6406+50.00 | 5.25' Rt.  | 595.42      | 592.04      | 590.29      | 583.61      | 582.12      | 578.62      |
| 6406+75.00 | 5.25' Rt.  | 597.05      | 593.67      | 591.92      | 583.02      | 581.32      | 577.82      |
| 6407+00.00 | 5.25' Rt.  | 598.67      | 595.30      | 593.55      | 582.36      | 580.52      | 577.02      |
| 6407+25.00 | 5.25' Rt.  | 600.30      | 596.92      | 595.17      | 581.36      | 579.73      | 576.23      |
| 6407+50.00 | 5.25' Rt.  | 601.92      | 598.55      | 596.80      | 580.28      | 578.93      | 575.43      |
| 6407+69.94 | 5.25' Rt.  | 603.22      | 599.85      | 598.10      | 580.70      | 578.29      | 574.79      |
| 6407+76.39 | 5.25' Rt.  | -           | 593.33      | 591.58      | 579.62      | 578.09      | 574.59      |
| 6407+68.52 | 23.25' Lt. | -           | 591.72      | 589.97      | 580.71      | 579.36      | 575.86      |
| 6407+61.42 | 23.25' Lt. | 601.37      | 597.99      | 596.24      | 582.67      | 579.67      | 576.17      |
| 6407+50.00 | 23.25' Lt. | 600.62      | 597.25      | 595.50      | 581.94      | 580.17      | 576.67      |
| 6407+25.00 | 23.25' Lt. | 599.00      | 595.62      | 593.87      | 583.53      | 581.26      | 577.76      |
| 6407+00.00 | 23.25' Lt. | 597.37      | 594.00      | 592.25      | 585.60      | 582.35      | 578.85      |
| 6406+75.00 | 23.25' Lt. | 595.75      | 592.37      | 590.62      | 587.87      | 583.44      | 579.94      |
| 6406+50.00 | 23.25' Lt. | 594.14      | 590.76      | 589.01      | 588.64      | 584.54      | 581.04      |
| 6406+46.27 | 23.25' Lt. | 593.94      | 590.56      | 588.81      | 588.76      | 584.70      | 581.20      |
| 6406+25.00 | 23.25' Lt. | 592.77      | 589.39      | 587.64      | 589.62      | 587.47      | 583.97      |
| 6406+14.61 | 23.25' Lt. | 592.20      | 588.82      | 587.07      | 589.88      | 588.82      | 585.32      |

Elevation A - Top of Parapet  
 Elevation B - Top of Coping  
 Elevation C - Bottom of Coping / Top of Exposed Panel Line  
 Elevation D - Existing Grade at F.F. of Wall  
 Elevation E - Finished Grade at F.F. of Wall  
 Elevation F - Theoretical Top of Leveling Pad

**NOTES:**

- Direction of slope referenced from right edge of pavement.  
 Slope Transition (0.00% to -5.00%) Sta. 6405+43.92 to Sta. 6406+51.92  
 Constant Cross Slope (-5.00%) Sta. 6406+51.92 to Sta. 6409+32.86

**CROSS SECTIONS**  
**RETAINING WALL 47 ALONG**  
**F.A.I. 94 (SB I-90/94 TAYLOR ST. BYPASS RAMP)**  
**SECTION 2014-013 R&B-R**  
**COOK COUNTY**  
**STATION 6405+49.34 TO STATION 6407+76.39**  
**STRUCTURE NO. 016-1834**



|                            |               |           |
|----------------------------|---------------|-----------|
| USER NAME = jrmickens      | DESIGNED - JM | REVISED - |
| PLOT SCALE = 6.0000' / in. | CHECKED - WJC | REVISED - |
| PLOT DATE = 8/21/2017      | DRAWN - JM    | REVISED - |
|                            | CHECKED - TLR | REVISED - |

**STATE OF ILLINOIS**  
**DEPARTMENT OF TRANSPORTATION**

|                           |                |        |              |           |
|---------------------------|----------------|--------|--------------|-----------|
| F.A.I. RTE.               | SECTION        | COUNTY | TOTAL SHEETS | SHEET NO. |
| 90/94/290                 | 2014-013 R&B-R | COOK   | 3            | 2         |
| CONTRACT NO.              |                |        | 60X93        |           |
| ILLINOIS FED. AID PROJECT |                |        |              |           |

9:29:50 AM - p:\w\617179-PWINT\cecomonline\local\ECOM\DS02\_NA\Documents\01\Americas\Transportation\60269938\_Circle\Phase II\000\_CAD\008\_Structural\Structure\_016-1834-TSL\Sheets\016-1834-SHT-TSL-003

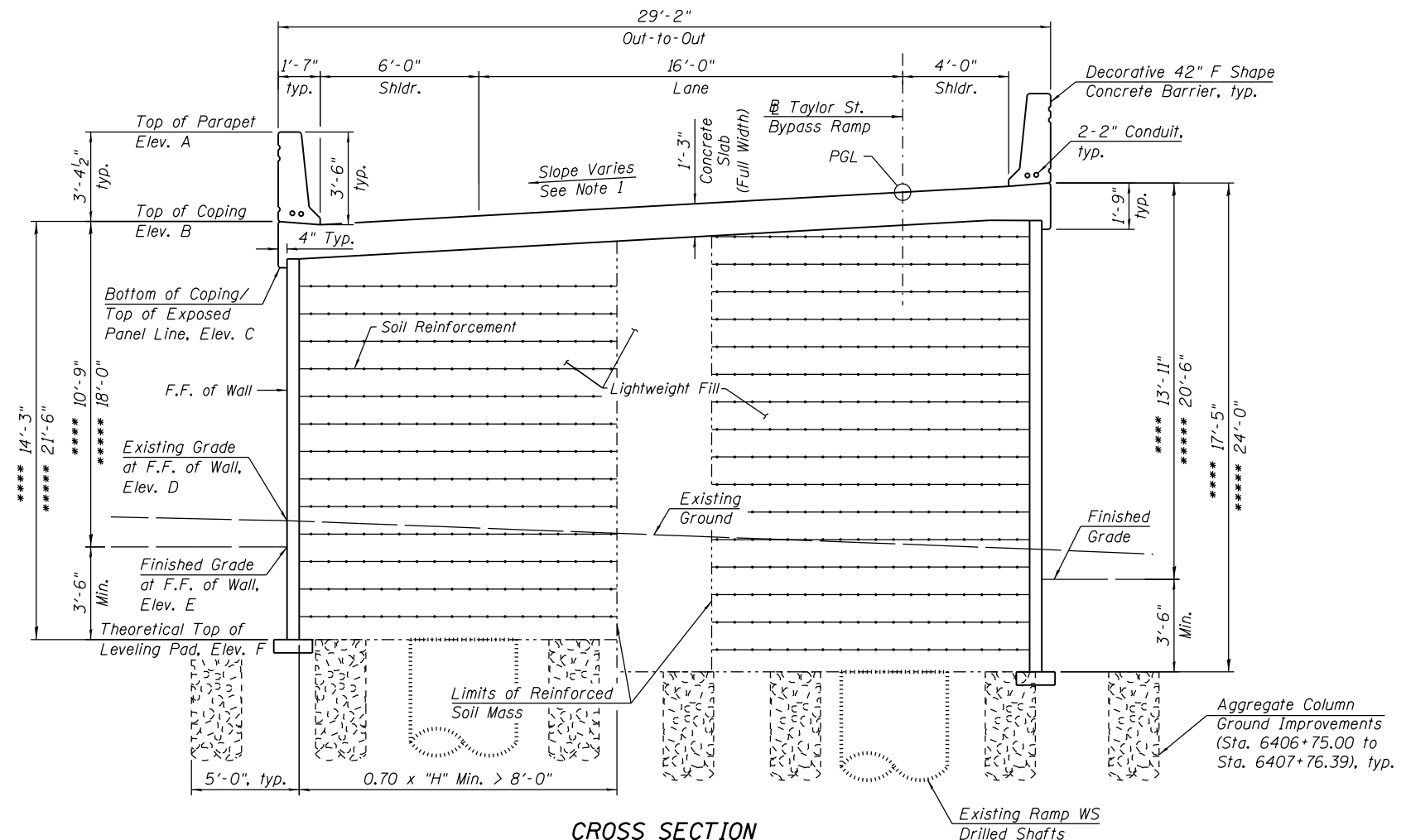

**CROSS SECTION**  
 (Sta. 6406+59.00 \*\*\*\*\*)  
 (Sta. 6406+91.50 \*\*\*\*\*)  
 (Looking Upstation)

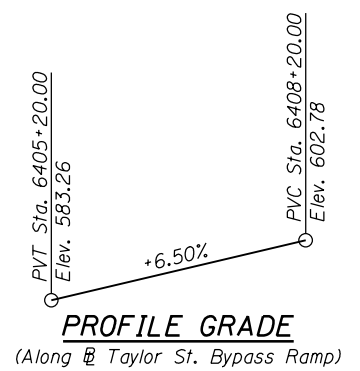
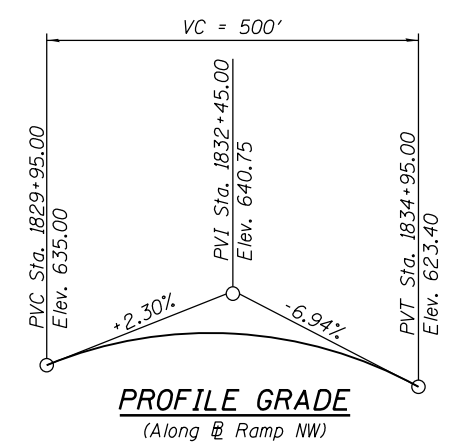

- \* Abutment Soil Reinforcement to resist lateral loads in lieu of drilled shafts.
- \*\* Size, spacing and number to be determined in design.
- \*\*\* The M.S.E. Wall supplier's internal stability design shall account for the anchorage slab's bearing pressure surcharge of 1.0 ksf and horizontal sliding force of 0.83 kips/ft of wall.

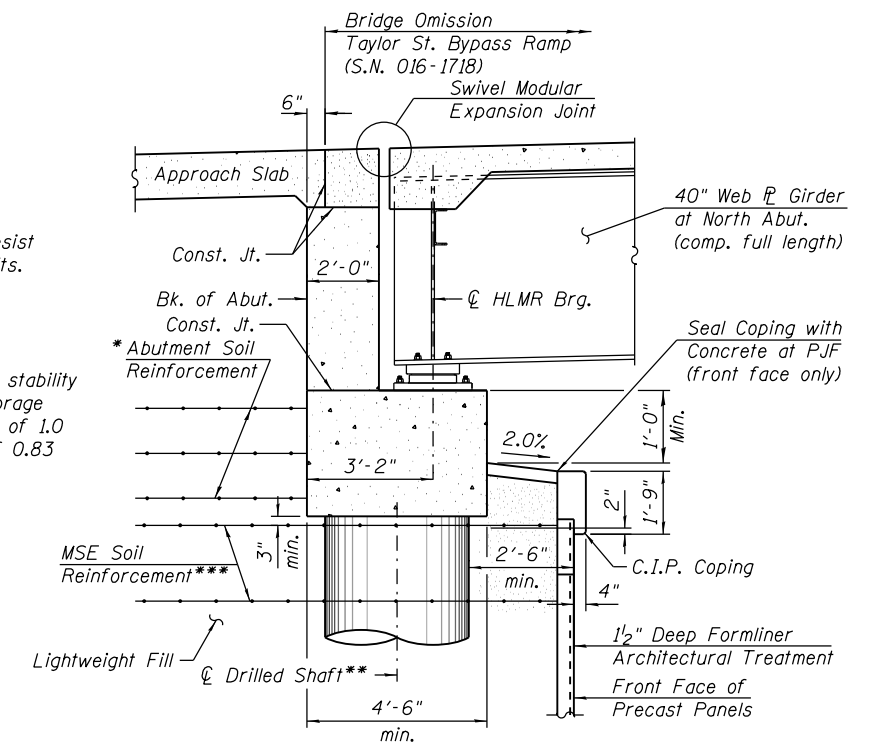

**SECTION THRU ABUTMENT**  
 (Horiz. Dim. @ Rt. L's)

**CROSS SECTION & DETAILS**  
**RETAINING WALL 47 ALONG**  
**F.A.I. 94 (SB I-90/94 TAYLOR ST. BYPASS RAMP)**  
**SECTION 2014-013 R&B-R**  
**COOK COUNTY**  
**STATION 6405+49.34 TO STATION 6407+76.39**  
**STRUCTURE NO. 016-1834**



|                            |               |           |
|----------------------------|---------------|-----------|
| USER NAME = jrmickens      | DESIGNED - JM | REVISED - |
| PLOT SCALE = 6.0000' / in. | CHECKED - WJC | REVISED - |
| PLOT DATE = 8/21/2017      | DRAWN - JM    | REVISED - |
|                            | CHECKED - TLR | REVISED - |

**STATE OF ILLINOIS**  
**DEPARTMENT OF TRANSPORTATION**

|                       |                        |             |                           |             |
|-----------------------|------------------------|-------------|---------------------------|-------------|
| F.A.I. RTE. 90/94/290 | SECTION 2014-013 R&B-R | COUNTY COOK | TOTAL SHEETS 3            | SHEET NO. 3 |
| CONTRACT NO. 60X93    |                        |             | ILLINOIS FED. AID PROJECT |             |