

If you plan to submit a bid directly to the Department of Transportation

PREQUALIFICATION

Any contractor who desires to become pre-qualified to bid on work advertised by IDOT must submit the properly completed pre-qualification forms to the Bureau of Construction no later than 4:30 p.m. prevailing time twenty-one days prior to the letting of interest. This pre-qualification requirement applies to first time contractors, contractors renewing expired ratings, contractors maintaining continuous pre-qualification or contractors requesting revised ratings. To be eligible to bid, existing pre-qualification ratings must be effective through the date of letting.

REQUESTS FOR AUTHORIZATION TO BID

Contractors downloading and/or ordering CD-ROM's and are wanting to bid on items included in a particular letting must submit the properly completed "Request for Authorization to Bid/or Not For Bid Status" (BDE 124INT) and the ORIGINAL, signed and notarized, "Affidavit of Availability" (BC 57) to the proper office no later than 4:30 p.m. prevailing time, three (3) days prior to the letting date.

WHO CAN BID ?

Bids will be accepted from only those companies that request and receive written **Authorization to Bid** from IDOT's Central Bureau of Construction.

WHAT CONSTITUTES WRITTEN AUTHORIZATION TO BID? When a prospective prime bidder submits a "Request for Authorization to Bid/or Not For Bid Status" (BDE 124INT) he/she must indicate at that time which items are being requested For Bidding purposes. Only those items requested For Bidding will be analyzed. After the request has been analyzed, the bidder will be issued a **Proposal Denial and/or Authorization Form**, approved by the Central Bureau of Construction, that indicates which items have been approved For Bidding. If **Authorization to Bid** cannot be approved, the **Proposal Denial and/or Authorization Form** will indicate the reason for denial.

ABOUT AUTHORIZATION TO BID: Firms that have not received an authorization form within a reasonable time of complete and correct original document submittal should contact the department as to status. This is critical in the week before the letting. These documents must be received three days before the letting date. Firms unsure as to authorization status should call the Prequalification Section of the Bureau of Construction at the number listed at the end of these instructions.

ADDENDA AND REVISIONS: It is the contractor's responsibility to determine which, if any, addenda or revisions pertain to any project they may be bidding. Failure to incorporate all relevant addenda or revisions may cause the bid to be declared unacceptable.

Each addendum will be placed with the contract number. Addenda and revisions will also be placed on the Addendum/Revision Checklist and each subscription service subscriber will be notified by e-mail of each addendum and revision issued.

The Internet is the Department's primary way of doing business. The subscription server e-mails are an added courtesy the Department provides. It is suggested that bidder check IDOT's website <http://www.dot.il.gov/desenv/delett.html> before submitting final bid information.

IDOT is not responsible for any e-mail related failures.

Addenda Questions may be directed to the Contracts Office at (217)782-7806 or D&Econtracts@dot.il.gov

Technical Questions about downloading these files may be directed to Tim Garman (217)524-1642 or garmantr@dot.il.gov.

WHAT MUST BE INCLUDED WHEN BIDS ARE SUBMITTED?: Bidders need not return the entire proposal when bids are submitted. That portion of the proposal that must be returned includes the following:

1. All documents from the Proposal Cover Sheet through the Proposal Bid Bond
2. Other special documentation and/or information that may be required by the contract special provisions

All proposal documents, including Proposal Guaranty Checks or Proposal Bid Bonds, should be stapled together to prevent loss when bids are processed by IDOT personnel.

ABOUT SUBMITTING BIDS: It is recommended that bidders deliver bids in person to insure they arrive at the proper location prior to the time specified for the receipt of bids. Any bid received at the place of letting after the time specified will not be accepted.

WHO SHOULD BE CALLED IF ASSISTANCE IS NEEDED?

Questions Regarding	Call
Prequalification and/or Authorization to Bid	(217)782-3413
Preparation and submittal of bids	(217)782-7806
Mailing of plans and proposals	(217)782-7806
Electronic plans and proposals	(217)524-1642

ADDENDUMS AND REVISIONS TO THE PROPOSAL FORMS

Planholders should verify that they have received and incorporated the addendum and/or revision prior to submitting their bid. Failure by the bidder to include an addendum could result in a bid being rejected as irregular.

90

RETURN WITH BID

Proposal Submitted By
Name
Address
City

Letting November 16, 2007

BIDDERS NEED NOT RETURN THE ENTIRE PROPOSAL
(See instructions inside front cover)

NOTICE TO PROSPECTIVE BIDDERS
 This proposal can be used for bidding purposes by only those companies that request and receive written AUTHORIZATION TO BID from IDOT's Central Bureau of Construction.
 (SEE INSTRUCTIONS ON THE INSIDE OF COVER)

Notice To Bidders, Specifications, Proposal, Contract and Contract Bond



**Illinois Department
of Transportation**

Springfield, Illinois 62764

**Contract No. 64D31
WHITESIDE County
Section D2 SPRING RS 2007-2
District 2 Construction Funds
Route FAP 309**

PLEASE MARK THE APPROPRIATE BOX BELOW:

A Bid Bond is included.

A Cashier's Check or a Certified Check is included.

Plans Included
Herein

Prepared by	
Checked by	S

(Printed by authority of the State of Illinois)

INSTRUCTIONS

ABOUT IDOT PROPOSALS: All proposals issued by IDOT are potential bidding proposals. Each proposal contains all Certifications and Affidavits, a Proposal Signature Sheet and a Proposal Bid Bond required for Prime Contractors to submit a bid after written **Authorization to Bid** has been issued by IDOT's Central Bureau of Construction.

WHO CAN BID?: Bids will be accepted from only those companies that request and receive written **Authorization to Bid** from IDOT's Central Bureau of Construction. To request authorization, a potential bidder must complete and submit Part B of the Request for Authorization to Bid/or Not For Bid Status form (BDE 124 INT) and submit an original Affidavit of Availability (BC 57).

WHAT CONSTITUTES WRITTEN AUTHORIZATION TO BID?: When a prospective prime bidder submits a "Request for Proposal Forms and Plans" he/she must indicate at that time which items are being requested For Bidding purposes. Only those items requested For Bidding will be analyzed. After the request has been analyzed, the bidder will be issued a **Proposal Denial and/or Authorization Form**, approved by the Central Bureau of Construction, that indicates which items have been approved For Bidding. If **Authorization to Bid** cannot be approved, the **Proposal Denial and/or Authorization Form** will indicate the reason for denial. If a contractor has requested to bid but has not received a **Proposal Denial and/or Authorization Form**, they should contact the Central Bureau of Construction in advance of the letting date.

WHAT MUST BE INCLUDED WHEN BIDS ARE SUBMITTED?: Bidders need not return the entire proposal when bids are submitted. That portion of the proposal that must be returned includes the following:

1. All documents from the Proposal Cover Sheet through the Proposal Bid Bond
2. Other special documentation and/or information that may be required by the contract special provisions

All proposal documents, including Proposal Guaranty Checks or Proposal Bid Bonds, should be stapled together to prevent loss when bids are processed by IDOT personnel.

ABOUT SUBMITTING BIDS: It is recommended that bidders deliver bids in person to insure they arrive at the proper location prior to the time specified for the receipt of bids. Any bid received at the place of letting after the time specified will not be accepted.

WHO SHOULD BE CALLED IF ASSISTANCE IS NEEDED?

Questions Regarding	Call
Prequalification and/or Authorization to Bid	217/782-3413
Preparation and submittal of bids	217/782-7806
Mailing of CD-ROMS	217/782-7806

RETURN WITH BID



PROPOSAL

TO THE DEPARTMENT OF TRANSPORTATION

1. Proposal of _____

Taxpayer Identification Number (Mandatory) _____ a

for the improvement identified and advertised for bids in the Invitation for Bids as:

**Contract No. 64D31
WHITESIDE County
Section D2 SPRING RS 2007-2
Route FAP 309
District 2 Construction Funds**

6.32 miles of 24 feet and variable width HMA resurfacing on U.S. Route 30 from French Creek to Emerson Road near Morrison.

2. The undersigned bidder will furnish all labor, material and equipment to complete the above described project in a good and workmanlike manner as provided in the contract documents provided by the Department of Transportation. This proposal will become part of the contract and the terms and conditions contained in the contract documents shall govern performance and payments.

RETURN WITH BID

- 3. **ASSURANCE OF EXAMINATION AND INSPECTION/WAIVER.** The undersigned further declares that he/she has carefully examined the proposal, plans, specifications, form of contract and contract bond, and special provisions, and that he/she has inspected in detail the site of the proposed work, and that he/she has familiarized themselves with all of the local conditions affecting the contract and the detailed requirements of construction, and understands that in making this proposal he/she waives all right to plead any misunderstanding regarding the same.
- 4. **EXECUTION OF CONTRACT AND CONTRACT BOND.** The undersigned further agrees to execute a contract for this work and present the same to the department within fifteen (15) days after the contract has been mailed to him/her. The undersigned further agrees that he/she and his/her surety will execute and present within fifteen (15) days after the contract has been mailed to him/her contract bond satisfactory to and in the form prescribed by the Department of Transportation, in the penal sum of the full amount of the contract, guaranteeing the faithful performance of the work in accordance with the terms of the contract.
- 5. **PROPOSAL GUARANTY.** Accompanying this proposal is either a bid bond on the department form, executed by a corporate surety company satisfactory to the department, or a proposal guaranty check consisting of a bank cashier's check or a properly certified check for not less than 5 per cent of the amount bid or for the amount specified in the following schedule:

<u>Amount of Bid</u>		<u>Proposal Guaranty</u>	<u>Amount of Bid</u>		<u>Proposal Guaranty</u>	
Up to	\$5,000	\$150	\$2,000,000	to	\$3,000,000	\$100,000
\$5,000	to \$10,000	\$300	\$3,000,000	to	\$5,000,000	\$150,000
\$10,000	to \$50,000	\$1,000	\$5,000,000	to	\$7,500,000	\$250,000
\$50,000	to \$100,000	\$3,000	\$7,500,000	to	\$10,000,000	\$400,000
\$100,000	to \$150,000	\$5,000	\$10,000,000	to	\$15,000,000	\$500,000
\$150,000	to \$250,000	\$7,500	\$15,000,000	to	\$20,000,000	\$600,000
\$250,000	to \$500,000	\$12,500	\$20,000,000	to	\$25,000,000	\$700,000
\$500,000	to \$1,000,000	\$25,000	\$25,000,000	to	\$30,000,000	\$800,000
\$1,000,000	to \$1,500,000	\$50,000	\$30,000,000	to	\$35,000,000	\$900,000
\$1,500,000	to \$2,000,000	\$75,000	over		\$35,000,000	\$1,000,000

Bank cashier's checks or properly certified checks accompanying proposals shall be made payable to the Treasurer, State of Illinois, when the state is awarding authority; the county treasurer, when a county is the awarding authority; or the city, village, or town treasurer, when a city, village, or town is the awarding authority.

If a combination bid is submitted, the proposal guaranties which accompany the individual proposals making up the combination will be considered as also covering the combination bid.

The amount of the proposal guaranty check is _____ \$(_____). If this proposal is accepted and the undersigned shall fail to execute a contract bond as required herein, it is hereby agreed that the amount of the proposal guaranty shall become the property of the State of Illinois, and shall be considered as payment of damages due to delay and other causes suffered by the State because of the failure to execute said contract and contract bond; otherwise, the bid bond shall become void or the proposal guaranty check shall be returned to the undersigned.

Attach Cashier's Check or Certified Check Here

In the event that one proposal guaranty check is intended to cover two or more proposals, the amount must be equal to the sum of the proposal guaranties which would be required for each individual proposal. If the guaranty check is placed in another proposal, state below where it may be found.

The proposal guaranty check will be found in the proposal for: Item _____
 Section No. _____
 County _____

Mark the proposal cover sheet as to the type of proposal guaranty submitted.

BD 354 (Rev. 11/2001)

RETURN WITH BID

6. **COMBINATION BIDS.** The undersigned further agrees that if awarded the contract for the sections contained in the following combination, he/she will perform the work in accordance with the requirements of each individual proposal comprising the combination bid specified in the schedule below, and that the combination bid shall be prorated against each section in proportion to the bid submitted for the same. If an error is found to exist in the gross sum bid for one or more of the individual sections included in a combination, the combination bid shall be corrected as provided in the specifications.

When a combination bid is submitted, the schedule below must be completed in each proposal comprising the combination.

If alternate bids are submitted for one or more of the sections comprising the combination, a combination bid must be submitted for each alternate.

Schedule of Combination Bids

Combination No.	Sections Included in Combination	Combination Bid	
		Dollars	Cents

7. **SCHEDULE OF PRICES.** The undersigned bidder submits herewith, in accordance with the rules and instructions, a schedule of prices for the items of work for which bids are sought. The unit prices bid are in U.S. dollars and cents, and all extensions and summations have been made. The bidder understands that the quantities appearing in the bid schedule are approximate and are provided for the purpose of obtaining a gross sum for the comparison of bids. If there is an error in the extension of the unit prices, the unit prices shall govern. Payment to the contractor awarded the contract will be made only for actual quantities of work performed and accepted or materials furnished according to the contract. The scheduled quantities of work to be done and materials to be furnished may be increased, decreased or omitted as provided elsewhere in the contract.

8. **CERTIFICATE OF AUTHORITY.** The undersigned bidder, if a business organized under the laws of another State, assures the Department that it will furnish a copy of its certificate of authority to do business in the State of Illinois with the return of the executed contract and bond. Failure to furnish the certificate within the time provided for execution of an awarded contract may be cause for cancellation of the award and forfeiture of the proposal guaranty to the State.

ILLINOIS DEPARTMENT OF TRANSPORTATION
 SCHEDULE OF PRICES
 CONTRACT
 NUMBER -

64D31

State Job # - C-92-100-07
 PPS NBR - 2-17110-0100
 County Name - WHITESIDE- -
 Code - 195 - -
 District - 2 - -
 Section Number - D2 SPRING RS 2007-2

Project Number

Route
 FAP 309

Item Number	Pay Item Description	Unit of Measure	Quantity	x	Unit Price	=	Total Price
Z0017100	DOWEL BARS	EACH	240.000				
Z0028415	GEOTECHNICAL REINF	SQ YD	1,188.000				
Z0028700	GRAN SUBGRADE REPL	CU YD	198.000				
Z0040315	PILOT CAR	DAY	5.000				
Z0075300	TIE BARS	EACH	13.000				
20200600	EXC & GR EX SHOULDER	UNIT	587.000				
35101400	AGG BASE CSE B	TON	541.000				
40600200	BIT MATLS PR CT	TON	60.000				
40600300	AGG PR CT	TON	146.000				
40600535	LEV BIND HM N70	TON	60.000				
40600637	LB MM IL-9.5FG N70	TON	6,749.000				
40600895	CONSTRUC TEST STRIP	EACH	1.000				
40600982	HMA SURF REM BUTT JT	SQ YD	1,150.000				
40600990	TEMPORARY RAMP	SQ YD	235.000				
40601005	HMA REPL OVER PATCH	TON	162.000				

ILLINOIS DEPARTMENT OF TRANSPORTATION
 SCHEDULE OF PRICES
 CONTRACT
 NUMBER - 64D31

State Job # - C-92-100-07
 PPS NBR - 2-17110-0100
 County Name - WHITESIDE - -
 Code - 195 - -
 District - 2 - -
 Section Number - D2 SPRING RS 2007-2

Project Number

Route
 FAP 309

Item Number	Pay Item Description	Unit of Measure	Quantity	x	Unit Price	=	Total Price
40603310	HMA SC "C" N50	TON	209.000				
40603340	HMA SC "D" N70	TON	8,158.000				
40800050	INCIDENTAL HMA SURF	TON	1,552.000				
42001200	PAVEMENT FABRIC	SQ YD	52.000				
44000158	HMA SURF REM 2 1/4	SQ YD	9,172.000				
44002210	HMA RM OV PATCH 2 1/2	SQ YD	1,159.000				
44200970	CL B PATCH T2 10	SQ YD	76.000				
44200974	CL B PATCH T3 10	SQ YD	20.000				
44200976	CL B PATCH T4 10	SQ YD	32.000				
44213200	SAW CUTS	FOOT	630.000				
48102100	AGG WEDGE SHLD TYPE B	TON	8,629.000				
67100100	MOBILIZATION	L SUM	1.000				
70100450	TRAF CONT-PROT 701201	L SUM	1.000				
70100460	TRAF CONT-PROT 701306	L SUM	1.000				
70100500	TRAF CONT-PROT 701326	L SUM	1.000				

ILLINOIS DEPARTMENT OF TRANSPORTATION
 SCHEDULE OF PRICES
 CONTRACT
 NUMBER -

64D31

State Job # - C-92-100-07
 PPS NBR - 2-17110-0100
 County Name - WHITESIDE- -
 Code - 195 - -
 District - 2 - -
 Section Number - D2 SPRING RS 2007-2

Project Number

Route
 FAP 309

Item Number	Pay Item Description	Unit of Measure	Quantity	x	Unit Price	=	Total Price
70300100	SHORT-TERM PAVT MKING	FOOT	10,288.000				
70301000	WORK ZONE PAVT MK REM	SQ FT	1,113.000				
78000100	THPL PVT MK LTR & SYM	SQ FT	140.000				
78000500	THPL PVT MK LINE 8	FOOT	745.000				
78000600	THPL PVT MK LINE 12	FOOT	104.000				
78000620	THPL PVT MK LINE 18	FOOT	36.000				
78000650	THPL PVT MK LINE 24	FOOT	50.000				
78001110	PAINT PVT MK LINE 4	FOOT	169,078.000				
78100100	RAISED REFL PAVT MKR	EACH	437.000				
78300200	RAISED REF PVT MK REM	EACH	412.000				

CONTRACT NUMBER

64D31

THIS IS THE TOTAL BID

\$ _____

NOTES:

1. Each PAY ITEM should have a UNIT PRICE and a TOTAL PRICE.
2. The UNIT PRICE shall govern if no TOTAL PRICE is shown or if there is a discrepancy between the product of the UNIT PRICE multiplied by the QUANTITY.
3. If a UNIT PRICE is omitted, the TOTAL PRICE will be divided by the QUANTITY in order to establish a UNIT PRICE.
4. A bid may be declared UNACCEPTABLE if neither a unit price nor a total price is shown.

RETURN WITH BID

STATE REQUIRED ETHICAL STANDARDS GOVERNING CONTRACT PROCUREMENT: ASSURANCES, CERTIFICATIONS AND DISCLOSURES

I. GENERAL

A. Article 50 of the Illinois Procurement Code establishes the duty of all State chief procurement officers, State purchasing officers, and their designees to maximize the value of the expenditure of public moneys in procuring goods, services, and contracts for the State of Illinois and to act in a manner that maintains the integrity and public trust of State government. In discharging this duty, they are charged by law to use all available information, reasonable efforts, and reasonable actions to protect, safeguard, and maintain the procurement process of the State of Illinois.

B. In order to comply with the provisions of Article 50 and to carry out the duty established therein, all bidders are to adhere to ethical standards established for the procurement process, and to make such assurances, disclosures and certifications required by law. By execution of the Proposal Signature Sheet, the bidder indicates that each of the mandated assurances has been read and understood, that each certification is made and understood, and that each disclosure requirement has been understood and completed.

C. In addition to all other remedies provided by law, failure to comply with any assurance, failure to make any disclosure or the making of a false certification shall be grounds for termination of the contract and the suspension or debarment of the bidder.

II. ASSURANCES

A. The assurances hereinafter made by the bidder are each a material representation of fact upon which reliance is placed should the Department enter into the contract with the bidder. The Department may terminate the contract if it is later determined that the bidder rendered a false or erroneous assurance, and the surety providing the performance bond shall be responsible for the completion of the contract.

B. Felons

1. The Illinois Procurement Code provides:

Section 50-10. Felons. Unless otherwise provided, no person or business convicted of a felony shall do business with the State of Illinois or any state agency from the date of conviction until 5 years after the date of completion of the sentence for that felony, unless no person held responsible by a prosecutorial office for the facts upon which the conviction was based continues to have any involvement with the business.

2. The bidder assures the Department that the award and execution of the contract would not cause a violation of Section 50-10.

C. Conflicts of Interest

1. The Illinois Procurement Code provides in pertinent part:

Section 50-13. Conflicts of Interest.

(a) Prohibition. It is unlawful for any person holding an elective office in this State, holding a seat in the General Assembly, or appointed to or employed in any of the offices or agencies of state government and who receives compensation for such employment in excess of 60% of the salary of the Governor of the State of Illinois, or who is an officer or employee of the Capital Development Board or the Illinois Toll Highway Authority, or who is the spouse or minor child of any such person to have or acquire any contract, or any direct pecuniary interest in any contract therein, whether for stationery, printing, paper, or any services, materials, or supplies, that will be wholly or partially satisfied by the payment of funds appropriated by the General Assembly of the State of Illinois or in any contract of the Capital Development Board or the Illinois Toll Highway authority.

(b) Interests. It is unlawful for any firm, partnership, association or corporation, in which any person listed in subsection (a) is entitled to receive (i) more than 7 1/2% of the total distributable income or (ii) an amount in excess of the salary of the Governor, to have or acquire any such contract or direct pecuniary interest therein.

(c) Combined interests. It is unlawful for any firm, partnership, association, or corporation, in which any person listed in subsection (a) together with his or her spouse or minor children is entitled to receive (i) more than 15%, in the aggregate, of the total distributable income or (ii) an amount in excess of 2 times the salary of the Governor, to have or acquire any such contract or direct pecuniary interest therein.

(d) Securities. Nothing in this Section invalidates the provisions of any bond or other security previously offered or to be offered for sale or sold by or for the State of Illinois.

(e) Prior interests. This Section does not affect the validity of any contract made between the State and an officer or employee of the State or member of the General Assembly, his or her spouse, minor child or any combination of those persons if that contract was in existence before his or her election or employment as an officer, member, or employee. The contract is voidable, however, if it cannot be completed within 365 days after the officer, member, or employee takes office or is employed.

The current salary of the Governor is \$150,700.00. Sixty percent of the salary is \$90,420.00.

RETURN WITH BID

2. The bidder assures the Department that the award and execution of the contract would not cause a violation of Section 50-13, or that an effective exemption has been issued by the Board of Ethics to any individual subject to the Section 50-13 prohibitions pursuant to the provisions of Section 50-20 of the Code and Executive Order Number 3 (1998). Information concerning the exemption process is available from the Department upon request.

D. Negotiations

1. The Illinois Procurement Code provides in pertinent part:

Section 50-15. Negotiations.

(a) It is unlawful for any person employed in or on a continual contractual relationship with any of the offices or agencies of State government to participate in contract negotiations on behalf of that office or agency with any firm, partnership, association, or corporation with whom that person has a contract for future employment or is negotiating concerning possible future employment.

2. The bidder assures the Department that the award and execution of the contract would not cause a violation of Section 50-15, and that the bidder has no knowledge of any facts relevant to the kinds of acts prohibited therein.

E. Inducements

1. The Illinois Procurement Code provides:

Section 50-25. Inducement. Any person who offers or pays any money or other valuable thing to any person to induce him or her not to bid for a State contract or as recompense for not having bid on a State contract is guilty of a Class 4 felony. Any person who accepts any money or other valuable thing for not bidding for a State contract or who withholds a bid in consideration of the promise for the payment of money or other valuable thing is guilty of a Class 4 felony.

2. The bidder assures the Department that the award and execution of the contract would not cause a violation of Section 50-25, and that the bidder has no knowledge of any facts relevant to the kinds of acts prohibited therein.

F. Revolving Door Prohibition

1. The Illinois Procurement Code provides:

Section 50-30. Revolving door prohibition. Chief procurement officers, associate procurement officers, State purchasing officers, their designees whose principal duties are directly related to State procurement, and executive officers confirmed by the Senate are expressly prohibited for a period of 2 years after terminating an affected position from engaging in any procurement activity relating to the State agency most recently employing them in an affected position for a period of at least 6 months. The prohibition includes, but is not limited to: lobbying the procurement process; specifying; bidding; proposing bid, proposal, or contract documents; on their own behalf or on behalf of any firm, partnership, association, or corporation. This Section applies only to persons who terminate an affected position on or after January 15, 1999.

2. The bidder assures the Department that the award and execution of the contract would not cause a violation of Section 50-30, and that the bidder has no knowledge of any facts relevant to the kinds of acts prohibited therein.

G. Reporting Anticompetitive Practices

1. The Illinois Procurement Code provides:

Section 50-40. Reporting anticompetitive practices. When, for any reason, any vendor, bidder, contractor, chief procurement officer, State purchasing officer, designee, elected official, or State employee suspects collusion or other anticompetitive practice among any bidders, offerors, contractors, proposers, or employees of the State, a notice of the relevant facts shall be transmitted to the Attorney General and the chief procurement officer.

2. The bidder assures the Department that it has not failed to report any relevant facts concerning the practices addressed in Section 50-40 which may involve the contract for which the bid is submitted.

H. Confidentiality

1. The Illinois Procurement Code provides:

Section 50-45. Confidentiality. Any chief procurement officer, State purchasing officer, designee, or executive officer who willfully uses or allows the use of specifications, competitive bid documents, proprietary competitive information, proposals, contracts, or selection information to compromise the fairness or integrity of the procurement, bidding, or contract process shall be subject to immediate dismissal, regardless of the Personnel code, any contract, or any collective bargaining agreement, and may in addition be subject to criminal prosecution.

2. The bidder assures the Department that it has no knowledge of any fact relevant to the practices addressed in Section 50-45 which may involve the contract for which the bid is submitted.

RETURN WITH BID

I. Insider Information

1. The Illinois Procurement Act provides:

Section 50-50. Insider information. It is unlawful for any current or former elected or appointed State official or State employee to knowingly use confidential information available only by virtue of that office or employment for actual or anticipated gain for themselves or another person.

2. The bidder assures the Department that it has no knowledge of any facts relevant to the practices addressed in Section 50-50 which may involve the contract for which the bid is submitted.

III. CERTIFICATIONS

A. The certifications hereinafter made by the bidder are each a material representation of fact upon which reliance is placed should the Department enter into the contract with the bidder. The Department may terminate the contract if it is later determined that the bidder rendered a false or erroneous certification, and the surety providing the performance bond shall be responsible for completion of the contract.

B. Bribery

1. The Illinois Procurement Code provides:

Section 50-5. Bribery.

(a) Prohibition. No person or business shall be awarded a contract or subcontract under this Code who:

(1) has been convicted under the laws of Illinois or any other state of bribery or attempting to bribe an officer or employee of the State of Illinois or any other state in that officer's or employee's official capacity; or

(2) has made an admission of guilt of that conduct that is a matter of record but has not been prosecuted for that conduct.

(b) Businesses. No business shall be barred from contracting with any unit of State or local government as a result of a conviction under this Section of any employee or agent of the business if the employee or agent is no longer employed by the business and:

(1) the business has been finally adjudicated not guilty; or

(2) the business demonstrates to the governmental entity with which it seeks to contract, and that entity finds that the commission of the offense was not authorized, requested, commanded, or performed by a director, officer, or high managerial agent on behalf of the business as provided in paragraph (2) of subsection (a) of Section 5-4 of the Criminal Code of 1961.

(c) Conduct on behalf of business. For purposes of this Section, when an official, agent, or employee of a business committed the bribery or attempted bribery on behalf of the business and in accordance with the direction or authorization of a responsible official of the business, the business shall be chargeable with the conduct.

(d) Certification. Every bid submitted to and contract executed by the State shall contain a certification by the contractor that the contractor is not barred from being awarded a contract or subcontract under this Section. A contractor who makes a false statement, material to the certification, commits a Class 3 felony.

2. The bidder certifies that it is not barred from being awarded a contract under Section 50.5.

C. Educational Loan

1. Section 3 of the Educational Loan Default Act provides:

§ 3. No State agency shall contract with an individual for goods or services if that individual is in default, as defined in Section 2 of this Act, on an educational loan. Any contract used by any State agency shall include a statement certifying that the individual is not in default on an educational loan as provided in this Section.

2. The bidder, if an individual as opposed to a corporation, partnership or other form of business organization, certifies that the bidder is not in default on an educational loan as provided in Section 3 of the Act.

D. Bid-Rigging/Bid Rotating

1. Section 33E-11 of the Criminal Code of 1961 provides:

§ 33E-11. (a) Every bid submitted to and public contract executed pursuant to such bid by the State or a unit of local government shall contain a certification by the prime contractor that the prime contractor is not barred from contracting with any unit of State or local government as a result of a violation of either Section 33E-3 or 33E-4 of this Article. The State and units of local government shall provide the appropriate forms for such certification.

RETURN WITH BID

(b) A contractor who makes a false statement, material to the certification, commits a Class 3 felony.

A violation of Section 33E-3 would be represented by a conviction of the crime of bid-rigging which, in addition to Class 3 felony sentencing, provides that any person convicted of this offense or any similar offense of any state or the United States which contains the same elements as this offense shall be barred for 5 years from the date of conviction from contracting with any unit of State or local government. No corporation shall be barred from contracting with any unit of State or local government as a result of a conviction under this Section of any employee or agent of such corporation if the employee so convicted is no longer employed by the corporation and: (1) it has been finally adjudicated not guilty or (2) if it demonstrates to the governmental entity with which it seeks to contract and that entity finds that the commission of the offense was neither authorized, requested, commanded, nor performed by a director, officer or a high managerial agent in behalf of the corporation.

A violation of Section 33E-4 would be represented by a conviction of the crime of bid-rotating which, in addition to Class 2 felony sentencing, provides that any person convicted of this offense or any similar offense of any state or the United States which contains the same elements as this offense shall be permanently barred from contracting with any unit of State or local government. No corporation shall be barred from contracting with any unit of State or local government as a result of a conviction under this Section of any employee or agent of such corporation if the employee so convicted is no longer employed by the corporation and: (1) it has been finally adjudicated not guilty or (2) if it demonstrates to the governmental entity with which it seeks to contract and that entity finds that the commission of the offense was neither authorized, requested, commanded, nor performed by a director, officer or a high managerial agent in behalf of the corporation.

2. The bidder certifies that it is not barred from contracting with the Department by reason of a violation of either Section 33E-3 or Section 33E-4.

E. International Anti-Boycott

1. Section 5 of the International Anti-Boycott Certification Act provides:

§ 5. State contracts. Every contract entered into by the State of Illinois for the manufacture, furnishing, or purchasing of supplies, material, or equipment or for the furnishing of work, labor, or services, in an amount exceeding the threshold for small purchases according to the purchasing laws of this State or \$10,000.00, whichever is less, shall contain certification, as a material condition of the contract, by which the contractor agrees that neither the contractor nor any substantially-owned affiliated company is participating or shall participate in an international boycott in violation of the provisions of the U.S. Export Administration Act of 1979 or the regulations of the U.S. Department of Commerce promulgated under that Act.

2. The bidder makes the certification set forth in Section 5 of the Act.

F. Drug Free Workplace

1. The Illinois "Drug Free Workplace Act" applies to this contract and it is necessary to comply with the provisions of the "Act" if the contractor is a corporation, partnership, or other entity (including a sole proprietorship) which has 25 or more employees.

2. The bidder certifies that if awarded a contract in excess of \$5,000 it will provide a drug free workplace by:

(a) Publishing a statement notifying employees that the unlawful manufacture, distribution, dispensation, possession or use of a controlled substance, including cannabis, is prohibited in the contractor's workplace; specifying the actions that will be taken against employees for violations of such prohibition; and notifying the employee that, as a condition of employment on such contract, the employee shall abide by the terms of the statement, and notify the employer of any criminal drug statute conviction for a violation occurring in the workplace no later than five (5) days after such conviction.

(b) Establishing a drug free awareness program to inform employees about the dangers of drug abuse in the workplace; the contractor's policy of maintaining a drug free workplace; any available drug counseling, rehabilitation, and employee assistance programs; and the penalties that may be imposed upon employees for drug violations.

(c) Providing a copy of the statement required by subparagraph (1) to each employee engaged in the performance of the contract and to post the statement in a prominent place in the workplace.

(d) Notifying the Department within ten (10) days after receiving notice from an employee or otherwise receiving actual notice of the conviction of an employee for a violation of any criminal drug statute occurring in the workplace.

(e) Imposing or requiring, within 30 days after receiving notice from an employee of a conviction or actual notice of such a conviction, an appropriate personnel action, up to and including termination, or the satisfactory participation in a drug abuse assistance or rehabilitation program approved by a federal, state or local health, law enforcement or other appropriate agency.

(f) Assisting employees in selecting a course of action in the event drug counseling, treatment, and rehabilitation is required and indicating that a trained referral team is in place.

(g) Making a good faith effort to continue to maintain a drug free workplace through implementation of the actions and efforts stated in this certification.

G. Debt Delinquency

1. The Illinois Procurement Code provides:

Section 50-11 and 50-12. Debt Delinquency.

The contractor or bidder certifies that it, or any affiliate, is not barred from being awarded a contract under 30 ILCS 500. Section 50-11 prohibits a person from entering into a contract with a State agency if it knows or should know that it, or any affiliate, is delinquent in the payment of any debt to the State as defined by the Debt Collection Board. Section 50-12 prohibits a person from entering into a contract with a State agency if it, or any affiliate, has failed to collect and remit Illinois Use Tax on all sales of tangible personal property into the State of Illinois in accordance with the provisions of the Illinois Use Tax Act. The contractor further acknowledges that the contracting State agency may declare the contract void if this certification is false or if the contractor, or any affiliate, is determined to be delinquent in the payment of any debt to the State during the term of the contract.

H. Sarbanes-Oxley Act of 2002

1. The Illinois Procurement Code provides:

Section 50-60(c).

The contractor certifies in accordance with 30 ILCS 500/50-10.5 that no officer, director, partner or other managerial agent of the contracting business has been convicted of a felony under the Sarbanes-Oxley Act of 2002 or a Class 3 or Class 2 felony under the Illinois Securities Law of 1953 for a period of five years prior to the date of the bid or contract. The contractor acknowledges that the contracting agency shall declare the contract void if this certification is false.

I. Addenda

The contractor or bidder certifies that all relevant addenda have been incorporated in to this contract. Failure to do so may cause the bid to be declared unacceptable.

J. Section 42 of the Environmental Protection Act

The contractor certifies in accordance with 30 ILCS 500/50-12 that the bidder or contractor is not barred from being awarded a contract under this Section which prohibits the bidding on or entering into contracts with the State of Illinois or a State agency by a person or business found by a court or the Pollution Control Board to have committed a willful or knowing violation of Section 42 of the Environmental Protection Act for a period of five years from the date of the order. The contractor acknowledges that the contracting agency may declare the contract void if this certification is false.

K. Apprenticeship and Training Certification (Does not apply to federal aid projects)

In accordance with the provisions of Section 30-22 (6) of the Illinois Procurement Code, the bidder certifies that it is a participant, either as an individual or as part of a group program, in the approved apprenticeship and training programs applicable to each type of work or craft that the bidder will perform with its own forces. The bidder further certifies for work that will be performed by subcontract that each of its subcontractors submitted for approval either (a) is, at the time of such bid, participating in an approved, applicable apprenticeship and training program; or (b) will, prior to commencement of performance of work pursuant to this contract, begin participation in an approved apprenticeship and training program applicable to the work of the subcontract. The Department, at any time before or after award, may require the production of a copy of each applicable Certificate of Registration issued by the United States Department of Labor evidencing such participation by the contractor and any or all of its subcontractors. Applicable apprenticeship and training programs are those that have been approved and registered with the United States Department of Labor. The bidder shall list in the space below, the official name of the program sponsor holding the Certificate of Registration for all of the types of work or crafts in which the bidder is a participant and that will be performed with the bidder's forces. Types of work or craft work that will be subcontracted shall be included and listed as subcontract work. The list shall also indicate any type of work or craft job category that does not have an applicable apprenticeship or training program. **The bidder is responsible for making a complete report and shall make certain that each type of work or craft job category that will be utilized on the project as reported on the Construction Employee Workforce Projection (Form BC-1256) and returned with the bid is accounted for and listed.**

The requirements of this certification and disclosure are a material part of the contract, and the contractor shall require this certification provision to be included in all approved subcontracts. In order to fulfill this requirement, it shall not be necessary that an applicable program sponsor be currently taking or that it will take applications for apprenticeship, training or employment during the performance of the work of this contract.

L. Executive Order Number 1 (2007) Regarding Lobbying on Government Procurements

The bidder hereby warrants and certifies that they have complied and will comply with the requirements set forth in this Order. The requirements of this warrant and certification are a material part of the contract, and the contractor shall require this warrant and certification provision to be included in all approved subcontracts.

TO BE RETURNED WITH BID

IV. DISCLOSURES

A. The disclosures hereinafter made by the bidder are each a material representation of fact upon which reliance is placed should the Department enter into the contract with the bidder. The Department may terminate the contract if it is later determined that the bidder rendered a false or erroneous disclosure, and the surety providing the performance bond shall be responsible for completion of the contract.

B. Financial Interests and Conflicts of Interest

1. Section 50-35 of the Illinois Procurement Code provides that all bids of more than \$10,000 shall be accompanied by disclosure of the financial interests of the bidder. This disclosed information for the successful bidder, will be maintained as public information subject to release by request pursuant to the Freedom of Information Act.

The financial interests to be disclosed shall include ownership or distributive income share that is in excess of 5%, or an amount greater than 60% of the annual salary of the Governor, of the bidding entity or its parent entity, whichever is less, unless the contractor or bidder is a publicly traded entity subject to Federal 10K reporting, in which case it may submit its 10K disclosure in place of the prescribed disclosure. If a bidder is a privately held entity that is exempt from Federal 10K reporting, but has more than 400 shareholders, it may submit the information that Federal 10K companies are required to report, and list the names of any person or entity holding any ownership share that is in excess of 5%. The disclosure shall include the names, addresses, and dollar or proportionate share of ownership of each person making the disclosure, their instrument of ownership or beneficial relationship, and notice of any potential conflict of interest resulting from the current ownership or beneficial interest of each person making the disclosure having any of the relationships identified in Section 50-35 and on the disclosure form.

In addition, all disclosures shall indicate any other current or pending contracts, proposals, leases, or other ongoing procurement relationships the bidding entity has with any other unit of state government and shall clearly identify the unit and the contract, proposal, lease, or other relationship.

2. Disclosure Forms. Disclosure Form A is attached for use concerning the individuals meeting the above ownership or distributive share requirements. Subject individuals should be covered each by one form. In addition, a second form (Disclosure Form B) provides for the disclosure of current or pending procurement relationships with other (non-IDOT) state agencies. **The forms must be included with each bid or incorporated by reference.**

C. Disclosure Form Instructions

Form A: For bidders that have previously submitted the information requested in Form A

The Department has retained the Form A disclosures submitted by all bidders responding to these requirements for the April 24, 1998 or any subsequent letting conducted by the Department. The bidder has the option of submitting the information again or the bidder may sign the following certification statement indicating that the information previously submitted by the bidder is, as of the date of signature, current and accurate. The Certification must be signed and dated by a person who is authorized to execute contracts for the bidding company. Before signing this certification, the bidder should carefully review its prior submissions to ensure the Certification is correct. If the Bidder signs the Certification, the Bidder should proceed to Form B instructions.

CERTIFICATION STATEMENT

I have determined that the Form A disclosure information previously submitted is current and accurate, and all forms are hereby incorporated by reference in this bid. Any necessary additional forms or amendments to previously submitted forms are attached to this bid.

(Bidding Company)

Name of Authorized Representative (type or print)

Title of Authorized Representative (type or print)

Signature of Authorized Representative

Date

Form A: For bidders who have NOT previously submitted the information requested in Form A

If the bidder is a publicly traded entity subject to Federal 10K reporting, the 10K Report may be submitted to meet the requirements of Form A. If a bidder is a privately held entity that is exempt from Federal 10K reporting, but has more than 400 shareholders, it may submit the information that Federal 10K companies are required to report, and list the names of any person or entity holding any ownership share that is in excess of 5%. If a bidder is not subject to Federal 10K reporting, the bidder must determine if any individuals are required by law to complete a financial disclosure form. To do this, the bidder should answer each of the following questions. A "YES" answer indicates Form A must be completed. If the answer to each of the following questions is "NO", then the NOT APPLICABLE STATEMENT on the second page of Form A must be signed and dated by a person that is authorized to execute contracts for the bidding company. Note: These questions are for assistance only and are not required to be completed.

1. Does anyone in your organization have a direct or beneficial ownership share of greater than 5% of the bidding entity or parent entity? YES ___ NO ___
2. Does anyone in your organization have a direct or beneficial ownership share of less than 5%, but which has a value greater than \$90,420.00? YES ___ NO ___
3. Does anyone in your organization receive more than \$90,420.00 of the bidding entity's or parent entity's distributive income? (Note: Distributive income is, for these purposes, any type of distribution of profits. An annual salary is not distributive income.) YES ___ NO ___
4. Does anyone in your organization receive greater than 5% of the bidding entity's or parent entity's total distributive income, but which is less than \$90,420.00? YES ___ NO ___

(Note: Only one set of forms needs to be completed per person per bid even if a specific individual would require a yes answer to more than one question.)

A "YES" answer to any of these questions requires the completion of Form A. The bidder must determine each individual in the bidding entity or the bidding entity's parent company that would cause the questions to be answered "Yes". Each form must be signed and dated by a person that is authorized to execute contracts for your organization. **Photocopied or stamped signatures are not acceptable.** The person signing can be, but does not have to be, the person for which the form is being completed. The bidder is responsible for the accuracy of any information provided.

If the answer to each of the above questions is "NO", then the NOT APPLICABLE STATEMENT on page 2 of Form A must be signed and dated by a person that is authorized to execute contracts for your company.

Form B: Identifying Other Contracts & Procurement Related Information Disclosure Form B must be completed for each bid submitted by the bidding entity. It must be signed by an individual who is authorized to execute contracts for the bidding entity. *Note: Signing the NOT APPLICABLE STATEMENT on Form A does not allow the bidder to ignore Form B. Form B must be completed, signed and dated or the bidder may be considered nonresponsive and the bid will not be accepted.*

The Bidder shall identify, by checking Yes or No on Form B, whether it has any pending contracts (including leases), bids, proposals, or other ongoing procurement relationship with any other (non-IDOT) State of Illinois agency. If "No" is checked, the bidder only needs to complete the signature box on the bottom of Form B. If "Yes" is checked, the bidder must do one of the following:

Option I: If the bidder did not submit an Affidavit of Availability to obtain authorization to bid, the bidder must list all non-IDOT State of Illinois agency pending contracts, leases, bids, proposals, and other ongoing procurement relationships. These items may be listed on Form B or on an attached sheet(s). Do not include IDOT contracts. Contracts with cities, counties, villages, etc. are not considered State of Illinois agency contracts and are not to be included. Contracts with other State of Illinois agencies such as the Department of Natural Resources or the Capital Development Board must be included. Bidders who submit Affidavits of Availability are suggested to use Option II.

Option II: If the bidder is required and has submitted an Affidavit of Availability in order to obtain authorization to bid, the bidder may write or type "See Affidavit of Availability" which indicates that the Affidavit of Availability is incorporated by reference and includes all non-IDOT State of Illinois agency pending contracts, leases, bids, proposals, and other ongoing procurement relationships. For any contracts that are not covered by the Affidavit of Availability, the bidder must identify them on Form B or on an attached sheet(s). These might be such things as leases.

D. Bidders Submitting More Than One Bid

Bidders submitting multiple bids may submit one set of forms consisting of all required Form A disclosures and one Form B for use with all bids. Please indicate in the space provided below the bid item that contains the original disclosure forms and the bid items which incorporate the forms by reference.

- The bid submitted for letting item _____ contains the Form A disclosures or Certification Statement and the Form B disclosures. The following letting items incorporate the said forms by reference:

**ILLINOIS DEPARTMENT
OF TRANSPORTATION**

**Form A
Financial Information &
Potential Conflicts of Interest
Disclosure**

Contractor Name		
Legal Address		
City, State, Zip		
Telephone Number	Email Address	Fax Number (if available)

Disclosure of the information contained in this Form is required by the Section 50-35 of the Illinois Procurement Code (30 ILCS 500). Vendors desiring to enter into a contract with the State of Illinois must disclose the financial information and potential conflict of interest information as specified in this Disclosure Form. This information shall become part of the publicly available contract file. This Form A must be completed for bids in excess of \$10,000, and for all open-ended contracts. **A publicly traded company may submit a 10K disclosure (or equivalent if applicable) in satisfaction of the requirements set forth in Form A. See Disclosure Form Instructions.**

DISCLOSURE OF FINANCIAL INFORMATION

1. Disclosure of Financial Information. The individual named below has an interest in the BIDDER (or its parent) in terms of ownership or distributive income share in excess of 5%, or an interest which has a value of more than \$90,420.00 (60% of the Governor's salary as of 7/1/01). **(Make copies of this form as necessary and attach a separate Disclosure Form A for each individual meeting these requirements)**

FOR INDIVIDUAL (type or print information)

NAME: _____

ADDRESS _____

Type of ownership/distributable income share:

stock _____ sole proprietorship _____ Partnership _____ other: (explain on separate sheet):
% or \$ value of ownership/distributable income share: _____

2. Disclosure of Potential Conflicts of Interest. Check "Yes" or "No" to indicate which, if any, of the following potential conflict of interest relationships apply. If the answer to any question is "Yes", please attach additional pages and describe.

(a) State employment, currently or in the previous 3 years, including contractual employment of services. Yes ___ No ___

If your answer is yes, please answer each of the following questions.

1. Are you currently an officer or employee of either the Capitol Development Board or the Illinois Toll Highway Authority? Yes ___ No ___

2. Are you currently appointed to or employed by any agency of the State of Illinois? If you are currently appointed to or employed by any agency of the State of Illinois, and your annual salary exceeds \$90,420.00, (60% of the Governor's salary as of 7/1/01) provide the name the State agency for which you are employed and your annual salary. _____

RETURN WITH BID/OFFER

- 3. If you are currently appointed to or employed by any agency of the State of Illinois, and your annual salary exceeds \$90,420.00, (60% of the Governor's salary as of 7/1/01) are you entitled to receive (i) more than 7 1/2% of the total distributable income of your firm, partnership, association or corporation, or (ii) an amount in excess of the salary of the Governor? Yes ___ No ___
- 4. If you are currently appointed to or employed by any agency of the State of Illinois, and your annual salary exceeds \$90,420.00, (60% of the Governor's salary as of 7/1/01) are you and your spouse or minor children entitled to receive (i) more than 15 % in the aggregate of the total distributable income of your firm, partnership, association or corporation, or (ii) an amount in excess of 2 times the salary of the Governor? Yes ___ No ___

(b) State employment of spouse, father, mother, son, or daughter, including contractual employment services in the previous 2 years.

Yes ___ No ___

If your answer is yes, please answer each of the following questions.

- 1. Is your spouse or any minor children currently an officer or employee of the Capitol Development Board or the Illinois Toll Highway Authority? Yes ___ No ___
- 2. Is your spouse or any minor children currently appointed to or employed by any agency of the State of Illinois? If your spouse or minor children is/are currently appointed to or employed by any agency of the State of Illinois, and his/her annual salary exceeds \$90,420.00, (60 % of the Governor's salary as of 7/1/01) provide the name of your spouse and/or minor children, the name of the State agency for which he/she is employed and his/her annual salary. _____

- 3. If your spouse or any minor children is/are currently appointed to or employed by any agency of the State of Illinois, and his/her annual salary exceeds \$90,420.00, (60% of the salary of the Governor as of 7/1/01) are you entitled to receive (i) more then 71/2% of the total distributable income of your firm, partnership, association or corporation, or (ii) an amount in excess of the salary of the Governor? Yes ___ No ___
- 4. If your spouse or any minor children are currently appointed to or employed by any agency of the State of Illinois, and his/her annual salary exceeds \$90,420.00, (60% of the Governor's salary as of 7/1/01) are you and your spouse or minor children entitled to receive (i) more than 15 % in the aggregate of the total distributable income of your firm, partnership, association or corporation, or (ii) an amount in excess of 2 times the salary of the Governor? Yes ___ No ___

(c) Elective status; the holding of elective office of the State of Illinois, the government of the United States, any unit of local government authorized by the Constitution of the State of Illinois or the statutes of the State of Illinois currently or in the previous 3 years.

Yes ___ No ___

(d) Relationship to anyone holding elective office currently or in the previous 2 years; spouse, father, mother, son, or daughter.

Yes ___ No ___

(e) Appointive office; the holding of any appointive government office of the State of Illinois, the United States of America, or any unit of local government authorized by the Constitution of the State of Illinois or the statutes of the State of Illinois, which office entitles the holder to compensation in excess of the expenses incurred in the discharge of that office currently or in the previous 3 years.

Yes ___ No ___

(f) Relationship to anyone holding appointive office currently or in the previous 2 years; spouse, father, mother, son, or daughter.

Yes ___ No ___

(g) Employment, currently or in the previous 3 years, as or by any registered lobbyist of the State government.

Yes ___ No ___

RETURN WITH BID/OFFER

(h) Relationship to anyone who is or was a registered lobbyist in the previous 2 years; spouse, father, mother, son, or daughter. Yes ___ No ___

(i) Compensated employment, currently or in the previous 3 years, by any registered election or reelection committee registered with the Secretary of State or any county clerk of the State of Illinois, or any political action committee registered with either the Secretary of State or the Federal Board of Elections. Yes ___ No ___

(j) Relationship to anyone; spouse, father, mother, son, or daughter; who was a compensated employee in the last 2 years by any registered election or re-election committee registered with the Secretary of State or any county clerk of the State of Illinois, or any political action committee registered with either the Secretary of State or the Federal Board of Elections. Yes ___ No ___

APPLICABLE STATEMENT

This Disclosure Form A is submitted on behalf of the INDIVIDUAL named on previous page.

Completed by: _____
Name of Authorized Representative (type or print)

Completed by: _____
Title of Authorized Representative (type or print)

Completed by: _____ Date _____
Signature of Individual or Authorized Representative

NOT APPLICABLE STATEMENT

I have determined that no individuals associated with this organization meet the criteria that would require the completion of this Form A.

This Disclosure Form A is submitted on behalf of the CONTRACTOR listed on the previous page.

Name of Authorized Representative (type or print)

Title of Authorized Representative (type or print)

Signature of Authorized Representative Date _____

RETURN WITH BID/OFFER

ILLINOIS DEPARTMENT
OF TRANSPORTATION

Form B
Other Contracts &
Procurement Related Information
Disclosure

Contractor Name		
Legal Address		
City, State, Zip		
Telephone Number	Email Address	Fax Number (if available)

Disclosure of the information contained in this Form is required by the Section 50-35 of the Illinois Procurement Act (30 ILCS 500). This information shall become part of the publicly available contract file. This Form B must be completed for bids in excess of \$10,000, and for all open-ended contracts.

DISCLOSURE OF OTHER CONTRACTS AND PROCUREMENT RELATED INFORMATION

1. Identifying Other Contracts & Procurement Related Information. The BIDDER shall identify whether it has any pending contracts (including leases), bids, proposals, or other ongoing procurement relationship with any other State of Illinois agency: Yes ___ No ___

If **“No” is checked**, the bidder only needs to complete the signature box on the bottom of this page.

2. If “Yes” is checked. Identify each such relationship by showing State of Illinois agency name and other descriptive information such as bid or project number (attach additional pages as necessary). SEE DISCLOSURE FORM INSTRUCTIONS:

THE FOLLOWING STATEMENT MUST BE SIGNED

Name of Authorized Representative (type or print)	

Title of Authorized Representative (type or print)	
_____	_____
Signature of Authorized Representative	Date

RETURN WITH BID

SPECIAL NOTICE TO CONTRACTORS

The following requirements of the Illinois Department of Human Rights' Rules and Regulations are applicable to bidders on all construction contracts advertised by the Illinois Department of Transportation:

CONSTRUCTION EMPLOYEE UTILIZATION PROJECTION

- (a) All bidders on construction contracts shall complete and submit, along with and as part of their bids, a Bidder's Employee Utilization Form (Form BC-1256) setting forth a projection and breakdown of the total workforce intended to be hired and/or allocated to such contract work by the bidder including a projection of minority and female employee utilization in all job classifications on the contract project.
- (b) The Department of Transportation shall review the Employee Utilization Form, and workforce projections contained therein, of the contract awardee to determine if such projections reflect an underutilization of minority persons and/or women in any job classification in accordance with the Equal Employment Opportunity Clause and Section 7.2 of the Illinois Department of Human Rights' Rules and Regulations for Public Contracts adopted as amended on September 17, 1980. If it is determined that the contract awardee's projections reflect an underutilization of minority persons and/or women in any job classification, it shall be advised in writing of the manner in which it is underutilizing and such awardee shall be considered to be in breach of the contract unless, prior to commencement of work on the contract project, it submits revised satisfactory projections or an acceptable written affirmative action plan to correct such underutilization including a specific timetable geared to the completion stages of the contract.
- (c) The Department of Transportation shall provide to the Department of Human Rights a copy of the contract awardee's Employee Utilization Form, a copy of any required written affirmative action plan, and any written correspondence related thereto. The Department of Human Rights may review and revise any action taken by the Department of Transportation with respect to these requirements.



Contract No. 64D31
 WHITESIDE County
 Section D2 SPRING RS 2007-2
 Route FAP 309
 District 2 Construction Funds

PART I. IDENTIFICATION

Dept. Human Rights # _____ Duration of Project: _____

Name of Bidder: _____

PART II. WORKFORCE PROJECTION

A. The undersigned bidder has analyzed minority group and female populations, unemployment rates and availability of workers for the location in which this contract work is to be performed, and for the locations from which the bidder recruits employees, and hereby submits the following workforce projection including a projection for minority and female employee utilization in all job categories in the workforce to be allocated to this contract:

TABLE A

TOTAL Workforce Projection for Contract												
JOB CATEGORIES	TOTAL EMPLOYEES		MINORITY EMPLOYEES						TRAINEES			
			BLACK		HISPANIC		*OTHER MINOR.		APPRENTICES		ON THE JOB TRAINEES	
	M	F	M	F	M	F	M	F	M	F	M	F
OFFICIALS (MANAGERS)												
SUPERVISORS												
FOREMEN												
CLERICAL EQUIPMENT OPERATORS												
MECHANICS												
TRUCK DRIVERS												
IRONWORKERS												
CARPENTERS												
CEMENT MASONS												
ELECTRICIANS												
PIPEFITTERS, PLUMBERS												
PAINTERS												
LABORERS, SEMI-SKILLED												
LABORERS, UNSKILLED												
TOTAL												

TABLE B

CURRENT EMPLOYEES TO BE ASSIGNED TO CONTRACT			
TOTAL EMPLOYEES		MINORITY EMPLOYEES	
M	F	M	F

TABLE C

TOTAL Training Projection for Contract								
EMPLOYEES IN TRAINING	TOTAL EMPLOYEES		BLACK		HISPANIC		*OTHER MINOR.	
	M	F	M	F	M	F	M	F
APPRENTICES								
ON THE JOB TRAINEES								

FOR DEPARTMENT USE ONLY

*Other minorities are defined as Asians (A) or Native Americans (N).
 Please specify race of each employee shown in Other Minorities column.
Note: See instructions on the next page

RETURN WITH BID

**Contract No. 64D31
WHITESIDE County
Section D2 SPRING RS 2007-2
Route FAP 309
District 2 Construction Funds**

PART II. WORKFORCE PROJECTION - continued

B. Included in "Total Employees" under Table A is the total number of **new hires** that would be employed in the event the undersigned bidder is awarded this contract.

The undersigned bidder projects that: (number) _____ new hires would be recruited from the area in which the contract project is located; and/or (number) _____ new hires would be recruited from the area in which the bidder's principal office or base of operation is located.

C. Included in "Total Employees" under Table A is a projection of numbers of persons to be employed directly by the undersigned bidder as well as a projection of numbers of persons to be employed by subcontractors.

The undersigned bidder estimates that (number) _____ persons will be directly employed by the prime contractor and that (number) _____ persons will be employed by subcontractors.

PART III. AFFIRMATIVE ACTION PLAN

A. The undersigned bidder understands and agrees that in the event the foregoing minority and female employee utilization projection included under **PART II** is determined to be an underutilization of minority persons or women in any job category, and in the event that the undersigned bidder is awarded this contract, he/she will, prior to commencement of work, develop and submit a written Affirmative Action Plan including a specific timetable (geared to the completion stages of the contract) whereby deficiencies in minority and/or female employee utilization are corrected. Such Affirmative Action Plan will be subject to approval by the contracting agency and the **Department of Human Rights**.

B. The undersigned bidder understands and agrees that the minority and female employee utilization projection submitted herein, and the goals and timetable included under an Affirmative Action Plan if required, are deemed to be part of the contract specifications.

Company _____ Telephone Number _____

Address _____

NOTICE REGARDING SIGNATURE

The Bidder's signature on the Proposal Signature Sheet will constitute the signing of this form. The following signature block needs to be completed only if revisions are required.

Signature: _____ Title: _____ Date: _____

- Instructions: All tables must include subcontractor personnel in addition to prime contractor personnel.
- Table A - Include both the number of employees that would be hired to perform the contract work and the total number currently employed (Table B) that will be allocated to contract work, and include all apprentices and on-the-job trainees. The "Total Employees" column should include all employees including all minorities, apprentices and on-the-job trainees to be employed on the contract work.
- Table B - Include all employees currently employed that will be allocated to the contract work including any apprentices and on-the-job trainees currently employed.
- Table C - Indicate the racial breakdown of the total apprentices and on-the-job trainees shown in Table A.

RETURN WITH BID

**Contract No. 64D31
WHITESIDE County
Section D2 SPRING RS 2007-2
Route FAP 309
District 2 Construction Funds**

PROPOSAL SIGNATURE SHEET

The undersigned bidder hereby makes and submits this bid on the subject Proposal, thereby assuring the Department that all requirements of the Invitation for Bids and rules of the Department have been met, that there is no misunderstanding of the requirements of paragraph 3 of this Proposal, and that the contract will be executed in accordance with the rules of the Department if an award is made on this bid.

Firm Name _____
(IF AN INDIVIDUAL) Signature of Owner _____
Business Address _____

Firm Name _____
By _____
(IF A CO-PARTNERSHIP) Business Address _____

Name and Address of All Members of the Firm:

Corporate Name _____
By _____
Signature of Authorized Representative

Typed or printed name and title of Authorized Representative
(IF A CORPORATION) Attest _____
Signature
(IF A JOINT VENTURE, USE THIS SECTION
FOR THE MANAGING PARTY AND THE
SECOND PARTY SHOULD SIGN BELOW) Business Address _____

Corporate Name _____
By _____
Signature of Authorized Representative

Typed or printed name and title of Authorized Representative
(IF A JOINT VENTURE) Attest _____
Signature
Business Address _____

If more than two parties are in the joint venture, please attach an additional signature sheet.



RETURN WITH BID

Division of Highways
Proposal Bid Bond
(Effective November 1, 1992)

Item No.
Letting Date

KNOW ALL MEN BY THESE PRESENTS, That We
as PRINCIPAL, and

held jointly, severally and firmly bound unto the STATE OF ILLINOIS in the penal sum of 5 percent of the total bid price, or for the amount specified in Article 102.09 of the "Standard Specifications for Road and Bridge Construction" in effect on the date of invitation for bids, whichever is the lesser sum, well and truly to be paid unto said STATE OF ILLINOIS, for the payment of which we bind ourselves, our heirs, executors, administrators, successors and assigns.

THE CONDITION OF THE FOREGOING OBLIGATION IS SUCH, That Whereas, the PRINCIPAL has submitted a bid proposal to the STATE OF ILLINOIS, acting through the Department of Transportation, for the improvement designated by the Transportation Bulletin Item Number and Letting Date indicated above.

NOW, THEREFORE, if the Department shall accept the bid proposal of the PRINCIPAL; and if the PRINCIPAL shall, within the time and as specified in the bidding and contract documents, submit a DBE Utilization Plan that is accepted and approved by the Department; and if, after award by the Department, the PRINCIPAL shall enter into a contract in accordance with the terms of the bidding and contract documents including evidence of the required insurance coverages and providing such bond as specified with good and sufficient surety for the faithful performance of such contract and for the prompt payment of labor and material furnished in the prosecution thereof; or if, in the event of the failure of the PRINCIPAL to make the required DBE submission or to enter into such contract and to give the specified bond, the PRINCIPAL pays to the Department the difference not to exceed the penalty hereof between the amount specified in the bid proposal and such larger amount for which the Department may contract with another party to perform the work covered by said bid proposal, then this obligation shall be null and void, otherwise, it shall remain in full force and effect.

IN THE EVENT the Department determines the PRINCIPAL has failed to comply with any requirement as set forth in the preceding paragraph, then Surety shall pay the penal sum to the Department within fifteen (15) days of written demand therefor. If Surety does not make full payment within such period of time, the Department may bring an action to collect the amount owed. Surety is liable to the Department for all its expenses, including attorney's fees, incurred in any litigation in which it prevails either in whole or in part.

In TESTIMONY WHEREOF, the said PRINCIPAL and the said SURETY have caused this instrument to be signed by their respective officers this day of A.D.,

PRINCIPAL SURETY
(Company Name) (Company Name)
By: (Signature & Title) By: (Signature of Attorney-in-Fact)

Notary Certification for Principal and Surety

STATE OF ILLINOIS,
COUNTY OF

I, a Notary Public in and for said County, do hereby certify that
and

(Insert names of individuals signing on behalf of PRINCIPAL & SURETY)

who are each personally known to me to be the same persons whose names are subscribed to the foregoing instrument on behalf of PRINCIPAL and SURETY, appeared before me this day in person and acknowledged respectively, that they signed and delivered said instrument as their free and voluntary act for the uses and purposes therein set forth.

Given under my hand and notarial seal this day of, A.D.

My commission expires
Notary Public

In lieu of completing the above section of the Proposal Bid Form, the Principal may file an Electronic Bid Bond. By signing below the Principal is ensuring the identified electronic bid bond has been executed and the Principal and Surety are firmly bound unto the State of Illinois under the conditions of the bid bond as shown above.

Electronic Bid Bond ID# Company/Bidder Name Signature and Title

PROPOSAL ENVELOPE



PROPOSALS

for construction work advertised for bids by the
Illinois Department of Transportation

Item No.	Item No.	Item No.

Submitted By:

Name:
Address:
Phone No.

Bidders should use an IDOT proposal envelope or affix this form to the front of a 10" x 13" envelope for the submittal of bids. If proposals are mailed, they should be enclosed in a second or outer envelope addressed to:

Engineer of Design and Environment - Room 326
Illinois Department of Transportation
2300 South Dirksen Parkway
Springfield, Illinois 62764

NOTICE

Individual bids, including Bid Bond and/or supplemental information if required, should be securely stapled.

CONTRACTOR OFFICE COPY OF CONTRACT SPECIFICATIONS

NOTICE

None of the following material needs to be returned with the bid package unless the special provisions require documentation and/or other information to be submitted.

**Contract No. 64D31
WHITESIDE County
Section D2 SPRING RS 2007-2
Route FAP 309
District 2 Construction Funds**



Illinois Department of Transportation



NOTICE TO BIDDERS

1. **TIME AND PLACE OF OPENING BIDS.** Sealed proposals for the improvement described herein will be received by the Department of Transportation at the Harry R. Hanley Building, 2300 South Dirksen Parkway, in Springfield, Illinois until 10:00 o'clock a.m., November 16, 2007. All bids will be gathered, sorted, publicly opened and read in the auditorium at the Department of Transportation's Harry R. Hanley Building shortly after the 10:00 a.m. cut off time.

2. **DESCRIPTION OF WORK.** The proposed improvement is identified and advertised for bids in the Invitation for Bids as:

**Contract No. 64D31
WHITESIDE County
Section D2 SPRING RS 2007-2
Route FAP 309
District 2 Construction Funds**

6.32 miles of 24 feet and variable width HMA resurfacing on U.S. Route 30 from French Creek to Emerson Road near Morrison.

3. **INSTRUCTIONS TO BIDDERS.** (a) This Notice, the invitation for bids, proposal and letter of award shall, together with all other documents in accordance with Article 101.09 of the Standard Specifications for Road and Bridge Construction, become part of the contract. Bidders are cautioned to read and examine carefully all documents, to make all required inspections, and to inquire or seek explanation of the same prior to submission of a bid.

(b) State law, and, if the work is to be paid wholly or in part with Federal-aid funds, Federal law requires the bidder to make various certifications as a part of the proposal and contract. By execution and submission of the proposal, the bidder makes the certification contained therein. A false or fraudulent certification shall, in addition to all other remedies provided by law, be a breach of contract and may result in termination of the contract.

4. **AWARD CRITERIA AND REJECTION OF BIDS.** This contract will be awarded to the lowest responsive and responsible bidder considering conformity with the terms and conditions established by the Department in the rules, Invitation for Bids and contract documents. The issuance of plans and proposal forms for bidding based upon a prequalification rating shall not be the sole determinant of responsibility. The Department reserves the right to determine responsibility at the time of award, to reject any or all proposals, to readvertise the proposed improvement, and to waive technicalities.

By Order of the
Illinois Department of Transportation

Milton R. Sees, Secretary

BD 351 (Rev. 01/2003)

INDEX
FOR
SUPPLEMENTAL SPECIFICATIONS
AND RECURRING SPECIAL PROVISIONS

Adopted January 1, 2007

This index contains a listing of SUPPLEMENTAL SPECIFICATIONS and frequently used RECURRING SPECIAL PROVISIONS.

SUPPLEMENTAL SPECIFICATIONS

Std. Spec. Sec.

Page No.

No Supplemental Specifications this year.

RECURRING SPECIAL PROVISIONS

The following RECURRING SPECIAL PROVISIONS indicated by an "X" are applicable to this contract and are included by reference:

<u>CHECK SHEET #</u>	<u>PAGE NO.</u>
1	1
2	3
3	4
4	14
5	19
6	24
7	25
8	26
9	27
10	30
11	33
12	35
13	39
14	41
15	42
16	44
17	45
18	47
19	48
20	49
21	53
22	55
23	57
24	59
25	60
26	61
27	62
28	63
29	64
30	70
31	78

TABLE OF CONTENTS

LOCATION OF PROJECT	1
DESCRIPTION OF PROJECT	1
TRAFFIC CONTROL PLAN	1
GEOTECHNICAL REINFORCEMENT	3
HOT-MIX ASPHALT MIXTURE IL-9.5FG	5
CEMENT (BDE)	8
DISADVANTAGED BUSINESS ENTERPRISE PARTICIPATION (BDE)	10
DOWEL BARS (BDE)	18
EQUIPMENT RENTAL RATES (BDE).....	18
ERRATA FOR THE 2007 STANDARD SPECIFICATIONS (BDE).....	19
HOT-MIX ASPHALT EQUIPMENT, SPREADING AND FINISHING MACHINE (BDE)	21
HOT-MIX ASPHALT - FIELD VOIDS IN THE MINERAL AGGREGATE (BDE).....	22
PAYMENTS TO SUBCONTRACTORS (BDE)	23
RECLAIMED ASPHALT PAVEMENT (RAP) (BDE)	24
REFLECTIVE SHEETING ON CHANNELIZING DEVICES (BDE)	30
STONE GRADATION TESTING (BDE).....	31
SUBCONTRACTOR MOBILIZATION PAYMENTS (BDE)	31
THERMOPLASTIC PAVEMENT MARKINGS (BDE)	32
WORKING DAYS (BDE).....	33
BITUMINOUS MATERIALS COST ADJUSTMENTS (BDE) (RETURN FORM WITH BID).....	33
STEEL COST ADJUSTMENT (BDE) (RETURN FORM WITH BID).....	36

STATE OF ILLINOIS
SPECIAL PROVISIONS

The following Special Provisions supplement the "Standard Specifications for Road and Bridge Construction," adopted January 1, 2007, the latest edition of the "Manual on Uniform Traffic Control Devices for Streets and Highways," and the "Manual of Test Procedures for Materials" in effect on the date of invitation for bids, and the Supplemental Specifications and Recurring Special Provisions indicated on the Check Sheet included herein which apply to and govern the construction of FAP Route 309 (US 30), Section D2 Spring RS 2007-2, Whiteside County, Contract #64D31, and in case of conflict with any part or parts of said Specifications, the said Special Provisions shall take precedence and shall govern.

LOCATION OF PROJECT

On US 30 from French Creek east of Morrison to Emerson Road.

DESCRIPTION OF PROJECT

Hot-Mix Asphalt resurfacing on US 30 from French Creek east of Morrison to Emerson Road.

TRAFFIC CONTROL PLAN

Effective January 14, 1999

Traffic Control shall be according to the applicable sections of the Standard Specifications for Road and Bridge Construction, the applicable guidelines contained in the National Manual on Uniform Traffic Control Devices for Streets and Highways, Illinois Supplement to the National Manual on Uniform Traffic Control Devices, these special provisions, and any special details and Highway Standards contained herein and in the plans.

Special attention is called to Articles 107.09 and 107.14 of the Standard Specifications for Road and Bridge Construction and the following Highway Standards relating to traffic control.

Standards:

701006 701011 701201 701306 701311 701326 702001

Details:

Rough Grooved Surface Sign (DS 91.2)

Signs:

No additional bracing shall be allowed on post-mounted signs.

Post-mounted signs shall be installed using standard 720011, 728001, 729001, on 4"x4" wood posts, or on any other "break away" connection if accepted by the FHWA and corresponding letter is provided to the resident.

“BUMP” (W8-1(O)48) signs shall be installed as directed by the Engineer.

“UNEVEN LANES” W8-11(O)48 signs shall be installed at 2 mile intervals or as directed by the Engineer on roadways where the posted speed limit is greater than 40 mph.

“LOW SHOULDER” W8-9(O)48 signs shall be installed at 2 mile intervals or as directed by the Engineer.

When covering existing Department signs, no tape shall be used on the reflective portion of the sign. Contact the District sign shop for covering techniques.

Devices:

A minimum of 3 drums spaced at 1.2 meters (4 feet) shall be placed at each return when the sideroad is open.

Flaggers:

Flaggers shall comply with all requirements contained in the Department’s “Flagger Handbook” with the following exception: The ANSI Class 2 vest will not be supplied by the Department.

Pilot Car: During the bituminous priming operation, the Contractor shall be required to provide a pilot car to lead the traffic through the areas primed.

The pilot car shall be a pickup truck, carrying the Contractor's company insignia, equipped with “PILOT CAR - FOLLOW ME” (G-20-4(0)) signs. Two signs shall be mounted on the vehicle so as to be clearly visible from both directions. The bottom of the sign shall be mounted at least 300 mm (one foot) above the top of the cab. The pilot car shall be equipped with a two-way radio so normal communication with the flagger at each end of the work area can be maintained.

The pilot car shall be paid for by the day. If the pilot car is used less than four hours, the operation will be counted as a half day.

This work will be paid for at the contract unit price Per Day for PILOT CAR for each car required by the Engineer.

Maintenance of Traffic: The mainline shall be kept open to one-way traffic at all times during working hours and two-way traffic during non-working hours.

The Contractor shall be required to notify the Whiteside County Highway Department, the corresponding Township Commissioner, emergency response agencies (i.e.: fire, ambulance, police), school bus companies and the Department of Transportation (Bureau of Project Implementation) regarding any changes in traffic control.

The Contractor shall be required to notify the Whiteside County Highway Department and/or corresponding Township Commissioner for any sideroad closure or opening.

The sawing of patches, resurfacing and placing of shoulder aggregate shall be completed using Traffic Control and Protection Standard 701306.

The pavement patch removal and replacement shall be completed using Traffic Control and Protection Standard 701201.

The resurfacing and placing of shoulder aggregate shall be completed using Traffic Control and Protection Standard 701306.

Placing and removing pavement marking shall be completed using Traffic Control and Protection Standard 701306 or 701311.

GEOTECHNICAL REINFORCEMENT

Revised September 1, 2004

Biaxial Geogrid Flat Installation

This work consists of furnishing and installing an integrally-formed polypropylene geotechnical grid reinforcement material. The grid shall have an aperture, rib and junction cross section sufficient to permit significant mechanical interlock with the material being reinforced. There shall be a high continuity of tensile strength through all ribs and junctions of the grid material to reinforce the embankment or subgrade as shown on the plans and specifications.

Materials: Each layer of geogrid shall conform to the property requirements listed below. Multilayer geogrid and multiple layers of lesser strength geogrids will not be accepted.

Reinforcement and Interlock

<u>Property</u>	<u>Test Method</u>	<u>Value</u>
<u>Tensile Modulus:</u>		
▪ True Tensile Modulus	ASTMD 6637	17,000 lb./ft. (Min.)
▪ True Tensile Strength @ 2% Strain		280 lb./ft. (Min.)
▪ True Tensile Strength @5% Strain		580 lb./ft. (Min.)
<u>Apertures:</u>		
▪ Aperture Stability	USACE*	2.7 in. – lb./deg. (min.)
▪ Open Area	COE Method Modified**	70% (Nom.)

- * Resistance to in-plane rotational movement measured by applying a 20 kg-cm moment to the central junction of a 9 inch x 9 inch specimen restrained at its perimeter (U.S. Army Corps of Engineers Methodology for measurement of Torsional Rigidity).

** Percent open area measured without magnification by Corps of Engineers method as specified in CW 02215 Civil Works Construction Guide, November, 1977.

Structural Integrity:

- | | | |
|-----------------------|--------------------|--------------------|
| ▪ Flexural Stiffness | ASTM D-5732-95 *** | 0.2 in.-lb. (Min.) |
| ▪ Junction Efficiency | GRI GG2-87**** | 90% (Min.) |

*** Resistance to bending force measured via ASTM D-5732-95, using specimens of width two ribs wide, with transverse ribs cut flush with exterior edges of longitudinal ribs (as a "ladder), and of length sufficiently long to enable measurement of the overhang dimension. The overall Flexural Stiffness is calculated as the square root of the product of machine-and cross-machine-direction Flexural Stiffness values.

**** Load transfer capability measured via GRI-GG2-87. Expressed as a percentage of ultimate tensile strength.

Material

- | | | |
|---------------|----------------------------------------|-------------|
| Polypropylene | ASTM D 1401
Group I/Class 1/Grade 2 | 98% (Min.) |
| Carbon Black | ASTM 4218 | 0.5% (Min.) |

The supplier should provide a certification that their product meets the above requirements.

The geotechnical reinforcement shall be placed as described herein or as shown on the cross sections.

Geogrid shall be delivered to the jobsite in such a manner as to facilitate handling and incorporation into the work without damage. Material shall be stored in such a manner as to prevent exposure to direct sunlight and damage by other construction activities.

Prior to the installation of the geogrid, the application surface shall be cleared of debris, sharp objects and trees. Tree stumps shall be cut to the level of the ground surface. If the stumps cannot be cut to the ground level, they shall be completely removed. In the case of subgrades, all wheel tracks or ruts in excess of 75 mm (3 inches) in depth shall be graded smooth or otherwise filled with soil to provide a reasonably smooth surface.

The geotechnical reinforcement shall be placed with the "roll length" parallel to the pavement. Fabric of insufficient width or length to fully cover the specified area shall be lapped a minimum of 600 mm (24 inches).

Installation:

The granular blanket shall be constructed to the width and depth required on the plans. Unless otherwise specified, the material shall be back-dumped on the Geogrid in a sequence of operations beginning at the outer edges of the treatment area with subsequent placement towards the middle.

Placement of material on the Geogrid shall be accomplished by spreading dumped material off of previously placed material with a bulldozer blade or endloader, in such a manner as to prevent tearing or shoving of the Geogrid. Dumping of material directly on the Geogrid will only be permitted to establish an initial working platform. No construction equipment shall be allowed on the Geogrid prior to placement of the granular blanket.

Unless otherwise specified in the plans or Special Provisions, the granular material, shall be placed to the full required thickness and compacted.

Geogrid which is damaged during installation or subsequent placement of granular material, due to failure of the Contractor to comply with these provisions, shall be repaired or replaced at his expense, including costs of removal and replacement of the granular material.

Torn Geogrid may be patched in-place by cutting and placing a piece of the same Geogrid over the tear. The dimensions of the patch shall be at least 600 mm (2 feet) larger than the largest dimension of the tear and it shall be weighted or otherwise secured to prevent the granular material from causing lap separation.

Method of Measurement: Geotechnical Reinforcement will be measured in square meters (square yards) for the surface area placed. The excavation, replacement and compaction of the granular layer shall be paid for separately. Each layer of geogrid will be paid for separately.

Basis of Payment: This work will be measured in place and the area computed in square yards. The work will be paid for at the contract unit price per Square Meter (Square Yard) for GEOTECHNICAL REINFORCEMENT.

HOT-MIX ASPHALT MIXTURE IL-9.5FG

Effective: July 1, 2005

Revised: March 15, 2007

Description. This work shall consist of constructing fine graded hot-mix asphalt (HMA) surface course or leveling binder with an IL-9.5FG mixture. Work shall be according to Sections 406 and 1030 of the Standard Specifications, except as modified herein.

Materials. Revise Article 1003.03(c) of the Standard Specifications to read:

“(c) Gradation. The fine aggregate gradation for all HMA shall be FA 1, FA 2, FA 20, or FA 21. For mixture IL-9.5FG, the fine aggregate fraction shall consist of at least 67 percent manufactured sand meeting FA 20 gradation. The manufactured sand shall be stone sand, slag sand, steel slag sand, or combinations thereof.”

Mixture Design. Add the following to the table in Article 1030.04(a)(1):

"High ESAL, MIXTURE COMPOSITION (% PASSING) ^{1/}		
Sieve Size	IL-9.5FG	
	min	max
1 1/2 in. (37.5 mm)		
1 in. (25 mm)		
3/4 in. (19 mm)		
1/2 in. (12.5 mm)		100
3/8 in. (9.5 mm)	90	100
#4 (4.75 mm)	60	72
#8 (2.36 mm)	43	53
#16 (1.18 mm)	25	35
#30 (600 μm)	17	27
#50 (300 μm)	8	15
#100 (150 μm)	6	10
#200 (75 μm)	4	6
Ratio Dust/Asphalt Binder		1.0"

Revise the table in Article 1030.04(b)(1) of the Standard Specifications to read:

"VOLUMETRIC REQUIREMENTS High ESAL					
Ndesign	Voids in the Mineral Aggregate (VMA), % minimum				Voids Filled with Asphalt Binder (VFA), %
	IL-25.0	IL-19.0	IL-12.5	IL-9.5	
50	12.0	13.0	14.0	15 ^{1/}	65 - 78
70					65 - 75 ^{2/}
90					
105					

1/ The VMA for IL-9.5FG shall be a minimum of 15.0 percent.

2/ The VFA range for IL-9.5FG shall be 65 - 78 percent."

Quality Control/Quality Assurance (QC/QA). Revise the second table in Article 1030.05(d)(4) to read:

"DENSITY CONTROL LIMITS			
Mixture Composition		Parameter	Individual Test
IL-9.5FG	Lifts < 1.25 in. (32 mm)	N _{design} 50 - 105	91.0 – 97.0% ^{2/}
	Lifts ≥ 1.25 in. (32 mm)	N _{design} 50 - 105	93.0 – 97.0%
IL-9.5, IL-12.5		N _{design} ≥ 90	92.0 – 96.0 %
IL-9.5, IL-9.5L, IL-12.5		N _{design} < 90	92.5 – 97.4 %
IL-19.0, IL-25.0		N _{design} ≥ 90	93.0 – 96.0 %
IL-19.0, IL-19.0L, IL-25.0		N _{design} < 90	93.0 – 97.4 %
All Other		N _{design} = 30	93.0 ^{1/} - 97.4 %

1/ 92.0 % when placed as first lift on an unimproved subgrade.

2/ Based on core density test results.”

CONSTRUCTION REQUIREMENTS

Leveling Binder. Revise the table and second paragraph of Article 406.05(c) of the Standard Specifications to read:

"Leveling Binder	
Nominal, Compacted, Leveling Binder Thickness, in. (mm)	Mixture Composition
≤ 1 1/4 (32)	IL-9.5, IL-9.5 FG, or IL-9.5L
> 1 1/4 to 2 (32 to 50)	IL-9.5, IL-9.5FG, IL-9.5L, or IL-12.5

The density requirements of Article 1030.05(d)(4) shall apply for leveling binder, machine method, when the nominal, compacted thickness is: 3/4 in. (19 mm) or greater for IL-9.5FG mixtures, 1 1/4 in. (32 mm) or greater for IL-9.5 and IL-9.5L mixtures, and 1 1/2 in. (38 mm) or greater for IL-12.5 mixtures.”

Compaction. Add the following footnote 4/ for “V_D” in the “Breakdown Roller” column of Table 1 in Article 406.07 of the Standard Specifications:

“4/ Vibratory rolling will not be permitted for IL-9.5FG leveling binder.”

Delete footnote 3/ from Table 1 of Article 406.07 of the Standard Specifications.

Basis of Payment. Add the following two paragraphs after the third paragraph of Article 406.14 of the Standard Specifications:

”Mixture IL-9.5FG will be paid for at the contract unit price per ton (metric ton) for LEVELING BINDER (HAND METHOD), IL-9.5FG, of the N_{design} specified; LEVELING BINDER (MACHINE METHOD), IL-9.5FG, of the N_{design} specified; or HOT-MIX ASPHALT SURFACE COURSE, IL-9.5FG, of the N_{design} specified.

Mixture IL-9.5FG in which polymer modified asphalt binders are required will be paid for at the contract unit price per ton (metric ton) for POLYMERIZED LEVELING BINDER (HAND METHOD), IL-9.5FG, of the Ndesign specified; POLYMERIZED LEVELING BINDER (MACHINE METHOD), IL-9.5FG, of the Ndesign specified; or POLYMERIZED HOT-MIX ASPHALT SURFACE COURSE, IL-9.5FG, of the Ndesign specified.”

CEMENT (BDE)

Effective: January 1, 2007

Revised: November 1, 2007

Revise Section 1001 of the Standard Specifications to read:

“SECTION 1001. CEMENT

1001.01 Cement Types. Cement shall be according to the following.

- (a) Portland Cement. Acceptance of portland cement shall be according to the current Bureau of Materials and Physical Research’s Policy Memorandum, “Portland or Blended Cement Acceptance Procedure for Qualified and Non-Qualified Plants”.

Portland cement shall be according to ASTM C 150, and shall meet the standard physical and chemical requirements. Type I or Type II may be used for cast-in-place, precast, and precast prestressed concrete. Type III may be used according to Article 1020.04, or when approved by the Engineer. All other cements referenced in ASTM C 150 may be used when approved by the Engineer.

The total of all organic processing additions shall be a maximum of 1.0 percent by weight (mass) of the cement and the total of all inorganic processing additions shall be a maximum of 4.0 percent by weight (mass) of the cement. Organic processing additions shall be limited to grinding aids that improve the flowability of cement, reduce pack set, and improve grinding efficiency. Inorganic processing additions shall be limited to granulated blast-furnace slag according to the chemical requirements of AASHTO M 302 and Class C fly ash according to the chemical requirements of AASHTO M 295.

- (b) Portland-Pozzolan Cement. Acceptance of portland-pozzolan cement shall be according to the current Bureau of Materials and Physical Research’s Policy Memorandum, “Portland or Blended Cement Acceptance Procedure for Qualified and Non-Qualified Plants”.

Portland-pozzolan cement shall be according to ASTM C 595 and shall meet the standard physical and chemical requirements. Type IP or I(PM) may be used for cast-in-place, precast, and precast prestressed concrete, except when Class PP concrete is used. The pozzolan constituent for Type IP shall be a maximum of 21 percent of the weight (mass) of the portland-pozzolan cement. All other cements referenced in ASTM C 595 may be used when approved by the Engineer.

For cast-in-place construction, portland-pozzolan cements shall not be used in concrete mixtures when the air temperature is below 40 °F (4 °C) without permission of the Engineer. If permission is given, the mix design strength requirement may require the Contractor to increase the cement or eliminate the cement factor reduction for a water-reducing or high range water-reducing admixture which is permitted according to Article 1020.05(b).

The total of all organic processing additions shall be a maximum of 1.0 percent by weight (mass) of the cement. Organic processing additions shall be limited to grinding aids as defined in (a) above. Inorganic processing additions shall not be used.

- (c) Portland Blast-Furnace Slag Cement. Acceptance of portland blast-furnace slag cement shall be according to the current Bureau of Materials and Physical Research's Policy Memorandum, "Portland or Blended Cement Acceptance Procedure for Qualified and Non-Qualified Plants".

Portland blast-furnace slag cement shall be according to ASTM C 595 and shall meet the standard physical and chemical requirements. Type I(SM) slag-modified portland cement may be used for cast-in-place, precast, and precast prestressed concrete, except when Class PP concrete is used. All other cements referenced in ASTM C 595 may be used when approved by the Engineer.

For cast-in-place construction, portland blast-furnace slag cements shall not be used in concrete mixtures when the air temperature is below 40 °F (4 °C) without permission of the Engineer. If permission is given, the mix design strength requirement may require the Contractor to increase the cement or eliminate the cement factor reduction for a water-reducing or high range water-reducing admixture which is permitted according to Article 1020.05(b).

The total of all organic processing additions shall be a maximum of 1.0 percent by weight (mass) of the cement. Organic processing additions shall be limited to grinding aids as defined in (a) above. Inorganic processing additions shall not be used.

- (d) Rapid Hardening Cement. Rapid hardening cement shall be used according to Article 1020.04 or when approved by the Engineer. The cement shall be on the Department's current "Approved List of Packaged, Dry, Rapid Hardening Cementitious Materials for Concrete Repairs", and shall be according to the following.

(1) The cement shall have a maximum final set of 25 minutes, according to Illinois Modified ASTM C 191.

(2) The cement shall have a minimum compressive strength of 2000 psi (13,800 kPa) at 3.0 hours, and 4000 psi (27,600 kPa) at 24.0 hours, according to Illinois Modified ASTM C 109.

(3) The cement shall have a maximum drying shrinkage of 0.050 percent at seven days, according to Illinois Modified ASTM C 596.

- (4) The cement shall have a maximum expansion of 0.020 percent at 14 days, according to Illinois Modified ASTM C 1038.
- (5) The cement shall have a minimum 80 percent relative dynamic modulus of elasticity; and shall not have a weight (mass) gain in excess of 0.15 percent or a weight (mass) loss in excess of 1.0 percent, after 100 cycles, according to Illinois Modified AASHTO T 161, Procedure B. At 100 cycles, the specimens are measured and weighed at 73 °F (23 °C).
- (e) Calcium Aluminate Cement. Calcium aluminate cement shall be used when specified by the Engineer. The cement shall meet the standard physical requirements for Type I cement according to ASTM C 150, except the time of setting shall not apply. The chemical requirements shall be determined according to ASTM C 114 and shall be as follows: minimum 38 percent aluminum oxide (Al₂O₃), maximum 42 percent calcium oxide (CaO), maximum 1 percent magnesium oxide (MgO), maximum 0.4 percent sulfur trioxide (SO₃), maximum 1 percent loss on ignition, and maximum 3.5 percent insoluble residue.

1001.02 Uniformity of Color. Cement contained in single loads or in shipments of several loads to the same project shall not have visible differences in color.

1001.03 Mixing Brands and Types. Different brands or different types of cement from the same manufacturing plant, or the same brand or type from different plants shall not be mixed or used alternately in the same item of construction unless approved by the Engineer.

1001.04 Storage. Cement shall be stored and protected against damage, such as dampness which may cause partial set or hardened lumps. Different brands or different types of cement from the same manufacturing plant, or the same brand or type from different plants shall be kept separate.”

DISADVANTAGED BUSINESS ENTERPRISE PARTICIPATION (DBE)

Effective: September 1, 2000

Revised: January 1, 2007

FEDERAL OBLIGATION. The Department of Transportation, as a recipient of federal financial assistance, is required to take all necessary and reasonable steps to ensure nondiscrimination in the award and administration of contracts. Consequently, the federal regulatory provisions of 49 CFR part 26 apply to this contract concerning the utilization of disadvantaged business enterprises. For the purposes of this Special Provision, a disadvantaged business enterprise (DBE) means a business certified by the Department in accordance with the requirements of 49 CFR part 26 and listed in the DBE Directory or most recent addendum.

STATE OBLIGATION. This Special Provision will also be used by the Department to satisfy the requirements of the Business Enterprise for Minorities, Females, and Persons with Disabilities Act, 30 ILCS 575. When this Special Provision is used to satisfy state law requirements on 100 percent state-funded contracts, the federal government has no involvement in such contracts (not a federal-aid contract) and no responsibility to oversee the implementation of this

Special Provision by the Department on those contracts. DBE participation on 100 percent state-funded contracts will not be credited toward fulfilling the Department's annual overall DBE goal required by the US Department of Transportation to comply with the federal DBE program requirements.

CONTRACTOR ASSURANCE. The Contractor makes the following assurance and agrees to include the assurance in each subcontract that the Contractor signs with a subcontractor:

The Contractor, subrecipient, or subcontractor shall not discriminate on the basis of race, color, national origin, or sex in the performance of this contract. The Contractor shall carry out applicable requirements of 49 CFR part 26 in the award and administration of contracts funded in whole or in part with federal or state funds. Failure by the Contractor to carry out these requirements is a material breach of this contract, which may result in the termination of this contract or such other remedy as the recipient deems appropriate.

OVERALL GOAL SET FOR THE DEPARTMENT. As a requirement of compliance with 49 CFR part 26, the Department has set an overall goal for DBE participation in its federally assisted contracts. That goal applies to all federal-aid funds the Department will expend in its federally assisted contracts for the subject reporting fiscal year. The Department is required to make a good faith effort to achieve the overall goal. The dollar amount paid to all approved DBE firms performing work called for in this contract is eligible to be credited toward fulfillment of the Department's overall goal.

CONTRACT GOAL TO BE ACHIEVED BY THE CONTRACTOR. This contract includes a specific DBE utilization goal established by the Department. The goal has been included because the Department has determined that the work of this contract has subcontracting opportunities that may be suitable for performance by DBE companies. This determination is based on an assessment of the type of work, the location of the work, and the availability of DBE companies to do a part of the work. The assessment indicates that, in the absence of unlawful discrimination, and in an arena of fair and open competition, DBE companies can be expected to perform **4.0%** of the work. This percentage is set as the DBE participation goal for this contract. Consequently, in addition to the other award criteria established for this contract, the Department will award this contract to a bidder who makes a good faith effort to meet this goal of DBE participation in the performance of the work. A bidder makes a good faith effort for award consideration if either of the following is done in accordance with the procedures set forth in this Special Provision:

- (a) The bidder documents that firmly committed DBE participation has been obtained to meet the goal; or
- (b) The bidder documents that a good faith effort has been made to meet the goal, even though the effort did not succeed in obtaining enough DBE participation to meet the goal.

DBE LOCATOR REFERENCES. Bidders may consult the DBE Directory as a reference source for DBE companies certified by the Department. In addition, the Department maintains a letting and item specific DBE locator information system whereby DBE companies can register their

interest in providing quotes on particular bid items advertised for letting. Information concerning DBE companies willing to quote work for particular contracts may be obtained by contacting the Department's Bureau of Small Business Enterprises at telephone number (217)785-4611, or by visiting the Department's web site at www.dot.il.gov.

BIDDING PROCEDURES. Compliance with the bidding procedures of this Special Provision is required prior to the award of the contract and the failure of the as-read low bidder to comply will render the bid not responsive.

- (a) In order to assure the timely award of the contract, the as-read low bidder shall submit a Disadvantaged Business Utilization Plan on Department form SBE 2026 within seven working days after the date of letting. To meet the seven day requirement, the bidder may send the Plan by certified mail or delivery service within the seven working day period. If a question arises concerning the mailing date of a Plan, the mailing date will be established by the U.S. Postal Service postmark on the original certified mail receipt from the U.S. Postal Service or the receipt issued by a delivery service. It is the responsibility of the bidder to ensure that the postmark or receipt date is affixed within the seven working days if the bidder intends to rely upon mailing or delivery to satisfy the submission day requirement. The Plan is to be submitted to the Department of Transportation, Bureau of Small Business Enterprises, Contract Compliance Section, 2300 South Dirksen Parkway, Room 319, Springfield, Illinois 62764 (Telefax: (217)785-1524). It is the responsibility of the bidder to obtain confirmation of telefax delivery. The Department will not accept a Utilization Plan if it does not meet the seven day submittal requirement and the bid will be declared not responsive. In the event the bid is declared not responsive due to a failure to submit a Plan or failure to comply with the bidding procedures set forth herein, the Department may elect to cause the forfeiture of the penal sum of the bidder's proposal guaranty, and may deny authorization to bid the project if re-advertised for bids. The Department reserves the right to invite any other bidder to submit a Utilization Plan at any time for award consideration or to extend the time for award.
- (b) The Utilization Plan shall indicate that the bidder either has obtained sufficient DBE participation commitments to meet the contract goal or has not obtained enough DBE participation commitments in spite of a good faith effort to meet the goal. The Utilization Plan shall further provide the name, telephone number, and telefax number of a responsible official of the bidder designated for purposes of notification of plan approval or disapproval under the procedures of this Special Provision.
- (c) The Utilization Plan shall include a DBE Participation Commitment Statement, Department form SBE 2025, for each DBE proposed for the performance of work to achieve the contract goal. The signatures on these forms must be original signatures. All elements of information indicated on the said form shall be provided, including but not limited to the following:
 - (1) The name and address of each DBE to be used;

- (2) A description, including pay item numbers, of the commercially useful work to be done by each DBE;
 - (3) The price to be paid to each DBE for the identified work specifically stating the quantity, unit price, and total subcontract price for the work to be completed by the DBE. If partial pay items are to be performed by the DBE, indicate the portion of each item, a unit price where appropriate and the subcontract price amount;
 - (4) A commitment statement signed by the bidder and each DBE evidencing availability and intent to perform commercially useful work on the project; and
 - (5) If the bidder is a joint venture comprised of DBE firms and non-DBE firms, the plan must also include a clear identification of the portion of the work to be performed by the DBE partner(s).
- (d) The contract will not be awarded until the Utilization Plan submitted by the bidder is approved. The Utilization Plan will be approved by the Department if the Plan commits sufficient commercially useful DBE work performance to meet the contract goal. The Utilization Plan will not be approved by the Department if the Plan does not commit sufficient DBE performance to meet the contract goal unless the bidder documents that it made a good faith effort to meet the goal. The good faith procedures of Section VIII of this special provision apply. If the Utilization Plan is not approved because it is deficient in a technical matter, unless waived by the Department, the bidder will be notified and will be allowed no less than a five working day period in order to cure the deficiency.

CALCULATING DBE PARTICIPATION. The Utilization Plan values represent work anticipated to be performed and paid for upon satisfactory completion. The Department is only able to count toward the achievement of the overall goal and the contract goal the value of payments made for the work actually performed by DBE companies. In addition, a DBE must perform a commercially useful function on the contract to be counted. A commercially useful function is generally performed when the DBE is responsible for the work and is carrying out its responsibilities by actually performing, managing, and supervising the work involved. The Department and Contractor are governed by the provisions of 49 CFR part 26.55(c) on questions of commercially useful functions as it affects the work. Specific counting guidelines are provided in 49 CFR part 26.55, the provisions of which govern over the summary contained herein.

- (a) DBE as the Contractor: 100 percent goal credit for that portion of the work performed by the DBE's own forces, including the cost of materials and supplies. Work that a DBE subcontracts to a non-DBE firm does not count toward the DBE goals.
- (b) DBE as a joint venture Contractor: 100 percent goal credit for that portion of the total dollar value of the contract equal to the distinct, clearly defined portion of the work performed by the DBE's own forces.
- (c) DBE as a subcontractor: 100 percent goal credit for the work of the subcontract performed by the DBE's own forces, including the cost of materials and supplies,

excluding the purchase of materials and supplies or the lease of equipment by the DBE subcontractor from the prime Contractor or its affiliates. Work that a DBE subcontractor in turn subcontracts to a non-DBE firm does not count toward the DBE goal.

- (d) DBE as a trucker: 100 percent goal credit for trucking participation provided the DBE is responsible for the management and supervision of the entire trucking operation for which it is responsible. At least one truck owned, operated, licensed, and insured by the DBE must be used on the contact. Credit will be given for the full value of all such DBE trucks operated using DBE employed drivers. Goal credit will be limited to the value of the reasonable fee or commission received by the DBE if trucks are leased from a non-DBE company.
- (e) DBE as a material supplier:
 - (1) 60 percent goal credit for the cost of the materials or supplies purchased from a DBE regular dealer.
 - (2) 100 percent goal credit for the cost of materials or supplies obtained from a DBE manufacturer.
 - (3) 100 percent credit for the value of reasonable fees and commissions for the procurement of materials and supplies if not a regular dealer or manufacturer.

GOOD FAITH EFFORT PROCEDURES. If the bidder cannot obtain sufficient DBE commitments to meet the contract goal, the bidder must document in the Utilization Plan the good faith efforts made in the attempt to meet the goal. This means that the bidder must show that all necessary and reasonable steps were taken to achieve the contract goal. Necessary and reasonable steps are those which could reasonably be expected to obtain sufficient DBE participation. The Department will consider the quality, quantity, and intensity of the kinds of efforts that the bidder has made. Mere *pro forma* efforts are not good faith efforts; rather, the bidder is expected to have taken those efforts that would be reasonably expected of a bidder actively and aggressively trying to obtain DBE participation sufficient to meet the contract goal.

- (a) The following is a list of types of action that the Department will consider as part of the evaluation of the bidder's good faith efforts to obtain participation. These listed factors are not intended to be a mandatory checklist and are not intended to be exhaustive. Other factors or efforts brought to the attention of the Department may be relevant in appropriate cases, and will be considered by the Department.
 - (1) Soliciting through all reasonable and available means (e.g. attendance at pre-bid meetings, advertising and/or written notices) the interest of all certified DBE companies that have the capability to perform the work of the contract. The bidder must solicit this interest within sufficient time to allow the DBE companies to respond to the solicitation. The bidder must determine with certainty if the DBE companies are interested by taking appropriate steps to follow up initial solicitations.

- (2) Selecting portions of the work to be performed by DBE companies in order to increase the likelihood that the DBE goals will be achieved. This includes, where appropriate, breaking out contract work items into economically feasible units to facilitate DBE participation, even when the prime Contractor might otherwise prefer to perform these work items with its own forces.
- (3) Providing interested DBE companies with adequate information about the plans, specifications, and requirements of the contract in a timely manner to assist them in responding to a solicitation.
- (4) a. Negotiating in good faith with interested DBE companies. It is the bidder's responsibility to make a portion of the work available to DBE subcontractors and suppliers and to select those portions of the work or material needs consistent with the available DBE subcontractors and suppliers, so as to facilitate DBE participation. Evidence of such negotiation includes the names, addresses, and telephone numbers of DBE companies that were considered; a description of the information provided regarding the plans and specifications for the work selected for subcontracting; and evidence as to why additional agreements could not be reached for DBE companies to perform the work.

b. A bidder using good business judgment would consider a number of factors in negotiating with subcontractors, including DBE subcontractors, and would take a firm's price and capabilities as well as contract goals into consideration. However, the fact that there may be some additional costs involved in finding and using DBE companies is not in itself sufficient reason for a bidder's failure to meet the contract DBE goal, as long as such costs are reasonable. Also, the ability or desire of a bidder to perform the work of a contract with its own organization does not relieve the bidder of the responsibility to make good faith efforts. Bidders are not, however, required to accept higher quotes from DBE companies if the price difference is excessive or unreasonable.
- (5) Not rejecting DBE companies as being unqualified without sound reasons based on a thorough investigation of their capabilities. The bidder's standing within its industry, membership in specific groups, organizations, or associations and political or social affiliations (for example union vs. non-union employee status) are not legitimate causes for the rejection or non-solicitation of bids in the bidder's efforts to meet the project goal.
- (6) Making efforts to assist interested DBE companies in obtaining bonding, lines of credit, or insurance as required by the recipient or Contractor.
- (7) Making efforts to assist interested DBE companies in obtaining necessary equipment, supplies, materials, or related assistance or services.
- (8) Effectively using the services of available minority/women community organizations; minority/women contractors' groups; local, state, and federal minority/women business assistance offices; and other organizations as allowed on a case-by-case basis to provide assistance in the recruitment and placement of DBE companies.

- (b) If the Department determines that the bidder has made a good faith effort to secure the work commitment of DBE companies to meet the contract goal, the Department will award the contract provided that it is otherwise eligible for award. If the Department determines that a good faith effort has not been made, the Department will notify the bidder of that preliminary determination by contacting the responsible company official designated in the Utilization Plan. The preliminary determination shall include a statement of reasons why good faith efforts have not been found, and may include additional good faith efforts that the bidder could take. The notification will designate a five working day period during which the bidder shall take additional efforts. The bidder is not limited by a statement of additional efforts, but may take other action beyond any stated additional efforts in order to obtain additional DBE commitments. The bidder shall submit an amended Utilization Plan if additional DBE commitments to meet the contract goal are secured. If additional DBE commitments sufficient to meet the contract goal are not secured, the bidder shall report the final good faith efforts made in the time allotted. All additional efforts taken by the bidder will be considered as part of the bidder's good faith efforts. If the bidder is not able to meet the goal after taking additional efforts, the Department will make a pre-final determination of the good faith efforts of the bidder and will notify the designated responsible company official of the reasons for an adverse determination.
- (c) The bidder may request administrative reconsideration of a pre-final determination adverse to the bidder within the five working days after the notification date of the determination by delivering the request to the Department of Transportation, Bureau of Small Business Enterprises, Contract Compliance Section, 2300 South Dirksen Parkway, Room 319, Springfield, Illinois 62764 (Telefax: (217)785-1524). Deposit of the request in the United States mail on or before the fifth business day shall not be deemed delivery. The pre-final determination shall become final if a request is not made and delivered. A request may provide additional written documentation and/or argument concerning the issue of whether an adequate good faith effort was made to meet the contract goal. In addition, the request shall be considered a consent by the bidder to extend the time for award. The request will be forwarded to the Department's Reconsideration Officer. The Reconsideration Officer will extend an opportunity to the bidder to meet in person in order to consider all issues of whether the bidder made a good faith effort to meet the goal. After the review by the Reconsideration Officer, the bidder will be sent a written decision within ten working days after receipt of the request for reconsideration, explaining the basis for finding that the bidder did or did not meet the goal or make adequate good faith efforts to do so. A final decision by the Reconsideration Officer that a good faith effort was made shall approve the Utilization Plan submitted by the bidder and shall clear the contract for award. A final decision that a good faith effort was not made shall render the bid not responsive.

CONTRACT COMPLIANCE. Compliance with this Special Provision is an essential part of the contract. The Department is prohibited by federal regulations from crediting the participation of a DBE included in the Utilization Plan toward either the contract goal or the Department's overall goal until the amount to be applied toward the goals has been paid to the DBE. The following administrative procedures and remedies govern the compliance by the Contractor with the contractual obligations established by the Utilization Plan. After approval of the Plan and award

of the contract, the Utilization Plan and individual DBE Participation Statements become part of the contract. If the Contractor did not succeed in obtaining enough DBE participation to achieve the advertised contract goal, and the Utilization Plan was approved and contract awarded based upon a determination of good faith, the total dollar value of DBE work calculated in the approved Utilization Plan as a percentage of the awarded contract value shall become the amended contract goal.

- (a) No amendment to the Utilization Plan may be made without prior written approval from the Department's Bureau of Small Business Enterprises. All requests for amendment to the Utilization Plan shall be submitted to the Department of Transportation, Bureau of Small Business Enterprises, Contract Compliance Section, 2300 South Dirksen Parkway, Room 319, Springfield, Illinois 62764. Telephone number (217) 785-4611. Telefax number (217) 785-1524.
- (b) All work indicated for performance by an approved DBE shall be performed, managed, and supervised by the DBE executing the Participation Statement. The Contractor shall not terminate for convenience a DBE listed in the Utilization Plan and then perform the work of the terminated DBE with its own forces, those of an affiliate or those of another subcontractor, whether DBE or not, without first obtaining the written consent of the Bureau of Small Business Enterprises to amend the Utilization Plan. If a DBE listed in the Utilization Plan is terminated for reasons other than convenience, or fails to complete its work on the contract for any reason, the Contractor shall make good faith efforts to find another DBE to substitute for the terminated DBE. The good faith efforts shall be directed at finding another DBE to perform at least the same amount of work under the contract as the DBE that was terminated, but only to the extent needed to meet the contract goal or the amended contract goal. The Contractor shall notify the Bureau of Small Business Enterprises of any termination for reasons other than convenience, and shall obtain approval for inclusion of the substitute DBE in the Utilization Plan. If good faith efforts following a termination of a DBE for cause are not successful, the Contractor shall contact the Bureau and provide a full accounting of the efforts undertaken to obtain substitute DBE participation. The Bureau will evaluate the good faith efforts in light of all circumstances surrounding the performance status of the contract, and determine whether the contract goal should be amended.
- (c) The Contractor shall maintain a record of payments for work performed to the DBE participants. The records shall be made available to the Department for inspection upon request. After the performance of the final item of work or delivery of material by a DBE and final payment therefor to the DBE by the Contractor, but not later than thirty calendar days after payment has been made by the Department to the Contractor for such work or material, the Contractor shall submit a DBE Payment Report on Department form SBE 2115 to the Regional Engineer. If full and final payment has not been made to the DBE, the Report shall indicate whether a disagreement as to the payment required exists between the Contractor and the DBE or if the Contractor believes that the work has not been satisfactorily completed. If the Contractor does not have the full amount of work indicated in the Utilization Plan performed by the DBE companies indicated in the Plan, the Department will deduct from contract payments to the Contractor the amount of the goal not achieved as liquidated and ascertained damages.

- (d) The Department reserves the right to withhold payment to the Contractor to enforce the provisions of this Special Provision. Final payment shall not be made on the contract until such time as the Contractor submits sufficient documentation demonstrating achievement of the goal in accordance with this Special Provision or after liquidated damages have been determined and collected.
- (e) Notwithstanding any other provision of the contract, including but not limited to Article 109.09 of the Standard Specifications, the Contractor may request administrative reconsideration of a decision to deduct the amount of the goal not achieved as liquidated damages. A request to reconsider shall be delivered to the Contract Compliance Section and shall be handled and considered in the same manner as set forth in paragraph (c) of "Good Faith Effort Procedures" of this Special Provision, except a final decision that a good faith effort was not made during contract performance to achieve the goal agreed to in the Utilization Plan shall be the final administrative decision of the Department.

DOWEL BARS (BDE)

Effective: April 1, 2007

Revise the fifth sentence of Article 1006.11(b) of the Standard Specifications to read:

"The bars shall be epoxy coated according to AASHTO M 284, except the thickness of the epoxy shall be 7 to 12 mils (0.18 to 0.30 mm)."

EQUIPMENT RENTAL RATES (BDE)

Effective: August 2, 2007

Replace the second and third paragraphs of Article 105.07(b)(4)a. of the Standard Specifications with the following:

"Equipment idled which cannot be used on other work, and which is authorized to standby on the project site by the Engineer, will be paid for according to Article 109.04(b)(4)."

Replace Article 109.04(b)(4) of the Standard Specifications with the following:

- "(4) Equipment. Equipment used for extra work shall be authorized by the Engineer. The equipment shall be specifically described, be of suitable size and capacity for the work to be performed, and be in good operating condition. For such equipment, the Contractor will be paid as follows.
 - a. Contractor Owned Equipment. Contractor owned equipment will be paid for by the hour using the applicable rate from the "Equipment Watch Rental Rate Blue Book" (Blue Book). The applicable hourly rate is defined as the FHWA hourly rate, from the time period the force account work begins, adjusted for both the

model year of the equipment and the Illinois region. The time allowed will be the actual time the equipment is operating on the extra work. For the time required to move the equipment to and from the site of the extra work and any authorized idle (standby) time, payment will be made according to: $0.5 \times (\text{AHR} - \text{EOC})$.

Where: AHR = Applicable Hourly Rate (defined above)
EOC = Estimated Operating Costs per hour (from the Blue Book)

All time allowed shall fall within the working hours authorized for the extra work.

The rates above include the cost of fuel, oil, lubrication, supplies, small tools, necessary attachments, repairs, overhaul and maintenance of any kind, depreciation, storage, overhead, profits, insurance, and all incidentals. The rates do not include labor.

The Contractor shall submit to the Engineer sufficient information for each piece of equipment and its attachments to enable the Engineer to determine the proper equipment category. If a rate is not established in the Blue Book for a particular piece of equipment, the Engineer will establish a rate for that piece of equipment that is consistent with its cost and use in the industry.

- b. Rented Equipment. Whenever it is necessary for the Contractor to rent equipment to perform extra work, the rental and transportation costs of the equipment plus five percent for overhead will be paid. In no case shall the rental rates exceed those of established distributors or equipment rental agencies.

All prices shall be agreed to in writing before the equipment is used.”

ERRATA FOR THE 2007 STANDARD SPECIFICATIONS (BDE)

Effective: January 1, 2007

Revised: August 1, 2007

- Page 60 Article 109.07(a). In the second line of the first paragraph change “amount” to “quantity”.
- Page 154 Article 312.05. In the second line of the fifth paragraph change “180 °C” to “175 °C”.
- Page 207 Article 406.14. In the second line of the second paragraph change “MIXTURE FOR CRACKS, JOINTS, AND FLANGEWAYS, of the mixture composition specified;” to “MIXTURE FOR CRACKS, JOINTS, AND FLANGEWAYS;”.
- Page 237 Article 420.18. In the second line of the first paragraph change “October 15” to “November 1”.
- Page 345 Article 505.08(l). In the third line of the first paragraph change “1/8 mm” to “1/8 in.”.

- Page 345 Article 505.08(l). In the nineteenth line of the first paragraph change “is” to “in”.
- Page 379 Article 512.15. In the first and sixth lines of the third paragraph change “50 percent” to “ten percent”.
- Page 383 Article 516.04(b)(1). In the fifth line of the first paragraph change “drillingpouring” to “pouring”.
- Page 390 Article 520.02(h). Change “1027.021” to “1027.01”.
- Page 398 Article 540.07(b). Add the following two paragraphs after the third paragraph:
“Excavation in rock will be measured for payment according to Article 502.12.
Removal and disposal of unstable and/or unsuitable material below plan bedding grade will be measured for payment according to Article 202.07.”
- Page 398 Article 540.08. Add the following two paragraphs after the fifth paragraph:
“Excavation in rock will be paid for according to Article 502.13.
Removal and disposal of unstable and/or unsuitable material below plan bedding grade will be paid for according to Article 202.08.”
- Page 435 Article 542.04(b). Delete the last sentence of the last paragraph.
- Page 465 Article 551.06. In the second line of the first paragraph change “or” to “and/or”.
- Page 585 Article 701.19(a). Add “701400” to the second line of the first paragraph.
- Page 586 Article 701.19(c). Delete “701400” from the second line of the first paragraph.
- Page 586 Article 701.19. Add the following subparagraph to this Article:
“(f) Removal of existing pavement markings and raised reflective pavement markers will be measured for payment according to Article 783.05.”
- Page 587 Article 701.20(b). Delete “TRAFFIC CONTROL AND PROTECTION STANDARD 701400;” from the first paragraph.
- Page 588 Article 701.20. Add the following subparagraph to this Article.
“(j) Removal of existing pavement markings and raised reflective pavement markers will be paid for according to Article 783.06.”
- Page 639 Article 805.04. In the first line of the second paragraph change “changes” to “charges”.

- Page 762 Article 1020.04. In Table 1 Classes of Portland Cement Concrete and Mix Design Criteria, add to the minimum cement factor for Class PC Concrete “5.65 (TY III)”, and add to the maximum cement factor for Class PC Concrete “7.05 (TY III)”.
- Page 765 Article 1020.04. In Table 1 Classes of Portland Cement Concrete and Mix Design Criteria (metric), add to the minimum cement factor for Class PC Concrete “335 (TY III)”, and add to the maximum cement factor for Class PC Concrete “418 (TY III)”.
- Page 800 Article 1030.05(a)(12). Revise “Dust Collection Factor” to “Dust Correction Factor”.
- Page 800 Article 1030.05(a)(14). Revise the first occurrence of Article 1030.05(a)(14) to Article 1030.05(a)(13).
- Page 800 Article 1030.05(a). Add to the list of QC/QA documents “(16) Calibration of Equipment for Asphalt Content Determination”.
- Page 809 Article 1030.05. Revise the subparagraph “(a) Quality Assurance by the Engineer.” to read “(e) Quality Assurance by the Engineer.”.
- Page 889 Article 1069.02(a)(2). In the third line of the first paragraph add “stainless steel” in front of “screws”.
- Page 889 Article 1069.02(b). Delete the third paragraph.
- Page 890 Article 1069.02(c). Delete subparagraph (c).
- Page 946 Article 1080.03(a)(1). In the third line of the first paragraph revise “(300 µm)” to “(600 µm)”.
- Page 963 Article 1083.02(b). In the second line of the first paragraph revise “ASTM D 4894” to “ASTM D 4895”.
- Page 1076 In the Index of Pay Items delete the pay item “BITUMINOUS SURFACE REMOVAL – BUTT JOINT”.

HOT-MIX ASPHALT EQUIPMENT, SPREADING AND FINISHING MACHINE (BDE)

Effective: January 1, 2005

Revised: January 1, 2007

Revise the fourth paragraph of Article 1102.03 of the Standard Specifications to read:

“The paver shall be equipped with a receiving hopper having sufficient capacity for a uniform spreading operation. The hopper shall be equipped with a distribution system to uniformly place a non-segregated mixture in front of the screed. The distribution system shall have chain curtains, deflector plates, and /or other devices designed and built by the paver manufacturer to prevent segregation during distribution of the mixture from the hopper to the paver screed. The

Contractor shall submit a written certification that the devices recommended by the paver manufacturer to prevent segregation have been installed and are operational. Prior to paving, the Contractor, in the presence of the Engineer, shall visually inspect paver parts specifically identified by the manufacturer for excessive wear and the need for replacement. The Contractor shall supply a completed check list to the Engineer noting the condition of the parts. Worn parts shall be replaced. The Engineer may require an additional inspection prior to placement of the surface course or at other times throughout the work.”

HOT-MIX ASPHALT - FIELD VOIDS IN THE MINERAL AGGREGATE (BDE)

Effective: April 1, 2007

Add the following to the table in Article 1030.05(d)(2)a. of the Standard Specifications:

"Parameter	Frequency of Tests	Frequency of Tests	Test Method See Manual of Test Procedures for Materials
	High ESAL Mixture Low ESAL Mixture	All Other Mixtures	
VMA	1 per half day of production for first 2 days and 1 per day thereafter (first sample of the day)	1 per day	Illinois-Modified AASHTO R 35
Note 5.			

Note 5. The G_{sb} used in the voids in the mineral aggregate (VMA) calculation shall be the same average G_{sb} value listed in the mix design.”

Add the following to the Control Limits table in Article 1030.05(d)(4) of the Standard Specifications:

"CONTROL LIMITS			
Parameter	High ESAL Low ESAL	High ESAL Low ESAL	All Other
	Individual Test	Moving Avg. of 4	
VMA	-0.7 % ^{2/}	-0.5 % ^{2/}	N/A

2/ Allowable limit below minimum design VMA requirement”

Add the following to the table in Article 1030.05(d)(5) of the Standard Specifications:

"CONTROL CHART REQUIREMENTS	High ESAL Low ESAL	All Other
	VMA”	

Revise the heading of Article 1030.05(d)(6)a.1. of the Standard Specifications to read:

“1. Voids, VMA, and Asphalt Binder Content.”

Revise the first sentence of the first paragraph of Article 1030.05(d)(6)a.1.(a.) of the Standard Specifications to read:

“If the retest for voids, VMA, or asphalt binder content exceeds control limits, HMA production shall cease and immediate corrective action shall be instituted by the Contractor.”

Revise the table in Article 1030.05(e) of the Standard Specifications to read:

“Test Parameter	Acceptable Limits of Precision
% Passing: ^{1/}	
1/2 in. (12.5 mm)	5.0 %
No. 4 (4.75 mm)	5.0 %
No. 8 (2.36 mm)	3.0 %
No. 30 (600 μm)	2.0 %
Total Dust Content No. 200 (75 μm) ^{1/}	2.2 %
Asphalt Binder Content	0.3 %
Maximum Specific Gravity of Mixture	0.026
Bulk Specific Gravity	0.030
VMA	1.4 %
Density (% Compaction)	1.0 % (Correlated)

1/ Based on washed ignition.”

PAYMENTS TO SUBCONTRACTORS (BDE)

Effective: June 1, 2000

Revised: January 1, 2006

Federal regulations found at 49 CFR §26.29 mandate the Department to establish a contract clause to require Contractors to pay subcontractors for satisfactory performance of their subcontracts and to set the time for such payments.

State law also addresses the timing of payments to be made to subcontractors and material suppliers. Section 7 of the Prompt Payment Act, 30 ILCS 540/7, requires that when a Contractor receives any payment from the Department, the Contractor shall make corresponding, proportional payments to each subcontractor and material supplier performing work or supplying material within 15 calendar days after receipt of the Department payment. Section 7 of the Act further provides that interest in the amount of two percent per month, in

addition to the payment due, shall be paid to any subcontractor or material supplier by the Contractor if the payment required by the Act is withheld or delayed without reasonable cause. The Act also provides that the time for payment required and the calculation of any interest due applies to transactions between subcontractors and lower-tier subcontractors and material suppliers throughout the contracting chain.

This Special Provision establishes the required federal contract clause, and adopts the 15 calendar day requirement of the State Prompt Payment Act for purposes of compliance with the federal regulation regarding payments to subcontractors. This contract is subject to the following payment obligations.

When progress payments are made to the Contractor according to Article 109.07 of the Standard Specifications, the Contractor shall make a corresponding payment to each subcontractor and material supplier in proportion to the work satisfactorily completed by each subcontractor and for the material supplied to perform any work of the contract. The proportionate amount of partial payment due to each subcontractor and material supplier throughout the contracting chain shall be determined by the quantities measured or otherwise determined as eligible for payment by the Department and included in the progress payment to the Contractor. Subcontractors and material suppliers shall be paid by the Contractor within 15 calendar days after the receipt of payment from the Department. The Contractor shall not hold retainage from the subcontractors. These obligations shall also apply to any payments made by subcontractors and material suppliers to their subcontractors and material suppliers; and to all payments made to lower tier subcontractors and material suppliers throughout the contracting chain. Any payment or portion of a payment subject to this provision may only be withheld from the subcontractor or material supplier to whom it is due for reasonable cause.

This Special Provision does not create any rights in favor of any subcontractor or material supplier against the State or authorize any cause of action against the State on account of any payment, nonpayment, delayed payment, or interest claimed by application of the State Prompt Payment Act. The Department will not approve any delay or postponement of the 15 day requirement except for reasonable cause shown after notice and hearing pursuant to Section 7(b) of the State Prompt Payment Act. State law creates other and additional remedies available to any subcontractor or material supplier, regardless of tier, who has not been paid for work properly performed or material furnished. These remedies are a lien against public funds set forth in Section 23(c) of the Mechanics Lien Act, 770 ILCS 60/23(c), and a recovery on the Contractor's payment bond according to the Public Construction Bond Act, 30 ILCS 550.

RECLAIMED ASPHALT PAVEMENT (RAP) (BDE)

Effective: January 1, 2007

Revised: August 1, 2007

In Article 1030.02(g), delete the last sentence of the first paragraph in (Note 2).

Revise Section 1031 of the Standard Specifications to read:

"SECTION 1031. RECLAIMED ASPHALT PAVEMENT

1031.01 Description. Reclaimed asphalt pavement (RAP) is reclaimed asphalt pavement resulting from cold milling or crushing of an existing dense graded hot-mix asphalt (HMA) pavement. The Contractor shall supply written documentation that the RAP originated from routes or airfields under federal, state, or local agency jurisdiction.

1031.02 Stockpiles. The Contractor shall construct individual, sealed RAP stockpiles meeting one of the following definitions. No additional RAP shall be added to the pile after the pile has been sealed. Stockpiles shall be sufficiently separated to prevent intermingling at the base. Stockpiles shall be identified by signs indicating the type as listed below (i.e. "Homogeneous Surface").

Prior to milling, the Contractor shall request the District to provide verification of the quality of the RAP to clarify appropriate stockpile.

- (a) Homogeneous. Homogeneous RAP stockpiles shall consist of RAP from Class I, Superpave (High ESAL), HMA (High ESAL), or equivalent mixtures and represent:
1) the same aggregate quality, but shall be at least C quality; 2) the same type of crushed aggregate (either crushed natural aggregate, ACBF slag, or steel slag); 3) similar gradation; and 4) similar asphalt binder content. If approved by the Engineer, combined single pass surface/binder millings may be considered "homogenous" with a quality rating dictated by the lowest coarse aggregate quality present in the mixture.
- (b) Conglomerate 5/8. Conglomerate 5/8 RAP stockpiles shall consist of RAP from Class I, Superpave (High ESAL), HMA (High ESAL), or equivalent mixtures. The coarse aggregate in this RAP shall be crushed aggregate and may represent more than one aggregate type and/or quality but shall be at least C quality. This RAP may have an inconsistent gradation and/or asphalt binder content prior to processing. All conglomerate 5/8 RAP shall be processed prior to testing by crushing to where all RAP shall pass the 5/8 in. (16 mm) or smaller screen. Conglomerate 5/8 RAP stockpiles shall not contain steel slag or other expansive material as determined by the Department.
- (c) Conglomerate 3/8. Conglomerate 3/8 RAP stockpiles shall consist of RAP from Class I, Superpave (High ESAL), HMA (High ESAL), or equivalent mixtures. The coarse aggregate in this RAP shall be crushed aggregate and may represent more than one aggregate type and/or quality but shall be at least B quality. This RAP may have an inconsistent gradation and/or asphalt binder content prior to processing. All conglomerate 3/8 RAP shall be processed prior to testing by crushing to where all RAP shall pass the 3/8 in. (9.5 mm) or smaller screen. Conglomerate 3/8 RAP stockpiles shall not contain steel slag or other expansive material as determined by the Department.
- (d) Conglomerate "D" Quality (DQ). Conglomerate DQ RAP stockpiles shall consist of RAP from Class I, Superpave (High or Low ESAL), HMA (High or Low ESAL), or equivalent mixtures. The coarse aggregate in this RAP may be crushed or round but shall be at least D quality. This RAP may have an inconsistent gradation and/or asphalt binder content. Conglomerate DQ RAP stockpiles shall not contain steel slag or other expansive material as determined by the Department.

- (e) Non-Quality. RAP stockpiles that do not meet the requirements of the stockpile categories listed above shall be classified as “Non-Quality”.

RAP containing contaminants, such as earth, brick, sand, concrete, sheet asphalt, bituminous surface treatment (i.e. chip seal), pavement fabric, joint sealants, etc., will be unacceptable unless the contaminants are removed to the satisfaction of the Engineer. Sheet asphalt shall be stockpiled separately.

1031.03 Testing. When used in HMA, the RAP shall be sampled and tested either during or after stockpiling.

For testing during stockpiling, washed extraction samples shall be run at the minimum frequency of one sample per 500 tons (450 metric tons) for the first 2000 tons (1800 metric tons) and one sample per 2000 tons (1800 metric tons) thereafter. A minimum of five tests shall be required for stockpiles less than 4000 tons (3600 metric tons).

For testing after stockpiling, the Contractor shall submit a plan for approval to the District proposing a satisfactory method of sampling and testing the RAP pile either in-situ or by restockpiling. The sampling plan shall meet the minimum frequency required above and detail the procedure used to obtain representative samples throughout the pile for testing.

Before extraction, each field sample shall be split to obtain two samples of test sample size. One of the two test samples from the final split shall be labeled and stored for Department use. The Contractor shall extract the other test sample according to Department procedure. The Engineer reserves the right to test any sample (split or Department-taken) to verify Contractor test results.

- (a) Testing Conglomerate 3/8. In addition to the requirements above, conglomerate 3/8 RAP shall be tested for maximum theoretical specific gravity (G_{mm}) at a frequency of one sample per 500 tons (450 metric tons) for the first 2000 tons (1800 metric tons) and one sample per 2000 tons (1800 metric tons) thereafter. A minimum of five tests shall be required for stockpiles less than 4000 tons (3600 metric tons).
- (b) Evaluation of Test Results. All of the extraction results shall be compiled and averaged for asphalt binder content and gradation and, when applicable G_{mm} . Individual extraction test results, when compared to the averages, will be accepted if within the tolerances listed below.

Parameter	Homogeneous / Conglomerate	Conglomerate "D" Quality
1 in. (25 mm)		± 5 %
1/2 in. (12.5 mm)	± 8 %	± 15 %
No. 4 (4.75 mm)	± 6 %	± 13 %
No. 8 (2.36 mm)	± 5 %	
No. 16 (1.18 mm)		± 15 %
No. 30 (600 μm)	± 5 %	
No. 200 (75 μm)	± 2.0 %	± 4.0 %
Asphalt Binder	± 0.4 % ^{1/}	± 0.5 %
G _{mm}	± 0.02 ^{2/}	

1/ The tolerance for conglomerate 3/8 shall be ± 0.3 %.

2/ Applies only to conglomerate 3/8. When variation of the G_{mm} exceeds the ± 0.02 tolerance, a new conglomerate 3/8 stockpile shall be created which will also require an additional mix design.

If more than 20 percent of the individual sieves are out of the gradation tolerances, or if more than 20 percent of the asphalt binder content test results fall outside the appropriate tolerances, the RAP shall not be used in HMA unless the RAP representing the failing tests is removed from the stockpile. All test data and acceptance ranges shall be sent to the District for evaluation.

With the approval of the Engineer, the ignition oven may be substituted for extractions according to the Illinois Test Procedure, "Calibration of the Ignition Oven for the Purpose of Characterizing Reclaimed Asphalt Pavement (RAP)".

1031.04 Quality Designation of Aggregate in RAP. The quality of the RAP shall be set by the lowest quality of coarse aggregate in the RAP stockpile and are designated as follows.

- (a) RAP from Class I, Superpave (High ESAL), or HMA (High ESAL) surface mixtures are designated as containing Class B quality coarse aggregate.
- (b) RAP from Superpave (Low ESAL)/HMA (Low ESAL) IL-19.0L binder and IL-9.5L surface mixtures are designated as Class D quality coarse aggregate.
- (c) RAP from Class I, Superpave (High ESAL), or HMA (High ESAL) binder mixtures, bituminous base course mixtures, and bituminous base course widening mixtures are designated as containing Class C quality coarse aggregate.
- (d) RAP from bituminous stabilized subbase and BAM shoulders are designated as containing Class D quality coarse aggregate.

1031.05 Use of RAP in HMA. The use of RAP in HMA shall be as follows.

- (a) Coarse Aggregate Size. The coarse aggregate in all RAP shall be equal to or less than the nominal maximum size requirement for the HMA mixture to be produced.
- (b) Steel Slag Stockpiles. RAP stockpiles containing steel slag or other expansive material, as determined by the Department, shall be homogeneous and will be approved for use in HMA (High ESAL and Low ESAL) surface mixtures only.
- (c) Use in HMA Surface Mixtures (High and Low ESAL). RAP stockpiles for use in HMA surface mixtures (High and Low ESAL) shall be either homogeneous or conglomerate 3/8, in which the coarse aggregate is Class B quality or better.
- (d) Use in HMA Binder Mixtures (High and Low ESAL), HMA Base Course, and HMA Base Course Widening. RAP stockpiles for use in HMA binder mixtures (High and Low ESAL), HMA base course, and HMA base course widening shall be homogeneous, conglomerate 5/8, or conglomerate 3/8, in which the coarse aggregate is Class C quality or better.
- (e) Use in Shoulders and Subbase. RAP stockpiles for use in HMA shoulders and stabilized subbase (HMA) shall be homogeneous, conglomerate 5/8, conglomerate 3/8, or conglomerate DQ.
- (f) The use of RAP shall be a contractor's option when constructing HMA in all contracts. When the contractor chooses the RAP option, the percentage of RAP shall not exceed the amounts indicated in the table for a given N Design.

Max RAP Percentage

HMA MIXTURES ^{1/, 3/}	MAXIMUM % RAP		
	Binder/Leveling Binder	Surface	Polymer Modified
Ndesign			
30	30	30	10
50	25	15	10
70	15 / 25 ^{2/}	10 / 15 ^{2/}	10
90	10	10	10
105	10	10	10

1/ For HMA Shoulder and Stabilized Sub-Base (HMA) N-30, the amount of RAP shall not exceed 50% of the mixture.

2/ Value of Max % RAP if 3/8 RAP is utilized.

3/ When RAP exceeds 20%, the high & low virgin asphalt binder grades shall each be reduced by one grade (i.e. 25% RAP would require a virgin asphalt binder grade of PG64-22 to be reduced to a PG58-28).

1031.06 HMA Mix Designs. At the Contractor's option, HMA mixtures may be constructed utilizing RAP material meeting the above detailed requirements.

RAP designs shall be submitted for volumetric verification. If additional RAP stockpiles are tested and found that no more than 20 percent of the results, as defined under "Testing" herein, are outside of the control tolerances set for the original RAP stockpile and HMA mix design, and meets all of the requirements herein, the additional RAP stockpiles may be used in the original mix design at the percent previously verified.

1031.07 HMA Production. The coarse aggregate in all RAP used shall be equal to or less than the nominal maximum size requirement for the HMA mixture being produced.

To remove or reduce agglomerated material, a scalping screen, crushing unit, or comparable sizing device approved by the Engineer shall be used in the RAP feed system to remove or reduce oversized material. If material passing the sizing device adversely affects the mix production or quality of the mix, the sizing device shall be set at a size specified by the Engineer.

If the RAP control tolerances or QC/QA test results require corrective action, the Contractor shall cease production of the mixture containing RAP and either switch to the virgin aggregate design or submit a new RAP design. When producing mixtures containing conglomerate 3/8 RAP, a positive dust control system shall be utilized.

HMA plants utilizing RAP shall be capable of automatically recording and printing the following information.

(a) Dryer Drum Plants.

- (1) Date, month, year, and time to the nearest minute for each print.
- (2) HMA mix number assigned by the Department.
- (3) Accumulated weight of dry aggregate (combined or individual) in tons (metric tons) to the nearest 0.1 ton (0.1 metric ton).
- (4) Accumulated dry weight of RAP in tons (metric tons) to the nearest 0.1 ton (0.1 metric ton).
- (5) Accumulated mineral filler in revolutions, tons (metric tons), etc. to the nearest 0.1 unit.
- (6) Accumulated asphalt binder in gallons (liters), tons (metric tons), etc. to the nearest 0.1 unit.
- (7) Residual asphalt binder in the RAP material as a percent of the total mix to the nearest 0.1 percent.

(8) Aggregate and RAP moisture compensators in percent as set on the control panel. (Required when accumulated or individual aggregate and RAP are printed in wet condition.)

(b) Batch Plants.

(1) Date, month, year, and time to the nearest minute for each print.

(2) HMA mix number assigned by the Department.

(3) Individual virgin aggregate hot bin batch weights to the nearest pound (kilogram).

(4) Mineral filler weight to the nearest pound (kilogram).

(5) RAP weight to the nearest pound (kilogram).

(6) Virgin asphalt binder weight to the nearest pound (kilogram).

(7) Residual asphalt binder in the RAP material as a percent of the total mix to the nearest 0.1 percent.

The printouts shall be maintained in a file at the plant for a minimum of one year or as directed by the Engineer and shall be made available upon request. The printing system will be inspected by the Engineer prior to production and verified at the beginning of each construction season thereafter.

1031.08 RAP in Aggregate Surface Course and Aggregate Shoulders. The use of RAP in aggregate surface course and aggregate shoulders shall be as follows.

(a) Stockpiles and Testing. RAP stockpiles may be any of those listed in Article 1031.02, except "Other". The testing requirements of Article 1031.03 shall not apply.

(b) Gradation. One hundred percent of the RAP material shall pass the 1 1/2 in. (37.5 mm) sieve. The RAP material shall be reasonably well graded from coarse to fine. RAP material that is gap-graded or single sized will not be accepted."

REFLECTIVE SHEETING ON CHANNELIZING DEVICES (BDE)

Effective: April 1, 2007

Revise the seventh paragraph of Article 1106.02 of the Standard Specifications to read:

"At the time of manufacturing, the retroreflective prismatic sheeting used on channelizing devices shall meet or exceed the initial minimum coefficient of retroreflection as specified in the following table. Measurements shall be conducted according to ASTM E 810, without averaging. Sheeting used on cones, drums and flexible delineators shall be reboundable as tested according to ASTM D 4956. Prestriped sheeting for rigid substrates on barricades shall be white and orange.

Initial Minimum Coefficient of Retroreflection candelas/foot candle/sq ft (candelas/lux/sq m) of material				
Observation Angle (deg.)	Entrance Angle (deg.)	White	Orange	Fluorescent Orange
0.2	-4	365	160	150
0.2	+30	175	80	70
0.5	-4	245	100	95
0.5	+30	100	50	40"

Revise the first sentence of the first paragraph of Article 1106.02(c) of the Standard Specifications to read:

“Barricades and vertical panels shall have alternating white and orange stripes sloping downward at 45 degrees toward the side on which traffic will pass.”

Revise the third sentence of the first paragraph of Article 1106.02(d) of the Standard Specifications to read:

“The bottom panels shall be 8 x 24 in. (200 x 600 mm) with alternating white and orange stripes sloping downward at 45 degrees toward the side on which traffic will pass.”

STONE GRADATION TESTING (BDE)

Effective: November 1, 2007

Revise the first sentence of note 1/ of the Erosion Protection and Sediment Control Gradations table of Article 1005.01(c)(1) of the Standard Specifications to read:

“A maximum of 15 percent of the total test sample by weight may be oversize material.”

SUBCONTRACTOR MOBILIZATION PAYMENTS (BDE)

Effective: April 2, 2005

To account for the preparatory work and operations necessary for the movement of subcontractor personnel, equipment, supplies, and incidentals to the project site and for all other work or operations that must be performed or costs incurred when beginning work approved for subcontracting in accordance with Article 108.01 of the Standard Specifications, the Contractor shall make a mobilization payment to each subcontractor.

This mobilization payment shall be made at least 14 days prior to the subcontractor starting work. The amount paid shall be equal to 3 percent of the amount of the subcontract reported on form BC 260A submitted for the approval of the subcontractor’s work.

This provision shall be incorporated directly or by reference into each subcontract approved by the Department.

THERMOPLASTIC PAVEMENT MARKINGS (BDE)

Effective: January 1, 2007

Revise Article 1095.01(a)(2) of the Standard Specifications to read:

“(2) Pigment. The pigment used for the white thermoplastic compound shall be a high-grade pure (minimum 93 percent) titanium dioxide (TiO₂). The white pigment content shall be a minimum of ten percent by weight and shall be uniformly distributed throughout the thermoplastic compound.

The pigments used for the yellow thermoplastic compound shall not contain any hazardous materials listed in the Environmental Protection Agency Code of Federal Regulations (CFR) 40, Section 261.24, Table 1. The combined total of RCRA listed heavy metals shall not exceed 100 ppm when tested by X-ray fluorescence spectroscopy. The pigments shall also be heat resistant, UV stable and color-fast yellows, golds, and oranges, which shall produce a compound which shall match Federal Standard 595 Color No. 33538. The pigment shall be uniformly distributed throughout the thermoplastic compound.”

Revise Article 1095.01(b)(1)e. of the Standard Specifications to read:

“e. Daylight Reflectance and Color. The thermoplastic compound after heating for four hours ± five minutes at 425 ± 3 °F (218.3 ± 2 °C) and cooled at 77 °F (25 °C) shall meet the following requirements for daylight reflectance and color, when tested, using a color spectrophotometer with 45 degree circumferential/zero degree geometry, illuminant C, and two degree observer angle. The color instrument shall measure the visible spectrum from 380 to 720 nm with a wavelength measurement interval and spectral bandpass of 10 nm.

White: Daylight Reflectance75 percent min.

*Yellow: Daylight Reflectance45 percent min.

*Shall meet the coordinates of the following color tolerance chart.

x	0.490	0.475	0.485	0.530
y	0.470	0.438	0.425	0.456”

Revise Article 1095.01(b)(1)k. of the Standard Specifications to read:

“k. Accelerated Weathering. After heating the thermoplastic for four hours ± five minutes at 425 ± 3 °F (218.3 ± 2 °C) the thermoplastic shall be applied to a steel wool abraded aluminum alloy panel (Federal Test Std. No. 141, Method 2013) at a film thickness of 30 mils (0.70 mm) and allowed to cool for 24 hours at room

temperature. The coated panel shall be subjected to accelerated weathering using the light and water exposure apparatus (fluorescent UV - condensation type) for 75 hours according to ASTM G 53 (equipped with UVB-313 lamps).

The cycle shall consist of four hours UV exposure at 122 °F (50 °C) followed by four hours of condensation at 104 °F (40 °C). UVB 313 bulbs shall be used. At the end of the exposure period, the panel shall not exceed 10 Hunter Lab Delta E units from the original material.”

WORKING DAYS (BDE)

Effective: January 1, 2002

The Contractor shall complete the work within 55 working days.

BITUMINOUS MATERIALS COST ADJUSTMENTS (BDE) (RETURN FORM WITH BID)

Effective: November 2, 2006

Revised: January 2, 2007

Description. For projects with at least 1200 tons (1100 metric tons) of work involving applicable bituminous materials, cost adjustments will be made to provide additional compensation to the Contractor, or credit to the Department, for fluctuations in the cost of bituminous materials when optioned by the Contractor. The adjustments shall apply to permanent and temporary hot-mix asphalt (HMA) mixtures, bituminous surface treatments (cover and seal coats), and pavement preservation type surface treatments. The adjustments shall not apply to bituminous prime coats, tack coats, crack filling/sealing, or joint filling/sealing.

The bidder shall indicate on the attached form whether or not this special provision will be part of the contract and submit the completed form with his/her bid. Failure to submit the form, or failure to fill out the form completely, shall make this contract exempt of bituminous materials cost adjustments.

Method of Adjustment. Bituminous materials cost adjustments will be computed as follows.

$$CA = (BPI_P - BPI_L) \times (\%AC_V / 100) \times Q$$

Where: CA = Cost Adjustment, \$.

BPI_P = Bituminous Price Index, as published by the Department for the month the work is performed, \$/ton (\$/metric ton).

BPI_L = Bituminous Price Index, as published by the Department for the month prior to the letting, \$/ton (\$/metric ton).

%AC_V = Percent of virgin Asphalt Cement in the Quantity being adjusted. For HMA mixtures, the % AC_V will be determined from the adjusted job mix formula. For bituminous materials applied, a performance graded or cutback asphalt will be considered to be 100% AC_V and undiluted emulsified asphalt will be considered to be 65% AC_V.

Q = Authorized construction Quantity, tons (metric tons) (see below).

For HMA mixtures measured in square yards: $Q, \text{ tons} = A \times D \times (G_{mb} \times 46.8) / 2000$. For HMA mixtures measured in square meters: $Q, \text{ metric tons} = A \times D \times (G_{mb} \times 24.99) / 1000$. When computing adjustments for full-depth HMA pavement, separate calculations will be made for the binder and surface courses to account for their different G_{mb} and % AC_v.

For bituminous materials measured in gallons: $Q, \text{ tons} = V \times 8.33 \text{ lb/gal} \times SG / 2000$

For bituminous materials measured in liters: $Q, \text{ metric tons} = V \times 1.0 \text{ kg/L} \times SG / 1000$

Where: A = Area of the HMA mixture, sq yd (sq m).
D = Depth of the HMA mixture, in. (mm).
 G_{mb} = Average bulk specific gravity of the mixture, from the approved mix design.
V = Volume of the bituminous material, gal (L).
SG = Specific Gravity of bituminous material as shown on the bill of lading.

Basis of Payment. Bituminous materials cost adjustments may be positive or negative but will only be made when there is a difference between the BPI_L and BPI_P in excess of five percent, as calculated by:

$$\text{Percent Difference} = \{(BPI_L - BPI_P) \div BPI_L\} \times 100$$

Bituminous materials cost adjustments will be calculated for each calendar month in which applicable bituminous material is placed; and will be paid or deducted when all other contract requirements for the items of work are satisfied. The adjustments shall not apply during contract time subject to liquidated damages for completion of the entire contract.

Return With Bid

**ILLINOIS DEPARTMENT
OF TRANSPORTATION**

**OPTION FOR
BITUMINOUS MATERIALS COST ADJUSTMENTS**

The bidder shall submit this completed form with his/her bid. Failure to submit the form, or failure to fill out the form completely, shall make this contract exempt of bituminous materials cost adjustments. After award, this form, when submitted, shall become part of the contract.

Contract No.: _____

Company Name: _____

Contractor's Option:

Is your company opting to include this special provision as part of the contract?

Yes No

Signature: _____ **Date:** _____

STEEL COST ADJUSTMENT (BDE) (RETURN FORM WITH BID)

Effective: April 2, 2004

Revised: April 1, 2007

Description. Steel cost adjustments will be made to provide additional compensation to the Contractor, or a credit to the Department, for fluctuations in steel prices when optioned by the Contractor. The bidder shall indicate on the attached form whether or not this special provision will be part of the contract and submit the completed form with his/her bid. Failure to submit the form, or failure to fill out the form completely, shall make this contract exempt of steel cost adjustments.

Types of Steel Products. An adjustment will be made for fluctuations in the cost of steel used in the manufacture of the following items:

- Metal Piling (excluding temporary sheet piling)
- Structural Steel
- Reinforcing Steel

Other steel materials such as dowel bars, tie bars, mesh reinforcement, guardrail, steel traffic signal and light poles, towers and mast arms, metal railings (excluding wire fence), frames and grates, and other miscellaneous items will be subject to a steel cost adjustment when the pay item they are used in has a contract value of \$10,000 or greater.

Documentation. Sufficient documentation shall be furnished to the Engineer to verify the following:

- (a) Evidence that increased or decreased steel costs have been passed on to the Contractor.
- (b) The dates and quantity of steel, in lb (kg), shipped from the mill to the fabricator.
- (c) The quantity of steel, in lb (kg), incorporated into the various items of work covered by this special provision. The Department reserves the right to verify submitted quantities.

Method of Adjustment. Steel cost adjustments will be computed as follows:

$$SCA = Q \times D$$

Where: SCA = steel cost adjustment, in dollars
Q = quantity of steel incorporated into the work, in lb (kg)
D = price factor, in dollars per lb (kg)

$$D = CBP_M - CBP_L$$

Where: CBP_M = The average of the Consumer Buying Price indices for Shredded Auto Scrap (Chicago) and No. 1 Heavy Melt (Chicago) as published by the American Metal Market (AMM) for the day the steel is shipped from the mill. The indices will be converted from dollars per ton to dollars per lb (kg).

CBP_L = The average of the Consumer Buying Price indices for Shredded Auto Scrap (Chicago) and No. 1 Heavy Melt (Chicago) as published by the AMM for the day the contract is let. The indices will be converted from dollars per ton to dollars per lb (kg).

The unit weights (masses) of steel that will be used to calculate the steel cost adjustment for the various items are shown in the attached table.

No steel cost adjustment will be made for any products manufactured from steel having a mill shipping date prior to the letting date.

If the Contractor fails to provide the required documentation, the method of adjustment will be calculated as described above; however, the CBP_M will be based on the date the steel arrives at the job site. In this case, an adjustment will only be made when there is a decrease in steel costs.

Basis of Payment. Steel cost adjustments may be positive or negative but will only be made when there is a difference between the CBP_L and CBP_M in excess of five percent, as calculated by:

$$\text{Percent Difference} = \{(CBP_L - CBP_M) \div CBP_L\} \times 100$$

Steel cost adjustments will be calculated by the Engineer and will be paid or deducted when all other contract requirements for the items of work are satisfied. Adjustments will only be made for fluctuations in the cost of the steel as described herein. No adjustment will be made for changes in the cost of manufacturing, fabrication, shipping, storage, etc.

The adjustments shall not apply during contract time subject to liquidated damages for completion of the entire contract.

Attachment

Item	Unit Mass (Weight)
Metal Piling (excluding temporary sheet piling)	
Furnishing Metal Pile Shells 12 in. (305 mm), 0.179 in. (3.80 mm) wall thickness)	23 lb/ft (34 kg/m)
Furnishing Metal Pile Shells 12 in. (305 mm), 0.250 in. (6.35 mm) wall thickness)	32 lb/ft (48 kg/m)
Furnishing Metal Pile Shells 14 in. (356 mm), 0.250 in. (6.35 mm) wall thickness)	37 lb/ft (55 kg/m)
Other piling	See plans
Structural Steel	See plans for weights (masses)
Reinforcing Steel	See plans for weights (masses)
Dowel Bars and Tie Bars	6 lb (3 kg) each
Mesh Reinforcement	63 lb/100 sq ft (310 kg/sq m)
Guardrail	
Steel Plate Beam Guardrail, Type A w/steel posts	20 lb/ft (30 kg/m)
Steel Plate Beam Guardrail, Type B w/steel posts	30 lb/ft (45 kg/m)
Steel Plate Beam Guardrail, Types A and B w/wood posts	8 lb/ft (12 kg/m)
Steel Plate Beam Guardrail, Type 2	305 lb (140 kg) each
Steel Plate Beam Guardrail, Type 6	1260 lb (570 kg) each
Traffic Barrier Terminal, Type 1 Special (Tangent)	730 lb (330 kg) each
Traffic Barrier Terminal, Type 1 Special (Flared)	410 lb (185 kg) each
Steel Traffic Signal and Light Poles, Towers and Mast Arms	
Traffic Signal Post	11 lb/ft (16 kg/m)
Light Pole, Tenon Mount and Twin Mount, 30 - 40 ft (9 - 12 m)	14 lb/ft (21 kg/m)
Light Pole, Tenon Mount and Twin Mount, 45 - 55 ft (13.5 - 16.5 m)	21 lb/ft (31 kg/m)
Light Pole w/Mast Arm, 30 - 50 ft (9 - 15.2 m)	13 lb/ft (19 kg/m)
Light Pole w/Mast Arm, 55 - 60 ft (16.5 - 18 m)	19 lb/ft (28 kg/m)
Light Tower w/Luminaire Mount, 80 - 110 ft (24 - 33.5 m)	31 lb/ft (46 kg/m)
Light Tower w/Luminaire Mount, 120 - 140 ft (36.5 - 42.5 m)	65 lb/ft (97 kg/m)
Light Tower w/Luminaire Mount, 150 - 160 ft (45.5 - 48.5 m)	80 lb/ft (119 kg/m)
Metal Railings (excluding wire fence)	
Steel Railing, Type SM	64 lb/ft (95 kg/m)
Steel Railing, Type S-1	39 lb/ft (58 kg/m)
Steel Railing, Type T-1	53 lb/ft (79 kg/m)
Steel Bridge Rail	52 lb/ft (77 kg/m)
Frames and Grates	
Frame	250 lb (115 kg)
Lids and Grates	150 lb (70 kg)

Return With Bid

**ILLINOIS DEPARTMENT
OF TRANSPORTATION**

**OPTION FOR
STEEL COST ADJUSTMENT**

The bidder shall submit this completed form with his/her bid. Failure to submit the form, or failure to fill out the form completely, shall make this contract exempt of steel cost adjustments. After award, this form, when submitted shall become part of the contract.

Contract No.: _____

Company Name: _____

Contractor's Option:

Is your company opting to include this special provision as part of the contract plans?

Yes No

Signature: _____ **Date:** _____

SQUAD LEADER:
CHRIS AUDE

PROJECT ENGINEER:
BOB WAGNER

(815) 284-5358

STATE OF ILLINOIS
DEPARTMENT OF TRANSPORTATION
PROPOSED HIGHWAY PLANS

FAP ROUTE 309 (US 30)
D2 SPRING RS 2007-2
WHITESIDE COUNTY

C-92-100-07

D-92-076-07

FAP Route 309 (US 30)
D2 SPRING RS 2007-2
Whiteside County
Contract #64D31
Sheet 1 of 38

Index of Sheets & State Standards
See sheet No. 2

ADT = 8900
PV = 7600
SU = 450
MU = 850

T. 21 N.

SECTION BEGINS
Station 174+20

BRIDGE OMISSION
Station 425+61 - 427+31

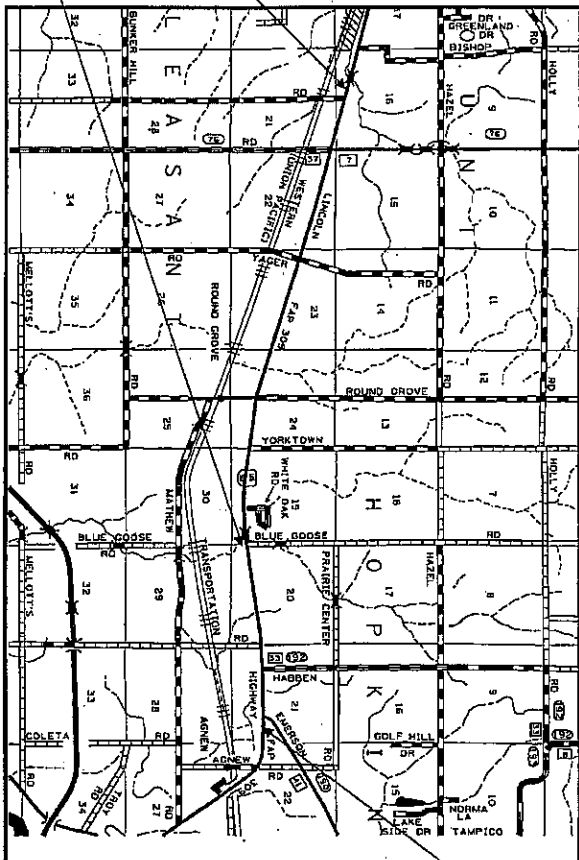

SECTION ENDS
Station 507+30

TOWNSHIP (SECTION): PLEASANT (16,21,22,23,24)
HOPKINS (19,20,21)

R. 5 E.

R. 6 E.

CALL J.U.L.I.E. BEFORE YOU DIG
800-892-0123

GROSS LENGTH OF SECTION = 33355' = 6.32 MILES
NET LENGTH OF SECTION = 33185' = 6.29 MILES

CONTRACT # 64D31

STATE OF ILLINOIS DEPARTMENT OF TRANSPORTATION DIVISION OF HIGHWAYS	
SUBMITTED	8/13, 2007
DEPUTY DIRECTOR OF HIGHWAYS/REGION ENGINEER	
ENGINEER OF DESIGN AND ENVIRONMENT	_____ 20__
DIRECTOR OF HIGHWAYS, CHIEF ENGINEER	_____ 20__
DISTRICT 2 DIXON, IL.	

PRINTED BY THE AUTHORITY OF THE STATE OF ILLINOIS

INDEX OF SHEETS

1	COVER SHEET
2	INDEX AND STANDARDS
3-5	SUMMARY OF QUANTITIES
6-7	GENERAL NOTES
8-18	TYPICAL SECTIONS
19	BITUMINOUS SCHEDULE
20-21	SIDE ROAD AND DRIVEWAY SCHEDULE
22-23	PARTIAL DEPTH PATCHING SCHEDULE
24-29	SCHEDULE OF QUANTITIES
30	HOT-MIX ASPHALT SHOULDERS (23.4a)
31	PAVEMENT PATCHING FOR HOT-MIX ASPHALT SURFACED PAVEMENT (32.4)
32	AERIAL SPEED CHECK ZONES (46.4)
33	SUBGRADE REPLACEMENT (97.4)
34	HOT-MIX ASPHALT APPROACHES AND MAILBOX RETURNS FOR TWO LIFT (3P) RESURFACING PROJECTS (47.2)
35	ROUGH GROOVED SURFACE SIGN (91.2)
36	HOT-MIX ASPHALT APPROACHES & MAILBOX RETURNS (20.1)
37-38	TYPICAL PAVEMENT MARKINGS (41.1)

STANDARDS

000001-04	STANDARD SYMBOLS, ABBRECIATIONS AND PATTERNS
001006	DECIMAL OF AN INCH AND OF A FOOT
420701-01	PAVEMENT FABRIC
442101-06	CLASS B PATCHES
482011-02	HMA SHOULDER STRIPS/SHOULDERS WITH RESURFACING OR WIDENING AND RESURFACING PROJECTS
701006-02	OFF-ROAD OPERATIONS, 2L, 2W, 4.5m (15') TO 600mm (24") FROM PAVEMENT EDGE
701011-01	OFF-ROAD MOVING OPERATIONS, 2L, 2W, DAY ONLY
701201-02	LANE CLOSURE, 2L, 2W, DAY ONLY, FOR SPEEDS ≥ 45 MPH
701306-01	LANE CLOSURE, 2L, 2W, SLOW MOVING OPERATIONS DAY ONLY, FOR SPEEDS ≥ 45 MPH
701311-02	LANE CLOSURE, 2L, 2W, MOVING OPERATIONS - DAY ONLY
701326-02	LANE CLOSURE, 2L, 2W, PAVEMENT WIDENING, FOR SPEEDS > 45 MPH
702001-06	TRAFFIC CONTROL DEVICES
720011	METAL POSTS FOR SIGNS, MARKERS & DELINEATORS
728001	TELESCOPING STEEL SIGN SUPPORT
729001	APPLICATIONS OF TYPES A AND B METAL POST (FOR SIGNS & MARKERS)
780001-01	TYPICAL PAVEMENT MARKINGS
781001-02	TYPICAL APPLICATIONS RAISED REFLECTIVE PAVEMENT MARKERS

SUMMARY OF QUANTITIES

FAP Route 309 (US 30)
 D2 SPRING RS 2007-2
 Whiteside County
 Contract #64D31
 Sheet 3 of 38

100% State
 1000

CODE NO.	ITEM	UNIT	STATE QUANTITY
20200600	EXCAVATING AND GRADING EXISTING SHOULDER	UNIT	587
35101400	AGGREGATE BASE COURSE, TYPE B	TON	541
40600200	BITUMINOUS MATERIALS (PRIME COAT)	TON	60
40600300	AGGREGATE(PRIME COAT)	TON	146
40600535	LEVELING BINDER (HAND METHOD), N70	TON	60
40600637	LEVEL BINDER (MACHINE METHOD), IL-9.5FG, N70	TON	6749
40600895	CONSTRUCTING TEST STRIP	EACH	1
40600982	HOT- MIX ASPHALT SURFACE REMOVAL- BUTT JOINT	SQ YD	1150
40600990	TEMPORARY RAMP	SQ YD	235
40601005	HOT- MIX ASPHALT REPLACEMENT OVER PATCHES	TON	162
40603310	HOT- MIX ASPHALT SURFACE COURSE, MIX "C", N50	TON	209
40603340	HOT- MIX ASPHALT SURFACE COURSE, MIX "D", N70	TON	8158
40800050	INCIDENTAL HOT- MIX ASPHALT SURFACING	TON	1552
42001200	PAVEMENT FABRIC	SQ YD	52
44000158	HOT- MIX ASPHALT SURFACE REMOVAL, 2 1/4"	SQ YD	9172

SUMMARY OF QUANTITIES

FAP Route 309 (US 30)
D2 SPRING RS 2007-2

Whiteside County
Contract #64D31
Sheet 4 of 38

100% State
1000

CODE NO.	ITEM	UNIT	STATE QUANTITY
44002210	HOT-MIX ASPHALT REMOVAL OVER PATCHES, 2 1/2"	SQ YD	1159
44200970	CLASS B PATCHES, TYPE II, 10 INCH	SQ YD	76
44200974	CLASS B PATCHES, TYPE III, 10 INCH	SQ YD	20
44200976	CLASS B PATCHES, TYPE IV, 10 INCH	SQ YD	32
44213200	SAW CUTS	FOOT	630
48102100	AGGREGATE WEDGE SHOULDERS, TYPE B	TON	8629
67100100	MOBILIZATION	L SUM	1
70100450	TRAFFIC CONTROL AND PROTECTION, STANDARD 701201	L SUM	1
70100460	TRAFFIC CONTROL AND PROTECTION, STANDARD 701306	L SUM	1
70100500	TRAFFIC CONTROL AND PROTECTION, STANDARD 701326	L SUM	1
70300100	SHORT-TERM PAVEMENT MARKING	FOOT	10288
70301000	WORK ZONE PAVEMENT MARKING REMOVAL	SQ FT	1113
78000100	THERMOPLASTIC PAVEMENT MARKING - LETTERS AND SYMBOLS	SQ FT	140
78000500	THERMOPLASTIC PAVEMENT MARKING - LINE 8"	FOOT	745

* SPECIALTY ITEM

SUMMARY OF QUANTITIES

FAP Route 309 (US 30)
 D2 SPRING RS 2007-2
 Whiteside County
 Contract #64D31
 Sheet 5 of 38

100% State
 1000

CODE NO.	ITEM	UNIT	STATE QUANTITY
* 78000600	THERMOPLASTIC PAVEMENT MARKING - LINE 12"	FOOT	104
* 78000620	THERMOPLASTIC PAVEMENT MARKING - LINE 18"	FOOT	36
* 78000650	THERMOPLASTIC PAVEMENT MARKING - LINE 24"	FOOT	50
* 78001110	PAINT PAVEMENT MARKING - LINE 4"	FOOT	169078
* 78100100	RAISED REFLECTIVE PAVEMENT MARKER	EACH	437
78300200	RAISED REFLECTIVE PAVEMENT MARKER REMOVAL	EACH	412
Z0017100	DOWEL BARS	EACH	240
Z0028415	GEOTECHNICAL REINFORCEMENT	SQ YD	1188
Z0028700	GRANULAR SUBGRADE REPLACEMENT	CU YD	198
Z0040315	PILOT CAR	DAY	5
Z0075300	TIE BARS	EACH	13

* Specialty Items

GENERAL NOTES

Closed expansion joints on jointed pavements shall be re-established during the patching operations. Class B Patches - When the pavement requires patching at the location of the expansion joint, a new joint should be established using a dowelled expansion patch as shown on Highway Standard 442101. When the joint is closed, but does not require patching, an expansion joint may be formed by sawing the pavement and filling the saw cut with a preformed expansion joint filler meeting the requirements of Section 1051 of the Standard Specifications as shown on Standard 420001.

When laying out for patching, the minimum distance between new patches (saw cut to saw cut) shall be 4.6 m (15 feet). When patch spacing is less than 4.6 m (15 feet), the pavement between patches shall also be removed and replaced.

All mandatory joint sealing for Class A, Class B, and Class B (Hinge Jointed) patches as shown on the plans will not be measured for payment. Optional sawing of the joint for the sealant reservoir will not be measured for payment.

For all concrete patching that will not be resurfaced, the concrete shall be struck off flush with the existing pavement surface at each end of the patch.

The Engineer reserves the right to check all patches for smoothness by the use of a 10' rolling straight edge set to a 3/16" tolerance in the wheel paths. Any patch areas higher than 3/16" must be ground smooth with an approved grinding device consisting of multiple saws. The use of bushhammer or other impact devices will not be permitted. Any patch with depressions greater than 3/16" shall be repaired in a manner approved by the Engineer.

The mandatory saw cuts for pavement patching are:

Class A Patch: Cut two transverse saw cuts at each end of the patch; one full depth and one partial depth. The longitudinal edges of the patch shall be cut full depth. When the patch is adjacent to a pcc shoulder, two saw cuts along the shoulder will be required.

Class B Patch: Cut two transverse saw cuts outlining the patch and one transverse pressure relief saw cut. The longitudinal edges of the patch shall be cut full depth. When the patch is adjacent to a pcc shoulder, two saw cuts along the shoulder will be required.

The mandatory saw cuts will be paid for at the contract unit price per Meter (Foot) for SAW CUTS.

The minimum patch dimension for full-depth patches will be 1.2 m (four feet) and half-lane width. Half-lane patches shall be confined to the outside edges of the pavement.

The existing hot-mix asphalt surface on private and commercial entrances shall be bladed off or milled and disposed of outside the project limits. The cost of the blading, milling, rolling, and disposal is included in the contract unit price for INCIDENTAL HOT-MIX ASPHALT SURFACING.

Milling machines on this project shall be capable of removing a layer of bituminous a minimum 6" wide and 1-1/2 inches in depth in a single pass.

The following Mixture Requirements are applicable for this project:

Mixture Uses(s):	Surface Course	Level Binder	Top Shoulder	Binder for Patches
PG:	PG 64-22	PG 64-22	PG 58-22	PG 64-22
Design Air Voids	4.0 @ N70	4.0 @ N70	3.0 @ N50	4.0 @ N70
Mixture Composition (Gradation Mixture)	IL 9.5 or 12.5	IL 9.5 FG	IL 9.5 or 12.5	IL 19.0
Friktion Aggregate	D	N/A	C	N/A
20 Year ESAL	4.8	4.8	N/A	4.8

The Contractor will be required to furnish 140 mm (5 1/2") high brass stencils as approved by the Engineer and install stationing at 250' intervals. Stationing shall be placed on both lanes of 2-lane highways and on the outside lanes in both directions on 4-lane highways. The stations shall be placed 150 mm (6") inside the pavement marking edge so they can be read from the shoulder. This work will be included in the cost of the final pavement surface.

To help avoid excess drop offs at the edge of pavement, the existing aggregate wedge or shoulder is to be pulled up and rolled to match the edge of pavement before placing any bituminous material. All costs associated with pulling up the shoulders shall be considered included in the contract unit price per TON for HOT-MIX ASPHALT SURFACE COURSE of the type specified.

If, during the grinding or resurfacing operations, the existing mailboxes become a hindrance, the Contractor shall be required to carefully remove and reinstall the mailboxes as directed by the Engineer. This work shall be included in the contract unit price for the INCIDENTAL HOT-MIX SURFACING.

Pavement Marking shall be done according to Standard 780001, except as follows:

1. All words, such as ONLY, shall be 2.4 m (8 feet) high.
2. All non-freeway arrows shall be the large size.
3. The distance between yellow no-passing lines shall be 200 mm (8"), not 180 mm (7") as shown in the detail of Typical Lane and Edge Lines.

Aggregate Base Course, Type B, is provided in the plan quantities and shall be used only as needed when directed by the Engineer.

Work on this project will be in progress at the same time as work on the US 30 in Morrison. Work on these projects shall be scheduled to keep interference between all the projects to a minimum. The contractors shall inform each other of progress of the projects and give fair warning to the other contractors when a problem might be encountered.

The Contractor shall be responsible for protecting utility property during construction operations as outlined in Article 107.31 of the Standard Specifications. A minimum of 48 hours advance notice is required for non-emergency work. The JULIE number is 800-892-0123. The following listed utilities located within the project limits or immediately adjacent to the project construction limits are members of JULIE:

- Mediacom
- AT&T
- Frontier/Citizens
- US Sprint
- Commonwealth Edison Co.
- NICOR Gas Co.
- Lightcore

The layout and stationing for this project was extracted from the existing stationing stamped in the pavement at Station 187+50. Prior to stamping final stationing, the contractor shall contact Chad Pink, RE for the US 30 project in Morrison, at 815/772-0170 for coordination of stationing between these two projects on US 30.

TYPICAL SECTIONS

STA. 174+20 - STA. 340+00
 STA. 349+50 - STA. 369+56
 STA. 372+62 - STA. 380+88
 STA. 384+73 - STA. 414+20
 STA. 437+81 - STA. 505+15

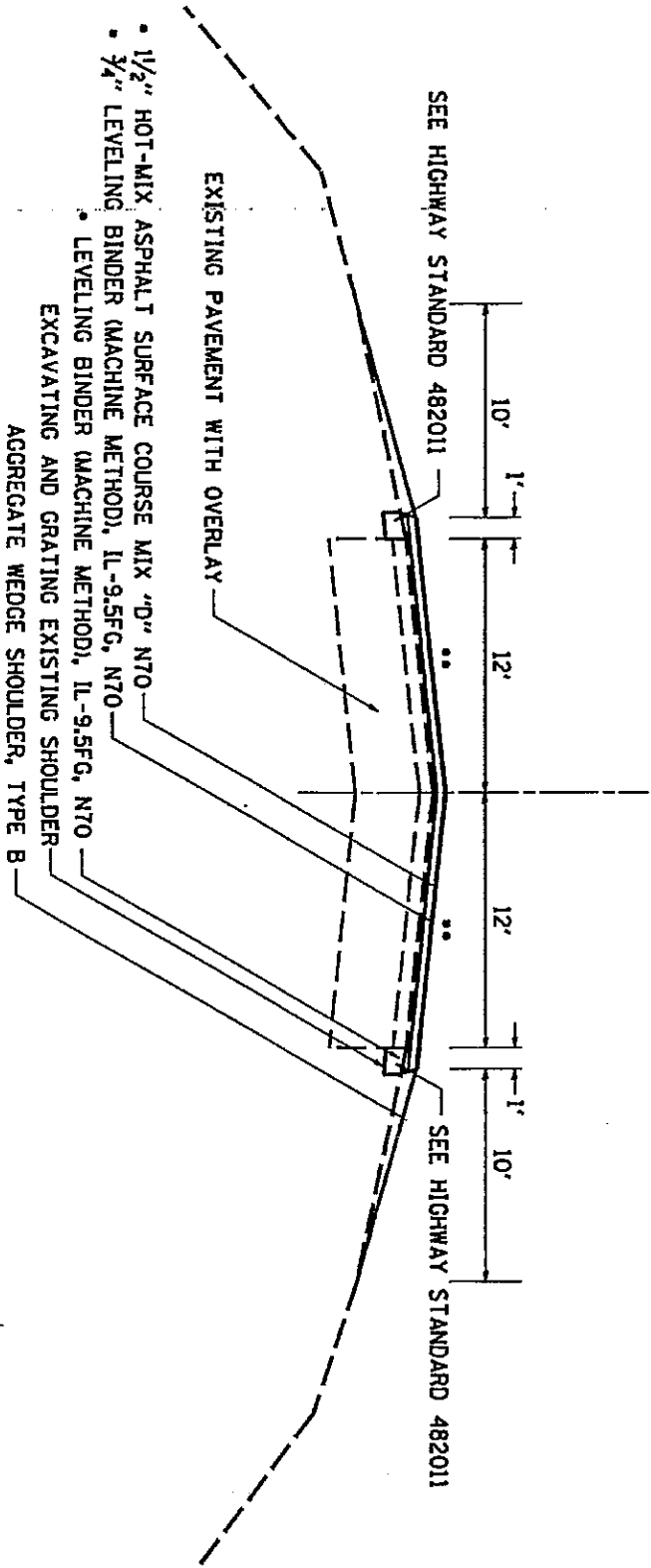

- HOT-MIX ASPHALT 112 LBS / SY / INCH
- MAINTAINING EXISTING CROSS SLOPE

SECTION 02, SPRING 85, 2007-2 CONTRACT NO. 64031

SECTION	COUNTY	TOTAL SHEET
009	WHITESIDE	8
STA.	TO STA.	
FED. ROAD DIST. NO.	ILLINOIS FED. AID PROJECT	

TYPICAL SECTIONS

STA. 340+00 - STA. 349+50

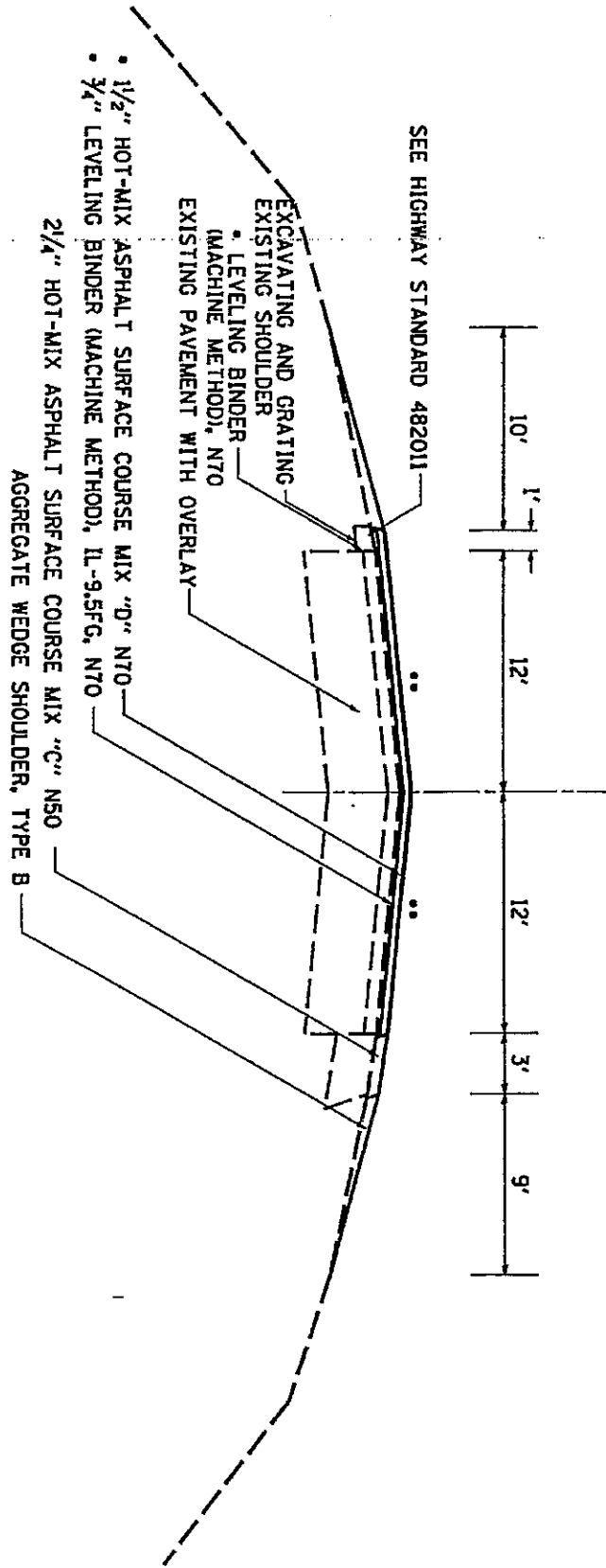

- HOT-MIX ASPHALT 112 LBS / SY / INCH
- MAINTAIN EXISTING CROSS SLOPE

...CADD\morrison typ.dgn 3/26/2007 2:50:09 PM

SECTION 02, SPRING, RS, 2007-2

CONTRACT NO. 64031

F.A.P. SECTION	COUNTY	TOTAL SHEET
309	WHITESIDE	38
STA.	TO STA.	9
FED. ROAD DIST. NO.	ILLINOIS FED. AID PROJECT	

SECTION 02.SPRING 85.2001-2 CONTRACT NO. 64031

F.A.P. SHEET NO.	SECTION	COUNTY	TOTAL SHEETS	SHEET NO.
309		WHITESIDE	38	10

TYPICAL SECTIONS

STA. 369+56 - STA. 372+62
 STA. 414+20 - STA. 415+05
 STA. 429+27 - STA. 430+46

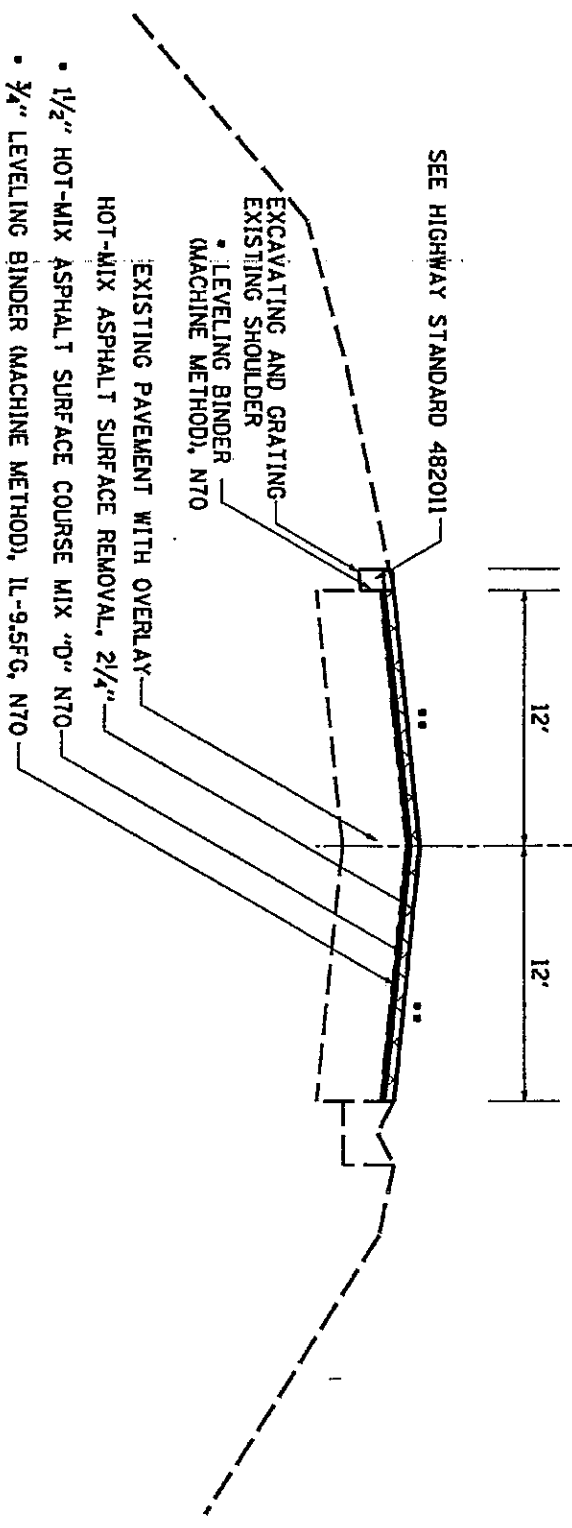

- HOT-MIX ASPHALT 112 LBS / SY / INCH
- MAINTAIN EXISTING CROSS SLOPE



= HOT-MIX ASPHALT SURFACE REMOVAL, 2 1/4"

SECTION 02 - SPRING, RS. 2007-2		CONTRACT NO. 64031	
F.A.R. NO.	SECTION	COUNTY	TOTAL SHEET NO.
3091		WHITESIDE	11
STA.	TO STA.	FED. ROAD DIST. NO.	ILLINOIS FED. AID PROJECT

TYPICAL SECTIONS

STA. 380+88 - STA. 384+73

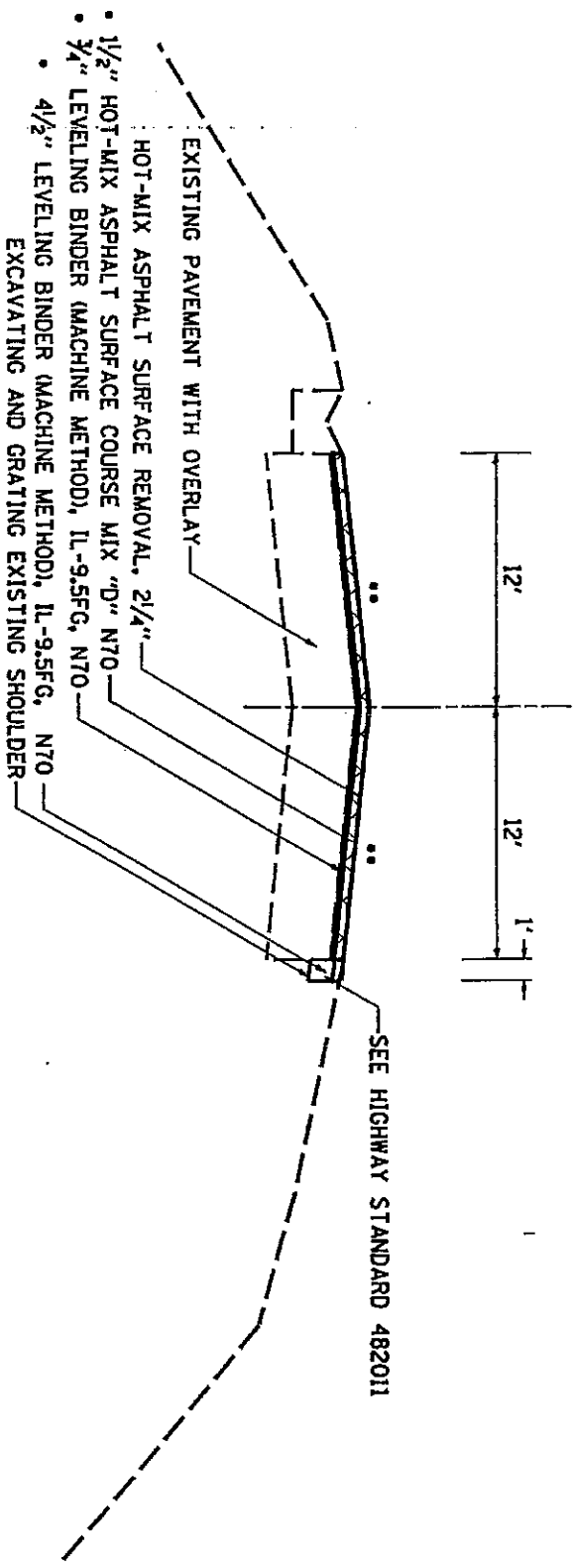

= HOT-MIX ASPHALT SURFACE REMOVAL, 2 1/4"

- HOT-MIX ASPHALT 112 LBS / SY / INCH
- • MAINTAIN EXISTING CROSS SLOPE

TYPICAL SECTIONS

STA. 415+05 - STA. 423+40
 STA. 430+46 - STA. 437+81

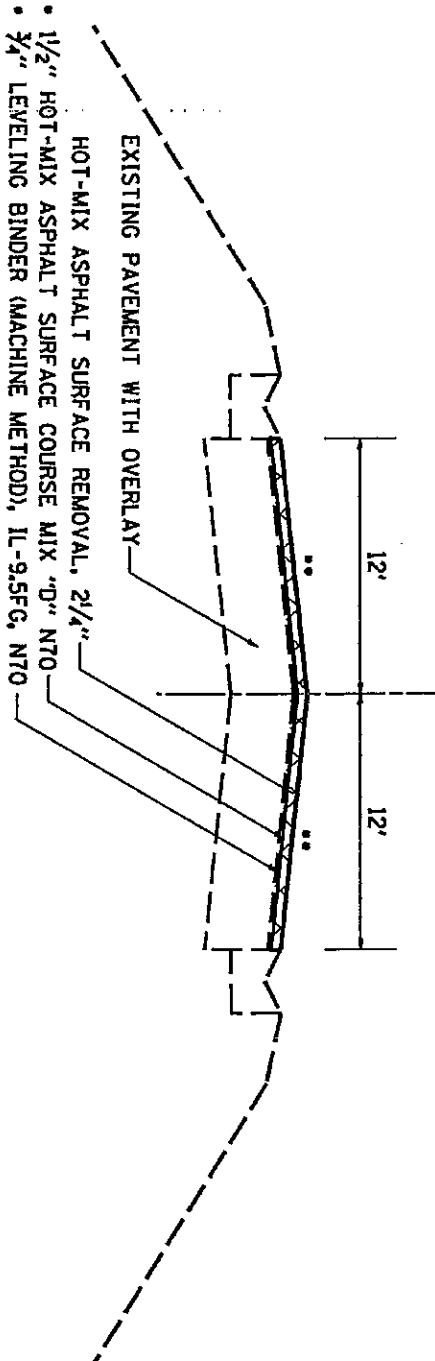

- HOT-MIX ASPHALT 112 LBS / SY / INCH
- MAINTAIN EXISTING CROSS SLOPE



= HOT-MIX ASPHALT SURFACE REMOVAL, 2 1/4"

SECTION 02 SPRING BS 2007-2

CONTRACT NO. 64031

F&P RTE.	SECTION	COUNTY	TOTAL SHEET SHEETS NO.
309		WHITESIDE	38
			12
STA.	TO STA.	FED. ROAD DIST. NO. ILLINOIS FED. AID PROJECT	

SECTION 02-SPRING BS 2001-2

CONTRACT NO. 64031

F.P.D. FILE	SECTION	COUNTY	TOTAL SHEETS	SHEET NO.
109		WHITESIDE	38	13
STA. TO STA.		ILLINOIS FED. AID PROJECT		

TYPICAL SECTIONS

STA. 423+40 - STA. 425+61
 STA. 421+31 - STA. 429+27

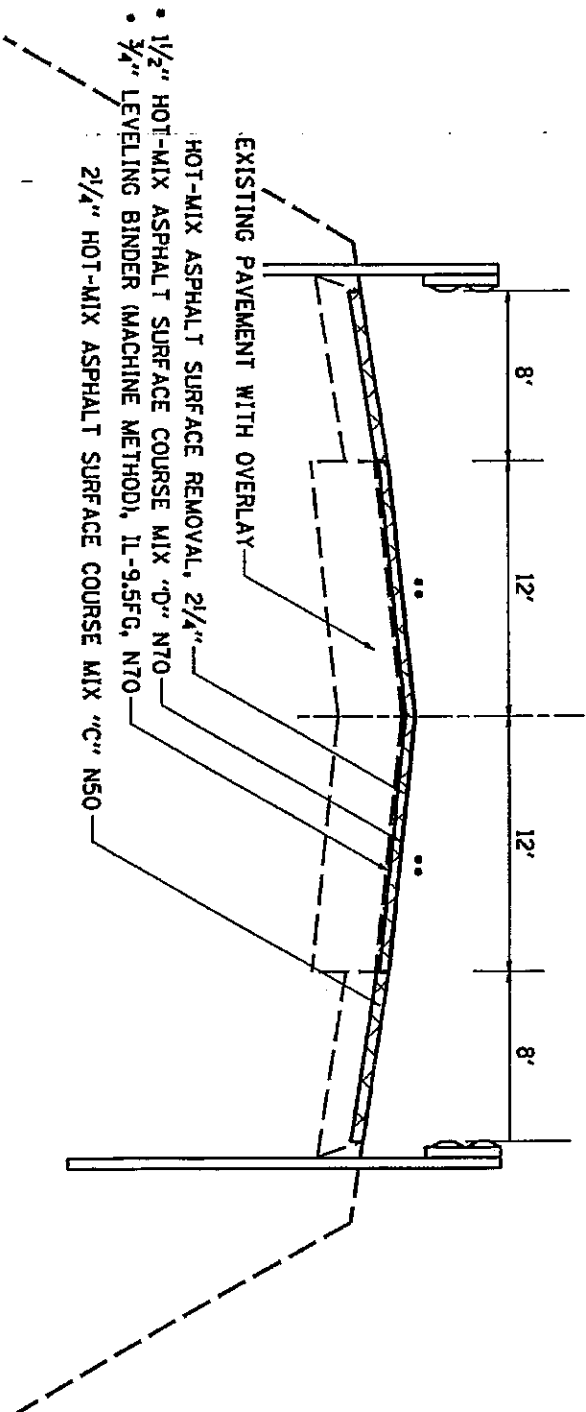

- HOT-MIX ASPHALT 112 LBS / SY / INCH
- MAINTAIN EXISTING CROSS SLOPE



= HOT-MIX ASPHALT SURFACE REMOVAL, 2 1/4"

SECTION 02 SPRING RS.2001-2		CONTRACT NO. 64D31	
FILE NO.	SECTION	COUNTY	TOTAL SHEET NO.
309		WHITESIDE	38
STA.	TO STA.	FED. ROAD DIST. NO. ILLINOIS FED. AID PROJECT	

TYPICAL SECTIONS

STA. 505+15 - STA. 507+30

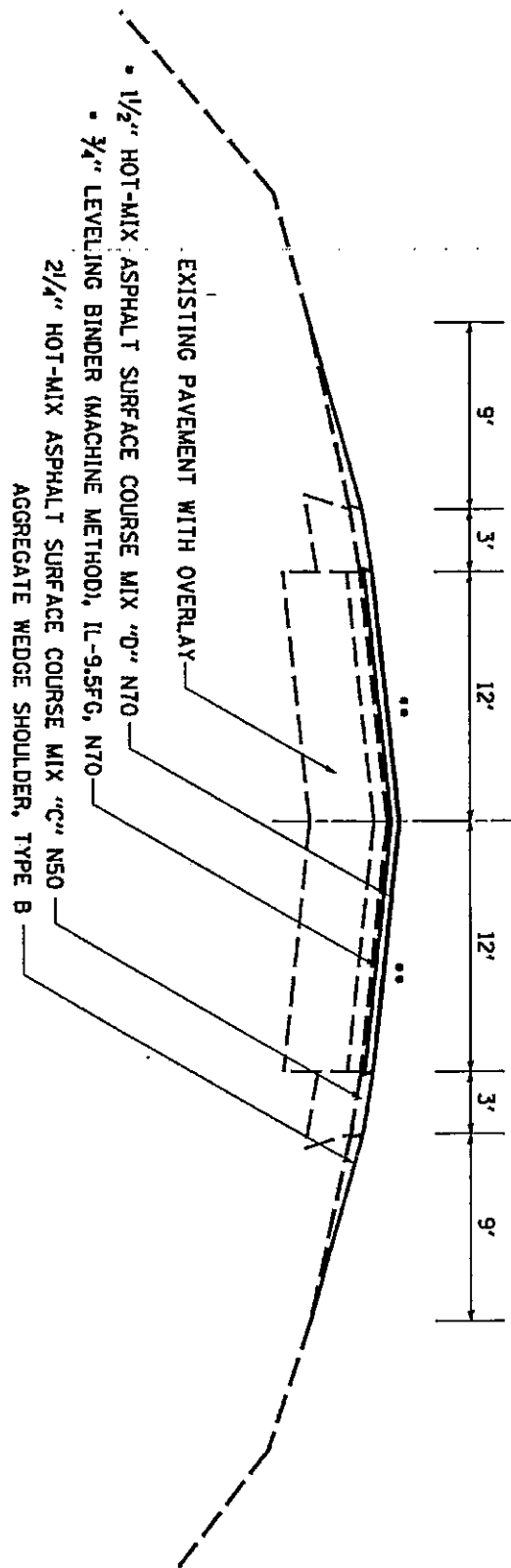

- HOT-MIX ASPHALT 112 LBS / SY / INCH
- MAINTAIN EXISTING CROSS SLOPE

TYPICAL SECTIONS

SECTION 02 SEBING BS 2001-2 CONTRACT NO. 64031

F&P RITE	SECTION	COUNTY	TOTAL SHEET SHEETS NO.
109		WILLIAMSIDE	38 - 15
STA.	TO STA.		
FED. ROAD DIST. NO. ILLINOIS FED. AID PROJECT			

STA. 208+08 - STA. 211+49
 STA. 212+40 - STA. 215+71
 STA. 304+51 - STA. 310+50
 STA. 411+65 - STA. 414+20

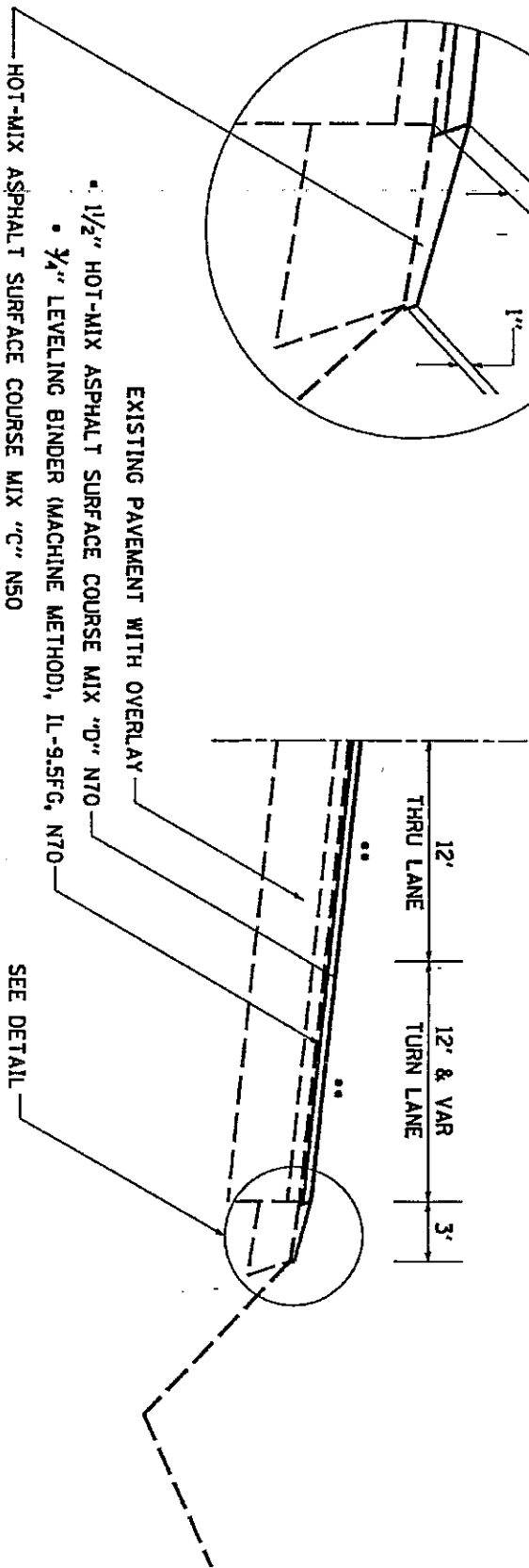
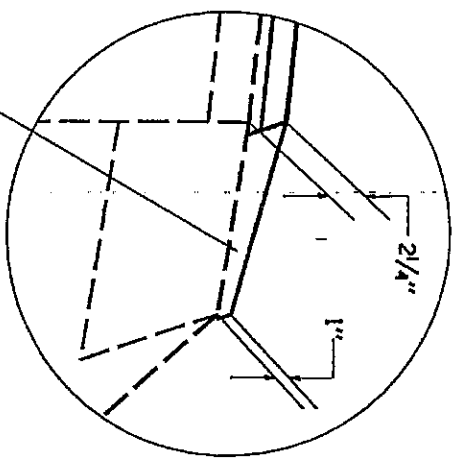

- HOT-MIX ASPHALT 112 LBS / SY / INCH
- MAINTAIN EXISTING CROSS SLOPE

TYPICAL SECTIONS

STA. 369+11 - STA. 369+56
 STA. 372+62 - STA. 373+07
 STA. 380+43 - STA. 380+88
 STA. 384+73 - STA. 385+18
 STA. 413+75 - STA. 414+20
 STA. 437+81 - STA. 438+26

45'

Notes:
 Variable depth grinding to be
 paid for as HOT-MIX ASPHALT
 SURFACE REMOVAL 2 1/4"

• HOT-MIX ASPHALT 112 LBS / SY / INCH

• 1 1/2" HOT-MIX ASPHALT SURFACE COURSE MIX "D" N70
 • 3/4" LEVELING BINDER (MACHINE METHOD), IL-9.5FG, N70

HOT-MIX ASPHALT SURFACE REMOVAL, 2 1/4"
 EXISTING PAVEMENT WITH OVERLAY

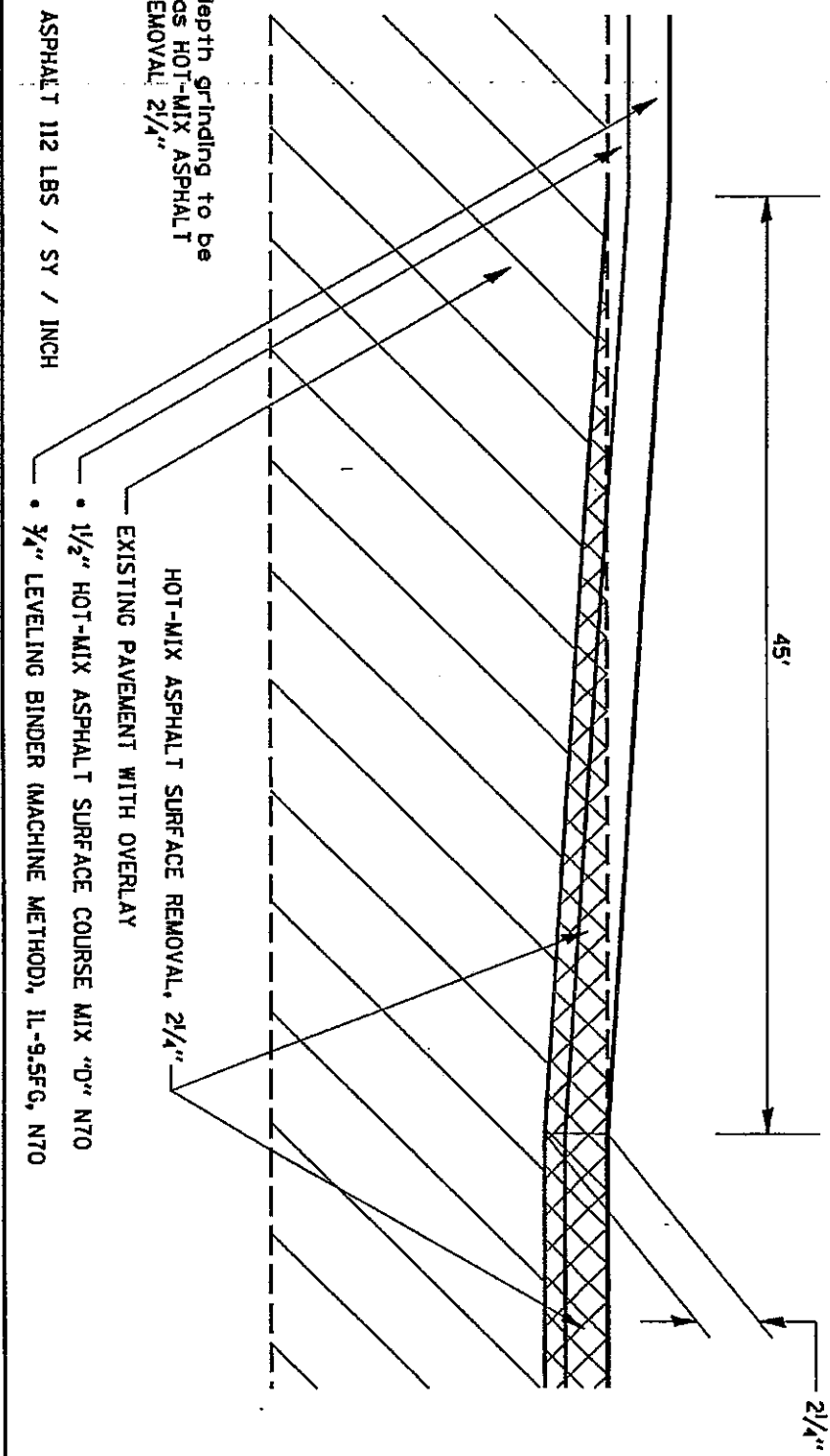

SECTION 02-SPRING-85-2001-2		CONTRACT NO. 64031	
DATE	SECTION	COUNTY	TOTAL SHEET
NO.			NO.
309		WHITESIDE	38
STA.	TO STA.	FED. ROAD DIST. NO. ILLINOIS FED. AID PROJECT	

SECTION 02-SEBING BS-2001-2 CONTRACT NO. 64031

TYPICAL SECTIONS

STA. 173+75 - STA. 174+20
 STA. 507+30 - STA. 507+75

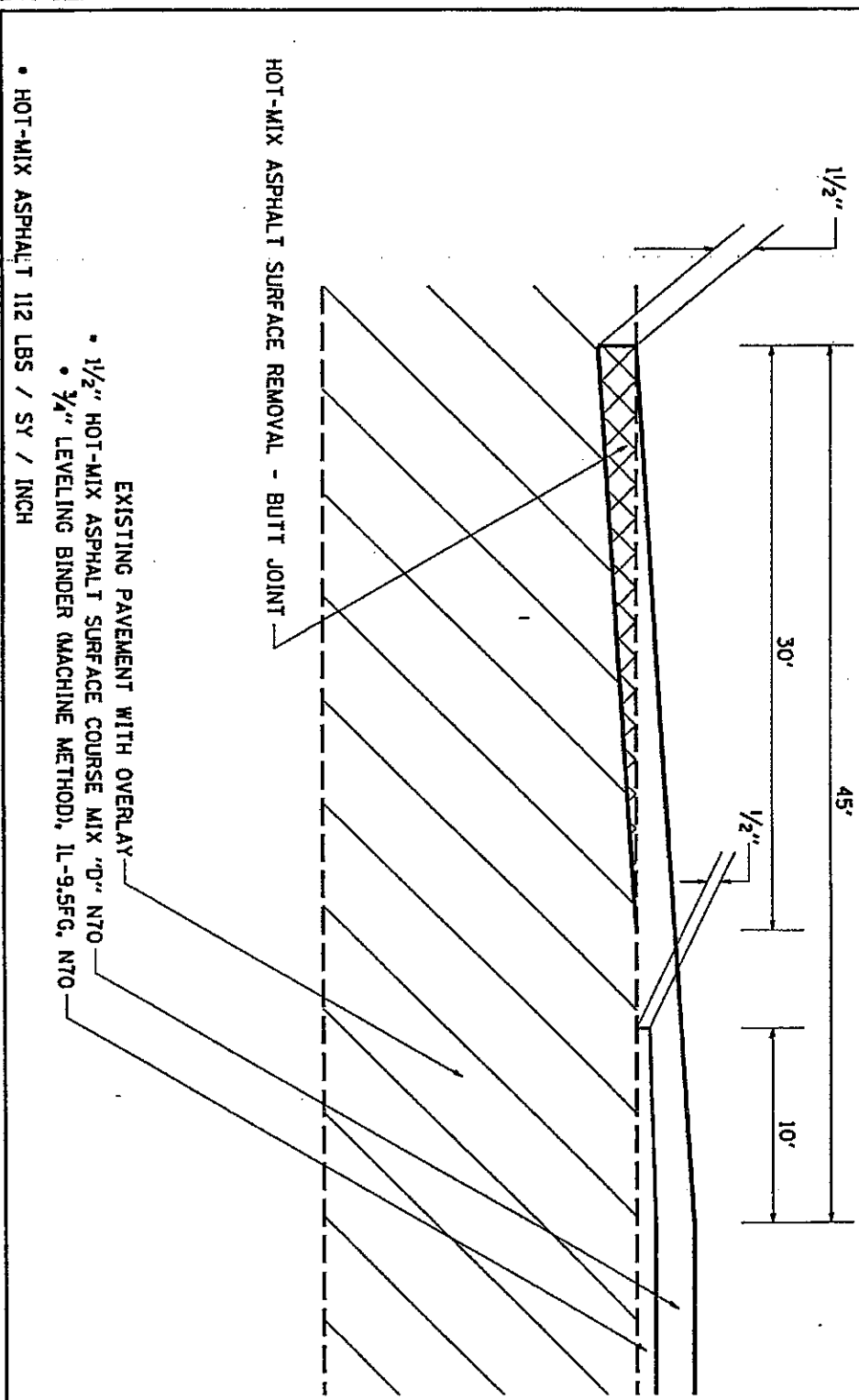

- HOT-MIX ASPHALT 112 LBS / SY / INCH
- 1/2" HOT-MIX ASPHALT SURFACE COURSE MIX "D" NTO
- 3/4" LEVELING BINDER (MACHINE METHOD), IL-9.5FG, NTO
- EXISTING PAVEMENT WITH OVERLAY
- HOT-MIX ASPHALT SURFACE REMOVAL - BUTT JOINT

F&E RITE	SECTION	COUNTY	TOTAL SHEETS	SHEET NO.
309		WHITESIDE	38	17
STA. TO STA.		ILLINOIS FED. AID PROJECT		

TYPICAL SECTIONS

SIDEROADS

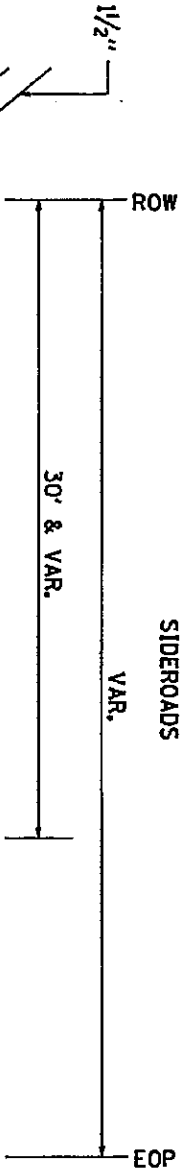

HOT-MIX ASPHALT SURFACE REMOVAL - BUTT JOINT

INCIDENTAL HOT-MIX ASPHALT SURFACE

EXISTING PAVEMENT

- 1/2" HOT-MIX ASPHALT SURFACE COURSE MIX "D" N70
- 3/4" LEVELING BINDER (MACHINE METHOD), IL-9.5FC, N70
- HOT-MIX ASPHALT: 112 LBS / SY / INCH

SECTION 02, SPRING, 85, 2007-2

CONTRACT NO. 64031

F.A.P. RTE.	SECTION	COUNTY	TOTAL SHEET NO.
309		WHITESIDE	38
STA. TO STA.			18
FED. ROAD DIST. NO.			ILLINOIS FED. AID PROJECT

BITUMINOUS SCHEDULE (MAINLINE)

FAP 301 (US 20)
 Section (26,27,28)RS
 Jo Daviess County
 Contract # 64C81
 Sheet 19 of 38

STATIONS	LENGTH FT	PROPOSED SURFACE						BIT. PRIME TON	AGG. PRIME TON	LEVELLING BINDER (MACH. METH.) IL-9.5FG N 70 TON	HOT-MIX ASPHALT SURF CSE MIX D N 70 TON	HOT-MIX ASPHALT SURF CSE MIX C N 50 TON	EXCAVATING AND GRADING EXISTING SHOULDERS UNIT	HOT-MIX ASPHALT REMOVAL 2.25 INCH SQ. YD.
		PAVEMENT		SHOULDER		LT	RT							
		WIDTH	SQ. YD.	LT	RT									
173 + 75 - 208 + 8	3433	26	9917.6					5.67	14.88	704.9	833.1		68.7	
208 + 8 - 210 + 5	197	TL	678.6				3.0	0.41	1.02	42.3	57.0	7.4	2.0	
210 5 - 211 + 49	144	36	576.0				3.0	0.34	0.86	35.4	48.4	5.4	1.4	
211 + 49 - 212 + 40	91	26	262.9					0.15	0.39	18.7	22.1		1.8	
212 + 40 - 213 + 71	131	36	524.0					0.31	0.79	32.2	44.0	4.9	1.3	
213 + 71 - 215 + 71	200	TL	688.9					0.41	1.03	42.9	57.9	7.5	2.0	
215 + 71 - 304 + 51	8880	26	25653.3					14.67	38.48	1823.4	2154.9		177.6	
304 + 51 - 307 + 87	336	36	1344.0				3.0	0.80	2.02	82.6	112.9	12.5	3.4	
307 + 87 - 310 + 50	283	TL	905.9				3.0	0.54	1.36	56.5	76.1	9.8	2.6	
310 + 50 - 340 + 0	2950	26	8522.2					4.87	12.78	606.7	715.9	35.5	60.0	
340 + 0 - 349 + 50	950	26	2744.4					1.86	4.12	174.4	230.5		9.5	
349 + 50 - 369 + 56	2006	26	5795.1					3.31	8.69	411.9	486.8		40.1	
369 + 56 - 372 + 62	306	25	850.0					0.49	1.28	54.3	71.4		3.1	1066.0
372 + 62 - 380 + 88	826	26	2386.2					1.36	3.58	169.6	200.4		16.5	
380 + 88 - 384 + 73	385	25	1069.4					0.61	1.60	68.3	89.8		3.9	1276.7
384 + 73 - 411 + 65	2692	26	7776.9					4.45	11.67	562.8	653.3		53.8	
411 + 65 - 412 + 90	125	36	500.0				3.0	0.30	0.75	30.7	42.0	5.3	2.5	
412 + 90 - 414 + 20	130	TL	491.1					0.29	0.74	30.3	41.3	5.5	1.3	
414 + 20 - 415 + 5	85	TL	273.9				3.0	0.16	0.41	17.2	23.0	3.6	0.9	255.0
415 + 5 - 423 + 40	835	25	2319.4					1.33	3.48	148.1	194.8			2226.7
423 + 40 - 425 + 61	221	25	613.9				8.0	0.46	0.92	34.4	51.6	44.0		982.2
425 + 61 - 427 + 31	170	26	491.1				OMISSION							
427 + 31 - 429 + 27	196	25	544.4				8	0.41	0.82	30.5	45.7	39.0		871.1
429 + 27 - 430 + 46	115	25	319.4				8	0.21	0.48	20.4	26.8	11.4	1.2	408.9
430 + 46 - 437 + 81	735	25	2041.7					1.17	3.06	130.3	171.5			2085.0
437 + 81 - 505 + 15	6734	26	19453.8					11.13	29.18	1382.7	1634.1			
505 + 15 - 507 + 75	260	26	866.7				3	0.55	1.30	48.5	72.8	17.0		
TOTALS								56.1	145.7	6748.9	8153.1	208.7	587.2	9171.6

PARTIAL DEPTH PATCHING SCHEDULE

FAP ROUTE 309 (US 30)
 D2 SPRING RS 2007-2
 Whiteside County
 Contract #64D31
 Sheet 22 of 38

STATION	WIDTH OF LANE FT	LENGTH OF PATCH			SQ. YD.	CLASS B PATCHES TYPE 2, 10 INCH	SQ. YD.	CLASS B PATCHES TYPE 3, 10 INCH	SQ. YD.	CLASS B PATCHES TYPE 4, 10 INCH	SQ. YD.	HOT-MIX ASPH. REM. OVER PATCHES 2 1/2 IN	SQ. YD.	40601005 HOT-MIX ASPH. REPLACE OVER PATCHES	TONS	TONS
		LT LANE	RT LANE	LANE												
175 + 90	12		6		8.0	8.0						9.33	9.33	1.31	1.31	
181 + 88	12		32	32					42.7	42.7		44.00	44.00	6.16	6.16	
186 + 50	12			6		8.0							9.33	1.31	1.31	
193 + 16	12			6		8.0							9.33	1.31	1.31	
193 + 76	12		6		8.0							9.33		1.31	1.31	
193 + 95	12			6		8.0							9.33	1.31	1.31	
203 + 50	12			6		8.0							9.33	1.31	1.31	
204 + 58	12		6	6	8.0	8.0						9.33	9.33	1.31	1.31	
205 + 51	12		8	8	10.7	10.7						12.00	12.00	1.68	1.68	
211 + 97	12		10		13.3							14.67		2.05	2.05	
217 + 92	12		8	8	10.7	10.7						12.00	12.00	1.68	1.68	
219 + 11	12		8	8	10.7	10.7						12.00	12.00	1.68	1.68	
231 + 89	12		8	8	10.7	10.7						12.00	12.00	1.68	1.68	
234 + 68	12		8	8	10.7	10.7						12.00	12.00	1.68	1.68	
253 + 61	12		8	8	10.7	10.7						12.00	12.00	1.68	1.68	
260 + 39	12			8		10.7						12.00	12.00	1.68	1.68	
260 + 44	12		24	24					32.0	32.0		33.33	33.33	4.67	4.67	
274 + 3	12		8	8	10.7	10.7						12.00	12.00	1.68	1.68	
282 + 52	12		10	10	13.3	13.3						14.67	14.67	2.05	2.05	
292 + 4	12		6		8.0							9.33		1.31	1.31	
308 + 75	12		8	8	10.7	10.7						12.00	12.00	1.68	1.68	
322 + 59	12		8	8	10.7	10.7						12.00	12.00	1.68	1.68	
326 + 12	12		8	8	10.7	10.7						12.00	12.00	1.68	1.68	
326 + 57	12		6	6	8.0	8.0						9.33	9.33	1.31	1.31	
329 + 56	12		16	6	8.0	8.0						22.67	9.33	3.17	1.31	
337 + 47	12		26						34.7			36.00		5.04	5.04	
337 + 85	12		6		8.0							9.33		1.31	1.31	
349 + 47	12		15	8	10.7	10.7						21.33	12.00	2.99	1.68	
354 + 38	12		1	8	10.7	10.7						12.00	12.00	1.68	1.68	
PAGE SUB TOTAL					181.3	205.3	41.3	0.0	109.3	74.7	362.7	310.7	50.8	43.5		

PARTIAL DEPTH PATCHING SCHEDULE

FAP ROUTE 309 (US 30)
 D2 SPRING RS 2007-2
 Whiteside County
 Contract #64D31
 Sheet 23 of 38

STATION	WIDTH OF LANE FT	LENGTH OF PATCH			CLASS B PATCHES TYPE 2, 10 INCH	CLASS B PATCHES TYPE 3, 10 INCH	CLASS B PATCHES TYPE 4, 10 INCH	HOT-MIX ASPH. REM. OVER PATCHES 2 1/2 IN	HOT-MIX HOT-MIX ASPH. REPLACE OVER PATCHES	TONS	TONS		
		LT LANE	RT LANE	FT								SQ. YD.	SQ. YD.
357 + 20	12		6		8.0				9.33	1.31			
361 + 45	12			20				26.7	12.00	1.68	3.92		
371 + 88	12		8		10.7				9.33	1.31			
380 + 57	12		6		8.0				9.33	1.31			
381 + 50	12		6		8.0				9.33	1.31			
393 + 83	12		6		8.0				9.33	1.31			
394 + 96	12		6		8.0				9.33	1.31			
395 + 18	12		6		8.0				9.33	1.31			
407 + 9	12		6		8.0				9.33	1.31			
407 + 61	12		8	24	10.7			32.0	12.00	1.68	4.67		
442 + 68	12		6		8.0				9.33	1.31			
443 + 47	12		6		8.0				9.33	1.31			
449 + 95	12		6		8.0				9.33	1.31			
453 + 47	12		6		8.0				9.33	1.31			
466 + 35	12		6		8.0				9.33	1.31			
467 + 13	12		6		8.0				9.33	1.31			
485 + 1	12		6		8.0				9.33	1.31			
485 + 35	12		10		13.3				14.67	2.05	2.05		
492 + 74	12		8		10.7				12.00	1.68	1.68		
494 + 65	12		8		10.7				12.00	1.68	1.68		
505 + 49	12		6		8.0				9.33	1.31			
506 + 30	12		8		10.7				12.00	1.68	1.68		
506 + 80	12		6		8.0				9.33	1.31			
506 + 94	12		6		8.0				9.33	1.31			
PAGE SUB TOTAL					202.7	165.3	0.0	0.0	58.7	233.3	262.0	32.7	35.3
PAY ITEM TOTAL					754.7	165.3	0.0	0.0	242.7	1158.7	162.2		
FULL DEPTH TOTAL SQ YDS (#of Patches)					75.6 (10)		20.0 (1)		32.0 (1)				

SCHEDULE OF QUANTITIES

FAP Route 309 (US30)
 D2 SPRING RS 2007-2
 Whiteside County
 Contract #64D31
 Sheet 24 of 38

40600982 HOT-MIX ASPHALT SURFACE REMOVAL- BUTT JOINT

LOCATION	SQ YD	REMARKS
STA. 173+75 - 174+20 LT & RT	80	BEGIN PROJECT
STA. 507+30 - 507+75 LT & RT	80	END PROJECT
FELDMAN ROAD RT	70	
LYNDON ROAD RT	127	
LYNDON ROAD LT	137	
YAGER ROAD RT	70	
YAGER ROAD LT	73	
ROUND GROVE ROAD RT	83	
ROUND GROVE ROAD LT	70	
YORKTOWN ROAD LT	67	
WHITE OAKS ROAD LT	83	
BLUE GOOSE ROAD LT	67	
MATZNIK ROAD RT	70	
HABREN ROAD LT	73	
TOTAL	1150	

40600990 TEMPORARY RAMP

LOCATION	SQ YD	REMARKS
STA. 173+75 LT & RT	13.3	BEGIN CONST.
STA. 425+61 LT & RT	21.3	BRIDGE OMISSION
STA. 427+31 LT & RT	21.3	BRIDGE OMISSION
STA. 507+75 LT & RT	13.3	END CONST.
FELDMAN ROAD RT	13.8	
LYNDON ROAD RT	13.8	
LYNDON ROAD LT	13.8	
YAGER ROAD RT	13.8	
YAGER ROAD LT	13.8	
ROUND GROVE ROAD RT	13.8	
ROUND GROVE ROAD LT	13.8	
YORKTOWN ROAD LT	13.8	
WHITE OAKS ROAD LT	13.8	
BLUE GOOSE ROAD LT	13.8	
MATZNIK ROAD RT	13.8	
HABREN ROAD LT	13.8	
TOTAL	235	

SCHEDULE OF QUANTITIES

42001200 PAVEMENT FABRIC

	LOCATION		TOTAL	
	STA. 173+75 - 507+75 LT & RT (Patches)		52	
REMARKS		SQ YDS	52	Contingency for Full Depth Patches

44213200 SAW CUTS

	LOCATION		TOTAL	
	STA. 173+75 - 507+75 LT & RT (Patches)		630	
REMARKS		FOOT	630	Contingency for Full Depth Patches.

48102100 AGGREGATE WEDGE SHOULDERS, TYPE B

	LOCATION		TOTAL	
	STA. 173+75 - 507+75 LT & RT		8629	
REMARKS		Ton	8629	See Typical for width

70300100 SHORT TERM PAVEMENT MARKING

	LOCATION		TOTAL	
	STA. 173+75 - 340+00		4992	
	STA. 340+00 - 349+50		288	
	STA. 349+50 - 369+11		588	
	STA. 369+11 - 373+07		160	
	STA. 373+07 - 380+43		216	
	STA. 380+43 - 385+18		192	
	STA. 385+18 - 413+75		852	
	STA. 413+75 - 425+61		480	
	STA. 427+31 - 438+26		432	
	STA. 438+26 - 504+70		1992	
	STA. 504+70 - 507+75		96	
REMARKS		FOOT	10288	

SCHEDULE OF QUANTITIES

FAP Route 309 (US30)
 D2 SPRING RS 2007-2
 Whiteside County
 Contract #64D31
 Sheet 26 of 38

70301000 WORK ZONE PAVEMENT MARKING REMOVAL

<u>LOCATION</u>	<u>REMARK</u>	<u>SO FT</u>
STA. 173+75 - 507+75		1113
	TOTAL	1113

78000100 THERMOPLASTIC PAVEMENT MARKING - LETTERS & SYMBOLS

<u>LOCATION</u>	<u>REMARK</u>	<u>SO FT</u>
STA. 210+06 RT	RT turn arrow	15.6
STA. 210+97 RT	RT turn arrow	15.6
STA. 212+82 LT	RT turn arrow	15.6
STA. 213+61 LT	RT turn arrow	15.6
STA. 305+46 LT	RT turn arrow	15.6
STA. 306+77 LT	RT turn arrow	15.6
STA. 307+56 LT	RT turn arrow	15.6
STA. 412+06 LT	RT turn arrow	15.6
STA. 412+85 LT	RT turn arrow	15.6
	TOTAL	140.4

FAP Route 309 (US30)
 D2 SPRING RS 2007-2
 Whiteside County
 Contract #64D31
 Sheet 27 of 38

SCHEDULE OF QUANTITIES

78000500 THERMOPLASTIC PAVEMENT MARKING - LINE 8 INCH

LOCATION	FOOT	REMARKS
STA. 210+06 - 211+09 RT	100	Turn Lane
STA. 212+67 - 213+71 LT	100	Turn Lane
STA. 304+88 - 307+92 LT	330	Turn Lane
STA. 411+83 - 412+97 LT	110	Turn Lane
STA. 304+88 LT	105	Painted Island
TOTAL	745	

78000600 THERMOPLASTIC PAVEMENT MARKING - LINE 12 INCH

LOCATION	FOOT	REMARKS
STA. 304+88 LT	104	Painted Island
TOTAL	104	

78000620 THERMOPLASTIC PAVEMENT MARKING - LINE 18 INCH

LOCATION	REMARK	FOOT
STA. 280+05	Aerial speed check zone	12
STA. 286+65	Aerial speed check zone	12
STA. 293+25	Aerial speed check zone	12
TOTAL		36

78000650 THERMOPLASTIC PAVEMENT MARKING - LINE 24 INCH

LOCATION	FOOT	REMARKS
LYNDON ROAD RT	23	Stop Bar 27' from EOP
LYNDON ROAD LT	27	Stop Bar 28' from EOP
TOTAL	50	

SCHEDULE OF QUANTITIES

FAP Route 309 (US30)
 D2 SPRING RS 2007-2
 Whiteside County
 Contract #64D31
 Sheet 28 of 38

78001110 PAINT PAVEMENT MARKING- LINE 4 INCH

REMARKS	FOOT	LOCATION (2 APPLICATIONS) (YELLOW)	TOTAL (YELLOW)	TOTAL (WHITE)	TOTAL
Skip Dashes	8440	STA. 173+75 - 342+35			
WB Skip Dashes, EB No Pass	1700	STA. 342+35 - 349+15			
Dbl. Yellow	1140	STA. 349+15 - 352+00			
EB Skip Dashes, WB No Pass	2118	STA. 352+00 - 360+49			
Skip Dashes	780	STA. 360+49 - 376+15			
WB Skip Dashes, EB No Pass	1730	STA. 376+15 - 383+10			
Skip Dashes	180	STA. 383+10 - 386+52			
EB Skip Dashes, WB No Pass	1522	STA. 386+52 - 392+63			
Skip Dashes	640	STA. 392+63 - 405+54			
WB Skip Dashes, EB No Pass	1296	STA. 405+52 - 410+72			
Dbl. Yellow	1584	STA. 410+72 - 414+68			
EB Skip Dashes, WB No Pass	2380	STA. 414+68 - 424+18			
Skip Dashes	240	STA. 424+18 - 429+00			
WB Skip Dashes, EB No Pass	1828	STA. 429+00 - 436+34			
Skip Dashes	40	STA. 436+34 - 436+89			
EB Skip Dashes, WB No Pass	2316	STA. 436+89 - 446+17			
Dbl. Yellow	2628	STA. 446+17 - 452+74			
EB Skip Dashes, WB No Pass	2110	STA. 452+74 - 461+19			
Skip Dashes	2060	STA. 461+19 - 502+17			
WB Skip Dashes, EB No Pass	1326	STA. 502+17 - 507+50			
Dbl. Yellow	100	STA. 507+50 - 507+75			
TOTAL	<u>36158</u>	TOTAL (YELLOW)			
Edge lines	100744	STA. 173+75 - 425+61			
Edge lines	32176	STA. 427+31 - 507+75			
TOTAL	<u>132920</u>	TOTAL (WHITE)			
	169078				

78100100 RAISED REFLECTIVE PAVEMENT MARKERS

REMARKS	EACH	LOCATION	TOTAL
WHITE			
Turn Lane-40' O.C. Crystal 1 way	3	STA. 210+06 - 211+09 RT	
Turn Lane-40' O.C. Crystal 1 way	3	STA. 212+67 - 213+71 LT	
Turn Lane-40' O.C. Crystal 1 way	8	STA. 304+88 - 307+92 LT	
Turn Lane-40' O.C. Crystal 1 way	4	STA. 411+83 - 412+97 LT	
YELLOW			
Centerline-80' O.C.- Amber 2 way	419	STA. 173+75 - 507+75	
TOTAL	<u>437</u>		

SCHEDULE OF QUANTITIES

78300200 RAISED REFLECTIVE PAVEMENT MARKER REMOVAL

LOCATION	EACH	REMARKS
STA. 210+06 - 211+09 RT	3	Turn Lane
STA. 212+67 - 213+71 LT	3	Turn Lane
STA. 304+88 - 307+92 LT	7	Turn Lane
STA. 411+83 - 412+97 LT	4	Turn Lane
STA. 173+75 - 507+75	395	Centerline
TOTAL	412	

LOCATION	EACH	REMARKS
STA. 173+75 - 507+75 LT & RT (Patches)	240	Contingency for Full Depth Patches
TOTAL	240	

LOCATION	SO YD	REMARKS
STA. 173+75 - 507+75 LT & RT (Patches)	1188	Contingency for Full Depth Patches
TOTAL	1188	

LOCATION	CU YD	REMARKS
STA. 173+75 - 507+75 LT & RT (Patches)	198	Contingency for Full Depth Patches
TOTAL	198	

LOCATION	EACH	REMARKS
STA. 173+75 - 507+75 LT & RT (Patches)	13	Contingency for Full Depth Patches
TOTAL	13	

HOT-MIX ASPHALT SHOULDER

SECTION 02 SPRING RS 2007-2 CONTRACT NO. 64031

F&P RTE.	SECTION	COUNTY	TOTAL SHEET SHEETS NO.
309	*	WHITESIDE	38 30
STA.	TO STA.		
FED. ROAD DIST. NO.	ILLINOIS FED. AID PROJECT		

GENERAL NOTES

THE HOT-MIX ASPHALT SHOULDER SHALL BE CONSTRUCTED IN ACCORDANCE WITH SECTION 482 EXCEPT THE TOP LIFT SHALL BE HOT-MIX ASPHALT SURFACE COURSE, MIX "C", N50 *40603310. THE WORK WILL BE PAID FOR AT THE CONTRACT UNIT PRICE PER TON FOR HOT-MIX ASPHALT SURFACE COURSE, MIX "C", N50 *40603310 AND SQUARE YARD FOR HOT-MIX ASPHALT SHOULDERS OF THE THICKNESS SPECIFIED.

USE HOT-MIX ASPHALT SURFACE COURSE, MIX "C", N50 *40603310. WHEN RESURFACING EXISTING HOT-MIX ASPHALT SHOULDERS: THE THICKNESS IS SHOWN ON THE TYPICAL SECTIONS. THIS WORK WILL BE PAID FOR AT THE CONTRACT UNIT PRICE PER TON FOR HOT-MIX ASPHALT SURFACE COURSE, MIX "C", N50 *40603310.

REMOVAL OF MATERIAL FOR PLACEMENT OF THE HOT-MIX ASPHALT SHOULDER TO BE PAID FOR IN UNITS FOR EXCAVATING AND GRADING EXISTING SHOULDERS OR IN CUBIC YARDS FOR EARTH EXCAVATION OR EARTH EXCAVATION WIDENING.

* 4% WHEN MAINLINE IS ON TANGENT, FOR CROSS SLOPE ON SUPERELEVATION SECTION, SEE HIGHWAY STANDARD 482001 OR 482006.

+ = SEE TYPICAL SECTIONS FOR THICKNESS

ALL DIMENSIONS ARE IN MILLIMETERS (INCHES) UNLESS OTHERWISE NOTED.

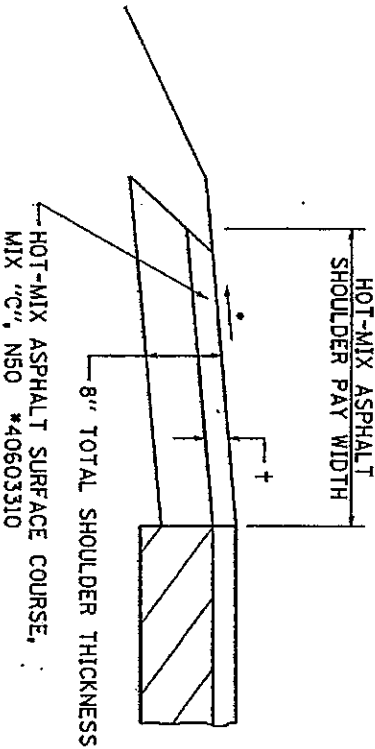

HOT-MIX ASPHALT SHOULDER 23.4a

REVISED 10-06-06

10-06-06
10-06-06
10-06-06
10-06-06

PAVEMENT PATCHING FOR HOT-MIX ASPHALT SURFACED PAVEMENT

SECTION D2 SPRING RS 2001-2 CONTRACT NO. 64031

F.A.P. RITE	SECTION	COUNTY	TOTAL SHEET NO.
309	*	WHITESIDE	38
STA.	TO STA.	FED. ROAD DIST. NO.	ILLINOIS FED. AID PROJECT

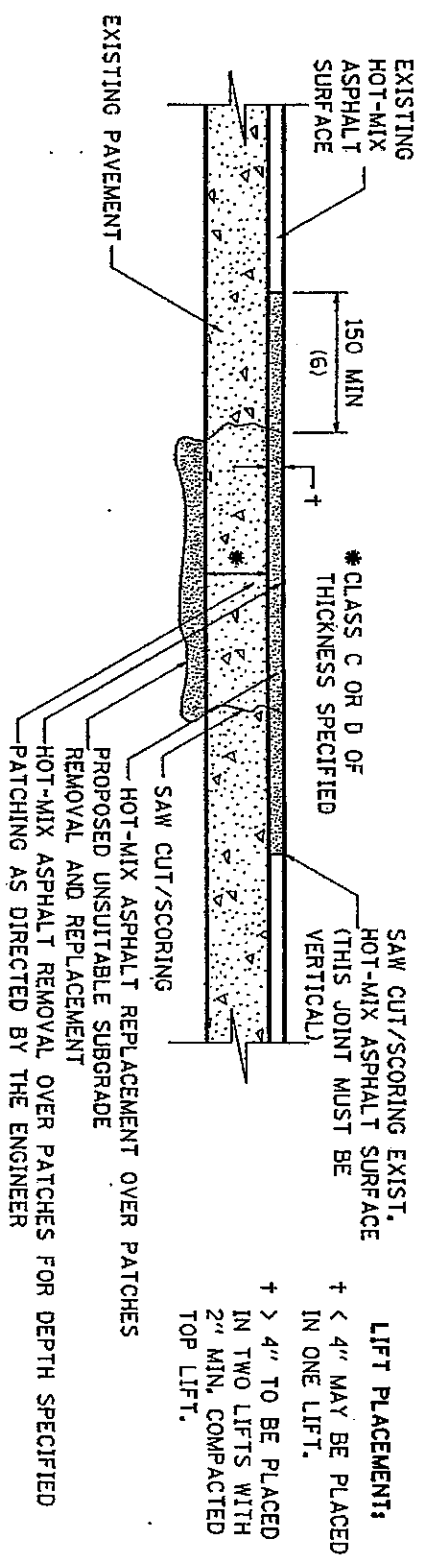

SEQUENCE OF CONSTRUCTION:

1. REMOVE THE EXISTING HOT-MIX ASPHALT SURFACE.
2. RESIDENT ENGINEER WILL DETERMINE IF LOCATION IS TO BE PATCHED OR TO ONLY REPLACE HOT-MIX ASPHALT SURFACE.
3. REMOVE AND REPLACE FULL DEPTH PATCHES AT LOCATIONS DIRECTED BY THE ENGINEER.
4. REPLACE HOT-MIX ASPHALT SURFACE OVER FULL DEPTH PATCHES AND AT LOCATIONS OF HOT-MIX ASPHALT SURFACE REMOVAL.

GENERAL NOTES:

1. THE WIDTH OF THE FULL DEPTH PATCH OVER A TRENCH SHALL BE 300 (12) WIDER ON EACH SIDE OF THE TRENCH.
 2. FOR BASIS OF PAYMENT, SEE SPECIAL PROVISION "PATCHING WITH HOT-MIX ASPHALT OVERLAY REMOVAL".
- ALL DIMENSIONS ARE IN MILLIMETERS (INCHES) UNLESS OTHERWISE NOTED.

PAVEMENT PATCHING, FOR HOT-MIX ASPHALT SURFACED PAVEMENT 32.4

REVISED 10-10-06

AERIAL SPEED CHECK ZONES

SECTION 02 SPRING RS 2007-2 CONTRACT NO. 64031

F.A.P. FILE NO.	SECTION	COUNTY	WHITE SIDE	TOTAL SHEET NO.
309				38
				32

STA.	TO STA.	FED. ROAD DIST. NO.	ILLINOIS FED. AID PROJECT

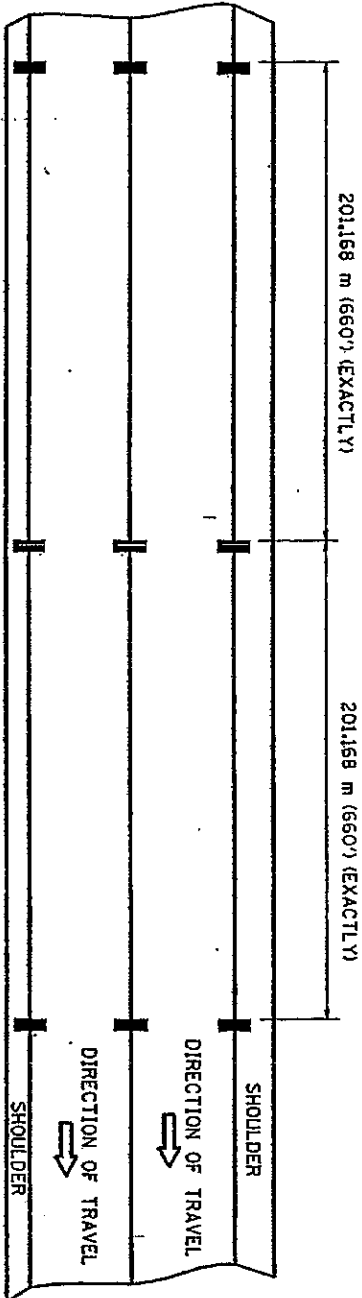

ALWAYS USE PERFORMED THERMOPLASTIC PAVEMENT MARKINGS

PAVEMENT MARKING DETAIL

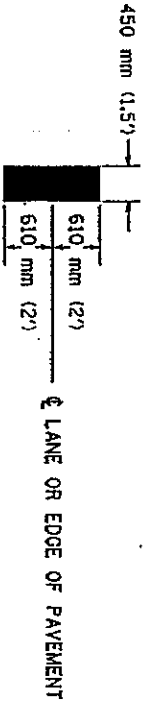

POLICE AERIAL SPEED CHECK ZONES

ESTABLISHED ZONES AND NEW ZONES REQUESTED BY THE ILLINOIS STATE POLICE SHALL BE MARKED CONSISTENT WITH THE REQUIREMENTS OF SECTION 58-23 OF THE MUTCD. WHEN NEW ZONES ARE PLACED IT WILL BE NECESSARY TO HAVE A REPRESENTATIVE OF THE STATE POLICE PRESENT SO THAT THE ACCURACY OF THE MEASUREMENT CAN BE ATTESTED TO IN COURT.

AERIAL SPEED CHECK ZONES

46.4

REVISED 2-1-05

SUBGRADE REPLACEMENT

SECTION 02 SPRING RS 2007-2		CONTRACT NO. 64031	
F&P R.E.	SECTION	COUNTY	TOTAL SHEET SHEETS NO.
309	.	WHITESIDE	38 33
STA.	TO STA.		
FED. AID DIST. NO. ILLINOIS FED. AID PROJECT			

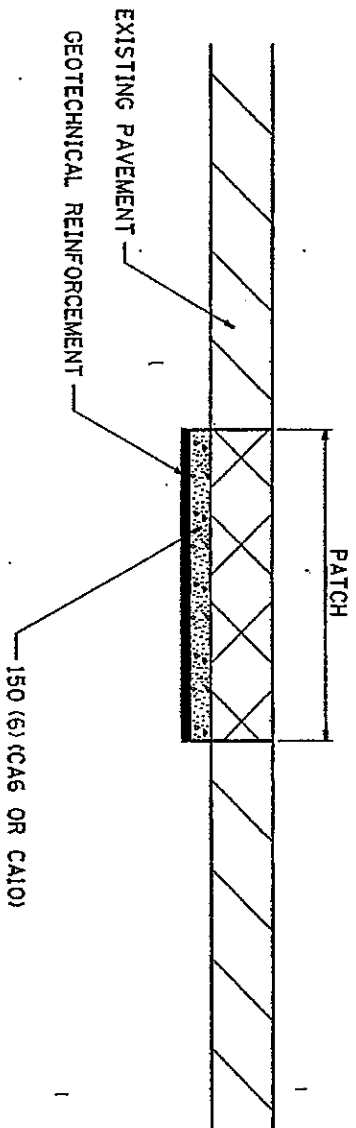

NOTES:

THA CA 6 OR CA 10 AND REMOVAL OF UNSUITABLE MATERIAL SHALL BE PAID FOR AT THE CONTRACT UNIT PRICE PER CU YD FOR GRANULAR SUBGRADE REPLACEMENT.

ALL DIMENSIONS ARE IN MILLIMETERS (INCHES) UNLESS OTHERWISE NOTED.

SUBGRADE REPLACEMENT 97.4

REVISED 4-23-93

DATE: 4/23/93
 DRAWN BY: [illegible]
 CHECKED BY: [illegible]
 APPROVED BY: [illegible]

DATE: 10/10/06
 DRAWN BY: J. M. M. M. M. M.
 CHECKED BY: J. M. M. M. M. M.
 PROJECT: 40800050

HOT-MIX ASPHALT APPROACHES & MAILBOX RETURNS FOR TWO LIFT (3P) RESURFACING PROJECTS

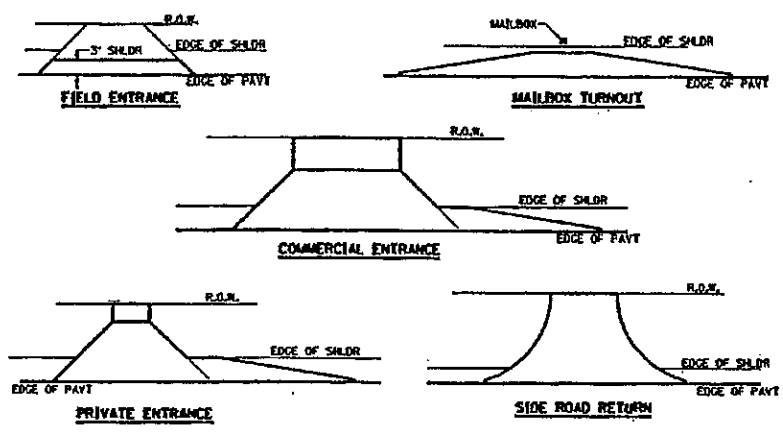

- NOTE 1** EXISTING HMA PE's, CE's, SR's, & MB TURNOUTS
Place 2 1/4" Incidental Hot-Mix Asphalt Surfacing #40800050 on entrance to conform to the existing configuration.
- EXISTING AGG. PE's & CE's**
Place 2" Incidental Hot-Mix Asphalt Surfacing #40800050 on existing entrance to conform to the present configuration.
- EXISTING AGG. SIDEROADS**
Place 3" Incidental Hot-Mix Asphalt Surfacing #40800050 on sideroad to conform to the present configuration.

EXISTING AGG. MAILBOX TURNOUTS
Existing Agg. Mailbox Turnouts shall be constructed as shown below.

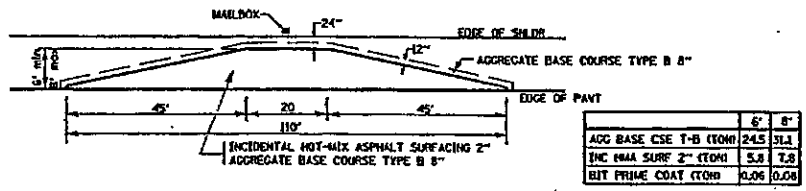

HOT-MIX ASPHALT APPROACHES & MAILBOX RETURNS FOR TWO LIFT (3P) RESURFACING PROJECTS 41.2
REVISED 10-10-06

SECTION 02 SPRING RS 2007-2 CONTRACT NO. 64031

F.A.P. FILE	SECTION	COUNTY	TOTAL SHEETS	NO.	SHEET NO.
309	*	WHITESIDE	38	34	
STA. TO STA.					
FED. ROAD DIST. NO. ILLINOIS FED. AID PROJECT					

11/27/91
 11/27/91
 11/27/91
 11/27/91

ROUGH GROOVED SURFACE SIGN

ILLINOIS STANDARD W8-1107
 SIGN PANEL TYPE 1



COLOR: LEGEND AND BORDER - BLACK NON-REFLECTIVE
 BACKGROUND - ORANGE REFLECTORIZED

SIGN SIZE	DIMENSIONS							
	A	B	C	D	E	F	G	H
1200x1200 (48x48)	1200 (48.0)	600 (24.0)	75 (3.0)	850 (33.5)	825 (32.5)	150 (6.0)	325 (13.0)	88 (3.5)

SIGN SIZE	SERIES LINES			MARGIN	BORDER	BLANK STD.
	1	2	3			
1200x1200 (48x48)	7C	7C	7C	20 (0.8)	30 (1.2)	B4-460

ALL DIMENSIONS IN INCHES.

GENERAL NOTES

SIGN PANELS AND FACE MATERIALS SHALL BE ACCORDING TO SECTION 120 OF THE STANDARD SPECIFICATIONS
 METAL POSTS SHALL BE IN ACCORDANCE WITH STD. T20011.

ALL MOUNTING HARDWARE SHALL BE ALUMINUM, STAINLESS STEEL, ZINC OR CADMIUM PLATED STEEL AND SHALL BE INCIDENTAL TO THE COST OF THE INSTALLATION.

ALL DIMENSIONS ARE IN MILLIMETERS (INCHES) UNLESS OTHERWISE NOTED.

ROUGH GROOVED SURFACE SIGN

91.2

REVISION 1-27-91

SECTION D2 SPRING RS 2007-2

CONTRACT NO. 64031

F.A.P. RITE	SECTION	COUNTY	TOTAL SHEET NO.
309	*	WHITESIDE	38
STL	TO STA.		35
FED. ROAD DIST. NO.	ILLINOIS	FED. AID PROJECT	

HOT-MIX ASPHALT APPROACHES & MAILBOX RETURNS

SECTION D2 SPRING RS 2007-2 CONTRACT NO. 64031

F&P RITE	SECTION	COUNTY	TOTAL SHEET NO.
309		WHITESIDE	38
STA.	TO STA.	FED. AID PROJECT	

2"=100' HORIZONTAL DISTANCE

APPROACH	TYPE	WIDTH	LENGTH
APPROACH	TYPE	WIDTH	LENGTH

400 BASE C&G 1 1/2" STOW	22.2	22.2
1/2" HOT MIX SURF 50(12) STOW	24.5	24.5
1/2" HOT MIX COAT STOW	0.25	0.25
	0.000	0.000

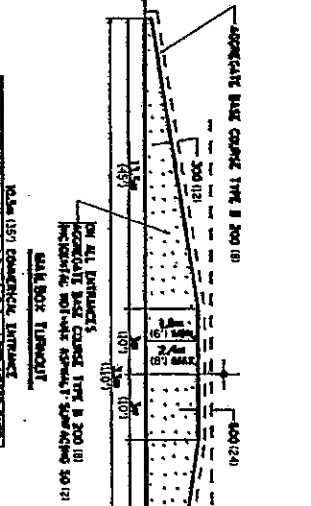
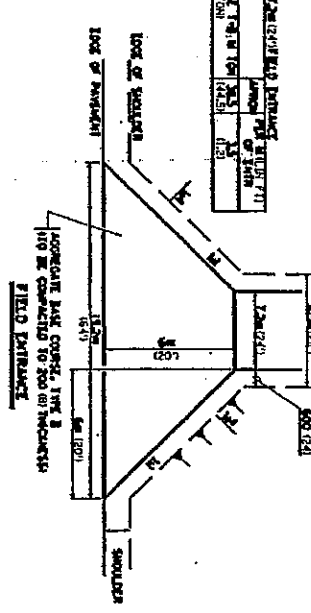

2"=100' HORIZONTAL DISTANCE

APPROACH	TYPE	WIDTH	LENGTH
APPROACH	TYPE	WIDTH	LENGTH

- NOTE:**
- ① QUANTITIES ARE TO BE CONSIDERED FOR THE APPROACH SIZE OF ALL 'A' & 'C' REQUIREMENTS IF A MAILBOX IS INSTALLED.
 - ② ALL 'A' & 'C' ARE TO BE SPACED TO RIGHT OF SURF LINE AND BOUND RIGHT OF SURF SHALL MATCH EXISTING SHOULDERS.
 - ③ IF ANY TO BE APPROXIMATE TO RIGHT OF SURF OR TOP OF DRAIN, WHICH EVER IS GOVERNATIVE.
 - ④ QUANTITIES ARE CALCULATED WITH 1" BIRMINGHAM SHOULDER IN PLACE. APPROXIMATE QUANTITIES SHOWN ARE FOR THE BEST CONSTRUCTION.
 - ⑤ INCENTIVE REWARDS FOR PLACEMENT OF APPROACH BASE COURSE SHALL BE CONSIDERED INCENTIVE TO THE APPROACH BASE COURSE.
 - ⑥ ALL DIMENSIONS ARE IN FEET AND INCHES (UNLESS OTHERWISE NOTED).

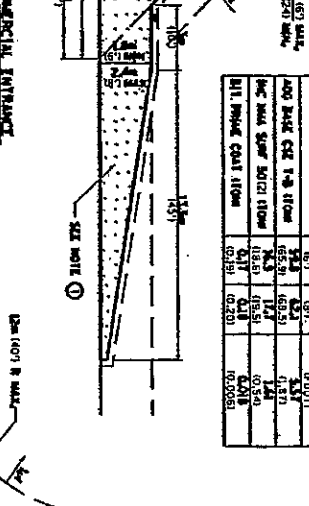
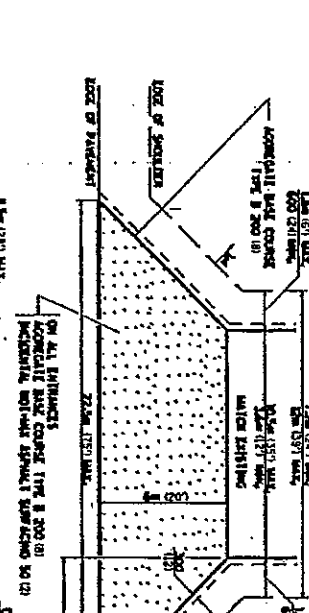

- NOTE:**
- ① ALL DIMENSIONS ARE IN FEET AND INCHES (UNLESS OTHERWISE NOTED).
 - ② QUANTITIES ARE TO BE CONSIDERED FOR THE APPROACH SIZE OF ALL 'A' & 'C' REQUIREMENTS IF A MAILBOX IS INSTALLED.
 - ③ ALL 'A' & 'C' ARE TO BE SPACED TO RIGHT OF SURF LINE AND BOUND RIGHT OF SURF SHALL MATCH EXISTING SHOULDERS.
 - ④ IF ANY TO BE APPROXIMATE TO RIGHT OF SURF OR TOP OF DRAIN, WHICH EVER IS GOVERNATIVE.
 - ⑤ QUANTITIES ARE CALCULATED WITH 1" BIRMINGHAM SHOULDER IN PLACE. APPROXIMATE QUANTITIES SHOWN ARE FOR THE BEST CONSTRUCTION.
 - ⑥ INCENTIVE REWARDS FOR PLACEMENT OF APPROACH BASE COURSE SHALL BE CONSIDERED INCENTIVE TO THE APPROACH BASE COURSE.
 - ⑦ ALL DIMENSIONS ARE IN FEET AND INCHES (UNLESS OTHERWISE NOTED).

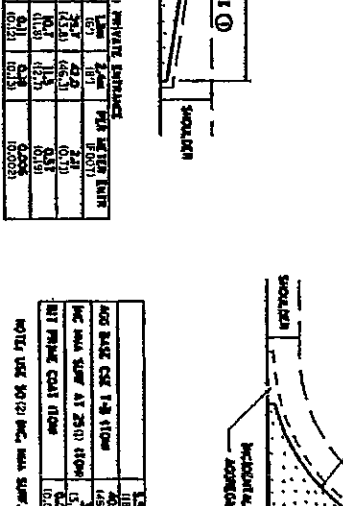
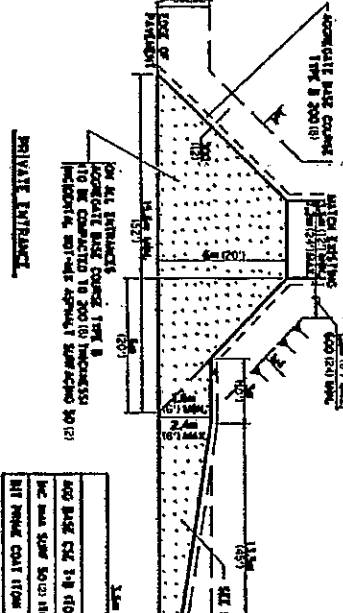

2"=100' HORIZONTAL DISTANCE

APPROACH	TYPE	WIDTH	LENGTH
APPROACH	TYPE	WIDTH	LENGTH

TYPICAL PAVEMENT MARKINGS

SECTION 02 SPRING RS 2007-2 CONTRACT NO. 64031

F.A.P. RITE	SECTION	COUNTY	TOTAL SHEET NO.
309	*	WHITESIDE	38
STA.		TO STA.	57

FED. ROAD DIST. NO. [ILLINOIS] FED. AID PROJECT

TYPICAL PAVEMENT MARKING FOR FLUSH MEDIAN AT LEFT TURN LANE

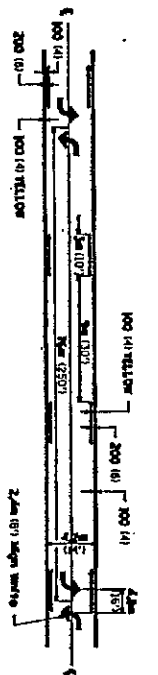
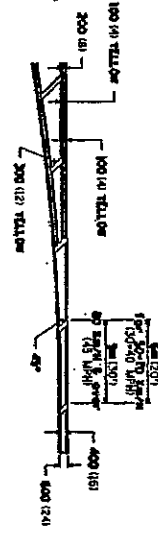
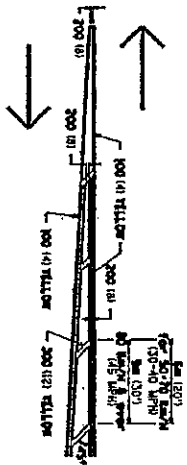

MEDIAN PAVEMENT MARKING

TYPICAL ISLAND OFFSET SHOULDER WIDTH

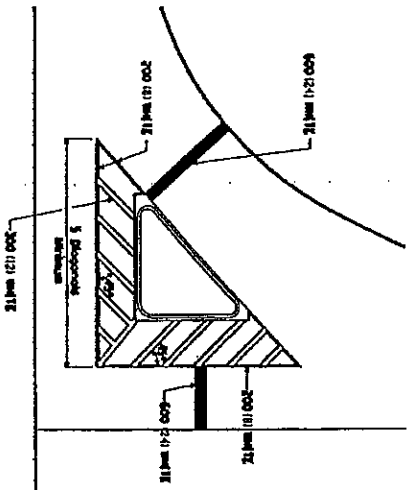

TYPICAL PARKING SPACING

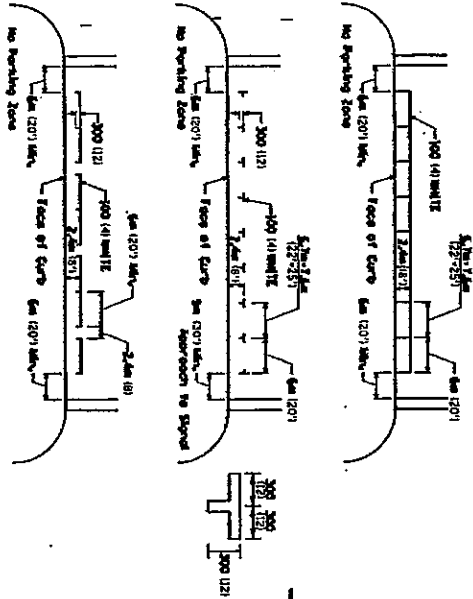

STANDARD CROSSWALK MARKING

See Schedules for Locations

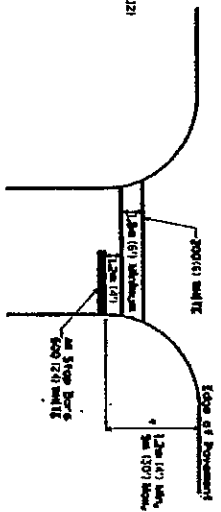

* Reference to the nearest edge of the intersecting roadway to the outside of a marked crosswalk.

TYPICAL PAVEMENT MARKINGS

ARROW LAYOUT

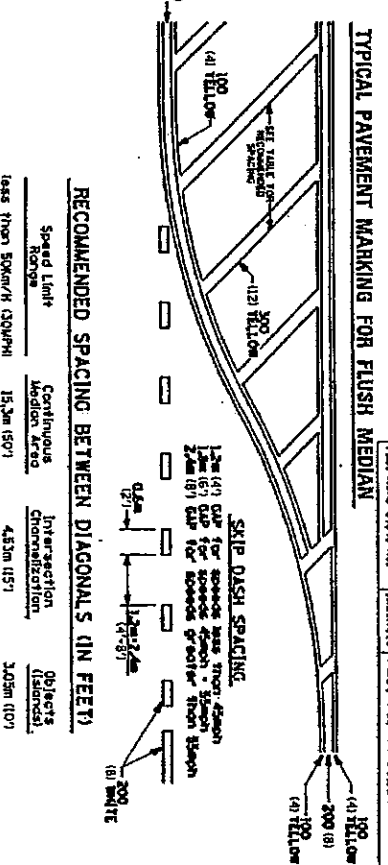
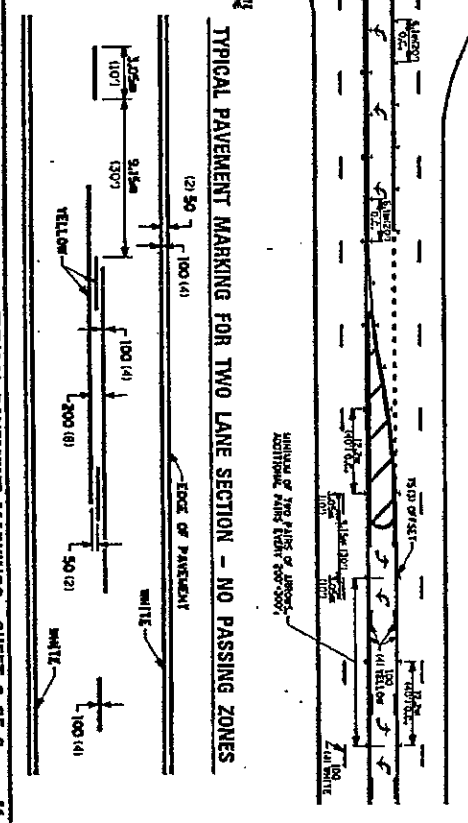
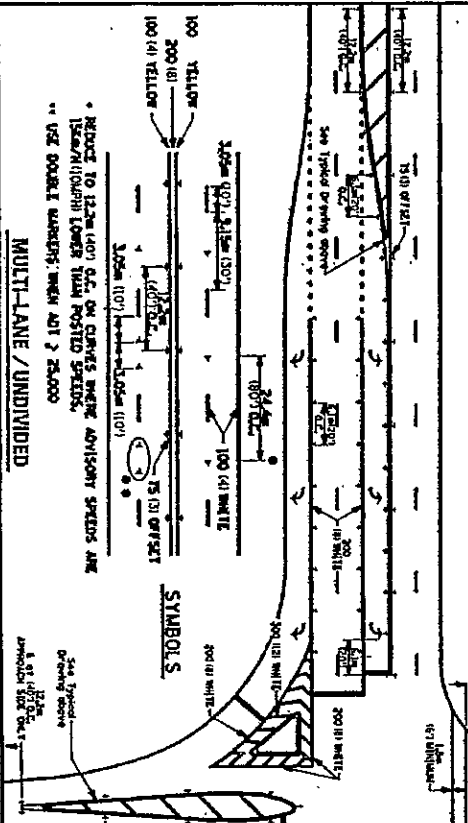
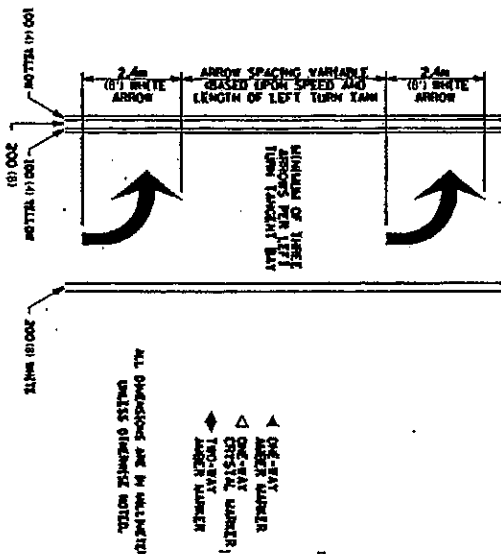

RECOMMENDED SPACING BETWEEN DIAGONALS (IN FEET)

Speed Limit Range	Continous Median Area	Intersection Classification	Objects (Blended)
Less than 50km/h (30MPH)	15.2m (50')	4.53m (15')	3.05m (10')
50-60km/h (30-40MPH)	22.9m (75')	6.1m (20')	4.53m (15')
70km/h (45MPH) & over	22.9m (75')	9.05m (30')	6.1m (20')

NOTE: If the spacing recommended in the Table does not permit of larger five diagonal lines in the order being marked, the spacing from the Table may be increased to the next larger spacing recommended in the Table. The spacing may be increased provided to the pavement center line.

SECTION D2 SPRING RS 2007-2 CONTRACT NO. 64031

F.A.P. RITE#	SECTION	COUNTY	TOTAL SHEETS NO.
309		WHITESIDE	38

TO STA. ILLINOIS FED. AID PROJECT

ILLINOIS DEPARTMENT OF LABOR

PREVAILING WAGES FOR WHITESIDE COUNTY EFFECTIVE OCTOBER 2007

The Prevailing rates of wages are included in the Contract proposals which are subject to Check Sheet #5 of the Supplemental Specifications and Recurring Special Provisions. The rates have been ascertained and certified by the Illinois Department of Labor for the locality in which the work is to be performed and for each craft or type of work or mechanic needed to execute the work of the Contract. As required by Prevailing Wage Act (820 ILCS 130/0.01, et seq.) and Check Sheet #5 of the Contract, not less than the rates of wages ascertained by the Illinois Department of Labor and as revised during the performance of a Contract shall be paid to all laborers, workers and mechanics performing work under the Contract. Post the scale of wages in a prominent and easily accessible place at the site of work.

If the Illinois Department of Labor revises the prevailing rates of wages to be paid as listed in the specification of rates, the contractor shall post the revised rates of wages and shall pay not less than the revised rates of wages. Current wage rate information shall be obtained by visiting the Illinois Department of Labor web site at <http://www.state.il.us/agency/idol/> or by calling 312-793-2814. It is the responsibility of the contractor to review the rates applicable to the work of the contract at regular intervals in order to insure the timely payment of current rates. Provision of this information to the contractor by means of the Illinois Department of Labor web site satisfies the notification of revisions by the Department to the contractor pursuant to the Act, and the contractor agrees that no additional notice is required. The contractor shall notify each of its subcontractors of the revised rates of wages.

Whiteside County Prevailing Wage for October 2007

Trade Name	RG	TYP	C	Base	FRMAN	*M-F>8	OSA	OSH	H/W	Pensn	Vac	Trng
=====	==	==	=	=====	=====	=====	==	==	=====	=====	=====	=====
ASBESTOS ABT-GEN		BLD		25.110	26.110	1.5	1.5	2.0	6.540	9.630	0.000	0.600
ASBESTOS ABT-MEC		BLD		18.750	19.750	1.5	1.5	2.0	4.750	2.000	0.000	0.000
BOILERMAKER		BLD		30.970	33.970	2.0	2.0	2.0	8.270	7.740	0.000	0.300
BRICK MASON		BLD		31.000	33.500	1.5	1.5	2.0	5.900	9.690	0.000	0.460
CARPENTER		BLD		28.490	31.620	1.5	1.5	2.0	6.100	9.220	0.000	0.600
CARPENTER		HWY		28.640	30.390	1.5	1.5	2.0	6.300	8.680	0.000	0.400
CEMENT MASON		ALL		30.500	33.000	1.5	1.5	2.0	5.900	9.030	0.000	0.150
CERAMIC TILE FNSHER		BLD		26.670	0.000	1.5	1.5	2.0	5.900	4.000	0.000	0.390
COMMUNICATION TECH	E	BLD		30.250	32.500	1.5	1.5	2.0	8.600	8.690	0.000	0.610
ELECTRIC PWR EQMT OP		ALL		29.180	37.490	1.5	1.5	2.0	4.750	8.180	0.000	0.220
ELECTRIC PWR GRNDMAN		ALL		22.610	37.490	1.5	1.5	2.0	4.750	6.330	0.000	0.170
ELECTRIC PWR LINEMAN		ALL		34.710	37.490	1.5	1.5	2.0	4.750	9.720	0.000	0.260
ELECTRIC PWR TRK DRV		ALL		23.350	37.490	1.5	1.5	2.0	4.750	6.540	0.000	0.180
ELECTRICIAN	E	BLD		34.920	38.410	1.5	1.5	2.0	8.600	12.05	0.000	0.700
ELECTRICIAN	W	BLD		29.520	31.520	1.5	1.5	2.0	5.500	7.810	0.000	0.310
ELECTRONIC SYS TECH	W	BLD		19.800	21.400	1.5	1.5	2.0	5.880	4.040	0.000	0.310
ELEVATOR CONSTRUCTOR		BLD		33.140	37.280	2.0	2.0	2.0	8.275	6.060	1.990	0.000
GLAZIER		BLD		21.280	22.560	1.5	1.5	2.0	5.300	4.150	0.000	0.250
HT/FROST INSULATOR		BLD		25.860	27.060	1.5	1.5	2.0	4.800	7.500	0.000	0.000
IRON WORKER	E	ALL		31.190	32.790	2.0	2.0	2.0	7.200	16.97	0.000	1.200
IRON WORKER	W	ALL		24.500	26.460	1.5	1.5	2.0	8.140	8.440	0.000	0.420
LABORER		BLD		25.110	26.110	1.5	1.5	2.0	6.540	9.630	0.000	0.600
LABORER		HWY		24.660	25.410	1.5	1.5	2.0	6.540	9.230	0.000	0.600
LABORER, SKILLED		HWY		26.210	26.960	1.5	1.5	2.0	6.540	9.230	0.000	0.600
LATHER		BLD		28.490	31.620	1.5	1.5	2.0	6.100	9.220	0.000	0.600
MACHINIST		BLD		38.390	40.390	2.0	2.0	2.0	4.880	6.550	2.650	0.000
MARBLE FINISHERS		BLD		26.670	0.000	1.5	1.5	2.0	5.900	4.000	0.000	0.390
MARBLE MASON		BLD		29.910	30.160	1.5	1.5	2.0	5.900	5.500	0.000	0.420
MILLWRIGHT		BLD		33.650	37.020	1.5	1.5	2.0	6.100	11.10	0.000	0.560
OPERATING ENGINEER	E	BLD	1	37.050	41.050	2.0	2.0	2.0	6.850	6.150	1.900	0.700
OPERATING ENGINEER	E	BLD	2	36.350	41.050	2.0	2.0	2.0	6.850	6.150	1.900	0.700
OPERATING ENGINEER	E	BLD	3	33.900	41.050	2.0	2.0	2.0	6.850	6.150	1.900	0.700
OPERATING ENGINEER	E	BLD	4	31.900	41.050	2.0	2.0	2.0	6.850	6.150	1.900	0.700
OPERATING ENGINEER	E	HWY	1	36.900	40.900	1.5	1.5	2.0	6.850	6.150	1.900	0.700
OPERATING ENGINEER	E	HWY	2	36.350	40.900	1.5	1.5	2.0	6.850	6.150	1.900	0.700
OPERATING ENGINEER	E	HWY	3	35.050	40.900	1.5	1.5	2.0	6.850	6.150	1.900	0.700
OPERATING ENGINEER	E	HWY	4	33.600	40.900	1.5	1.5	2.0	6.850	6.150	1.900	0.700
OPERATING ENGINEER	E	HWY	5	32.150	40.900	1.5	1.5	2.0	6.850	6.150	1.900	0.700
OPERATING ENGINEER	W	BLD	1	26.150	0.000	1.5	1.5	2.0	6.850	5.800	1.500	0.550
OPERATING ENGINEER	W	BLD	2	23.500	0.000	1.5	1.5	2.0	6.850	5.800	1.500	0.550
OPERATING ENGINEER	W	BLD	3	22.450	0.000	1.5	1.5	2.0	6.850	5.800	1.500	0.550
OPERATING ENGINEER	W	HWY	1	26.150	27.150	1.5	1.5	2.0	6.850	5.800	1.500	0.550
OPERATING ENGINEER	W	HWY	2	24.550	27.150	1.5	1.5	2.0	6.850	5.800	1.500	0.550
OPERATING ENGINEER	W	HWY	3	23.400	27.150	1.5	1.5	2.0	6.850	5.800	1.500	0.550
PAINTER		ALL		24.270	25.270	1.5	1.5	1.5	4.700	4.850	0.000	0.600
PAINTER OVER 30FT		ALL		25.520	26.520	1.5	1.5	1.5	4.700	4.850	0.000	0.600
PAINTER PWR EQMT		ALL		24.770	25.770	1.5	1.5	1.5	4.700	4.850	0.000	0.600
PILEDRIVER		BLD		29.490	32.730	1.5	1.5	2.0	6.100	9.220	0.000	0.600
PILEDRIVER		HWY		28.640	30.390	1.5	1.5	2.0	6.300	8.680	0.000	0.400
PIPEFITTER		ALL		30.780	33.860	1.5	1.5	2.0	4.900	8.210	0.000	0.550
PLASTERER		BLD		30.540	33.590	2.0	2.0	2.0	5.900	8.300	0.000	0.150
PLUMBER		ALL		30.780	33.860	1.5	1.5	2.0	4.900	8.210	0.000	0.550
ROOFER		BLD		22.850	24.100	1.5	1.5	2.0	5.840	4.870	0.000	0.190
SHEETMETAL WORKER		BLD		32.440	34.370	1.5	1.5	2.0	5.000	11.34	0.520	0.290
SPRINKLER FITTER		BLD		31.240	33.240	1.5	1.5	2.0	6.500	5.350	0.000	0.250
STONE MASON		BLD		31.000	33.500	1.5	1.5	2.0	5.900	9.690	0.000	0.460
TERRAZZO FINISHER		BLD		26.670	0.000	1.5	1.5	2.0	5.900	4.000	0.000	0.390
TERRAZZO MASON		BLD		29.910	30.160	1.5	1.5	2.0	5.900	5.500	0.000	0.420

TILE LAYER	BLD	28.490	31.620	1.5	1.5	2.0	6.100	9.220	0.000	0.600
TILE MASON	BLD	29.910	30.160	1.5	1.5	2.0	5.900	5.500	0.000	0.420
TRUCK DRIVER	ALL 1	26.655	0.000	1.5	1.5	2.0	7.900	3.550	0.000	0.000
TRUCK DRIVER	ALL 2	27.055	0.000	1.5	1.5	2.0	7.900	3.550	0.000	0.000
TRUCK DRIVER	ALL 3	27.255	0.000	1.5	1.5	2.0	7.900	3.550	0.000	0.000
TRUCK DRIVER	ALL 4	27.505	0.000	1.5	1.5	2.0	7.900	3.550	0.000	0.000
TRUCK DRIVER	ALL 5	28.255	0.000	1.5	1.5	2.0	7.900	3.550	0.000	0.000
TRUCK DRIVER	O&C 1	21.320	0.000	1.5	1.5	2.0	7.900	3.550	0.000	0.000
TRUCK DRIVER	O&C 2	21.640	0.000	1.5	1.5	2.0	7.900	3.550	0.000	0.000
TRUCK DRIVER	O&C 3	21.800	0.000	1.5	1.5	2.0	7.900	3.550	0.000	0.000
TRUCK DRIVER	O&C 4	22.000	0.000	1.5	1.5	2.0	7.900	3.550	0.000	0.000
TRUCK DRIVER	O&C 5	22.600	0.000	1.5	1.5	2.0	7.900	3.550	0.000	0.000
TUCKPOINTER	BLD	31.000	33.500	1.5	1.5	2.0	5.900	9.690	0.000	0.460

Legend:

M-F>8 (Overtime is required for any hour greater than 8 worked each day, Monday through Friday.)

OSA (Overtime is required for every hour worked on Saturday)

OSH (Overtime is required for every hour worked on Sunday and Holidays)

H/W (Health & Welfare Insurance)

Pensn (Pension)

Vac (Vacation)

Trng (Training)

Explanations

WHITESIDE COUNTY

ELECTRICIAN AND COMMUNICATION TECHNICIAN(EAST) - Townships of Genessee, Jordan, Hopkins, Sterling, Hume, Montmorency, Tampico, and Hahnaman.

ELECTRONIC SYSTEMS TECHNICIAN (WEST) - Portion west of Genessee, Hume, Mount Pleasant, and Tampico Townships.

IRONWORKERS (EAST) - That part county North and East of a line from Fair Haven (Carroll County) to Rt. 30, then to the East county line.

OPERATING ENGINEERS (WEST) - From the fifth sectional line east of Morrison, running directly north and south.

The following list is considered as those days for which holiday rates of wages for work performed apply: New Years Day, Memorial/Decoration Day, Fourth of July, Labor Day, Veterans Day, Thanksgiving Day, Christmas Day. Generally, any of these holidays which fall on a Sunday is celebrated on the following Monday. This then makes work performed on that Monday payable at the appropriate overtime rate for holiday pay. Common practice in a given local may alter certain days of celebration such as the day after Thanksgiving for Veterans Day. If in doubt, please check with IDOL.

Oil and chip resealing (O&C) means the application of road oils and

liquid asphalt to coat an existing road surface, followed by application of aggregate chips or gravel to coated surface, and subsequent rolling of material to seal the surface.

EXPLANATION OF CLASSES

ASBESTOS - GENERAL - removal of asbestos material/mold and hazardous materials from any place in a building, including mechanical systems where those mechanical systems are to be removed. This includes the removal of asbestos materials/mold and hazardous materials from ductwork or pipes in a building when the building is to be demolished at the time or at some close future date.

ASBESTOS - MECHANICAL - removal of asbestos material from mechanical systems, such as pipes, ducts, and boilers, where the mechanical systems are to remain.

CERAMIC TILE FINISHER, MARBLE FINISHER, TERRAZZO FINISHER

Assisting, helping or supporting the tile, marble and terrazzo mechanic by performing their historic and traditional work assignments required to complete the proper installation of the work covered by said crafts. The term "Ceramic" is used for naming the classification only and is in no way a limitation of the product handled. Ceramic takes into consideration most hard tiles.

COMMUNICATIONS TECHNICIAN - East

Installing, manufacturing, assembling and maintaining sound and intercom, protection alarm (security), fire alarm, master antenna television, closed circuit television, low voltage control for computers and/or door monitoring, school communications systems, telephones and servicing of nurse and emergency calls, and the installation and maintenance of transmit and receive antennas, transmitters, receivers, and associated apparatus which operates in conjunction with above systems. All work associated with these system installations will be included EXCEPT the installation of protective metallic conduit in new construction projects (excluding less than ten-foot runs strictly for protection of cable) and 120 volt AC (or higher) power wiring and associated hardware.

ELECTRONIC SYSTEMS TECHNICIAN - West

Installing, assembling and maintaining sound and intercom, protection alarm (security), master antenna television, closed circuit television, computer hardware and software programming and installation to the network's outlet and input (EXCLUDING all cabling, power and cable termination work historically performed by wiremen), door monitoring and control, nurse and emergency call programming and installation to the system's outlet and input (EXCLUDING all cabling, power and cable termination work historically performed by wiremen), clock and timing; and the installation and maintenance of transmit and receive antennas, transmitters, receivers, and associated apparatus which operates in conjunction with the above systems. All work associated with these system installations will be included EXCEPT (1) installation of protective metallic conduit, excluding less than ten-foot runs strictly for protection of cable, and (2) 120 volt AC (or higher) power wiring and associated hardware.

LABORER, SKILLED - HIGHWAY

Individuals engaged in the following types of work, irrespective of the site of the work: asbestos abatement worker, handling of any materials with any foreign matter harmful to skin or clothing, track

laborer, cement handlers, chloride handlers, the unloading and loading with steel workers and re-bars, concrete workers wet, tunnel helpers in free air, batch dumpers, mason tenders, kettle and tar men, tank cleaners, plastic installers, scaffold workers, motorized buggies or motorized unit used for wet concrete or handling of building materials, laborers with de-watering systems, sewer workers plus depth, rod and chainmen with technical engineers, rod and chainmen with land surveyors, rod and chainmen with surveyors, vibrator operators, cement silica, clay, fly ash, lime and plasters, handlers (bulk or bag), cofferdam workers plus depth, on concrete paving, placing, cutting and tying of reinforcing, deck hand, dredge hand, and shore laborers, bankmen on floating plant, grade checker, power tools, front end man on chip spreaders, cession workers plus depth, gunnite nozzle men, lead man on sewer work, welders, cutters, burners and torchmen, chainsaw operators, jackhammer and drill operators, layout man and/or drainage tile layer, steel form setter - street and highway, air tamping hammermen, signal man on crane, concrete saw operator, screedman on asphalt pavers, laborers tending masons with hot material or where foreign materials are used, mortar mixer operators, multiple concrete duct - leadsman, lumen, asphalt raker, curb asphalt machine operator, ready mix scalemen (permanent, portable or temporary plant), laborers handling masterplate or similar materials, laser beam operator, concrete burning machine operator, coring machine operator, plaster tender, underpinning and shoring of buildings, pump men, manhole and catch basin, dirt and stone tamper, hose men on concrete pumps, hazardous waste worker, lead base paint abatement worker, lining of pipe, refusing machine, assisting on direct boring machine, the work of laying watermain, fire hydrants, all mechanical joints to watermain work, sewer worker, and tapping water service and forced lift station mechanical worker.

TRUCK DRIVER - BUILDING, HEAVY AND HIGHWAY CONSTRUCTION

Class 1. Drivers on 2 axle trucks hauling less than 9 ton. Air compressor and welding machines and brooms, including those pulled by separate units, truck driver helpers, warehouse employees, mechanic helpers, greasers and tiremen, pickup trucks when hauling materials, tools, or workers to and from and on-the-job site, and fork lifts up to 6,000 lb. capacity.

Class 2. Two or three axle trucks hauling more than 9 ton but hauling less than 16 ton. A-frame winch trucks, hydrolift trucks, vector trucks or similar equipment when used for transportation purposes. Fork lifts over 6,000 lb. capacity, winch trucks, four axle combination units, and ticket writers.

Class 3. Two, three or four axle trucks hauling 16 ton or more. Drivers on water pulls, articulated dump trucks, mechanics and working forepersons, and dispatchers. Five axle or more combination units.

Class 4. Low Boy and Oil Distributors.

Class 5. Drivers who require special protective clothing while employed on hazardous waste work.

TRUCK DRIVER - OIL AND CHIP RESEALING ONLY.

This shall encompass laborers, workers and mechanics who drive contractor or subcontractor owned, leased, or hired pickup, dump, service, or oil distributor trucks. The work includes transporting materials and equipment (including but not limited to, oils, aggregate supplies, parts, machinery and tools) to or from the job site; distributing oil or liquid asphalt and aggregate; stock piling

material when in connection with the actual oil and chip contract. The Truck Driver (Oil & Chip Resealing) wage classification does not include supplier delivered materials.

OPERATING ENGINEERS - BUILDING - EAST

Class 1. Assistant Craft Foreman; Craft Foreman; Mechanic; Asphalt Plant; Asphalt Spreader; Autograde; Batch Plant; Benoto (requires Two Engineers); Boiler and Throttle Valve; Caisson Rigs; Central Redi-Mix Plant; Combination Back Hoe Front End-loader Machine; Compressor and Throttle Valve; Concrete Breaker (Truck Mounted); Concrete Conveyor; Concrete Paver; Concrete Placer; Concrete Pump (Truck Mounted); Concrete Tower, Cranes, All, Cranes, Hammerhead, Creter Crane; Crusher, Stone, etc.; Derricks, All; Derricks, Traveling; Formless Curb and Gutter Machine; Grader, Elevating; Grouting Machines; Highlift Shovels or Front Endloader 2-1/4 yd. and over; Hoists, Elevators, outside type rack and pinion and similar machines; Hoists, one, two and three Drum; Hoists, Two tigger One Floor; Hydraulic Backhoes; Hydraulic Boom Trucks; Locomotives, All; Motor Patrol; Pile Drivers and Skid Rig; Post Hole Digger; Pre-Stress Machine; Pump Cretes; Squeeze Cretes-screw Type Pumps; Gypsum Bulker and Pump; Raised and Blind Hole Drill; Rock Drill; Roto Mill Grinder; Scoops - Tractor Drawn; Slip-form Paver; Straddle Buggies; Tie Back Machine; Tractor with Book and Side Boom; Trenching Machines.

Class 2. Bobcat (over 3/4 cu. yd.); Boilers Brick Forklift; Broom, All Power Propelled; Bulldozers; Concrete Mixer (Two Bag and Over); Conveyor, Portable; Forklift Trucks; Greaser Engineer; Highlift Shovels or Front Endloaders under 2-1/4 yd.; Hoists, Automatic; Hoists, Sewer Dragging Machine; Hoists, Tigger Single Drum; Rollers, All; Steam Generators; Tractors, All; Tractor Drawn Vibratory Roller; Winch Trucks with "A" Frame.

Class 3. Air Compressor; Asphalt Spreader; Combination - Small Equipment Operator; Generators; Heaters, Mechanical; Hoists, Inside Elevators - (Rheostat Manual Controlled); Hydraulic Power Units (Pile Driving and Extracting); Pumps, over 3" (1 to 3 not to exceed a total of 300 ft.); Pumps, Well Points; Welding Machines (2 through 5); Winches, 4 small Electric Drill Winches; Bobcat (up to and including 3/4 cu. yd.).

Class 4. Hoists, Inside Elevators, Push Button with Automatic Doors; Oilers; Brick Forklift.

OPERATING ENGINEERS - HEAVY AND HIGHWAY CONSTRUCTION - EAST

Class 1. Craft Foreman; Asphalt Plant, Asphalt Heater and Planer Combination; Asphalt Heater Scarfire; Asphalt Silo Tender; Asphalt Spreader; Autograder; ABG Paver; Backhoes with Caisson attachment; Ballast Regulator, Belt Loader; Caisson Rigs; Car Dumper; Central Redi-Mix Plant; Backhoe w/shear attachments; Combination Backhoe Front Endloader Machine, (1 cu. yd. Backhoe Bucket or over or with attachments); Concrete Breaker (Truck Mounted); Concrete Conveyor; Concrete Paver over 27E cu. ft.; Concrete Placer; Concrete Tube Float; Cranes, all attachments; Cranes, Hammerhead, Linden, Peco & Machines of a like nature; Crete Crane; Crusher, Stone, etc.; Derricks, All; Derrick Boats; Derricks, Traveling; Directional Boring Machine over 12"; Dredges; Field Mechanic-Welder; Formless Curb and Gutter Machine; Gradall and Machines of a like nature; Grader, Elevating; Grader, Motor Grader, Motor Patrol, Auto Patrol, Form Grader, Pull Grader, Subgrader; Guard Rail Post Driver Mounted; Hoists, One, Two and Three Drum; Hydraulic Backhoes; Pile Drivers and Skid Rig; Pre-Stress Machine; Pump Cretes Dual Ram; Rock Drill - Crawler or

Skid Rig; Rock Drill - Truck Mounted; Rock/Track Tamper; Roto Mill Grinder; Slip-Form Paver; Soil Test Drill Rig (Truck Mounted); Straddle Buggies; GCI Crane; Hydraulic Telescoping form (Tunnel); Tie Back Machine; Tractor Drawn Belt Loader; Tractor with Boom; Tractor-aire with Attachments; Traffic Barrier conveyor machine; Raised or Blind Hole; Trenching Machine; Truck Mounted Concrete Pump with Boom; Truck Mounted Concrete Conveyor; Underground Boring and/or Mining Machines; Wheel Excavator; Widener (APSCO).

Class 2. Batch Plant; Bituminous Mixer; Boiler and Throttle Valve; Bulldozers; Car Loader Trailing Conveyors; Combination Backhoe Front Endloader Machine (less than 1 cu. yd. Backhoe Bucket or over or with attachments); Compressor and Throttle Valve; Compressor, Common Receiver (3); Concrete Breaker or Hydro Hammer; Concrete Grinding Machine; Concrete Mixer or Paver 7S Series to and including 27 cu. ft.; Concrete Spreader; Concrete Curing Machine, Burlap Machine, Belting Machine and Sealing Machine; Conveyor Muck Cars (Haglund or Similar Type); Drills, all; Finishing Machine - Concrete; Greaser Engineer; Highlift Shovels or Front Endloader; Hoist - Sewer Dragging Machine; Hydraulic Boom Trucks (All Attachments); Hydro Blaster; Laser Screed; All Locomotives, Dinky; Pump Cretes; Squeeze Cretes-Screw Type Pumps, Gypsum Bulker and Pump; Roller, Asphalt; Rotary Snow Plows; Rototiller, Seaman, etc., self-propelled; Scoops - Tractor Drawn; Self-Propelled Compactor; Spreader - Chip - Stone, etc.; Scraper; Scraper - Prime Mover in Tandem (Regardless of Size); Tank Car Heater; Tractors, Push, Pulling Sheeps Foot, Disc, Compactor, etc. Tug Boats.

Class 3. Boilers; Brooms, All Power Propelled; Cement Supply Tender; Compressor, Common Receiver (2); Concrete Mixer (Two Bag and Over); Conveyor, Portable; Farm-Type Tractors Used for Mowing, Seeding, etc.; Fireman on Boilers; Forklift Trucks; Grouting Machine; Hoists, Automatic; Hoists, All Elevators; Hoists, Tugger Single Drum; Jeep Diggers, Low Boys; Pipe Jacking Machines; Post-Hole Digger; Power Saw, Concrete Power Driven; Pug Mills; Rollers, other than asphalt; Seed and Straw Blower; Steam Generators; Stump Machine; Winch Trucks with "A" Frame; Work Boats; Tamper - Form-Motor Driven.

Class 4. Air Compressor - Small and Large; Asphalt Spreader, Backend Man; Bobcat (Skid Steer) all; Combination - Small Equipment Operator; Directional Boring Machine up to 12"; Generators - Small 50kw and Under; Generators - Large over 50kw; Heaters, Mechanical; Hydraulic Power Unit (Pile Driving, Extracting, or Drilling); Hydro-Blaster; Light Plants, All (1 through 5); Pumps, over 3" (1 to 3 not to exceed a total of 300 ft.); Pumps, Well Points; Tract-aire; Welding Machines (2 through 5); Winches, 4 Small Electric Drill Winches.

Class 5. Oilers and Directional Boring Machine Locator.

OPERATING ENGINEERS - BUILDING, HEAVY AND HIGHWAY CONSTRUCTION - WEST

Class 1. An engineer on Crane, Shovel, Clamshell, Dragline, Backhoe, Derrick, Tower Crane, Cable Way, Concrete Spreader (servicing two pavers), Asphalt Spreader, Asphalt Mixer, Plant Engineer, Dipper Dredge Operator, Dipper Dredge Craneman, Dual Purpose Truck (boom or winch), Leverman or Engineman (hydraulic dredge), Mechanic, Paving Mixer with tower attached, Pile Driver, Boom Tractor, Stationary, Portable or Floating Mixing Plant, Trenching Machine (over 40 H.P.), Building Hoist (two drums), Hot Paint Wrapping Machine, Cleaning and Priming Machine, Backfiller (throw bucket), Locomotive Engineer, Qualified Welder, Tow or Push Boat, Concrete Paver, Seaman Trav-L-Plant or similar machines, CMI Autograder or similar machines, Slip Form Paver, Caisson Augering Machine, Mucking Machine, Asphalt Heater-Planer Unit, Hydraulic Cranes, Mine Hoists. An engineer on

Athey, Barber-Green, Euclid or Haiss Loader, Asphalt Pug Mill, Fireman and Drier, Concrete Pump, Concrete Spreader (servicing one paver) Bulldozer, Endloader, Log Chippers or similar machines, Elevating Grader, Group Equipment Greaser, LeTourneaul and similar machines, off-road haul units, DW-10 Hyster Winch and similar machines, Motor Patrol, Power Blade, Push Cat, Tractor Pulling elevating Grader or Power Blade, Tractor Operating Scoop or Scraper, Tractor with Power Attachment, Roller on Asphalt or Blacktop, Single Drum Hoist, Jaeger Mix and Place Machine, Pipe Bending Machine, Flexaplane or similar machines, Automatic Curbing Machines, Automatic Cement and Gravel Batch Plants (one stop set-up), Seaman Pulvi-Mixer or similar machines, Blastholer Self-propelled Rotary Drill or similar machines, Work Boat, Combination Concrete Finishing Machine and Float, Self-propelled Sheep Foot Roller or Compactor (used in conjunction with a Grading Spread), Asphalt Spreader Screed Operator, Apsco spreader or similar machine, Slusher, Forklift (over 6000 lb. cap. or working at heights above 28 ft.) Concrete Conveyors, Chip Spreader, Underground Boring Machine (BUILDING ONLY), Straddle Carrier, Hydro-Hammer (BUILDING ONLY), Hydraulic Pumps or Power Units Driven by any power source (except manually), used to hoist or lift machinery or material.

Class 2. An engineer on Asphalt Booster, Fireman and Pump Operator at Asphalt Plant, Mud Jack, Underground Boring Machine (HIGHWAY ONLY), Concrete Finishing Machine, Form Grader with Roller on Earth, Mixers (3 bag to 16E), Power Operated Bull Float, Tractor without Power attachment, Dope Pot (agitating motor), Dope Chop Machine, Distributor (back end), Straddle Carrier, Portable Machine Fireman, Hydro-Hammer (HIGHWAY ONLY), Power Winch on Paving Work, Self-propelled Roller or Compactor (other than provided for above), Pump Operator (more than one well-point pump), Portable Crusher Operator, Trench Machine (under 40 H.P.), Power Subgrader (on forms) or similar machines, Forklift (6000 or less cap.) Gypsum Pump, Conveyor over 20 H.P., Fuller Kenyon Cement Pump or similar machines. An engineer on Air Compressor (400 c.f.m. or over HIGHWAY ONLY), Light Plant, Mixers (1 or 2 bag), Power Batching Machine (Cement Auger or Conveyor), Boiler (Engineer or Fireman), Water Pumps (HIGHWAY ONLY), Mechanical Broom, Automatic Cement and Gravel Batch Plants (two or three stop set-up), Small Rubber-tired Tractors (not including backhoes or endloaders), Self-propelled Curing Machine, Brush Chipper, Driver on Truck Crane or similar machines.

Class 3. Oiler, Mechanic's Helper, Mechanical Heater (other than steam boiler), Belt Machine, Small Outboard Motor Boats (Safety Boat and Life Boat), Engine Driven Welding Machine, and Small Tractors (used to unroll or roll wire mesh), Water pumps (BUILDING ONLY), Air Compressors (BUILDING ONLY), Permanent Automatic Elevators.

Other Classifications of Work:

For definitions of classifications not otherwise set out, the Department generally has on file such definitions which are available. If a task to be performed is not subject to one of the classifications of pay set out, the Department will upon being contacted state which neighboring county has such a classification and provide such rate, such rate being deemed to exist by reference in this document. If no neighboring county rate applies to the task, the Department shall undertake a special determination, such special determination being then deemed to have existed under this determination. If a project requires these, or any classification not listed, please contact IDOL at 618/993-7271 for wage rates or clarifications.

LANDSCAPING

Landscaping work falls under the existing classifications for laborer, operating engineer and truck driver. The work performed by landscape plantsman and landscape laborer is covered by the existing classification of laborer. The work performed by landscape operators (regardless of equipment used or its size) is covered by the classifications of operating engineer. The work performed by landscape truck drivers (regardless of size of truck driven) is covered by the classifications of truck driver.