

DATE	BY
NO.	AREAS CHECKED
NO.	AREAS CHECKED
NO.	AREAS CHECKED

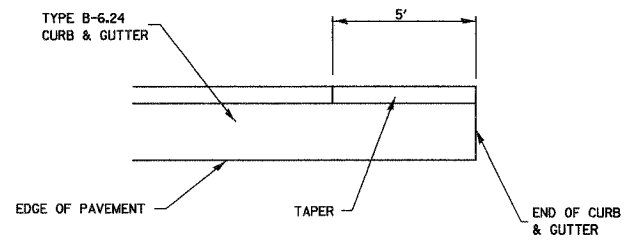

PLAN

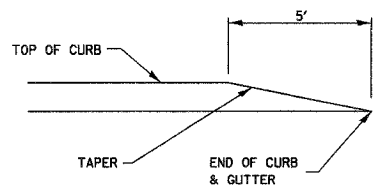

ELEVATION

CURB AND GUTTER TERMINI
N.T.S.

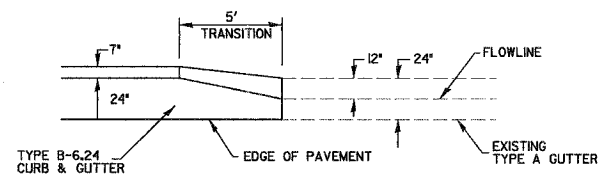

PLAN

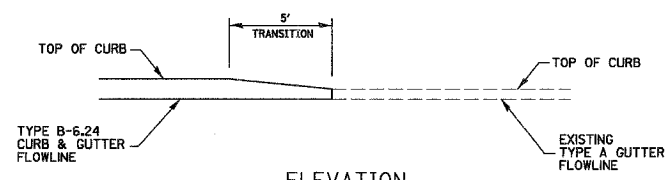

ELEVATION

CURB AND GUTTER TRANSITION
N.T.S.

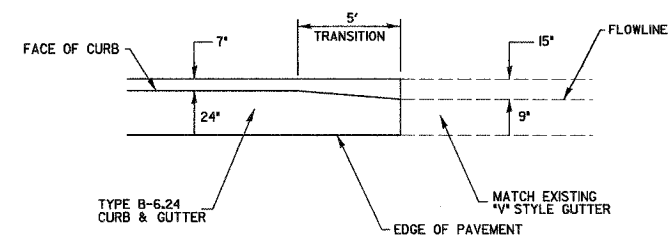

PLAN

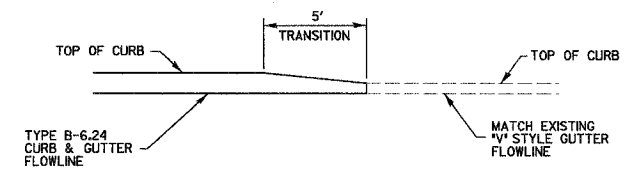

ELEVATION

CURB AND GUTTER TRANSITION
N.T.S.

DATE	BY
NO.	AREAS CHECKED
NO.	AREAS CHECKED

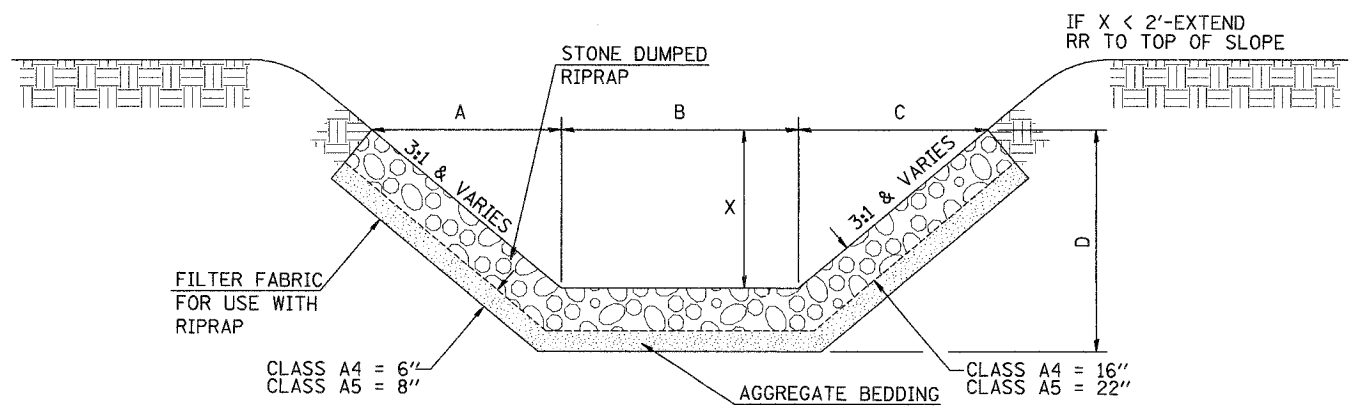

STONED DUMPED RIPRAP DITCH LINING
N.T.S.

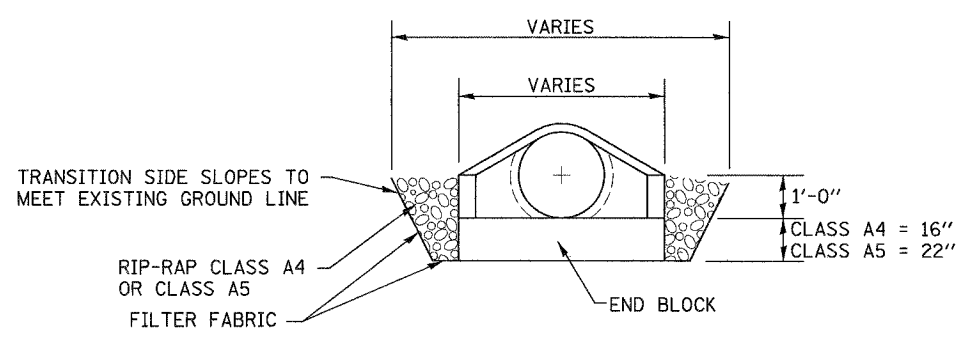

RIP-RAP DETAIL
STORM SEWER OUTFALL
N.T.S.

<p>Juneau Associates, Inc. P.C. CONSULTING ENGINEERS AND LAND SURVEYORS 2101 State Street, P.O. Box 5192 Springfield, IL 62704-5192 Phone: (618) 387-1400 / (618) 452-0550 Fax: (618) 387-0941</p>		<p>MISCELLANEOUS DETAILS</p> <p>F.A.U. ROUTE 8899 GLEN CROSSING ROAD GLEN CARBON, ILLINOIS SECTION No. 03-00026-00-RP</p>																					
<p>REVISIONS</p> <table border="1"> <thead> <tr> <th>NO.</th> <th>DATE</th> <th>BY</th> <th>REMARKS</th> </tr> </thead> <tbody> <tr> <td> </td> <td> </td> <td> </td> <td> </td> </tr> </tbody> </table>		NO.	DATE	BY	REMARKS					<p>SCALE: N.T.S.</p> <table border="1"> <tr> <td>DSN. BY: BFK</td> <td>DATE: 12/13/06</td> <td>SHEET</td> </tr> <tr> <td>DWN. BY: JJB</td> <td>DATE: 12/13/06</td> <td>76</td> </tr> <tr> <td>CHKD: BFK</td> <td>DATE: 12/13/06</td> <td></td> </tr> <tr> <td>JOB NO. 040630</td> <td>DGN. NAME: MISC01LS2</td> <td>OF 107 SHTS</td> </tr> </table>		DSN. BY: BFK	DATE: 12/13/06	SHEET	DWN. BY: JJB	DATE: 12/13/06	76	CHKD: BFK	DATE: 12/13/06		JOB NO. 040630	DGN. NAME: MISC01LS2	OF 107 SHTS
NO.	DATE	BY	REMARKS																				
DSN. BY: BFK	DATE: 12/13/06	SHEET																					
DWN. BY: JJB	DATE: 12/13/06	76																					
CHKD: BFK	DATE: 12/13/06																						
JOB NO. 040630	DGN. NAME: MISC01LS2	OF 107 SHTS																					