

FOR INDEX OF SHEETS, SEE SHEET NO. 2

DESIGN DESIGNATION - 6350(20) INTERSTATE 659.70 (CRCP-30)
 FAI 80 (INTERSTATE 80)
 ADT: I-80 = 159,100 (1995); 192,000 (2020)
 DESIGN SPEED: I-80 = 110 KM/HR

STATION EQUATION AND/OR BASELINE SHIFT:
 STA 3+245.463, 18.479 m RT @ I-80
 STA 160+000.000 @ RAMP L =
 STA 3+129.453, 22.080 m LT @ I-80 =
 STA 131+106.943 @ RAMP H
 STA 3+531.512, 18.479 m LT @ I-80 =
 STA 180+506.391 @ RAMP N

LENGTH OF PROJECT:
 I-80 = 1532.3 METER
 GROSS LENGTH = 1532.3 METER = 1.532 KILOMETER
 NET LENGTH = 1532.3 METER = 1.532 KILOMETER

STATE OF ILLINOIS
 DEPARTMENT OF TRANSPORTATION
 DIVISION OF HIGHWAYS
**PROPOSED
 HIGHWAY PLANS**

FAI ROUTE 80/94 (I-80/94)
 SECTION (0203.1 & 0304)R-6
 PROJECT: ACNH1-080-5(065)160

EB & WB INSIDE LANES (MAINLINE) EAST OF TOLLWAY OASIS
 TO WEST OF IL 83 (TORRENCE AVENUE)

COOK COUNTY
 C-91-011-01

F.A.I. RTE.	SECTION	COUNTY	TOTAL SHEETS	SHEET
80/94	0203.1 & 0304R-6	COOK	246	1

CONTRACT #62105

D-91-009-01

THIS PROJECT IS LOCATED IN
 THE VILLAGES OF LANSING, SOUTH HOLLAND
 AND THORNTON IN COOK COUNTY.

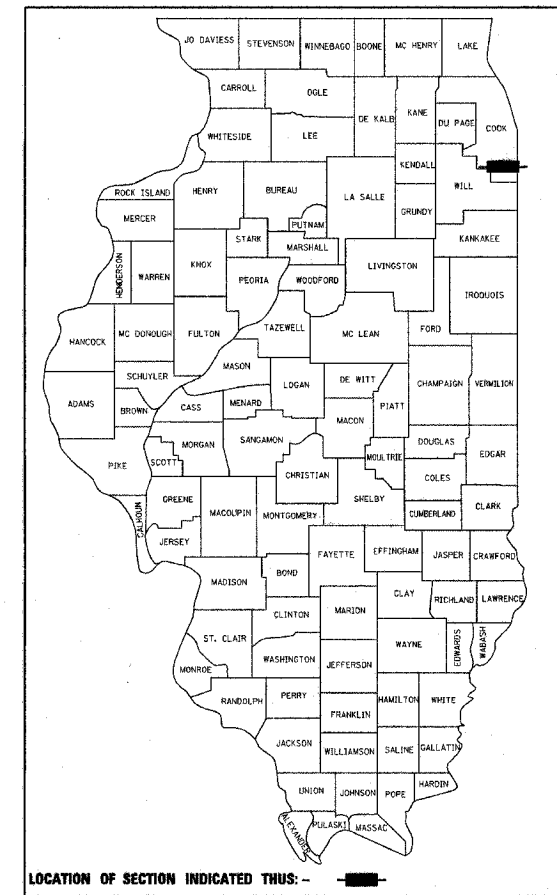

LOCATION OF SECTION INDICATED THIS: -

STATE OF ILLINOIS
 DEPARTMENT OF TRANSPORTATION
 DIVISION OF HIGHWAYS

SUBMITTED July 12, 20 05
Diana O'Keefe
 DEPUTY DIRECTOR OF HIGHWAYS, REGION ENGINEER

October 14, 20 05
Mike Hine
 ENGINEER OF DESIGN AND ENVIRONMENT

October 14, 20 05
Eric E. Harn
 DEPUTY DIRECTOR OF HIGHWAYS, CHIEF ENGINEER

PRINTED BY THE AUTHORITY
 OF THE STATE OF ILLINOIS

McDonough Associates Inc.
 Engineers/Architects

COMPANY:
 MCDONOUGH ASSOCIATES, INC.
 ENGINEERS / ARCHITECTS
 130 EAST RANDOLPH SUITE 1000
 CHICAGO, ILLINOIS 60601

SIGNATURE
 NAME: RICHARD SAMS
 EXP. 11/30/2005

SHEETS: 1-148, 160-231C

SEAL
 RICHARD ALLEN SAMS
 36430
 REGISTERED
 PROFESSIONAL
 ENGINEER
 OF
 ILLINOIS

8-18-05

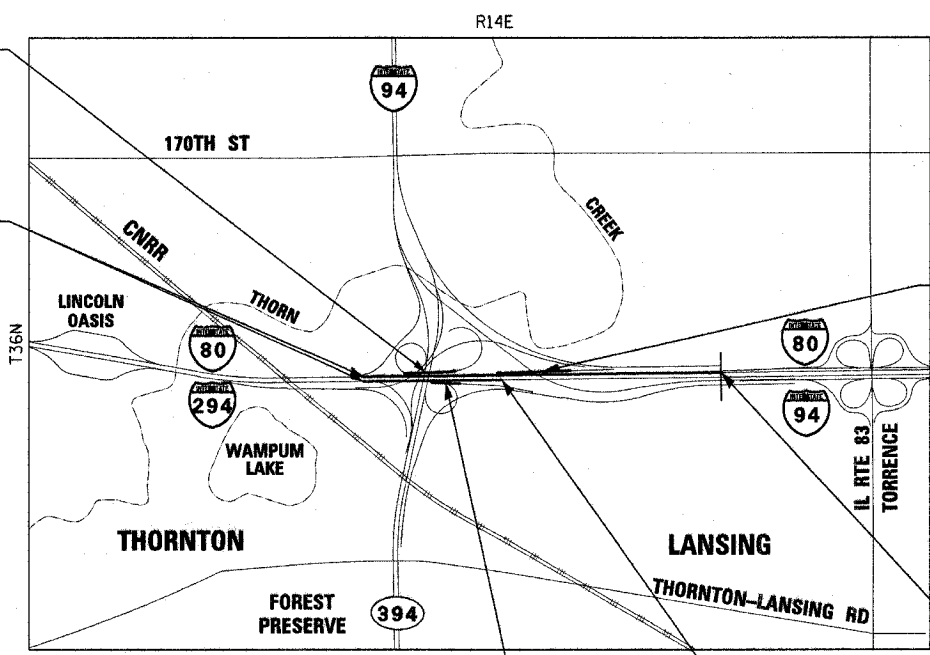

LIMITS OF PROJECT
 STA. 130+750.000 TO
 STA. 131+106.943 @ RAMP H

PROJECT BEGINS
 STA. 2+967.681 (5+00.00)
 @ I-80 EB & WB

LIMITS OF PROJECT
 STA. 180+081.020 TO
 STA. 180+506.391 @ RAMP N

PROJECT ENDS
 STA 4+500.000 @ I-80 WB

PROJECT ENDS
 STA 3+550.000 @ I-80 EB

LIMITS OF PROJECT
 STA. 160+000.000 TO
 STA. 160+325.300 @ RAMP L

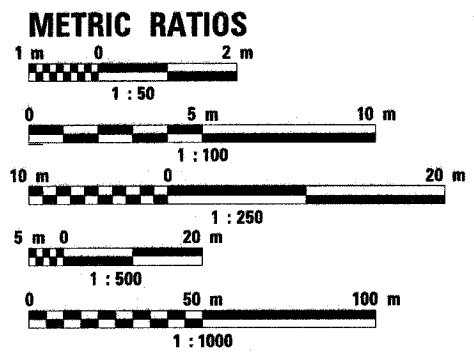

FULL SIZE PLANS HAVE BEEN PREPARED USING STANDARD
 ENGINEERING SCALES. REDUCED SIZED PLANS WILL NOT
 CONFORM TO STANDARD SCALES. IN MAKING MEASUREMENTS
 ON REDUCED PLANS, THE ABOVE SCALES MAY BE USED.

J.U.L.I.E.
 JOINT UTILITY LOCATION INFORMATION FOR EXCAVATION
 1-800-892-0123

CONTRACT NO. 62105

COMPANY:
 MCDONOUGH ASSOCIATES, INC.
 ENGINEERS / ARCHITECTS
 130 EAST RANDOLPH SUITE 1000
 CHICAGO, ILLINOIS 60601

SIGNATURE
 NAME: KAMIL M. YENICE
 EXP. 11/30/2005

SHEETS: 149-155, 156-159

SEAL
 KAMIL M. YENICE
 062-054005
 LICENSED
 PROFESSIONAL
 ENGINEER
 OF
 ILLINOIS

8-18-05

CONSULTANT PROJECT ENGINEER: CATHERINE KIBBLE (847) 705-4269 - SCHAMBERG, ILL.

Contract 18-cv-65013a-ep 8/18/2005 8:59:08 AM

INDEX OF SHEETS

SHEET NO.	DRAWING NO.	DRAWING TITLE
1	CV-1	TITLE SHEET
2	IS-1	INDEX OF SHEETS AND HIGHWAY STANDARDS
3	KM-1	KEY MAP
4	GN-1	GENERAL NOTES AND COMMITMENTS
5	CS-1	SUGGESTED SEQUENCE OF CONSTRUCTION
6-11	SQ-1 TO SQ-6	SUMMARY OF QUANTITIES
12-15	SC-1 TO SC-4	SCHEDULE OF QUANTITIES
16-21	TS-1 TO TS-6	TYPICAL SECTIONS
22	TS-7	PIPE UNDERDRAIN AND SUBGRADE DETAILS FOR OPEN AND CLOSED DRAINAGE SYSTEMS
23-29	TB-1 TO TB-7	ALIGNMENTS, TIES AND BENCHMARKS
30	TM-1	MAINTENANCE OF TRAFFIC KEY MAP
31-33	MT-1 TO MT-3	MAINTENANCE OF TRAFFIC TYPICAL SECTIONS
34	MT-4	MAINTENANCE OF TRAFFIC PRE-STAGE WORK
35-40	MT-5 TO MT-10	MAINTENANCE OF TRAFFIC STAGE 1
41-44	MT-11 TO MT-14	MAINTENANCE OF TRAFFIC STAGE 1A
45-50	MT-15 TO MT-20	MAINTENANCE OF TRAFFIC STAGE 2
51-61	BP-1 TO BP-11	BORING LOCATION PLANS AND SOIL PROFILES
62-75	PF-1 TO PF-14	EXISTING AND PROPOSED ROADWAY PLAN AND PROFILE
76-85	DU-1 TO DU-10	EXISTING AND PROPOSED DRAINAGE PLAN AND PROFILE
86-88	DU-11 TO DU-13	DRAINAGE SCHEDULES
89	IG-1	GRADING PLAN
90-101	SU-1 TO SU-12	SUBSURFACE UTILITY ENGINEERING PLANS
102-111	RW-1 TO RW-10	PLAT OF HIGHWAYS
112-121	PD-1 TO PD-10	PAVEMENT ELEVATIONS AND DETAILS
122-129	PM-1 TO PM-8	FINAL PAVEMENT MARKINGS
130-131	SS-1 TO SS-2	SIGNING STRIP MAP
132-133	SI-1 TO SI-2	SIGN PANEL MOUNTING DETAILS
133A	SI-3	SIGN PANEL MOUNTING DETAILS - HIGHWAY ADVISORY RADIO FLASHING BEACON SIGN DETAILS
133B-133C	SI-4 TO SI-5	BREAK-AWAY WIDE FLANGE STEEL SIGN POST TABLES
134	ED-1	EROSION AND SEDIMENT CONTROL GENERAL NOTES AND LEGEND
135	ED-2	EROSION AND SEDIMENT CONTROL GENERAL NOTES AND STRATEGY
136-141	EC-1 TO EC-6	EROSION AND SEDIMENT CONTROL PLAN
142-147	ED-1 TO ED-6	EROSION AND SEDIMENT CONTROLS DETAILS
148	ED-7	TRAFFIC CONTROL FOR STABILIZED CONSTRUCTION ENTRANCE/EXIT
149-150	GE-1 TO GE-2	ELECTRICAL SYMBOLS, ABBREVIATIONS AND GENERAL NOTES
151-155	RL-1 TO RL-5	ELECTRICAL RACEWAY PLANS
155A-155E	FO16-1 TO FO16-5	ELECTRICAL RACEWAY PLANS
155F	MD22-10	TYPICAL SINGLE MAGNETO-INDUCTIVE VEHICLE SENSOR (FULL INSTALLATION/SPEED TRAP)
156-159	ED-1 TO ED-4	ELECTRICAL DETAILS
160	MD-1	SLEEPER SLAB DETAIL AND MISCELLANEOUS JOINT DETAILS (FOR INFORMATION ONLY)
161	MD-2	EMERGENCY TURNAROUND AND TEMPORARY CONCRETE BARRIER DETAILS
162	MD-3	PCC STABILIZATION AT STEEL PLATE BEAM GUARDRAIL / CONCRETE GUTTER, TYPE A (MODIFIED)
163-164	MD-4 TO MD-5	CONCRETE BARRIER DETAILS
165	MD-6	CONCRETE GLARE SCREEN, SPECIAL
166	MD-7	CONCRETE BARRIER DETAILS, 815 MM WALL
167	MD-8	CONCRETE BARRIER DETAILS, 1065 MM WALL
168	MD-9	LONG TERM TRANSVERSE CONSTRUCTION JOINT DETAILS
169	MD-10	DETAILS FOR PLACEMENT OF PAVEMENT MARKING AND SHOULDER RUMBLE STRIPS ON 4.2M PAVEMENT
170	MD-11	MILE MARKER SIGN AND POST DETAILS
171-172		<i>C&C PAVEMENT</i>
173-174		<i>DETAILS</i>
174A	MD-16	PCC SHOULDER DETAILS
175	LI-1	HIGH MAST LIGHT TOWER FOUNDATION AT MEDIAN BARRIER DETAIL (FOR INFORMATION ONLY)
176	LI-2	HIGH MAST FOUNDATION SERVICE PAD & WALL DETAILS (FOR INFORMATION ONLY)
177-180	DD-1 TO DD-4	DRAINAGE DETAILS
180A-180B	DD-5 TO DD-6	DRAINAGE DETAILS
181	DS-1	BD-49 DETAIL FOR CENTERLINE SAWCUT 4.9 M AND VARIABLE JOINTED PCC PAVEMENT FOR RAMPS
182	DS-2	BD-51 BENCHING DETAIL FOR EMBANKMENT WIDENING
183	DS-3	CS-8 (METRIC) CATCH BASIN AND INLET 1.2m x 0.9m AND 1.2m x 1.5m FOR H > 2.4
184	DS-4	CS-10A (METRIC) DRAINAGE STRUCTURES CATCH BASINS 2.4m x 0.9m AND 2.4m x 1.5m FOR DEPTHS WHERE H < 2.5
185	DS-5	CS-10B (METRIC) DRAINAGE STRUCTURES CATCH BASINS 2.4m x 0.9m AND 2.4m x 1.5m FOR DEPTHS WHERE H < 2.5
186	DS-6	TC-8 FREEWAY ENTRANCE AND EXIT RAMP CLOSURE DETAILS
187	DS-7	TC-9 TRAFFIC CONTROL DETAILS FOR FREEWAY SINGLE AND MULTI-LANE WEAVE
188-189	DS-8 TO DS-9	TC-12 MULTILANE FREEWAY PAVEMENT MARKING DETAILS
190	DS-10	TC-17 TRAFFIC CONTROL DETAILS FOR FREEWAY SHOULDER CLOSURES PARTIAL RAMP CLOSURES
191	DS-11	TC-18 SIGNING FOR FLAGGING OPERATIONS AT WORK ZONE OPENINGS
192	XS-1	CROSS SECTION KEY MAP
193-231	XS-2 TO XS-40	CROSS SECTIONS
231A-231C	XS-41 TO XS-43	CROSS SECTIONS

F.A.I. RTE.	SECTION	COUNTY	TOTAL SHEETS	SHEET NO.
80/94	*	COOK	231	2
STA.	TO STA.			
FED. ROAD DIST. NO. 1	ILLINOIS	FED. AID PROJECT		
*(0203.1 & 0304) R-6			CONTRACT # 62105	

LIST OF ILLINOIS DOT HIGHWAY STANDARDS

000001-04	STANDARD SYMBOLS, ABBREVIATIONS, AND PATTERNS
001001	AREAS OF REINFORCEMENT BARS
280001-02	TEMPORARY EROSION CONTROL SYSTEMS
420001-06	PAVEMENT JOINTS
420206-05	ENTRANCE RAMP TERMINAL (JOINTED PCC RAMP PAVEMENT ADJACENT TO CRC MAINLINE PAVEMENT)
420306-05	EXIT RAMP TERMINAL (JOINTED PCC RAMP PAVEMENT ADJACENT TO CRC MAINLINE PAVEMENT)
421001-01	BAR REINFORCEMENT FOR CRC PAVEMENT
542101	REINFORCED CONCRETE END SECTIONS FOR PIPE CULVERTS 375 MM (15") THRU 900 MM (36") DIAMETER AT RIGHT ANGLE WITH ROADWAY
542601	REINFORCED CONCRETE PIPE ELBOW
601001	SUB-SURFACE DRAINS
601101	CONCRETE HEADWALL FOR PIPE DRAINS
602001	CATCH BASIN, TYPE A
602101-01	DRAINAGE STRUCTURES, TYPES 1, 2 & 3
602106	DRAINAGE STRUCTURES, TYPES 4, 5 & 6
602301	INLET, TYPE A
602401	MANHOLE, TYPE A
602601	PRECAST REINFORCED CONCRETE FLAT SLAB TOP
602701	CAST IRON STEPS
604036-01	GRATE, TYPE B
604071-02	FRAME AND GRATE, TYPE 20
604081-02	FRAMES AND GRATES, TYPE 22
606101-01	TYPE A GUTTER (INLET, OUTLET, AND ENTRANCE)
630001-05	STEEL PLATE BEAM GUARDRAIL
630201-03	PCC/BITUMINOUS STABILIZATION AT STEEL PLATE BEAM GUARDRAIL
630301-03	SHOULDER WIDENING FOR TYPE I (SPECIAL) GUARDRAIL TERMINALS
631011-02	TRAFFIC BARRIER TERMINAL, TYPE 2
635001	DELINEATORS
635006-02	REFLECTOR AND TERMINAL MARKER PLACEMENT
635011-01	REFLECTOR MARKER AND MOUNTING DETAILS
642001	SHOULDER RUMBLE STRIPS
664001-01	CHAIN LINK FENCE
701101-01	OFF-ROAD OPERATIONS, MULTILANE, LESS THAN 4.5 M (15') TO 600 MM (24") FROM PAVEMENT EDGE
701106-01	OFF-ROAD OPERATIONS, MULTILANE, MORE THAN 4.5 M (15') AWAY
701400-02	APPROACH TO LANE CLOSURE, FREEWAY/EXPRESSWAY
701401-03	LANE CLOSURE, FREEWAY/EXPRESSWAY
701402-05	LANE CLOSURE, FREEWAY/EXPRESSWAY, WITH BARRIER
701411-03	LANE CLOSURE, MULTILANE, AT ENTRANCE OR EXIT RAMP, FOR SPEEDS ≥ 45 MPH
701426-02	LANE CLOSURE MULTILANE, INTERMITTENT OR MOVING OPERATIONS, FOR SPEEDS ≥ 45 MPH
701446	TWO LANE CLOSURE, FREEWAY/EXPRESSWAY
702001-05	TRAFFIC CONTROL DEVICES
704001-02	TEMPORARY CONCRETE BARRIER
720001	SIGN PANEL MOUNTING DETAILS
720006	SIGN PANEL ERECTION DETAILS
720011	METAL POSTS FOR SIGNS, MARKERS AND DELINEATORS
720021-01	SIGN PANELS, EXTRUDED ALUMINUM TYPE
729001	APPLICATIONS OF TYPES A AND B METAL POSTS (FOR SIGNS & MARKERS)

IS-1

REVISIONS		ILLINOIS DEPARTMENT OF TRANSPORTATION F.A.I. ROUTE 80/94 (INTERSTATE 80/294)
NAME	DATE	
		INDEX OF SHEETS AND HIGHWAY STANDARDS
DATE: JULY 18, 2005		DRAWN BY: JPW CHECKED BY: RCH
 McDonough Associates Inc. Engineers / Architects		

F.A.I. RTE.	SECTION	COUNTY	TOTAL SHEETS	SHEET NO.
80/94	*	COOK	231	3
STA.		TO STA.		
FED. ROAD DIST. NO. 1		ILLINOIS	FED. AID PROJECT	
*(0203.1 & 0304) R-6		CONTRACT # 62105		

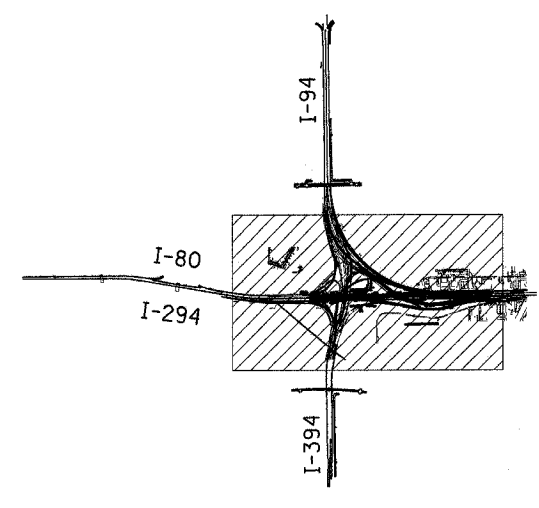

IL. RT. 83

I-80
I-94

WENTWORTH AV.

PROJECT LOCATION MAP

SCALE - 1:30000

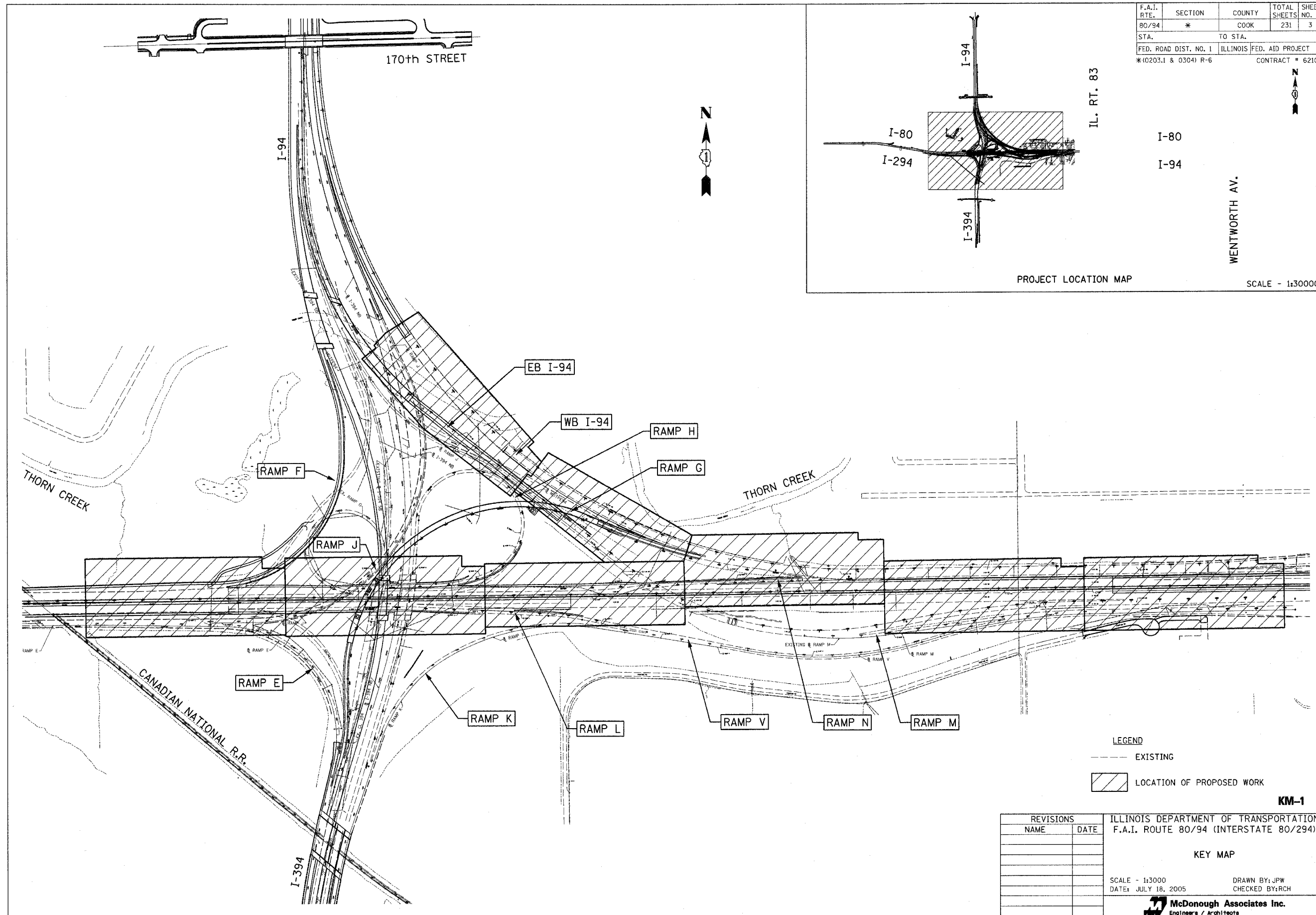

LEGEND

- EXISTING
- ▨ LOCATION OF PROPOSED WORK

KM-1

REVISIONS	
NAME	DATE

ILLINOIS DEPARTMENT OF TRANSPORTATION
F.A.I. ROUTE 80/94 (INTERSTATE 80/294)

KEY MAP

SCALE - 1:3000
DATE: JULY 18, 2005
DRAWN BY: JPW
CHECKED BY: RCH

McDonough Associates Inc.
Engineers / Architects

F.A.I. RTE.	SECTION	COUNTY	TOTAL SHEETS	SHEET NO.
80/94	*	COOK	231	4
STA.		TO STA.		
FED. ROAD DIST. NO. 1		ILLINOIS	FED. AID PROJECT	
*(0203.1 & 0304) R-6		CONTRACT # 62105		

GENERAL NOTES

- BEFORE STARTING ANY EXCAVATION, THE CONTRACTOR SHALL CALL J.U.L.I.E. (1-800-892-0123) FOR FIELD LOCATIONS OF BURIED ELECTRIC, TELEPHONE AND GAS FACILITIES. (48 HOURS NOTIFICATION IS REQUIRED).
- THE CONTRACTOR SHALL COORDINATE CONSTRUCTION ACTIVITIES WITH UTILITY COMPANIES, MUNICIPALITIES AND ADJACENT CONTRACTORS.
- THE CONTRACTOR WILL NOT BE ALLOWED TO SET UP A YARD OR FIELD OFFICE ON STATE PROPERTY WITHOUT WRITTEN PERMISSION FROM THE DEPARTMENT.
- THE REMOVAL OF GUARDRAIL TERMINAL SECTIONS SHALL BE MEASURED AND PAID FOR AT UNIT PRICE PER METER FOR STEEL PLATE BEAM GUARDRAIL REMOVAL.
- BARRICADES:** THE CONTRACTOR SHALL PROVIDE AND INSTALL TWO (2) WEIGHTED SAND BAGS ON EACH TYPE I OR TYPE II BARRICADE USED-ONE (1) WEIGHTED SAND BAG ACROSS EACH BOTTOM RAIL.
- WHEN ARTIFICIAL LIGHTING IS UTILIZED IN NIGHT OPERATIONS, THE CONTRACTOR SHALL EXERCISE THE UTMOST PRECAUTIONS IN PREVENTING ADVERSE VISIBILITY TO THE MOTORING PUBLIC AND ADJOINING RESIDENTIAL AREAS.
- SAWCUTTING WILL NOT BE PAID FOR SEPARATELY BUT SHALL BE CONSIDERED INCLUDED IN THE COST OF THE ITEM BEING REMOVED, UNLESS OTHERWISE SPECIFIED.
- POROUS GRANULAR EMBANKMENT, SUBGRADE (PGES) MAY BE USED AT LOCATIONS WHERE UNSUITABLE OR UNSTABLE MATERIAL IS ENCOUNTERED DURING CONSTRUCTION. SOILS WILL BE TESTED BY THE ENGINEER IN ACCORDANCE WITH ARTICLE 301.03 AND THE UNDERCUT GUIDELINES IN THE IDOT SUBGRADE STABILITY MANUAL. THE ACTUAL LIMITS AND DEPTHS OF REMOVAL AND REPLACEMENT WILL BE DETERMINED BY THE ENGINEER. THE ENGINEER WILL DETERMINE IF THE REMOVED MATERIAL IS UNSUITABLE OR UNSTABLE BASED ON THE FOLLOWING CRITERIA. UNSUITABLE MATERIAL IS THAT WHICH, WITH ADEQUATE PROCESSING, CAN MEET THE REQUIREMENTS OF EMBANKMENT AS OUTLINED IN THIS CONTRACT. UNSUITABLE MATERIAL DOES NOT MEET THE REQUIREMENTS FOR EMBANKMENT MATERIALS. UNSUITABLE SOILS SHALL BE REMOVED AND DISPOSED OF BY THE CONTRACTOR IN ACCORDANCE WITH SECTION 202 OF THE STANDARD SPECIFICATIONS FOR ROAD AND BRIDGE CONSTRUCTION. UNSUITABLE MATERIALS WILL BE MEASURED FOR PAYMENT AS EARTH EXCAVATION AND MAY BE PROCESSED AND USED IN THE EMBANKMENT OR DISPOSED OF, IN ACCORDANCE WITH ARTICLE 202.03.
- ANY REFERENCE TO "STANDARD" THROUGHOUT THE PLANS OR SPECIAL PROVISIONS SHALL BE CONSIDERED TO BE THE "STANDARD SPECIFICATIONS FOR ROAD AND BRIDGE CONSTRUCTION" ADOPTED JANUARY 1, 2002 BY THE STATE OF ILLINOIS DEPARTMENT OF TRANSPORTATION, AND "SUPPLEMENTAL SPECIFICATIONS AND RECURRING SPECIAL PROVISIONS" DATED MARCH 1, 2005.
- THE CONTRACTOR SHALL VERIFY THE DIMENSIONS OF THE CONCRETE BARRIER WALL AND BRIDGE PARAPETS WITH THE ENGINEER PRIOR TO FABRICATING THE BARRIER WALL AND PARAPET FORMS.
- THE PHASE III CONSULTANT WILL BE RESPONSIBLE FOR THE RE-ESTABLISHMENT OF CONTROL AND TIE POINTS AS SHOWN ON THE ALIGNMENT AND TIES SHEETS. THE CONTRACTOR SHALL COORDINATE THE RE-ESTABLISHMENT OF THE EXISTING CONTROL AND TIE POINTS DISTURBED BY THE CONSTRUCTION ACTIVITIES WITH THE RESIDENT ENGINEER AND PHASE III CONSULTANT. EXISTING CONTROL AND TIE POINT LOCATIONS THAT ARE CONSIDERED NOT VIABLE UNDER THE FINAL CONDITIONS MAY BE RE-ESTABLISHED AT A MORE FEASIBLE LOCATION, AS APPROVED BY THE RESIDENT ENGINEER. THE PHASE III CONSULTANT SHALL SUBMIT DOCUMENTATION OF ALL RE-ESTABLISHED CONTROL AND TIE POINTS TO THE DEPARTMENT NO LATER THAN ONE (1) MONTH AFTER COMPLETION OF THE CONTRACT.
- THE CONTRACTOR SHALL SCHEDULE A PERIOD OF TIME (MINIMUM OF 5 WORKING DAYS) BETWEEN THE PLACEMENT OF THE SUB-BASE GRANULAR MATERIAL AND THE STABILIZED SUB-BASE 150MM TO ALLOW THE HIGHWAY LIGHTING AND SURVEILLANCE CONTRACTOR TIME TO INSTALL THE VEHICLE DETECTION SYSTEM.
- PAVEMENT MARKING REMOVAL:** THIS WORK SHALL BE PERFORMED IN ACCORDANCE WITH SECTION 783 OF THE STANDARD SPECIFICATIONS EXCEPT THAT ARTICLE 783.02 (B) GRINDERS WILL NOT BE ALLOWED. ARTICLE 783.03 IS REVISED TO INCLUDE ITEM 783.02 (C) WATER JETTING (NOTE 1).

COMMITMENTS

- PRIOR TO CONSTRUCTION COMMENCING IN THE INTERSTATE 94/ILLINOIS ROUTE 394 INTERCHANGE AREA, THE LOCATION OF THE ORCHID WILL BE IDENTIFIED AND FENCING WILL BE ERRECTED AROUND THE AREA TO PREVENT THE INTRUSION OF PERSONNEL AND VEHICLES. ALSO, A TRAINING SESSION WILL BE HELD AT THE PRE-CONSTRUCTION MEETING TO ALERT CONSTRUCTION PERSONNEL OF THE SENSITIVITY OF THE PLANT SPECIES AND THE NEED TO AVOID ACCIDENTAL INTRUSIONS OR SPILLS IN THE AREA. THE TRAINING SESSION WILL ALSO ADDRESS AVOIDING ACCIDENTAL INTRUSIONS INTO THE NOTEWORTHY BOTANICAL AREAS THAT WILL NOT BE IMPACTED. THIS INCLUDES THE VOLBRECHT WOODS, WAMPUM LAKE SEEPAGE INAI SITES, AND THE IDENTIFIED SAND FLATWOOD COMMUNITIES.
- BASED ON THE SENSITIVITY OF THE PLANT COMMUNITIES IN THE SOUTHWEST QUADRANT OF THE INTERSTATE 94/ILLINOIS ROUTE 394 INTERCHANGE, PRECAUTIONS WILL BE TAKEN TO MAINTAIN EXISTING GROUNDWATER LEVELS THAT ARE SUPPORTING THIS COMMUNITY. RUBBER GASKET SEALED STORM SEWERS WILL BE PROVIDED IN AREAS WHERE PROPOSED STORM SEWERS INTERCEPT THE GROUNDWATER LEVEL WITHIN THE FPDC AND INTERCHANGE AREA. IN ADDITION, ANTI-SEEP COLLARS WILL BE PLACED ON STORM SEWERS IN THIS AREA.
- THE NEAR SURFACE GROUNDWATER UPON WHICH THE BIOLOGICALLY SENSITIVE AREAS DEPEND WILL BE PROTECTED FROM COMPACTION DURING CONSTRUCTION AND DRAINAGE DURING ANY AND ALL EXCAVATIONS BELOW GROUNDWATER. IN ORDER TO MAINTAIN EXISTING SOIL PERMEABILITY IN THE SOUTHWEST AND SOUTHEAST QUADRANTS, THE USE OF SPECIAL PRACTICES WILL MINIMIZE SOIL COMPACTION THROUGH THE WORK ZONE. THIS WILL INCLUDE THE USE OF LOW GROUND WEIGHT VEHICLES OR MATTING TO REDUCE RUTTING. THE CONTRACTOR IS RESPONSIBLE FOR RESTORATION OF ALL RUTTED OR COMPACTED AREAS TO THE SATISFACTION OF THE ENGINEER.
- THE CONSTRUCTION OF ROADSIDE DRAINAGE SWALES WILL NOT INTERCEPT GROUNDWATER LEVELS. ROADSIDE SWALES ARE CONSTRUCTED WITHIN THE INTERCHANGE AREAS TO ACCEPT ROADWAY DRAINAGE ONLY. TOPSOIL IN THE PERMANENT CONSTRUCTION ZONES WILL BE SEGREGATED FOR POTENTIAL RE-USE WITHIN THE TEMPORARY WORK AREAS AFTER CONSTRUCTION IS COMPLETE. THE CONTRACTOR'S STOCKPILE LOCATIONS SHALL BE APPROVED BY THE ENGINEER.
- IN ADDITION TO THE EROSION AND SEDIMENT CONTROL FENCING AROUND THE CONSTRUCTION LIMITS, IDOT WILL PROVIDE CHAIN LINK FENCING AROUND WETLANDS AND WATER BODIES TO PREVENT ACCIDENTAL INTRUSIONS OF THE CONSTRUCTION PERSONNEL AND EQUIPMENT. NON-INTRUSION ZONE SIGNING WILL ALSO BE INSTALLED WITH THE FENCING.

GN-1

REVISIONS		ILLINOIS DEPARTMENT OF TRANSPORTATION F.A.I. ROUTE 80/94 (INTERSTATE 80/294)
NAME	DATE	
		GENERAL NOTES AND COMMITMENTS
		DATE: JULY 18, 2005
		DRAWN BY: JPW CHECKED BY: RCH
		 McDonough Associates Inc. Engineers / Architects

Rev.

F.A.I. RTE. 80/94	SECTION *	COUNTY COOK	TOTAL SHEETS 231	SHEET NO. 5
STA.		TO STA.		
FED. ROAD DIST. NO. 1		ILLINOIS	FED. AID PROJECT	
*(0203.1 & 0304) R-6		CONTRACT # 62105		

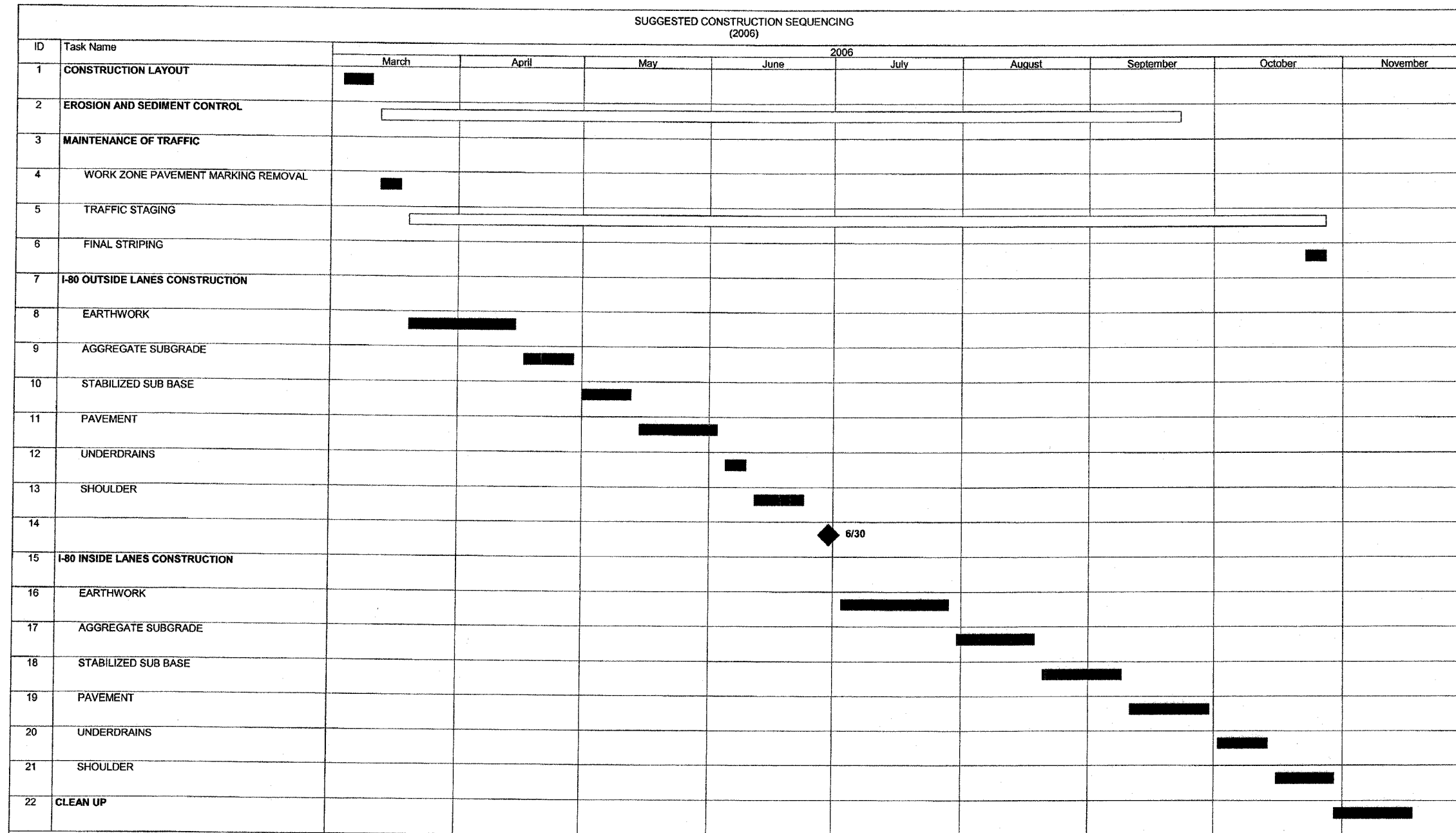

START PROJECT: MARCH 04, 2006
 COMPLETE PROJECT: OCTOBER 29, 2006
 COMPLETE CLEAN UP: NOVEMBER 17, 2006

LEGEND

- CONTROLLING ITEM
- NON-CONTROLLING ITEM
- INTERIM COMPLETION DATE

REVISIONS	
NAME	DATE

CS-1

ILLINOIS DEPARTMENT OF TRANSPORTATION
 F.A.I. ROUTE 80/94 (INTERSTATE 80/294)

SEQUENCE OF CONSTRUCTION

DATE: JULY 18, 2005
 DRAWN BY: TRK
 CHECKED BY: RCH

McDonough Associates Inc.
 Engineers / Architects

F.A.I. RTE.	SECTION	COUNTY	TOTAL SHEETS	SHEET NO.
80/94	*	COOK	231	6
STA.	TO STA.			
FED. ROAD DIST. NO. 1	ILLINOIS	FED. AID PROJECT		
*(0203.1 & 0304) R-6			CONTRACT # 62105	

CODE NO.	PAY ITEM	UNIT	TOTAL QUANTITY	ROADWAY	SIGNING	ELECTRICAL
				CONSTRUCTION TYPE CODE		
				J000-2A	Y002-1C	Y030-1E
M2020010	EARTH EXCAVATION	CU M	35,725	35,725		
M2020045	EARTH EXCAVATION (SPECIAL)	CU M	175	175		
M2021200	REMOVAL AND DISPOSAL OF UNSUITABLE MATERIAL	CU M	2,020	2,020		
M2080150	TRENCH BACKFILL	CU M	675	675		
M2090410	SAND BACKFILL	CU M	103	103		
M2101000	GEOTECHNICAL FABRIC FOR GROUND STABILIZATION	SQ M	52,350.0	52,350.0		
M2113150	TOPSOIL FURNISH AND PLACE, 150MM	SQ M	22,723	22,723		
M2500210	SEEDING, CLASS 2A	HA	2.0	2.0		
M2500310	SEEDING, CLASS 4	HA	1.0	1.0		
M2500400	NITROGEN FERTILIZER NUTRIENT	KG	200	200		
M2500500	PHOSPHORUS FERTILIZER NUTRIENT	KG	200	200		
M2500600	POTASSIUM FERTILIZER NUTRIENT	KG	200	200		
M2510115	MULCH, METHOD 2	HA	3.0	3.0		
M2510630	EROSION CONTROL BLANKET	SQ M	1,203	1,203		
M2520200	SUPPLEMENTAL WATERING	UNIT	4,545	4,545		
28000300	TEMPORARY DITCH CHECKS	EACH	4	4		
28000500	INLET AND PIPE PROTECTION	EACH	6	6		
28000510	INLET FILTERS	EACH	110	110		
M2810107	STONE RIPRAP, CLASS A4	SQ M	68	68		
M2820000	FILTER FABRIC	SQ M	68	68		
M3111300	SUB-BASE GRANULAR MATERIAL, TYPE B 300MM	SQ M	50,971.3	50,971.3		
M3120100	STABILIZED SUB-BASE 100MM	SQ M	1,378	1,378		
M3120150	STABILIZED SUB-BASE 150MM	SQ M	50,971	50,971		
M4060895	CONSTRUCTING TEST STRIP	EACH	1	1		
42001700	FURNISH PROFILOGRAPH	L SUM	1	1		
M4202285	PORTLAND CEMENT CONCRETE PAVEMENT 280MM (JOINTED)	SQ M	495	495		
M4205200	PROTECTIVE COAT	SQ M	6,450	6,450		
M4210360	CONTINUOUSLY REINFORCED PORTLAND CEMENT CONCRETE PAVEMENT 360MM	SQ M	34,286	34,286		
M4214360	PAVEMENT REINFORCEMENT 360MM	SQ M	34,286	34,286		

URBAN
90% FED.
10% STATE

SQ-1

REVISIONS		ILLINOIS DEPARTMENT OF TRANSPORTATION F.A.I. ROUTE 80/94 (INTERSTATE 80/294)
NAME	DATE	
		<p align="center">SUMMARY OF QUANTITIES</p> <p align="right">DRAWN BY: AAS CHECKED BY: RCH</p> <p align="right">DATE: JULY 18, 2005</p> <p align="center"> McDonough Associates Inc. Engineers / Architects</p>

F.A.I. RTE.	SECTION	COUNTY	TOTAL SHEETS	SHEET NO.
80/94	*	COOK	231	7
STA.	TO STA.			
FED. ROAD DIST. NO. 1		ILLINOIS FED. AID PROJECT		
*(0203.1 & 0304) R-6		CONTRACT # 62105		

CODE NO.	PAY ITEM	UNIT	TOTAL QUANTITY	ROADWAY	SIGNING	ELECTRICAL
				CONSTRUCTION TYPE CODE	WORK	WORK
				J000-2A	Y002-1C	Y030-1E
M4218000	PROTECTIVE COAT	SQ M	34,286	34,286		
M4402000	PAVEMENT REMOVAL	SQ M	32,142	32,142		
M4402030	GUTTER REMOVAL	METER	9	9		
M4402280	CONCRETE BARRIER REMOVAL	METER	230	230		
M4402530	PAVED SHOULDER REMOVAL	SQ M	11,005	11,005		
M4812280	AGGREGATE SHOULDERS, TYPE B 280MM	SQ M	114	114		
M4812360	AGGREGATE SHOULDERS, TYPE B 360MM	SQ M	303	303		
M4830150	PORTLAND CEMENT CONCRETE SHOULDERS - 150MM	SQ M	215	215		
M4830280	PORTLAND CEMENT CONCRETE SHOULDERS - 280MM	SQ M	700	700		
M4830360	PORTLAND CEMENT CONCRETE SHOULDERS - 360MM	SQ M	14,136	14,136		
M4832000	PROTECTIVE COAT	SQ M	15,051	15,051		
50105200	REMOVE EXISTING CULVERTS	EACH	1	1		
M5423410	PIPE CULVERT, TYPE 2 RCCP 375MM	METER	35	35		
M542B116	REINFORCED CONCRETE PIPE ELBOW 375MM	EACH	4	4		
M542B120	REINFORCED CONCRETE PIPE ELBOW 450MM	EACH	4	4		
M5503050	STORM SEWERS, TYPE 2, REINFORCED CONCRETE CULVERT, STORM DRAIN, AND SEWER PIPE, CLASS III, 300MM	METER	344.5	344.5		
M5503060	STORM SEWERS, TYPE 2, REINFORCED CONCRETE CULVERT, STORM DRAIN, AND SEWER PIPE, CLASS III, 375MM	METER	172.0	172.0		
M5503070	STORM SEWERS, TYPE 2, REINFORCED CONCRETE CULVERT, STORM DRAIN, AND SEWER PIPE, CLASS III, 450MM	METER	196.0	196.0		
M5503090	STORM SEWERS, TYPE 2, REINFORCED CONCRETE CULVERT, STORM DRAIN, AND SEWER PIPE, CLASS III, 600MM	METER	22.0	22.0		
M5503111	STORM SEWERS, TYPE 2, REINFORCED CONCRETE CULVERT, STORM DRAIN, AND SEWER PIPE, CLASS III, 750MM	METER	100.0	100.0		
M5510025	STORM SEWER REMOVAL 300MM	METER	226	226		
60100060	CONCRETE HEADWALL FOR PIPE DRAINS	EACH	3	3		
M6010610	PIPE UNDERDRAINS 150MM	METER	2878.0	2878.0		
M6020170	CATCH BASINS, TYPE A, 1.2M DIAMETER, TYPE 20 FRAME AND GRATE	EACH	11	11		
M6020440	CATCH BASINS, TYPE A, 1.5M DIAMETER, TYPE 8 GRATE	EACH	2	2		
M6020470	CATCH BASINS, TYPE A, 1.5M DIAMETER, TYPE 20 FRAME AND GRATE	EACH	2	2		
60300105	FRAMES AND GRATES TO BE ADJUSTED	EACH	36	36		

SQ-2

REVISIONS		ILLINOIS DEPARTMENT OF TRANSPORTATION F.A.I. ROUTE 80/94 (INTERSTATE 80/294)
NAME	DATE	
SUMMARY OF QUANTITIES		DRAWN BY: AAS CHECKED BY: RCH
DATE: JULY 18, 2005		
 McDonough Associates Inc. Engineers / Architects		

F.A.I. RTE.	SECTION	COUNTY	TOTAL SHEETS	SHEET NO.
80/94	*	COOK	231	8
STA.		TO STA.		
FED. ROAD DIST. NO. 1		ILLINOIS	FED. AID PROJECT	
*(0203.1 & 0304) R-6			CONTRACT # 62105	

CODE NO.	PAY ITEM	UNIT	TOTAL QUANTITY	ROADWAY	SIGNING	ELECTRICAL
				CONSTRUCTION TYPE CODE		
				J000-2A	Y002-1C	Y030-1E
60500040	REMOVING MANHOLES	EACH	4	4		
60500050	REMOVING CATCH BASINS	EACH	4	4		
60500060	REMOVING INLETS	EACH	2	2		
60500105	FILLING MANHOLES	EACH	1	1		
60500705	CATCH BASINS TO BE FILLED TO MAINTAIN FLOW	EACH	3	3		
M6060010	CLASS SI CONCRETE (OUTLET)	CU M	6.9	6.9		
M6060270	CONCRETE GUTTER, TYPE A (MODIFIED)	METER	449.9	449.9		
M6063620	CONCRETE MEDIAN SURFACE, 150MM	SQ M	81	81		
* M6300100	STEEL PLATE BEAM GUARD RAIL, TYPE A	METER	209.55	209.55		
* 63100045	TRAFFIC BARRIER TERMINAL, TYPE 2	EACH	1	1		
* 63100167	TRAFFIC BARRIER TERMINAL TYPE 1, SPECIAL (TANGENT)	EACH	1	1		
M6320030	GUARDRAIL REMOVAL	METER	384.81	384.81		
63500105	DELINEATORS	EACH	81	81		
M6370175	CONCRETE BARRIER, SINGLE FACE, 1065 MM HEIGHT	METER	228	228		
M6370255	CONCRETE BARRIER, DOUBLE FACE, 815MM HEIGHT	METER	390	390		
M6370275	CONCRETE BARRIER, DOUBLE FACE, 1065MM HEIGHT	METER	1,329	1,329		
M6370805	CONCRETE BARRIER TRANSITION	METER	33	33		
M6370805	CONCRETE BARRIER BASE	METER	2,081	2,081		
M6420015	SHOULDER RUMBLE STRIP	METER	9,509	9,509		
67100100	MOBILIZATION	L SUM	1	1		
M7030240	TEMPORARY PAVEMENT MARKING - LINE 150MM	METER	1,953	1,953		
M7030520	PAVEMENT MARKING TAPE, TYPE III 100MM	METER	8359	8359		
M7030530	PAVEMENT MARKING TAPE, TYPE III 125MM	METER	783	783		
M7030550	PAVEMENT MARKING TAPE, TYPE III 200MM	METER	1,053	1,053		
M7030560	PAVEMENT MARKING TAPE, TYPE III 300MM	METER	341	341		
M7031000	WORK ZONE PAVEMENT MARKING REMOVAL	SQ M	1,332	1,332		
M7040100	TEMPORARY CONCRETE BARRIER	METER	977	977		
M7040210	RELOCATE TEMPORARY CONCRETE BARRIER (SPECIAL)	METER	3,486	3,486		

* SPECIALTY ITEMS

SQ-3

REVISIONS		ILLINOIS DEPARTMENT OF TRANSPORTATION F.A.I. ROUTE 80/94 (INTERSTATE 80/294)
NAME	DATE	
		<p>SUMMARY OF QUANTITIES</p> <p>DATE: JULY 18, 2005</p> <p>DRAWN BY: AAS CHECKED BY: RCH</p> <p>McDonough Associates Inc. Engineers / Architects</p>

F.A.I. RTE.	SECTION	COUNTY	TOTAL SHEETS	SHEET NO.
80/94	*	COOK	231	9
STA.		TO STA.		
FED. ROAD DIST. NO. 1		ILLINOIS FED. AID PROJECT		
*(0203.1 & 0304) R-6		CONTRACT # 62105		

CODE NO.	PAY ITEM	UNIT	TOTAL QUANTITY	URBAN 90% FED. 10% STATE	ROADWAY	SIGNING	ELECTRICAL
					CONSTRUCTION TYPE CODE	WORK	
					J000-2A	Y002-1C	Y030-1E
* M7200100	SIGN PANEL - TYPE 1	SQ M	11			11	
* M7200200	SIGN PANEL - TYPE 2	SQ M	13			13	
* M7200300	SIGN PANEL - TYPE 3	SQ M	48			48	
* M7240330	REMOVE SIGN PANEL - TYPE 3	SQ M	106			106	
* M7240730	RELOCATE SIGN PANEL - TYPE 3	SQ M	40			40	
*Δ M7270100	STRUCTURAL STEEL SIGN SUPPORT - BREAKAWAY	KG	321			321	
* M7300100	WOOD SIGN SUPPORT	METER	70			70	
* M7340100	CONCRETE FOUNDATIONS	CU M	1.17			1.17	
* 73700100	REMOVE GROUND-MOUNTED SIGN SUPPORT	EACH	9			9	
* 73700200	REMOVE CONCRETE FOUNDATION - GROUND MOUNT	EACH	9			9	
* M7800605	EPOXY PAVEMENT MARKING - LINE 100MM	METER	4,140		4,140		
* M7800610	EPOXY PAVEMENT MARKING - LINE 125MM	METER	576		576		
* M7800620	EPOXY PAVEMENT MARKING - LINE 200MM	METER	159		159		
* M7800625	EPOXY PAVEMENT MARKING - LINE 300MM	METER	44		44		
* M7802010	POLYUREA PAVEMENT MARKING TYPE I - LINE 100MM	METER	6,706		6,706		
* M7802020	POLYUREA PAVEMENT MARKING TYPE I - LINE 200MM	METER	3,024		3,024		
* M7802030	POLYUREA PAVEMENT MARKING TYPE I - LINE 300MM	METER	562		562		
* 78100100	RAISED REFLECTIVE PAVEMENT MARKER	EACH	1,268		1,268		
* 78100105	RAISED REFLECTIVE PAVEMENT MARKER (BRIDGE)	EACH	37		37		
* 78200100	MONODIRECTIONAL PRISMATIC BARRIER REFLECTOR	EACH	262		262		
* 78200420	GUARDRAIL MARKERS, TYPE B	EACH	13		13		
* 78200530	BARRIER WALL MARKERS, TYPE C	EACH	352		352		
* 78201000	TERMINAL MARKER - DIRECT APPLIED	EACH	1		1		
M7830100	PAVEMENT MARKING REMOVAL	SQ M	204		204		
* M8120130	CONDUIT EMBEDDED IN STRUCTURE, 65MM DIA. GALVANIZED STEEL	METER	88				88
* M8120270	CONDUIT EMBEDDED IN STRUCTURE, 100MM DIA. PVC	METER	54				54
* M8150200	TRENCH AND BACKFILL FOR ELECTRICAL WORK	METER	525				525
MX030504	TEMPORARY PAVEMENT (INTERSTATE)	SO M	2,156		2,156		

* SPECIALTY ITEMS

Δ SFTY - 30

SQ-4

REVISIONS		ILLINOIS DEPARTMENT OF TRANSPORTATION F.A.I. ROUTE 80/94 (INTERSTATE 80/294)
NAME	DATE	
		<p align="center">SUMMARY OF QUANTITIES</p> <p align="right">DRAWN BY: AAS CHECKED BY: RCH</p> <p>DATE: JULY 18, 2005</p> <p align="right">  McDonough Associates Inc. <small>Engineers / Architects</small> </p>

F.A.I. RTE.	SECTION	COUNTY	TOTAL SHEETS	SHEET NO.
80/94	*	COOK	231	10
STA.		TO STA.		
FED. ROAD DIST. NO. 1		ILLINOIS	FED. AID PROJECT	
*(0203.1 & 0304) R-6		CONTRACT # 62105		

CODE NO.	PAY ITEM	UNIT	URBAN 90% FED. 10% STATE TOTAL QUANTITY	CONSTRUCTION TYPE CODE		
				ROADWAY J000-2A	SIGNING Y002-1C	ELECTRICAL WORK Y030-1E
MX030505	STORM SEWERS TO BE GROUTED	CU M	107	107		
X0301229	ACCIDENT INVESTIGATION SITE	CAL MO	12	12		
* MX032160	CONDUIT ENCASED, REINFORCED CONCRETE, 100 MM DIA. PVC, 2 WIDE X 1 HIGH	METER	202			202
MX032178	TEMPORARY INFORMATION SIGNING	SQ M	6	6		
X0323879	SERVICE PATROL	CAL DA	668	668		
X0324044	EROSION CONTROL, TEMPORARY PIPE SLOPE DRAIN	EACH	5	5		
X0324045	SEDIMENT CONTROL STABILIZED CONSTRUCTION ENTRANCE REMOVAL	EACH	3	3		
X0324698	APPLY DUST SUPPRESSION AGENTS	UNIT	243	243		
MX033183	SOIL STABILIZERS	KG	216,000	216,000		
MX033234	SLOTTED DRAIN REMOVAL	METER	346	346		
MX033290	SEDIMENT CONTROL, SILT FENCE	METER	3,210	3,210		
MX033291	SEDIMENT CONTROL, SILT FENCE MAINTENANCE	METER	3,210	3,210		
MX033292	SEDIMENT CONTROL STABILIZED CONSTRUCTION ENTRANCE	SQM	408	408		
MX033303	SEDIMENT CONTROL STABILIZED CONSTRUCTION ENTRANCE MAINTENANCE	SQM	816	816		
X0504200	CONCRETE HEADWALL	EACH	4	4		
X0976500	END SECTIONS TO BE REMOVED	EACH	2	2		
X6020166	DRAINAGE STRUCTURES, TYPE 1 SPECIAL WITH TWO TYPE 20 FRAME AND GRATES	EACH	6	6		
X6020167	DRAINAGE STRUCTURES, TYPE 2 SPECIAL WITH TWO TYPE 22 FRAME AND GRATES	EACH	2	2		
MX602340	CATCH BASINS, 1.2M BY 1.5M, TYPE 22 FRAME AND GRATE	EACH	1	1		
X6700410	ENGINEER'S FIELD OFFICE, TYPE A (SPECIAL)	CAL MO	12	12		
X7011015	TRAFFIC CONTROL AND PROTECTION (EXPRESSWAYS)	L SUM	1	1		
X7013820	TRAFFIC CONTROL SURVEILLANCE, EXPRESSWAYS	CAL DA	288	288		
X7015000	CHANGEABLE MESSAGE SIGN	CAL MO	8	8		
MX704200	REMOVE TEMPORARY CONCRETE BARRIER	METER	4,884	4,884		
MZ001050	AGGREGATE SUBGRADE 300MM	SO M	1,378	1,378		
Z0013798	CONSTRUCTION LAYOUT	L SUM	1	1		
<input type="checkbox"/> Z0029999	IMPACT ATTENUATOR REMOVAL	EACH	5	5		
<input type="checkbox"/> Z0030270	IMPACT ATTENUATORS, TEMPORARY (FULLY REDIRECTIVE, WIDE), TEST LEVEL 3	EACH	4	4		
<input type="checkbox"/> Z0076600	TRAINEES	HOUR	500	500		

- SFTY-3N
- Y080
- * SPECIALTY ITEMS

SQ-5

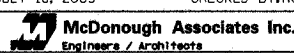
REVISIONS		ILLINOIS DEPARTMENT OF TRANSPORTATION F.A.I. ROUTE 80/94 (INTERSTATE 80/294)
NAME	DATE	
		SUMMARY OF QUANTITIES DATE: JULY 18, 2005 DRAWN BY: AAS CHECKED BY: RCH 

F.A.I. RTE.	SECTION	COUNTY	TOTAL SHEETS	SHEET NO.
80/94	*	COOK	231	11
STA.		TO STA.		
FED. ROAD DIST. NO. 1		ILLINOIS	FED. AID PROJECT	
*(0203.1 & 0304) R-6			CONTRACT # 62105	

CODE NO.	PAY ITEM	UNIT	URBAN 90% FED. 10% STATE TOTAL QUANTITY	CONSTRUCTION TYPE CODE		
				ROADWAY J000-2A	SIGNING Y002-1C	ELECTRICAL WORK Y030-1E
MZ013825	CONTROLLED LOW-STRENGTH MATERIAL	CU M	107	107		
MZ065755	SLOTTED DRAIN 300MM WITH VARIABLE SLOT HEIGHT	METER	160	160		
MX637160	CONCRETE BARRIER, SINGLE FACE, 1065 MM HEIGHT, REINFORCED	METER	101	101		
M6360205	CONCRETE GLARE SCREEN, SPECIAL	METER	29	29		
*MX033544	CONDUIT EMBEDDED IN STRUCTURE, 30MM DIA. CNC, 2 WIDE X 1 HIGH	METER	40			40
*MX033545	CONDUIT EMBEDDED IN STRUCTURE, 30MM DIA. CNC, 4 WIDE X 2 HIGH	METER	1,134			1,134
*MX010115	CONDUIT ENCASED, REINFORCED CONCRETE, 30MM DIA.CNC, 4 WIDE X 2 HIGH	METER	329			329
MX033546	DRAINAGE STRUCTURES, 3.0M BY 0.9, SPECIAL WITH TWO TYPE 20 FRAME AND GRATES	EACH	1	1		
*M7290100	METAL POST - TYPE A	EACH	2			2
*M7800212	PAINT PAVEMENT MARKING - LINE 125MM (SPECIAL)	METER	59	59		
*M7802012	POLYUREA PAVEMENT MARKING TYPE I - LINE 125MM	METER	2,909	2,909		
MX033547	SLIP-ON FLAT BOTTOM CHECK VALVE 375MM	EACH	2	2		
MX033548	SLIP-ON FLAT BOTTOM CHECK VALVE 750MM	EACH	2	2		
*X0325130	TUBULAR TRAFFIC SIGN POST	EACH	13			13
*X0325131	HIGHWAY ADVISORY RADIO FLASHING BEACON ASSEMBLY, SOLAR	EACH	1			1

* SPECIALTY ITEMS

50-6

REVISIONS		ILLINOIS DEPARTMENT OF TRANSPORTATION F.A.I. ROUTE 80/94 (INTERSTATE 80/294)
NAME	DATE	
		SUMMARY OF QUANTITIES
DATE: JULY 18, 2005		DRAWN BY: AAS CHECKED BY: RCH
 McDonough Associates Inc. Engineers / Architects		

...Contract 18116150238.dgn B/27/05 5:52:06 AM

M7240330 REMOVE SIGN PANEL - TYPE 3

STATION	OFFSET	LENGTH M	WIDTH M	AREA SQ M	DESCRIPTION
3+510.17	LT	2.9	4.6	13.3	LANE MERGE ARROW
3+112.00	LT	3.2	2.4	7.8	SOUTH 394
3+174.00	RT	2.7	2.2	5.7	END 294
3+190.00	RT	3.2	4.9	15.7	TORRENCE AVE
3+278.00	LT	3.2	2.4	7.8	SOUTH 394
3+500.00	RT	4.2	2.0	8.2	WEST 6 / 83
3+510.17	LT	2.9	4.6	13.3	WEST 6 / 83
160+233.00	RT	3.3	2.4	7.9	RTE 6/83 0.5 MILE
31+518.00		3.5	7.5	25.7	80/294 WISCONSIN IOWA
TOTAL					106

M7030520 PAVEMENT MARKING TAPE, TYPE III 100MM

DRAWING NO.	BEGIN STATION	END STATION	LENGTH (METER)	DESCRIPTION	
MT-7	160+239.9	160+340.3	201	RAMP L (LT. & RT. EDGE)	
MT-8	3+986.9	4+102.5	116	I-80 WB (LEFT EDGE)	
	31+358.3	31+382.9	25	I-94 WB (RIGHT EDGE)	
	31+495.5	31+500.0	5	I-80 / 94 WB	
MT-9	31+500.0	31+554.4	54	I-80 / 94 WB (LEFT EDGE)	
	31+500.0	31+504.4	4	I-94 WB (LEFT EDGE)	
MT-11	2+786.0	2+967.7	182	I-80 WB (RIGHT EDGE)	
	2+786.0	3+050.0	264	RAMP H, RIGHT EDGE	
	3+001.8	3+050.0	48	RAMP H, LEFT EDGE	
	2+982.8	3+050.0	67	RAMP L, RIGHT EDGE	
MT-12	3+148.7	3+245.5	97	RAMP L, LEFT EDGE	
	3+050.0	3+245.5	196	RAMP L, RIGHT EDGE	
	160+000.0	160+150.0	300	RAMP L (LT. & RT. EDGE)	
	3+050.0	3+136.4	173	RAMP H (LT. & RT. EDGE)	
	130+835.0	131+100.0	530	RAMP H (LT. & RT. EDGE)	
MT-13	160+150.0	160+340.3	381	RAMP L (LT. & RT. EDGE)	
	130+750.0	130+835.0	170	RAMP H (LT. & RT. EDGE)	
	3+550.0	3+650.0	200	I-80 EB (LEFT EDGE)	
MT-14	130+725.0	130+750.0	50	RAMP H (LT. & RT. EDGE)	
MT-15	2+857.7	3+050.0	385	I-80 WB (LT. & RT. EDGE)	
	2+857.7	3+050.0	385	I-80 EB (LT. & RT. EDGE)	
MT-16	3+050.0	3+400.0	700	I-80 EB & WB (LEFT EDGE)	
	3+050.0	3+318.2	268	I-80 WB (RIGHT EDGE)	
	3+352.5	3+400.0	48	I-80 WB (RIGHT EDGE)	
	3+050.0	3+289.8	240	I-80 EB (RIGHT EDGE)	
	130+835.0	130+884.4	49	RAMP H (LEFT EDGE)	
	130+835.0	130+918.1	83	RAMP H (RIGHT EDGE)	
	160+044.4	160+150.0	106	RAMP L (RIGHT EDGE)	
MT-17	3+400.0	3+750.0	700	I-80 WB (LT. & RT. EDGE)	
	130+820.0	130+835.0	30	RAMP H (LT. & RT. EDGE)	
	3+400.0	3+750.0	350	I-80 EB (LEFT EDGE)	
	3+451.0	3+750.0	299	I-80 EB (RIGHT EDGE)	
	160+205.5	160+265.6	60	RAMP L, LEFT EDGE	
	160+150.0	160+265.6	116	RAMP L, RIGHT EDGE	
MT-18	31+354.3	31+382.9	29	I-94 WB (LEFT EDGE)	
	3+750.0	3+985.5	236	I-80 WB (RIGHT EDGE)	
	3+750.0	4+100.0	700	I-80 EB (LT. & RT. EDGE)	
	3+750.0	4+100.0	350	I-80 WB (LEFT EDGE)	
MT-19	31+500.0	31+583.0	166	I-80 / 94 WB (LT. & RT. EDGE)	
TOTAL					8,359

M7030530 PAVEMENT MARKING TAPE, TYPE III 125MM

DRAWING NO.	BEGIN STATION	END STATION	LENGTH (METER)	DESCRIPTION	
MT-13	3+550.0	3+650.0	25	I-80 EB, SKIP-DASH	
MT-15	2+857.7	3+050.0	48	I-80 WB, SKIP-DASH	
	2+857.7	3+050.0	48	I-80 WB, SKIP-DASH	
	2+857.7	3+050.0	48	I-80 EB, SKIP-DASH	
MT-16	3+050.0	3+400.0	88	I-80 WB, SKIP-DASH	
	3+050.0	3+318.2	67	I-80 WB, SKIP-DASH	
	3+050.0	3+400.0	88	I-80 EB, SKIP-DASH	
MT-17	3+400.0	3+750.0	88	I-80 WB, SKIP-DASH	
	3+400.0	3+750.0	88	I-80 EB, SKIP-DASH	
MT-18	3+750.0	4+102.5	88	I-80 WB, SKIP-DASH	
	3+750.0	4+100.0	88	I-80 EB, SKIP-DASH	
MT-19	31+500.0	31+583.0	21	I-80 / 94 WB, SKIP-DASH	
TOTAL					783

M7030550 PAVEMENT MARKING TAPE, TYPE III 200MM

DRAWING NO.	BEGIN STATION	END STATION	LENGTH (METER)	DESCRIPTION	
MT-8	31+382.9	31+495.5	113	I-80 / 94 GORE	
MT-8	3+986.9	4+098.0	111	I-80 / 94 GORE	
MT-11	2+900.0	3+001.8	204	I-80 / RAMP H GORE	
MT-11	3+042.8	3+050.0	14	I-80 / RAMP L GORE	
MT-12	3+050.0	3+148.7	197	I-80 / RAMP L GORE	
MT-16	3+318.2	3+352.5	69	I-80 / RAMP H GORE	
MT-17	160+150.0	160+205.5	111	I-80 / RAMP L GORE	
MT-18	31+382.9	31+500.0	234	I-80 / 94 GORE	
TOTAL					1,053

M7030560 PAVEMENT MARKING TAPE, TYPE III 300MM

DRAWING NO.	BEGIN STATION	END STATION	LENGTH (METER)	DESCRIPTION	
MT-8	3+986.9	4+098.0	72	I-80 / 94 GORE	
MT-11	2+900.0	3+001.8	66	I-80 / RAMP H GORE	
MT-12	3+042.8	3+148.7	66	I-80 / RAMP L GORE	
MT-16	3+318.2	3+352.5	22	I-80 / RAMP H GORE	
MT-17	160+150.0	160+205.5	39	I-80 / RAMP L GORE	
MT-18	31+382.9	31+500.0	77	I-80 / 94 GORE	
TOTAL					341

M7800605 EPOXY PAVEMENT MARKING - LINE 100MM

DRAWING NO.	BEGIN STATION	END STATION	LENGTH (METER)	DESCRIPTION	
MT-5	2+967.7	3+050.0	165	I-80 WB (LT. & RT. EDGE)	
	2+967.7	3+050.0	165	I-80 EB (LT. & RT. EDGE)	
MT-6	3+050.0	3+400.0	350	I-80 WB (LT. EDGE)	
	3+050.0	3+352.0	302	I-80 WB (RT. EDGE)	
	3+336.6	3+400.0	63	I-80 WB (RT. EDGE)	
	3+050.0	3+400.0	350	I-80 EB (LT. EDGE)	
	3+050.0	3+375.0	325	I-80 EB + RAMP L (RT. EDGE)	
	160+128.9	160+150.0	42	RAMP L (LT. & RT. EDGE)	
	3+375.0	3+400.0	25	I-80 EB (RT. EDGE)	
MT-7	3+400.0	3+750.0	700	I-80 WB (LT. & RT. EDGE)	
	3+400.0	3+550.0	300	I-80 EB (LT. & RT. EDGE)	
	160+150.0	160+239.9	180	RAMP L (LT. & RT. EDGE)	
MT-8	3+750.0	3+986.9	474	I-80 WB (LT. & RT. EDGE)	
MT-12	3+200.0	3+400.0	400	I-80 EB (LT. & RT. EDGE)	
MT-13	3+400.0	3+550.0	300	I-80 EB (LT. & RT. EDGE)	
TOTAL					4,140

M7800610 EPOXY PAVEMENT MARKING - LINE 125MM

DRAWING NO.	BEGIN STATION	END STATION	LENGTH (METER)	DESCRIPTION	
MT-5	2+967.7	3+050.0	21	I-80 EB, SKIP-DASH	
0	2+967.7	3+050.0	21	I-80 WB, SKIP-DASH	
MT-6	3+050.0	3+400.0	88	I-80 EB, SKIP-DASH	
0	3+050.0	3+400.0	88	I-80 WB, SKIP-DASH	
MT-7	3+400.0	3+550.0	38	I-80 EB, SKIP-DASH	
0	3+400.0	3+750.0	88	I-80 WB, SKIP-DASH	
MT-8	3+750.0	4+102.5	88	I-80 WB, SKIP-DASH	
MT-9	31+500.0	31+554.4	14	I-80 / 94, SKIP-DASH	
MT-11	2+786.0	2+967.7	45	I-80 WB, SKIP-DASH	
MT-12	3+200.0	3+400.0	50	I-80 EB, SKIP-DASH	
MT-13	3+400.0	3+550.0	38	I-80 EB, SKIP-DASH	
TOTAL					576

M7800620 EPOXY PAVEMENT MARKING - LINE 200MM

DRAWING NO.	BEGIN STATION	END STATION	LENGTH (METER)	DESCRIPTION	
MT-6	3+336.6	3+352.0	15	RAMP H (LEFT EDGE)	
	3+303.0	3+375.0	72	I-80 EB (RIGHT EDGE)	
	3+303.0	3+375.0	72	RAMP L (LEFT EDGE)	
TOTAL					159

M7800625 EPOXY PAVEMENT MARKING - LINE 300MM

DRAWING NO.	BEGIN STATION	END STATION	LENGTH (METER)	DESCRIPTION	
MT-6	3+303.0	3+375.0	44	RAMP L GORE STRIPING	
TOTAL					44

SC-2

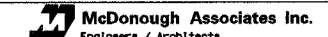
REVISIONS		ILLINOIS DEPARTMENT OF TRANSPORTATION F.A.I. ROUTE 80/94 (INTERSTATE 80/294)
NAME	DATE	
		SCHEDULE OF QUANTITIES DATE: JULY 18, 2005 DRAWN BY: CTT CHECKED BY: RCH 

EARTHWORK SCHEDULE - I-80

BEGIN STATION	END STATION	EARTH EXCAVATION	REMOVAL AND DISPOSAL OF UNSUITABLE MATERIAL	EXCAVATION TO BE USED IN EMBANKMENT ADJUSTED FOR SHRINKAGE*	EMBANKMENT	EARTHWORK BALANCE WASTE (+) OR SHORTAGE (-)	POROUS GRANULAR EMBANKMENT, SUBGRADE
		CU. M.	CU. M.	CU. M.	CU. M.	CU. M.	CU. M.
2+967.68	2+975.00	180	20	155	65	90	0
2+975.00	3+000.00	915	40	780	115	665	0
3+000.00	3+025.00	1,090	50	925	290	635	0
3+025.00	3+050.00	1,015	65	865	415	450	0
3+050.00	3+075.00	1,090	65	925	315	610	0
3+075.00	3+100.00	1,150	90	980	400	580	0
3+100.00	3+125.00	1,165	75	990	740	250	0
3+125.00	3+150.00	1,165	65	990	1,050	-60	0
3+150.00	3+175.00	1,275	90	1,085	750	335	0
3+175.00	3+200.00	1,500	65	1,275	215	1,060	0
3+200.00	3+225.00	1,575	40	1,340	0	1,340	0
3+225.00	3+250.00	1,600	65	1,360	0	1,360	0
3+250.00	3+275.00	1,765	65	1,500	0	1,500	0
3+275.00	3+300.00	1,850	40	1,575	75	1,500	0
3+300.00	3+325.00	1,865	25	1,585	190	1,395	0
3+325.00	3+350.00	1,875	50	1,595	190	1,405	0
3+350.00	3+375.00	1,890	65	1,605	75	1,530	0
3+375.00	3+400.00	1,640	65	1,395	25	1,370	0
3+400.00	3+425.00	1,300	65	1,105	40	1,065	0
3+425.00	3+450.00	1,100	65	935	25	910	0
3+450.00	3+475.00	915	65	780	40	740	0
3+475.00	3+500.00	725	50	615	65	550	0
3+500.00	3+525.00	540	50	460	115	345	0
3+525.00	3+550.00	390	65	330	215	115	0
3+550.00	3+575.00	190	65	160	290	-130	0
3+575.00	3+600.00	40	50	35	350	-315	0
3+600.00	3+625.00	25	40	20	500	-480	0
3+625.00	3+650.00	25	25	20	640	-620	0
3+650.00	3+675.00	25	40	20	600	-580	0
3+675.00	3+700.00	25	40	20	465	-445	0
3+700.00	3+725.00	340	25	290	275	15	0
3+725.00	3+750.00	600	25	510	115	395	0
3+750.00	3+775.00	565	25	480	65	415	0
3+775.00	3+800.00	450	25	385	50	335	0
3+800.00	3+825.00	200	15	170	90	80	0
3+825.00	3+850.00	115	0	100	90	10	0
3+850.00	3+875.00	190	0	160	50	110	0
3+875.00	3+900.00	175	0	150	50	100	0
3+900.00	3+925.00	125	0	105	65	40	0
3+925.00	3+950.00	125	0	105	100	5	0
3+950.00	3+975.00	100	0	85	90	-5	0
3+975.00	4+000.00	90	0	75	125	-50	0
4+000.00	4+025.00	100	0	85	215	-130	0
4+025.00	4+050.00	90	0	75	225	-150	0
4+050.00	4+075.00	75	0	65	225	-160	0
4+075.00	4+100.00	50	0	45	225	-180	0
4+100.00	4+125.00	25	0	20	225	-205	0
4+125.00	4+150.00	25	0	20	225	-205	0
4+150.00	4+175.00	25	0	20	225	-205	0
4+175.00	4+200.00	25	0	20	225	-205	0
4+200.00	4+225.00	25	0	20	215	-195	0
4+225.00	4+250.00	25	0	20	175	-155	0
4+250.00	4+275.00	25	0	20	125	-105	0
4+275.00	4+300.00	40	0	35	90	-55	0
4+300.00	4+325.00	50	0	45	65	-20	0
4+325.00	4+350.00	50	0	45	40	5	0
4+350.00	4+375.00	50	0	45	40	5	0
4+375.00	4+400.00	40	0	35	75	-40	0
4+400.00	4+425.00	40	0	35	140	-105	0
4+425.00	4+450.00	50	0	45	215	-170	0
4+450.00	4+475.00	50	0	45	300	-255	0
4+475.00	4+500.00	50	0	45	390	-345	0
SUB TOTAL		33,890	1,775	28,825	13,080	15,745	0

DESCRIPTION	TOTAL	UNIT
EARTH EXCAVATION	35,725	CU M
REMOVAL AND DISPOSAL OF UNSUITABLE MATERIAL	2,020	CU M
FURNISHED EXCAVATION	0	CU M
POROUS GRANULAR EMBANKMENT, SUBGRADE	0	CU M

F.A.I. RTE. 80/94	SECTION *	COUNTY COOK	TOTAL SHEETS 231	SHEET NO. 15
STA.		TO STA.		
FED. ROAD DIST. NO. 1		ILLINOIS FED. AID PROJECT		
*(0203.1 & 0304) R-6		CONTRACT # 62105		

EARTHWORK SCHEDULE - RAMP H

BEGIN STATION	END STATION	EARTH EXCAVATION	REMOVAL AND DISPOSAL OF UNSUITABLE MATERIAL	EXCAVATION TO BE USED IN EMBANKMENT ADJUSTED FOR SHRINKAGE*	EMBANKMENT	EARTHWORK BALANCE WASTE (+) OR SHORTAGE (-)	POROUS GRANULAR EMBANKMENT, SUBGRADE
		CU. M.	CU. M.	CU. M.	CU. M.	CU. M.	CU. M.
130+750.00	130+775.00	365	65	310	0	310	0
130+775.00	130+800.00	615	90	525	0	525	0
130+800.00	130+825.00	440	40	375	0	375	0
130+825.00	130+850.00	265	25	225	0	225	0
130+850.00	130+875.00	150	25	130	0	130	0
SUB TOTAL		1,835	245	1,565	0	1,565	0

* ASSUME 15% FOR SHRINKAGE

SC-4

REVISIONS		ILLINOIS DEPARTMENT OF TRANSPORTATION F.A.I. ROUTE 80/94 (INTERSTATE 80/294)
NAME	DATE	
DATE: JULY 18, 2005		DRAWN BY: CTT CHECKED BY: RCH
 McDonough Associates Inc. Engineers / Architects		

F.A.I. RTE. 80/94	SECTION *	COUNTY COOK	TOTAL SHEETS 231	SHEET NO. 16
STA.		TO STA.		
FED. ROAD DIST. NO. 1		ILLINOIS FED. AID PROJECT		
*(0203.1 & 0304) R-6		CONTRACT # 62105		

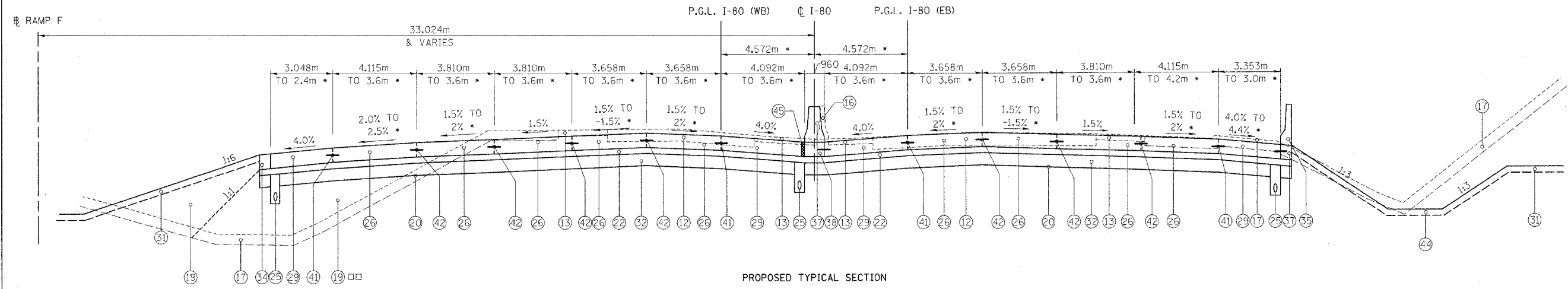

PROPOSED TYPICAL SECTION
STA. 2+967.681 TO STA. 3+144.453 \bar{C} I-80 (EB & WB)

*PAVEMENT, SHOULDERS AND CROWN TRANSITIONS FROM STA. 3+040.805 TO STA. 3+116.526. FOR DETAILS SEE SHEETS PD-1 AND PD-2

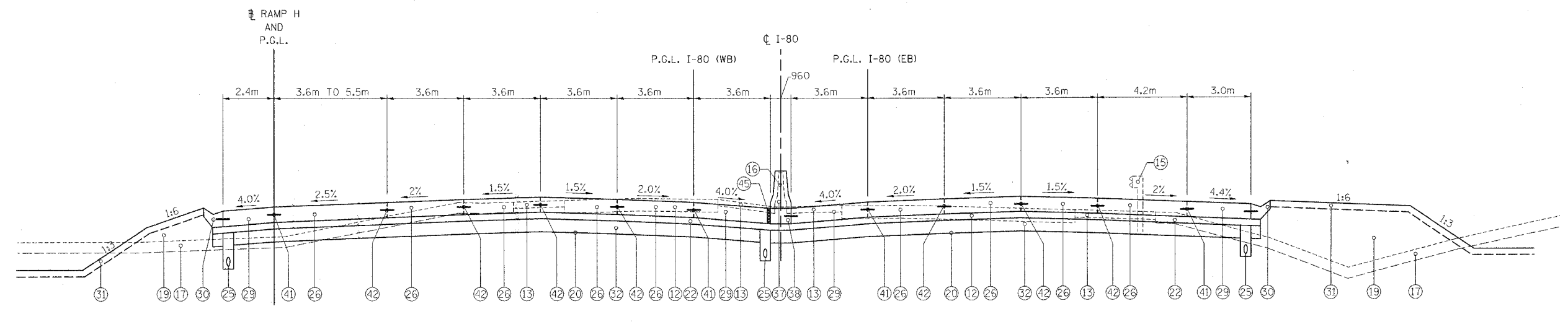

PROPOSED TYPICAL SECTION
STA. 3+144.453 TO STA. 3+224.474 \bar{C} I-80 (EB & WB)
STA. 131+012.000 TO STA. 131+091.936 \bar{C} RAMP H

NOTES:
□ ITEM TO BE CONSTRUCTED TO EXTENDED LIFE CONCRETE PAVEMENT (30 YEAR) SPECIFICATIONS
FOR LEGEND AND NOTES SEE TS-4

REVISIONS		ILLINOIS DEPARTMENT OF TRANSPORTATION F.A.I. ROUTE 80/94 (INTERSTATE 80/294)
NAME	DATE	
		<p style="text-align: center;">TYPICAL SECTIONS</p> <p style="text-align: right;">DRAWN BY: CTT CHECKED BY: RCH</p> <p style="text-align: right;">DATE: JULY 18, 2005</p> <p style="text-align: right;">McDonough Associates Inc. Engineers / Architects</p>

TS-1

F.A.I. RTE.	SECTION	COUNTY	TOTAL SHEETS	SHEET NO.
80/94	*	COOK	231	17
STA.		TO STA.		
FED. ROAD DIST. NO. 1		ILLINOIS FED. AID PROJECT		
*(0203.1 & 0304) R-6		CONTRACT * 62105		

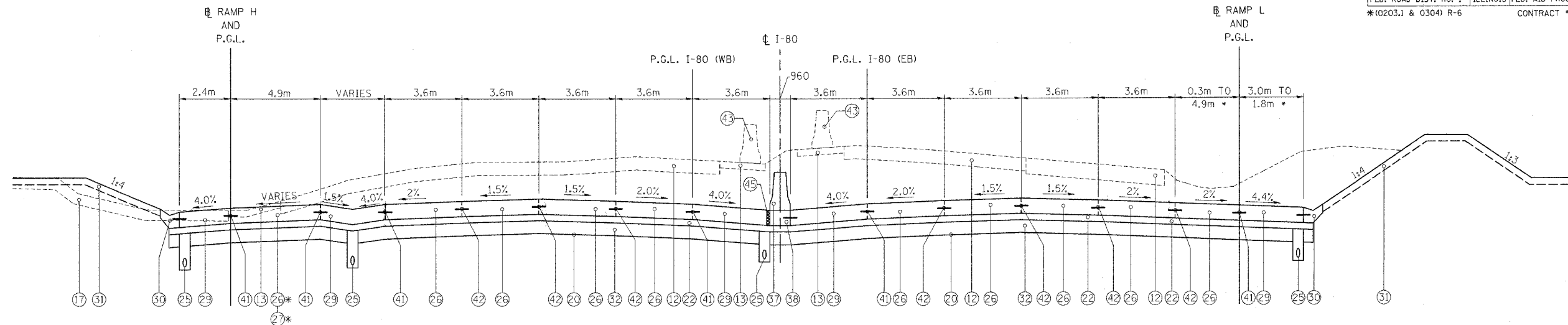

PROPOSED TYPICAL SECTION
 STA. 3+224.474 TO STA. 3+371.049 @ I-80 (EB & WB)
 STA. 130+882.000 TO STA. 131+012.000 @ RAMP H
 STA. 160+000.000 TO STA. 160+125.505 @ RAMP L

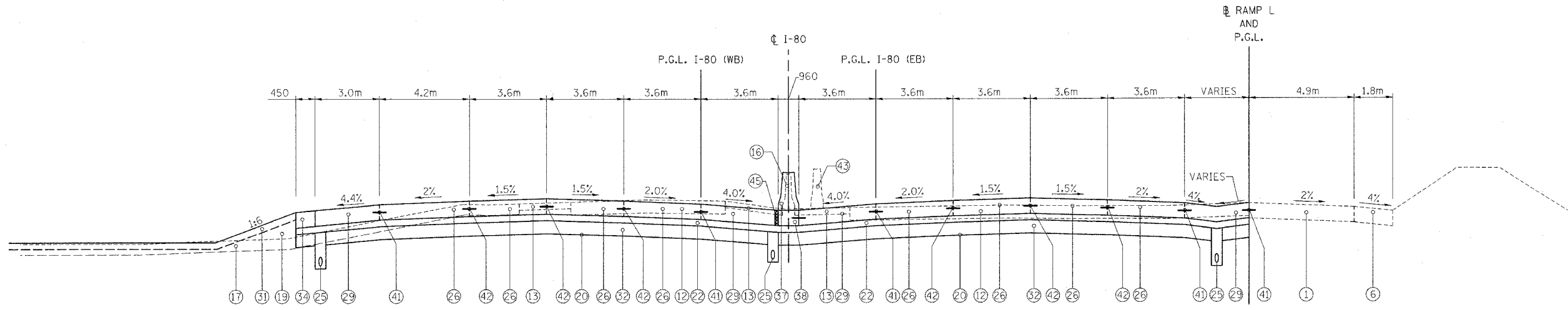

PROPOSED TYPICAL SECTION
 STA. 3+371.049 TO STA. 3+451.016 @ I-80 (EB & WB)
 STA. 160+125.505 TO STA. 160+205.492 @ RAMP L

NOTES:
 [] ITEM TO BE CONSTRUCTED TO EXTENDED LIFE CONCRETE PAVEMENT (30 YEAR) SPECIFICATIONS
 FOR LEGEND AND NOTES SEE TS-4

REVISIONS	
NAME	DATE

ILLINOIS DEPARTMENT OF TRANSPORTATION
 F.A.I. ROUTE 80/94 (INTERSTATE 80/294)
 TYPICAL SECTIONS
 DATE: JULY 18, 2005
 DRAWN BY: CTT
 CHECKED BY: RCH
McDonough Associates Inc.
 Engineers / Architects

TS-2

F.A.I. RTE.	SECTION	COUNTY	TOTAL SHEETS	SHEET NO.
80/94	*	COOK	231	18
STA.	TO STA.			
FED. ROAD DIST. NO. 1	ILLINOIS	FED. AID PROJECT		
*(0203.1 & 0304) R-6			CONTRACT # 62105	

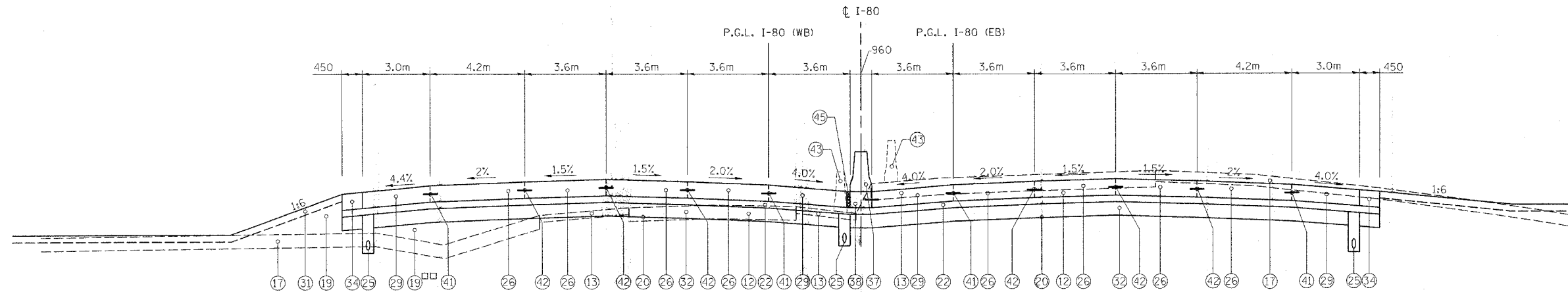

PROPOSED TYPICAL SECTION
STA. 3+451.016 TO STA. 3+550.000 I-80 (EB & WB)

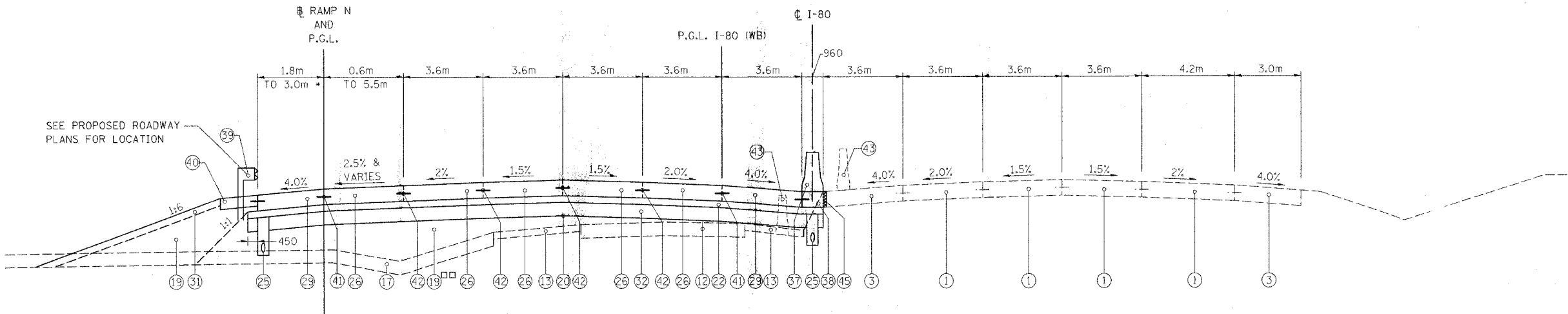

PROPOSED TYPICAL SECTION
STA. 3+550.000 TO STA. 3+807.070 I-80 (WB)
STA. 180+230.876 TO STA. 180+476.334 RAMP N
* SEE PROPOSED ROADWAY PLANS FOR LOCATION

NOTES:
 ITEM TO BE CONSTRUCTED TO EXTENDED LIFE CONCRETE PAVEMENT (30 YEAR) SPECIFICATIONS
 FOR LEGEND AND NOTES SEE TS-4

TS-3

REVISIONS		ILLINOIS DEPARTMENT OF TRANSPORTATION F.A.I. ROUTE 80/94 (INTERSTATE 80/294)
NAME	DATE	
		TYPICAL SECTIONS

DATE: JULY 18, 2005
 DRAWN BY: CTT
 CHECKED BY: RCH

McDonough Associates Inc.
 Engineers / Architects

F.A.I. RTE.	SECTION	COUNTY	TOTAL SHEETS	SHEET NO.
80/94	*	COOK	231	19
STA.		TO STA.		
FED. ROAD DIST. NO. 1		ILLINOIS FED. AID PROJECT		
*(0203.1 & 0304) R-6		CONTRACT # 62105		

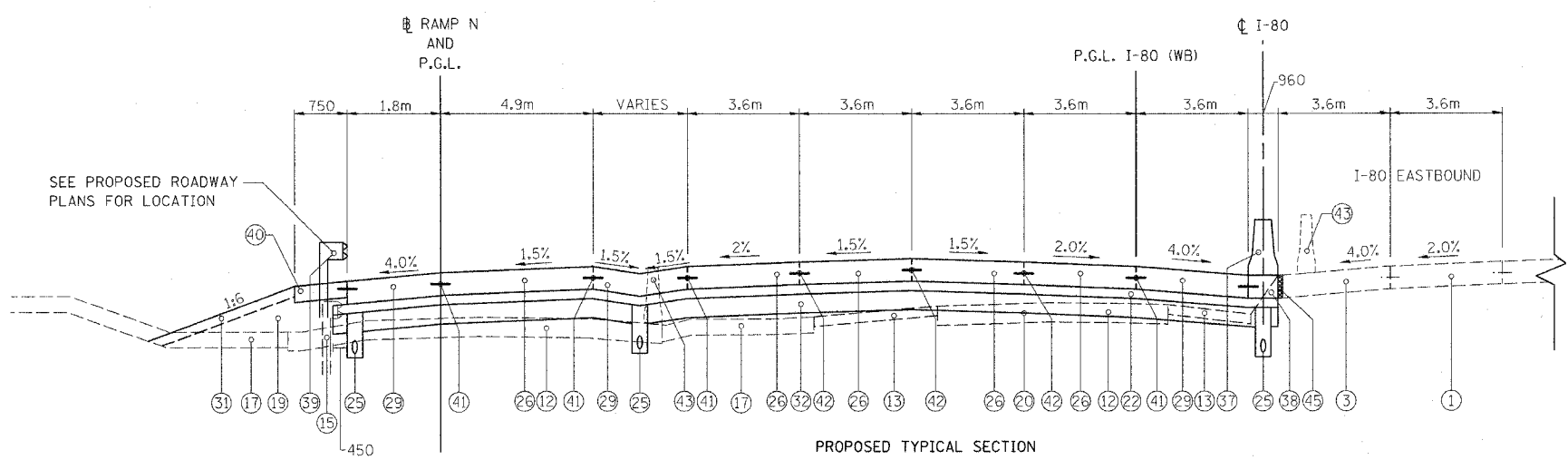

PROPOSED TYPICAL SECTION
 STA. 3+807.070 TO STA. 3+956.896 @ I-80 (WB)
 STA. 180+081.020 TO STA. 180+230.876 @ RAMP N

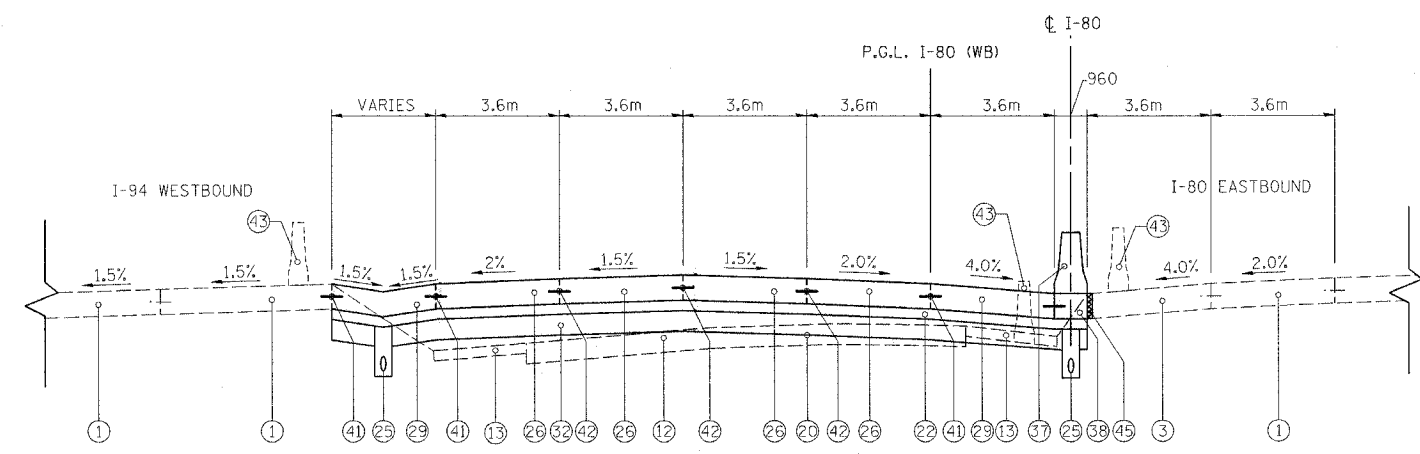

PROPOSED TYPICAL SECTION
 STA. 3+956.896 TO STA. 4+095.530 @ I-80 (WB)

- LEGEND**
- □ ITEM TO BE CONSTRUCTED TO EXTENDED LIFE CONCRETE PAVEMENT SPECIFICATIONS
 - ① EXISTING PAVEMENT
 - ② EXISTING JOINTED CONCRETE PAVEMENT, 250 MM
 - ③ EXISTING SHOULDER
 - ④ EXISTING SELECTED SUBGRADE, 250 MM
 - ⑤ EXISTING CONCRETE GUTTER, TYPE G-3
 - ⑥ EXISTING PAVEMENT (150 MM BITUMINOUS OVERLAY, 275 MM CONCRETE)
 - ⑦ EXISTING SHOULDER (SEE NOTE 6)
 - ⑧ EXISTING GUARDRAIL
 - ⑨ EXISTING CONCRETE BARRIER
 - ⑩ EXISTING COMBINATION CURB AND GUTTER
 - ⑪ EXISTING MECHANICALLY STABILIZED EARTH RETAINING WALL
 - ⑫ PAVEMENT REMOVAL/PAVEMENT BREAKING, 425mm
 - ⑬ PAVED SHOULDER REMOVAL, (SEE NOTE 6)
 - ⑭ COMBINATION CURB AND GUTTER REMOVAL
 - ⑮ GUARDRAIL REMOVAL
 - ⑯ CONCRETE BARRIER & BASE REMOVAL
 - ⑰ REMOVAL AND DISPOSAL OF UNSUITABLE MATERIAL
 - ⑱ EARTH EXCAVATION
 - ⑲ PROPOSED EMBANKMENT (SEE NOTE 7)
 - ⑳ PROPOSED GEOTECHNICAL FABRIC FOR GROUND STABILIZATION □ □
 - ㉑ PROPOSED STABILIZED SUBBASE (BAM), 100 MM
 - ㉒ PROPOSED STABILIZED SUBBASE, 150 MM □ □
 - ㉓ PROPOSED AGGREGATE SUBGRADE, 300 MM
 - ㉔ NOT USED
 - ㉕ PROPOSED PIPE UNDERDRAINS, 150 MM
 - ㉖ PROPOSED CONTINUOUSLY REINFORCED PORTLAND CEMENT CONCRETE PAVEMENT, 360 MM □ □
 - ㉗ PROPOSED PORTLAND CEMENT CONCRETE PAVEMENT (JOINTED), 280MM
 - ㉘ PROPOSED PORTLAND CEMENT CONCRETE SHOULDERS, 280 MM
 - ㉙ PROPOSED PORTLAND CEMENT CONCRETE SHOULDERS, 360 MM □ □
 - ㉚ PROPOSED CONCRETE GUTTER, TYPE A (MODIFIED)
 - ㉛ TOPSOIL FURNISH AND PLACE, 150 MM
 - ㉜ PROPOSED SUBBASE GRANULAR MATERIAL, TYPE B, 300 MM □ □
 - ㉝ PROPOSED AGGREGATE SHOULDERS, TYPE B, 280 MM
 - ㉞ PROPOSED AGGREGATE SHOULDERS, TYPE B, 360 MM
 - ㉟ PROPOSED CONCRETE BARRIER, SINGLE FACE, 1065 HEIGHT, REINFORCED
 - ㊱ PROPOSED CONCRETE BARRIER, DOUBLE FACE, 815 HEIGHT
 - ㊲ PROPOSED CONCRETE BARRIER, DOUBLE FACE, 1065 HEIGHT
 - ㊳ PROPOSED CONCRETE BARRIER BASE
 - ㊴ PROPOSED STEEL PLATE BEAM GUARDRAIL
 - ㊵ PROPOSED PORTLAND CEMENT CONCRETE STABILIZATION 150 MM AT STEEL PLATE BEAM GUARDRAIL
 - ㊶ PAVEMENT TO SHOULDER (LONGITUDINAL JOINT) #20 TIE BAR (EPOXY COATED) DRILL & GROUT 600mm LONG @ 600mm C-C
 - ㊷ PAVEMENT TO PAVEMENT (LONGITUDINAL SAWED JOINT) #20 TIE BAR (EPOXY COATED) 750mm LONG @ 750mm C-C OR PAVEMENT TO PAVEMENT (LONGITUDINAL CONSTRUCTION JOINT) #25 TIE BAR (EPOXY COATED) DRILL & GROUT 600mm LONG @ 600mm C-C
 - ㊸ TEMPORARY CONCRETE BARRIER REMOVAL
 - ㊹ PROPOSED DITCH
 - ㊺ BARRIER BASE OPEN JOINT (P/J)

- NOTES**
- ALL DIMENSIONS ARE IN MILLIMETERS UNLESS OTHERWISE NOTED.
 - FOR EXACT LIMITS OF REMOVAL ITEMS SEE EXISTING PLANS.
 - FOR OFFSET AND ELEVATIONS FOR PROPOSED GRADING SEE PROPOSED CROSS SECTIONS.
 - TIE BARS WILL BE MEASURED ACCORDING TO ARTICLE 508.07.
 - OFFSET TO SLOPE BREAK AS SHOWN ON CROSS SECTIONS
 - SHOULDER CORE INFORMATION IS AVAILABLE FROM IDOT.
 - EXTENDED LIFE EMBANKMENT IS SHOWN WHERE APPLICABLE. □ □

"CRC REINFORCEMENT CHART ON STANDARD 421001 SHALL BE MODIFIED AS FOLLOWS:

PAVEMENT WIDTH	A	B	C	D
3.6m	26 SPACES (27 BARS) AT 132mm	90mm	75mm	660mm
4.2m	31 SPACES (32 BARS) AT 130mm	90mm	75mm	660mm
4.9m	35 SPACES (36 BARS) AT 135mm	95mm	85mm	660mm

THE REINFORCEMENT SHALL BE 115mm FROM THE TOP OF PAVEMENT

MIXTURE DESIGN TABLE

MIXTURE TYPE	UNIT	AC TYPE	MAX RAP %	AIR VOIDS	TYPICAL THICKNESS	MIX TYPE
*TEMPORARY PAVEMENT (INTERSTATE) -MAINLINE TEMPORARY PAVEMENT	SQ M	SBS/SBR PG 70-22	0	4% @ 105 GYR	45 mm	** POLYMERIZED BITUMINOUS CONCRETE SURFACE COURSE, SUPERPAVE, MIX F, N105
*TEMPORARY PAVEMENT (INTERSTATE) -SHOULDER WIDENING ADJACENT TO CONSTRUCTION ENTRANCES	SQ M	SBS/SBR PG 64-22	0	4% @ 105 GYR	310 mm	BITUMINOUS CONCRETE BINDER COURSE, SUPERPAVE, IL-19, N105
		PG 64-22	15	4% @ 50 GYR	45 mm	** BITUMINOUS CONCRETE SURFACE COURSE, SUPERPAVE, MIX "D", N50
		PG 58-22	50	2% @ 50 GYR	210 mm	BITUMINOUS BASE COURSE, SUPERPAVE
STABILIZED SUB-BASE 100 MM (4 IN)	SQ M	PG 58-22	50	2% @ 30 GYR	100 mm	BITUMINOUS BASE COURSE, N30
STABILIZED SUB-BASE 150 MM (6 IN)	SQ M	PG 58-22	25	3% @ 50 GYR	150 mm	STABILIZED SUB-BASE, SUPERPAVE, IL-19, N50

*SEE SPECIAL PROVISIONS
 **THE UNIT WEIGHT USED TO CALCULATE ALL BITUMINOUS SURFACES MIXTURE QUANTITIES IS 112 LBS/SQ YD/IN

TS-4

REVISIONS		ILLINOIS DEPARTMENT OF TRANSPORTATION F.A.I. ROUTE 80/94 (INTERSTATE 80/294)
NAME	DATE	
		TYPICAL SECTIONS

DATE: JULY 18, 2005
 DRAWN BY: CTT
 CHECKED BY: RCH

McDonough Associates Inc.
 Engineers / Architects

F.A.I. RTE.	SECTION	COUNTY	TOTAL SHEETS	SHEET NO.
80/94	*	COOK	231	20
STA.		TO STA.		
FED. ROAD DIST. NO. 1		ILLINOIS	FED. AID PROJECT	
*(0203.1 & 0304) R-6		CONTRACT # 62105		

LEGEND

- ITEM TO BE CONSTRUCTED TO EXTENDED LIFE CONCRETE PAVEMENT SPECIFICATIONS
- ① EXISTING PAVEMENT
- ② EXISTING JOINTED CONCRETE PAVEMENT, 250 MM
- ③ EXISTING SHOULDER
- ④ EXISTING SELECTED SUBGRADE, 250 MM
- ⑤ EXISTING CONCRETE GUTTER, TYPE G-3
- ⑥ EXISTING PAVEMENT (150 MM BITUMINOUS OVERLAY, 275 MM CONCRETE)
- ⑦ EXISTING SHOULDER (SEE NOTE 6)
- ⑧ EXISTING GUARDRAIL
- ⑨ EXISTING CONCRETE BARRIER
- ⑩ EXISTING COMBINATION CURB AND GUTTER
- ⑪ EXISTING MECHANICALLY STABILIZED EARTH RETAINING WALL
- ⑫ PAVEMENT REMOVAL/PAVEMENT BREAKING, 425mm
- ⑬ PAVED SHOULDER REMOVAL, (SEE NOTE 6)
- ⑭ COMBINATION CURB AND GUTTER REMOVAL
- ⑮ GUARDRAIL REMOVAL
- ⑯ CONCRETE BARRIER & BASE REMOVAL
- ⑰ REMOVAL AND DISPOSAL OF UNSUITABLE MATERIAL
- ⑱ EARTH EXCAVATION
- ⑲ PROPOSED EMBANKMENT (SEE NOTE 7)
- ⑳ PROPOSED GEOTECHNICAL FABRIC FOR GROUND STABILIZATION □
- ㉑ PROPOSED STABILIZED SUBBASE (BAM), 100 MM
- ㉒ PROPOSED STABILIZED SUBBASE, 150 MM □
- ㉓ PROPOSED AGGREGATE SUBGRADE, 300 MM
- ㉔ NOT USED
- ㉕ PROPOSED PIPE UNDERDRAINS, 150 MM
- ㉖ PROPOSED CONTINUOUSLY REINFORCED PORTLAND CEMENT CONCRETE PAVEMENT, 360 MM □
- ㉗ PROPOSED PORTLAND CEMENT CONCRETE PAVEMENT (JOINTED), 280MM
- ㉘ PROPOSED PORTLAND CEMENT CONCRETE SHOULDERS, 280 MM
- ㉙ PROPOSED PORTLAND CEMENT CONCRETE SHOULDERS, 360 MM □
- ㉚ PROPOSED CONCRETE GUTTER, TYPE A (MODIFIED)
- ㉛ TOPSOIL FURNISH AND PLACE, 150 MM
- ㉜ PROPOSED SUBBASE GRANULAR MATERIAL, TYPE B, 300 MM □
- ㉝ PROPOSED AGGREGATE SHOULDERS, TYPE B, 280 MM
- ㉞ PROPOSED AGGREGATE SHOULDERS, TYPE B, 360 MM
- ㉟ PROPOSED CONCRETE BARRIER, SINGLE FACE, 1065 HEIGHT, REINFORCED
- ㊱ PROPOSED CONCRETE BARRIER, DOUBLE FACE, 815 HEIGHT
- ㊲ PROPOSED CONCRETE BARRIER, DOUBLE FACE, 1065 HEIGHT
- ㊳ PROPOSED CONCRETE BARRIER BASE
- ㊴ PROPOSED STEEL PLATE BEAM GUARDRAIL
- ㊵ PROPOSED PORTLAND CEMENT CONCRETE STABILIZATION 150 MM AT STEEL PLATE BEAM GUARDRAIL
- ㊶ PAVEMENT TO SHOULDER (LONGITUDINAL JOINT) *20 TIE BAR (EPOXY COATED) DRILL & GROUT 600mm LONG @ 600mm C-C
- ㊷ PAVEMENT TO PAVEMENT (LONGITUDINAL SAWED JOINT) *20 TIE BAR (EPOXY COATED) 750mm LONG @ 750mm C-C
- OR
- PAVEMENT TO PAVEMENT (LONGITUDINAL CONSTRUCTION JOINT) *25 TIE BAR (EPOXY COATED) DRILL & GROUT 600mm LONG @ 600mm C-C
- ㊸ TEMPORARY CONCRETE BARRIER REMOVAL
- ㊹ PROPOSED DITCH
- ㊺ BARRIER BASE OPEN JOINT (PJF)

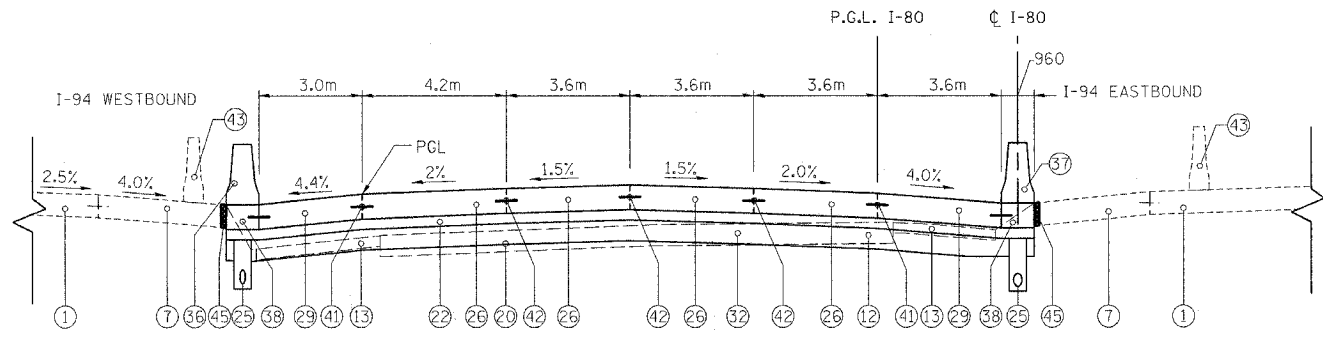

PROPOSED TYPICAL SECTION
STA. 4+095.530 TO STA. 4+500.000 C I-80 (WB)

NOTES

1. ALL DIMENSIONS ARE IN MILLIMETERS UNLESS OTHERWISE NOTED.
2. FOR EXACT LIMITS OF REMOVAL ITEMS SEE EXISTING PLANS.
3. FOR OFFSET AND ELEVATIONS FOR PROPOSED GRADING SEE PROPOSED CROSS SECTIONS.
4. TIE BARS WILL BE MEASURED ACCORDING TO ARTICLE 508.07.
5. OFFSET TO SLOPE BREAK AS SHOWN ON CROSS SECTIONS
6. SHOULDER CORE INFORMATION IS AVAILABLE FROM IDOT.
7. EXTENDED LIFE EMBANKMENT IS SHOWN WHERE APPLICABLE. □

"CRC REINFORCEMENT CHART ON STANDARD 421001 SHALL BE MODIFIED AS FOLLOWS:

PAVEMENT WIDTH	A	B	C	D
3.6m	26 SPACES (27 BARS) AT 132mm	90mm	75mm	660mm
4.2m	31 SPACES (32 BARS) AT 130mm	90mm	75mm	660mm
4.9m	35 SPACES (36 BARS) AT 135mm	95mm	85mm	660mm

THE REINFORCEMENT SHALL BE 115mm FROM THE TOP OF PAVEMENT

MIXTURE DESIGN TABLE

TS-5

REVISIONS		ILLINOIS DEPARTMENT OF TRANSPORTATION F.A.I. ROUTE 80/94 (INTERSTATE 80/294)
NAME	DATE	
		TYPICAL SECTIONS
		DRAWN BY: CTT CHECKED BY: RCH
		DATE: JULY 18, 2005
		McDonough Associates Inc. Engineers / Architects

F.A.I. RTE.	SECTION	COUNTY	TOTAL SHEETS	SHEET NO.
80/94	*	COOK	231	21
STA.	TO STA.			
FED. ROAD DIST. NO. 1	ILLINOIS	FED. AID PROJECT		
*(0203.1 & 0304) R-6		CONTRACT * 62105		

LEGEND

- ITEM TO BE CONSTRUCTED TO EXTENDED LIFE CONCRETE PAVEMENT SPECIFICATIONS
- ① EXISTING PAVEMENT
- ② EXISTING JOINTED CONCRETE PAVEMENT, 250 MM
- ③ EXISTING SHOULDER
- ④ EXISTING SELECTED SUBGRADE, 250 MM
- ⑤ EXISTING CONCRETE GUTTER, TYPE G-3
- ⑥ EXISTING PAVEMENT (150 MM BITUMINOUS OVERLAY, 275 MM CONCRETE)
- ⑦ EXISTING SHOULDER (SEE NOTE 6)
- ⑧ EXISTING GUARDRAIL
- ⑨ EXISTING CONCRETE BARRIER
- ⑩ EXISTING COMBINATION CURB AND GUTTER
- ⑪ EXISTING MECHANICALLY STABILIZED EARTH RETAINING WALL
- ⑫ PAVEMENT REMOVAL/PAVEMENT BREAKING, 425mm
- ⑬ PAVED SHOULDER REMOVAL, (SEE NOTE 6)
- ⑭ COMBINATION CURB AND GUTTER REMOVAL
- ⑮ GUARDRAIL REMOVAL
- ⑯ CONCRETE BARRIER & BASE REMOVAL
- ⑰ REMOVAL AND DISPOSAL OF UNSUITABLE MATERIAL
- ⑱ EARTH EXCAVATION
- ⑲ PROPOSED EMBANKMENT (SEE NOTE 7)
- ⑳ PROPOSED GEOTECHNICAL FABRIC FOR GROUND STABILIZATION □□
- ㉑ PROPOSED STABILIZED SUBBASE (BAM), 100 MM
- ㉒ PROPOSED STABILIZED SUBBASE, 150 MM □□
- ㉓ PROPOSED AGGREGATE SUBGRADE, 300 MM
- ㉔ NOT USED
- ㉕ PROPOSED PIPE UNDERDRAINS, 150 MM
- ㉖ PROPOSED CONTINUOUSLY REINFORCED PORTLAND CEMENT CONCRETE PAVEMENT, 360 MM □□
- ㉗ PROPOSED PORTLAND CEMENT CONCRETE PAVEMENT (JOINTED), 280MM
- ㉘ PROPOSED PORTLAND CEMENT CONCRETE SHOULDERS, 280 MM
- ㉙ PROPOSED PORTLAND CEMENT CONCRETE SHOULDERS, 360 MM □□
- ㉚ PROPOSED CONCRETE GUTTER, TYPE A (MODIFIED)
- ㉛ TOPSOIL FURNISH AND PLACE, 150 MM
- ㉜ PROPOSED SUBBASE GRANULAR MATERIAL, TYPE B, 300 MM □□
- ㉝ PROPOSED AGGREGATE SHOULDERS, TYPE B, 280 MM
- ㉞ PROPOSED AGGREGATE SHOULDERS, TYPE B, 360 MM
- ㉟ PROPOSED CONCRETE BARRIER, SINGLE FACE, 1065 HEIGHT, REINFORCED
- ㊱ PROPOSED CONCRETE BARRIER, DOUBLE FACE, 815 HEIGHT
- ㊲ PROPOSED CONCRETE BARRIER, DOUBLE FACE, 1065 HEIGHT
- ㊳ PROPOSED CONCRETE BARRIER BASE
- ㊴ PROPOSED STEEL PLATE BEAM GUARDRAIL
- ㊵ PROPOSED PORTLAND CEMENT CONCRETE STABILIZATION 150 MM AT STEEL PLATE BEAM GUARDRAIL
- ㊶ PAVEMENT TO SHOULDER (LONGITUDINAL JOINT) *20 TIE BAR (EPOXY COATED) DRILL & GROUT 600mm LONG @ 600mm C-C
- ㊷ PAVEMENT TO PAVEMENT (LONGITUDINAL SAWED JOINT) *20 TIE BAR (EPOXY COATED) 750mm LONG @ 750mm C-C
- OR
- PAVEMENT TO PAVEMENT (LONGITUDINAL CONSTRUCTION JOINT) *25 TIE BAR (EPOXY COATED) DRILL & GROUT 600mm LONG @ 600mm C-C
- ㊸ TEMPORARY CONCRETE BARRIER REMOVAL
- ㊹ PROPOSED DITCH
- ㊺ BARRIER BASE OPEN JOINT (PJF)

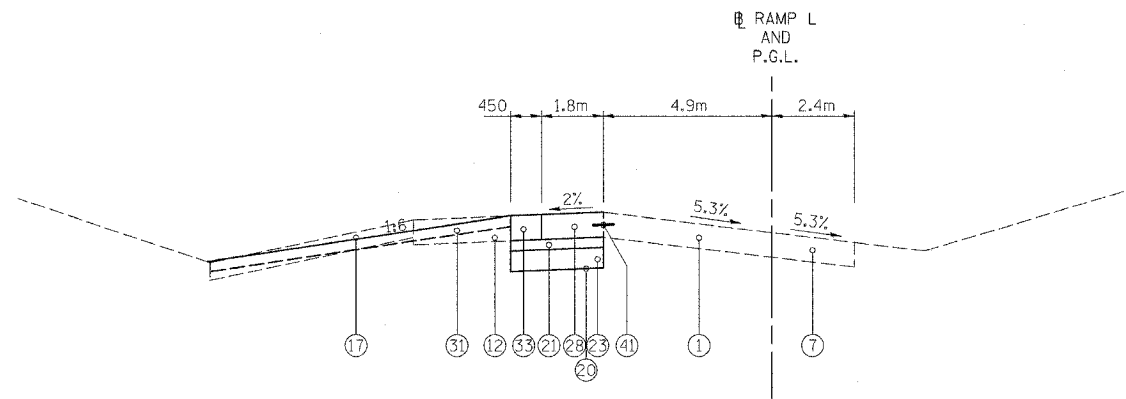

PROPOSED TYPICAL SECTION

STA. 160+205.492 TO STA. 160+325.300 RAMP L

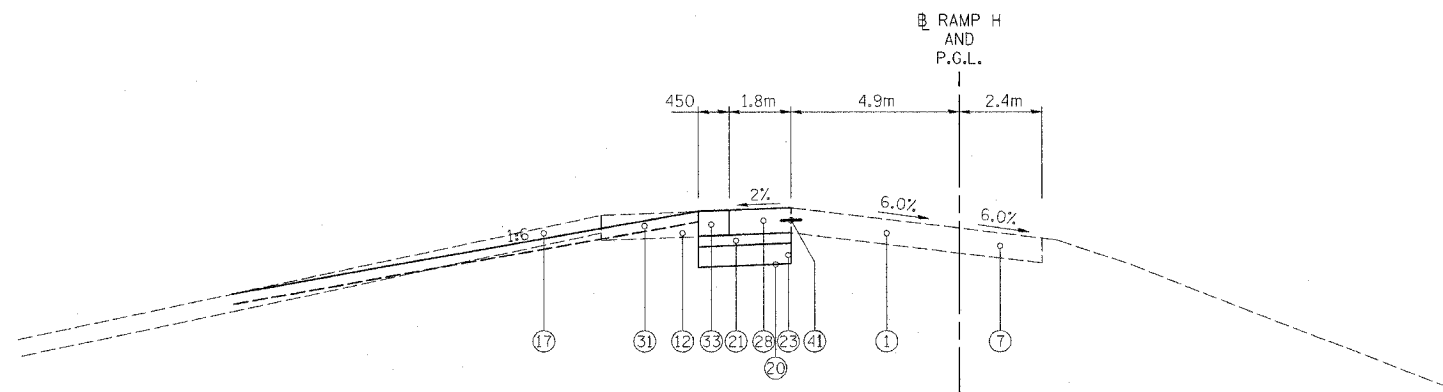

PROPOSED TYPICAL SECTION

STA. 130+750.000 TO STA. 130+882.000 RAMP H

NOTES

1. ALL DIMENSIONS ARE IN MILLIMETERS UNLESS OTHERWISE NOTED.
2. FOR EXACT LIMITS OF REMOVAL ITEMS SEE EXISTING PLANS.
3. FOR OFFSET AND ELEVATIONS FOR PROPOSED GRADING SEE PROPOSED CROSS SECTIONS.
4. TIE BARS WILL BE MEASURED ACCORDING TO ARTICLE 508.07.
5. OFFSET TO SLOPE BREAK AS SHOWN ON CROSS SECTIONS
6. SHOULDER CORE INFORMATION IS AVAILABLE FROM IDOT.
7. EXTENDED LIFE EMBANKMENT IS SHOWN WHERE APPLICABLE. □□

"CRC REINFORCEMENT CHART ON STANDARD 421001 SHALL BE MODIFIED AS FOLLOWS:

PAVEMENT WIDTH	A	B	C	D
3.6m	26 SPACES (27 BARS) AT 132mm	90mm	75mm	660mm
4.2m	31 SPACES (32 BARS) AT 130mm	90mm	75mm	660mm
4.9m	35 SPACES (36 BARS) AT 135mm	95mm	85mm	660mm

THE REINFORCEMENT SHALL BE 115mm FROM THE TOP OF PAVEMENT

MIXTURE DESIGN TABLE

TS-6

REVISIONS		ILLINOIS DEPARTMENT OF TRANSPORTATION F.A.I. ROUTE 80/94 (INTERSTATE 80/294)
NAME	DATE	
		TYPICAL SECTIONS
		DATE: JULY 18, 2005
		DRAWN BY: CTT CHECKED BY: RCH
		McDonough Associates Inc. Engineers / Architects

F.A.I. RTE.	SECTION	COUNTY	TOTAL SHEETS	SHEET NO.
80/94	*	COOK	231	22
STA.	TO STA.			
FED. ROAD DIST. NO. 1	ILLINOIS	FED. AID PROJECT		
*(0203.1 & 0304) R-6			CONTRACT # 62105	

LEGEND

- ① PROPOSED PAVEMENT
- ② PORTLAND CEMENT CONCRETE SHOULDERS
- ③ STABILIZED SUBBASE - 150 mm
- ④ SUB-BASE GRANULAR MATERIAL, TYPE B - 300 mm
- ⑤ GEOTECHNICAL FABRIC FOR GROUND STABILIZATION
- ⑥ NOT USED
- ⑦ CONCRETE BARRIER, SINGLE FACE
- ⑧ CONCRETE BARRIER, DOUBLE FACE
- ⑨ CONCRETE BARRIER BASE
- ⑩ BARRIER BASE OPEN JOINT (PJF)
- ⑪ PIPE UNDERDRAINS - 150 mm
- ⑫ RETAINING WALL
- ⑬ GEOCOMPOSITE WALL DRAIN
- ⑭ CONCRETE HEADWALLS FOR PIPE DRAINS (STD. 601101)
- ⑮ PIPE UNDERDRAINS (SPECIAL)
- ⑯ AGGREGATE SHOULDERS, TYPE B

LEGEND

(COST INCLUDED IN PIPE UNDERDRAINS)

- ①A FABRIC ENVELOPE FOR PIPE UNDERDRAINS
- ②A POROUS GRANULAR BACKFILL (CA-16)

- NOTE 1: NO ADDITIONAL COMPENSATION WILL BE ALLOWED FOR TRENCHING THROUGH AGGREGATE SUBGRADE, POROUS GRANULAR EMBANKMENT, SUBGRADE OR GEOTECHNICAL FABRIC FOR GROUND STABILIZATION.
- NOTE 2: DRAINAGE MATS WILL NOT BE ALLOWED.
- NOTE 3: SEE TYPICAL SECTIONS AND ROADWAY PLANS FOR PAVEMENT AND SHOULDER TYPES, WIDTHS AND CROSS-SLOPES.
- NOTE 4: SEE CONCRETE BARRIER DETAILS FOR REQUIRED TIE BARS OR REINFORCING BARS AND OTHER DETAILS.
- NOTE 5: ADDITIONAL SUB-BASE GRANULAR MATERIAL UNDER THE CONCRETE BARRIER WILL NOT BE PAID FOR SEPARATELY BUT WILL BE INCLUDED IN THE SQUARE METER COST OF SUB-BASE GRANULAR MATERIAL, TYPE B.
- NOTE 6: ALL PIPE FITTINGS NECESSARY FOR THE INSTALLATION OF THE UNDERDRAIN SYSTEM WILL NOT BE PAID FOR SEPARATELY BUT WILL BE INCLUDED IN THE METER COST OF PIPE UNDERDRAINS, 150.

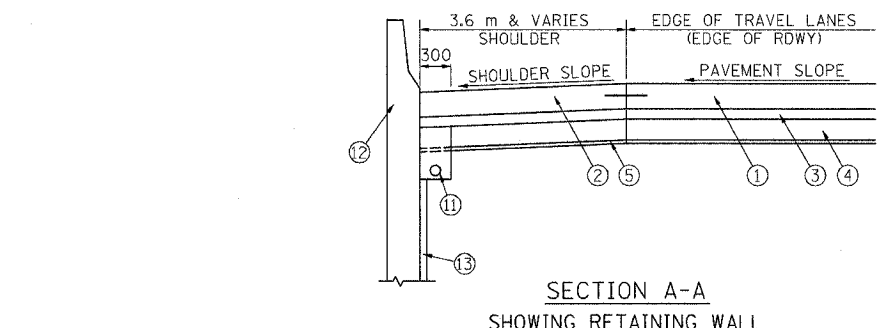

SECTION A-A
SHOWING RETAINING WALL

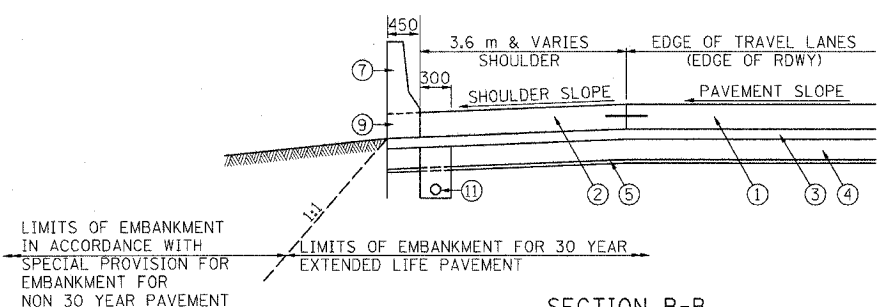

SECTION B-B
SHOWING CONCRETE BARRIER, SINGLE FACE

LIMITS OF EMBANKMENT IN ACCORDANCE WITH SPECIAL PROVISION FOR EMBANKMENT FOR NON 30 YEAR PAVEMENT

LIMITS OF EMBANKMENT FOR 30 YEAR EXTENDED LIFE PAVEMENT

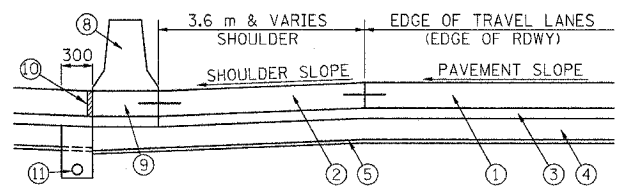

SECTION C-C
SHOWING CONCRETE BARRIER, DOUBLE FACE

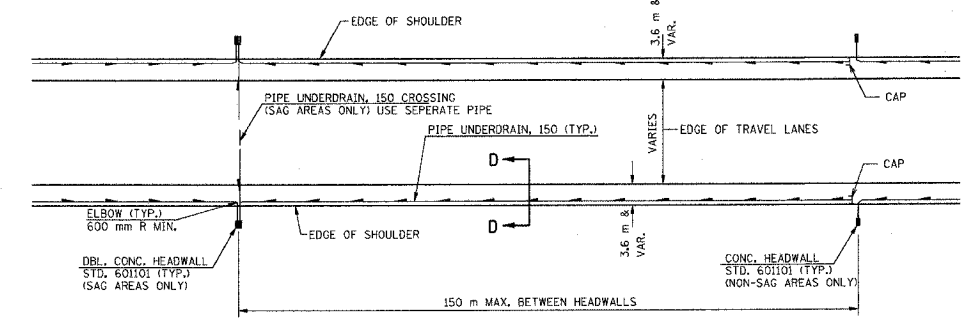

PROPOSED PLAN VIEW WITH OPEN DRAINAGE SYSTEM

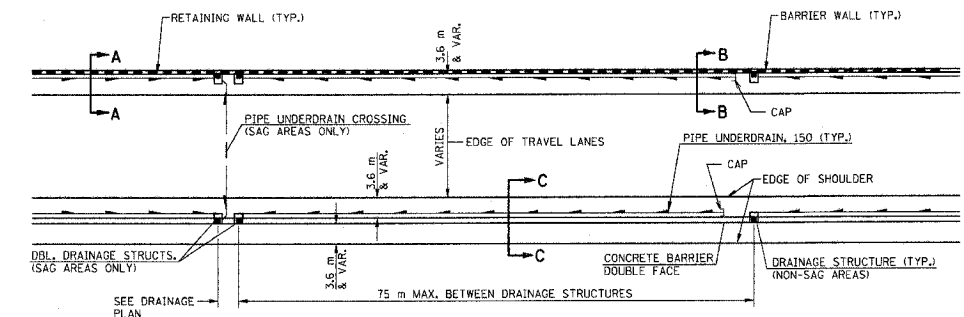

PROPOSED PLAN VIEW WITH CLOSED DRAINAGE SYSTEM

LIMITS OF EMBANKMENT IN ACCORDANCE WITH SPECIAL PROVISION FOR EMBANKMENT FOR NON 30 YEAR PAVEMENT

LIMITS OF EMBANKMENT FOR 30 YEAR EXTENDED LIFE PAVEMENT

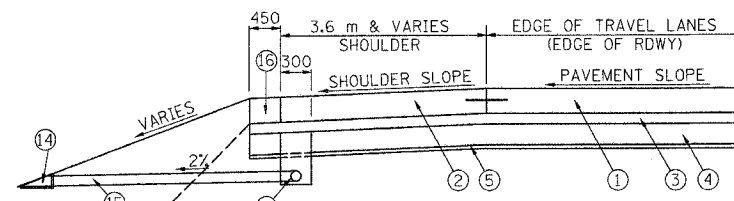

SECTION D-D
SHOWING OPEN DRAINAGE

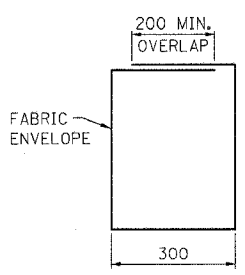

FABRIC ENVELOPE
DETAIL

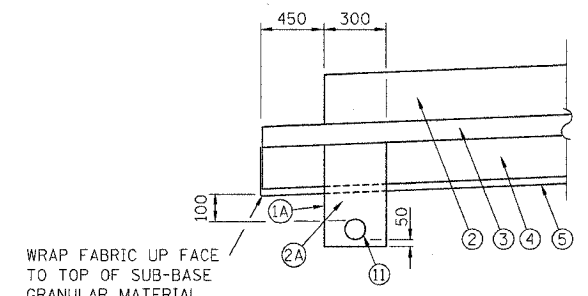

UNDERDRAIN TRENCH
DETAIL

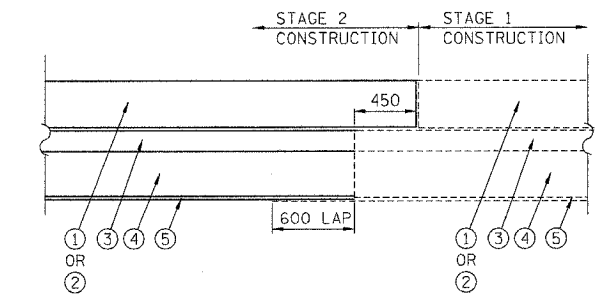

DETAIL FOR STAGE CONSTRUCTION OF THE SUBGRADE
(FOR 30 YEAR EXTENDED LIFE PAVEMENT)

LEGEND

- STAGE 1
- STAGE 2

REVISIONS	
NAME	DATE
ACE	06/04
ACE	6/9/04
ACE	4/20/05

ALL DIMENSIONS IN MILLIMETERS **TS-7**
UNLESS OTHERWISE SHOWN.

ILLINOIS DEPARTMENT OF TRANSPORTATION
F.A.I. ROUTE 80/94 (KINGERY EXPRESSWAY)

**PIPE UNDERDRAIN AND SUBGRADE DETAILS
FOR OPEN AND CLOSED DRAINAGE SYSTEMS**

SCALE NONE
DATE 02/04

DRAWN BY ACE/CAD
CHECKED BY

AMERICAN
CONSULTING ENGINEERS

F.A.I. RTE.	SECTION	COUNTY	TOTAL SHEETS	SHEET NO.
80/94	*	COOK	231	23
STA.		TO STA.		
FED. ROAD DIST. NO. 1		ILLINOIS FED. AID PROJECT		
*(0203.1 & 0304) R-6		CONTRACT # 62105		

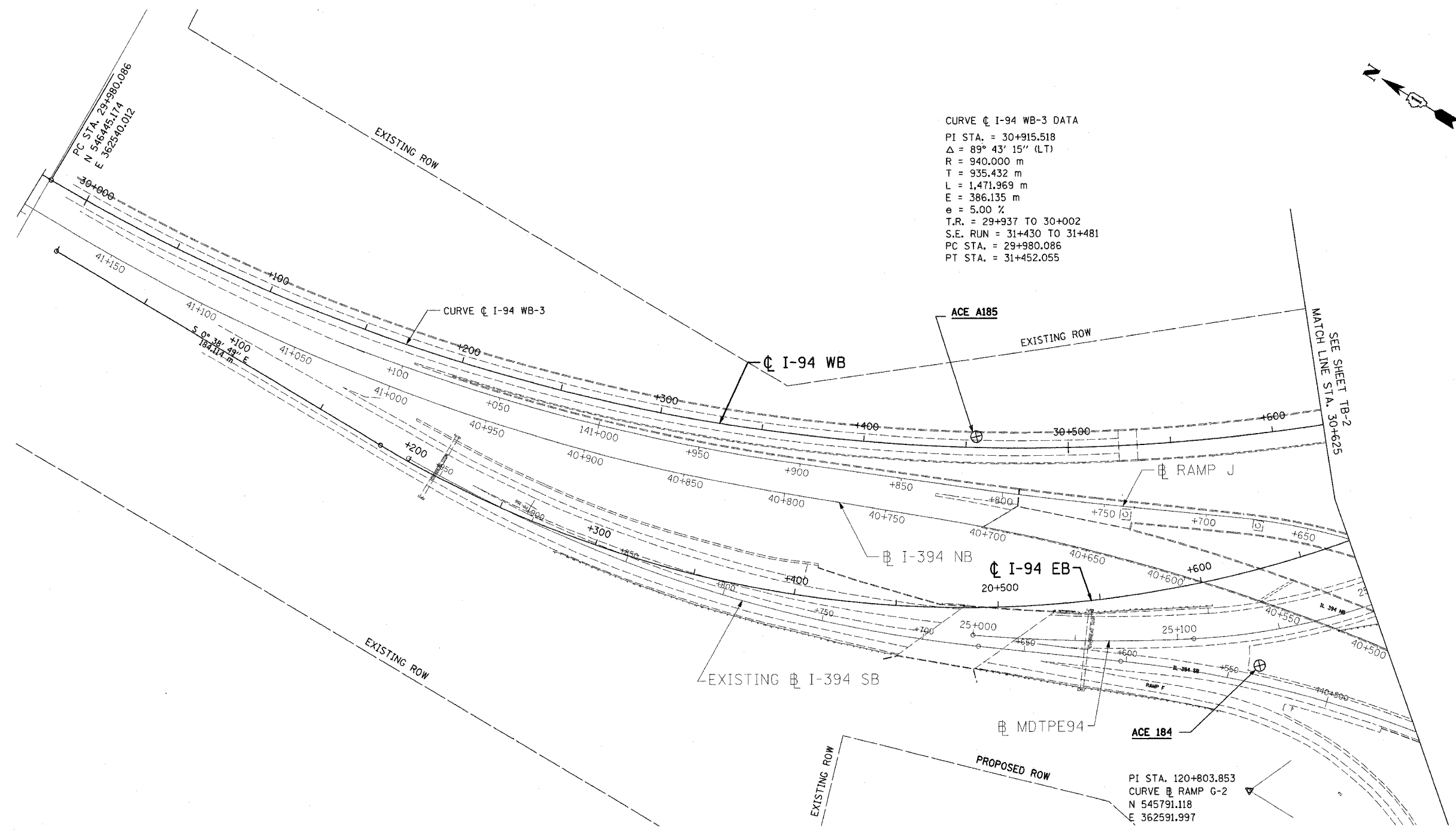

CURVE C I-94 WB-3 DATA
 PI STA. = 30+915.518
 $\Delta = 89^\circ 43' 15''$ (LT)
 R = 940.000 m
 T = 935.432 m
 L = 1,471.969 m
 E = 386.135 m
 e = 5.00 %
 T.R. = 29+937 TO 30+002
 S.E. RUN = 31+430 TO 31+481
 PC STA. = 29+980.086
 PT STA. = 31+452.055

PI STA. 120+803.853
 CURVE B RAMP G-2
 N 545791.118
 E 362591.997

NOTE: FOR ALIGNMENT TIES SEE DRAWINGS TB-6 AND TB-7
 FOR BENCHMARKS SEE DRAWING TB-7.

TB-1

REVISIONS		ILLINOIS DEPARTMENT OF TRANSPORTATION F.A.I. ROUTE 80/94 (INTERSTATE 80/294)
NAME	DATE	
		ALIGNMENT, TIES, AND BENCHMARKS
SCALE: 1:1000		DRAWN BY: CTT
DATE: JULY 18, 2005		CHECKED BY: RCH
 McDonough Associates Inc. <small>Engineers / Architects</small>		

F.A.I. RTE.	SECTION	COUNTY	TOTAL SHEETS	SHEET NO.
80/94	*	COOK	231	24
STA.	TO STA.			
FED. ROAD DIST. NO. 1	ILLINOIS FED. AID PROJECT			
*0203.1 & 0304 R-6			CONTRACT # 62105	

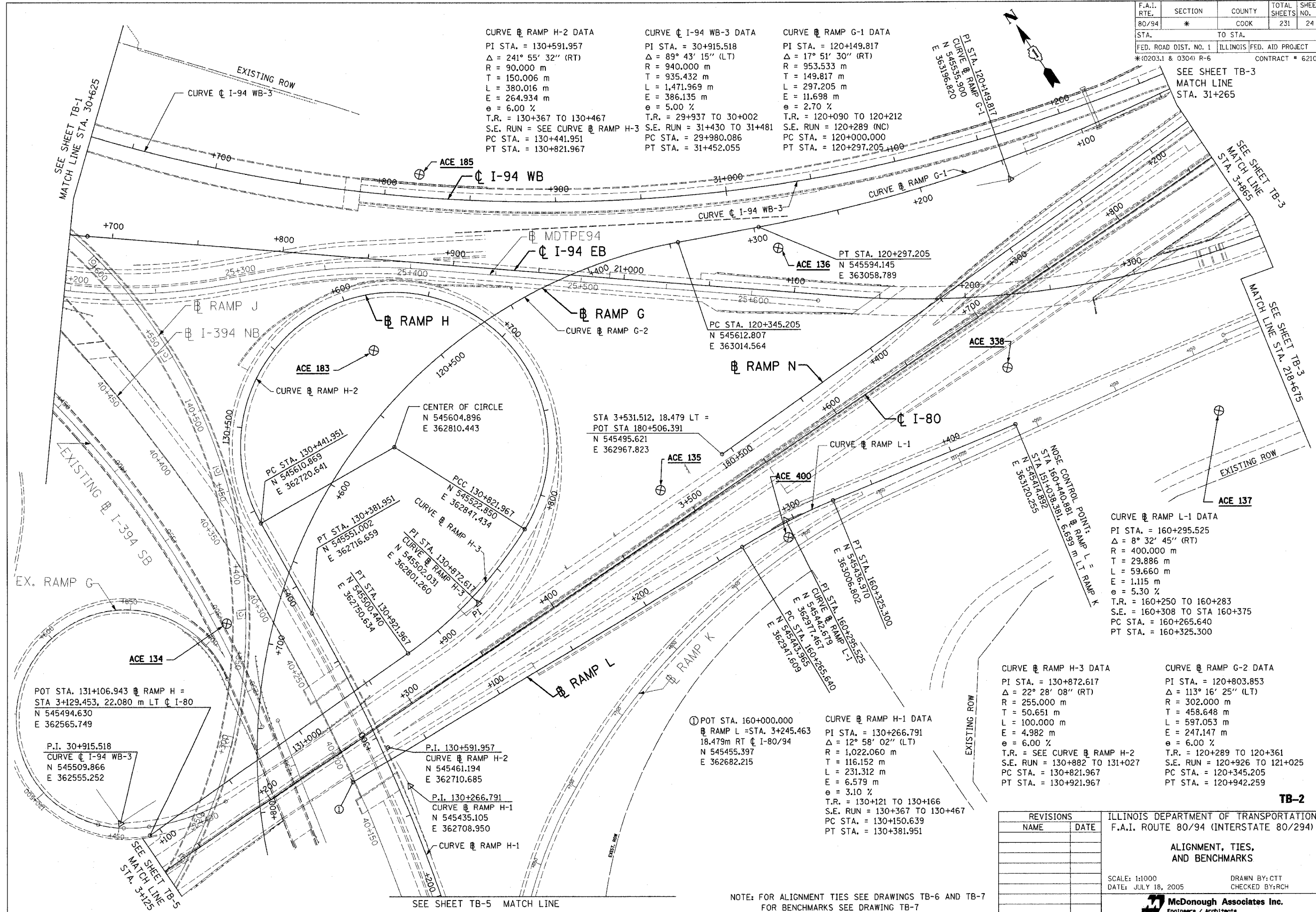

CURVE @ RAMP H-2 DATA
 PI STA. = 130+591.957
 $\Delta = 241^\circ 55' 32''$ (RT)
 R = 90.000 m
 T = 150.006 m
 L = 380.016 m
 E = 264.934 m
 $e = 6.00\%$
 T.R. = 130+367 TO 130+467
 S.E. RUN = SEE CURVE @ RAMP H-3
 PC STA. = 130+441.951
 PT STA. = 130+821.967

CURVE @ I-94 WB-3 DATA
 PI STA. = 30+915.518
 $\Delta = 89^\circ 43' 15''$ (LT)
 R = 940.000 m
 T = 935.432 m
 L = 1,471.969 m
 E = 386.135 m
 $e = 5.00\%$
 T.R. = 29+937 TO 30+002
 S.E. RUN = 31+430 TO 31+481
 PC STA. = 29+980.086
 PT STA. = 31+452.055

CURVE @ RAMP G-1 DATA
 PI STA. = 120+149.817
 $\Delta = 17^\circ 51' 30''$ (RT)
 R = 953.533 m
 T = 149.817 m
 L = 297.205 m
 E = 11.698 m
 $e = 2.70\%$
 T.R. = 120+090 TO 120+212
 S.E. RUN = 120+289 (NC)
 PC STA. = 120+000.000
 PT STA. = 120+297.205

CURVE @ RAMP L-1 DATA
 PI STA. = 160+295.525
 $\Delta = 8^\circ 32' 45''$ (RT)
 R = 400.000 m
 T = 29.886 m
 L = 59.660 m
 E = 1.115 m
 $e = 5.30\%$
 T.R. = 160+250 TO 160+283
 S.E. = 160+308 TO STA 160+375
 PC STA. = 160+265.640
 PT STA. = 160+325.300

CURVE @ RAMP H-3 DATA
 PI STA. = 130+872.617
 $\Delta = 22^\circ 28' 08''$ (RT)
 R = 255.000 m
 T = 50.651 m
 L = 100.000 m
 E = 4.982 m
 $e = 6.00\%$
 T.R. = SEE CURVE @ RAMP H-2
 S.E. RUN = 130+882 TO 131+027
 PC STA. = 130+821.967
 PT STA. = 130+921.967

CURVE @ RAMP G-2 DATA
 PI STA. = 120+803.853
 $\Delta = 113^\circ 16' 25''$ (LT)
 R = 302.000 m
 T = 458.648 m
 L = 597.053 m
 E = 247.147 m
 $e = 6.00\%$
 T.R. = 120+289 TO 120+361
 S.E. RUN = 120+926 TO 121+025
 PC STA. = 120+345.205
 PT STA. = 120+942.259

CURVE @ RAMP H-1 DATA
 PI STA. = 130+266.791
 $\Delta = 12^\circ 58' 02''$ (LT)
 R = 1,022.060 m
 T = 116.152 m
 L = 231.312 m
 E = 6.579 m
 $e = 3.10\%$
 T.R. = 130+121 TO 130+166
 S.E. RUN = 130+367 TO 130+467
 PC STA. = 130+150.639
 PT STA. = 130+381.951

POT STA. 131+106.943 @ RAMP H =
 STA 3+129.453, 22.080 m LT @ I-80
 N 545494.630
 E 362565.749

P.I. 30+915.518
 CURVE @ I-94 WB-3
 N 545509.866
 E 362555.252

P.I. 130+591.957
 CURVE @ RAMP H-2
 N 545461.194
 E 362710.685

P.I. 130+266.791
 CURVE @ RAMP H-1
 N 545435.105
 E 362708.950

REVISIONS	
NAME	DATE

ILLINOIS DEPARTMENT OF TRANSPORTATION
 F.A.I. ROUTE 80/94 (INTERSTATE 80/294)

ALIGNMENT, TIES,
 AND BENCHMARKS

SCALE: 1:1000
 DATE: JULY 18, 2005
 DRAWN BY: CTT
 CHECKED BY: RCH



NOTE: FOR ALIGNMENT TIES SEE DRAWINGS TB-6 AND TB-7
 FOR BENCHMARKS SEE DRAWING TB-7

TB-2

F.A.I. RTE.	SECTION	COUNTY	TOTAL SHEETS	SHEET NO.
80/94	*	COOK	231	25
STA.		TO STA.		
FED. ROAD DIST. NO. 1		ILLINOIS	FED. AID PROJECT	
*(0203.1 & 0304) R-6		CONTRACT # 62105		

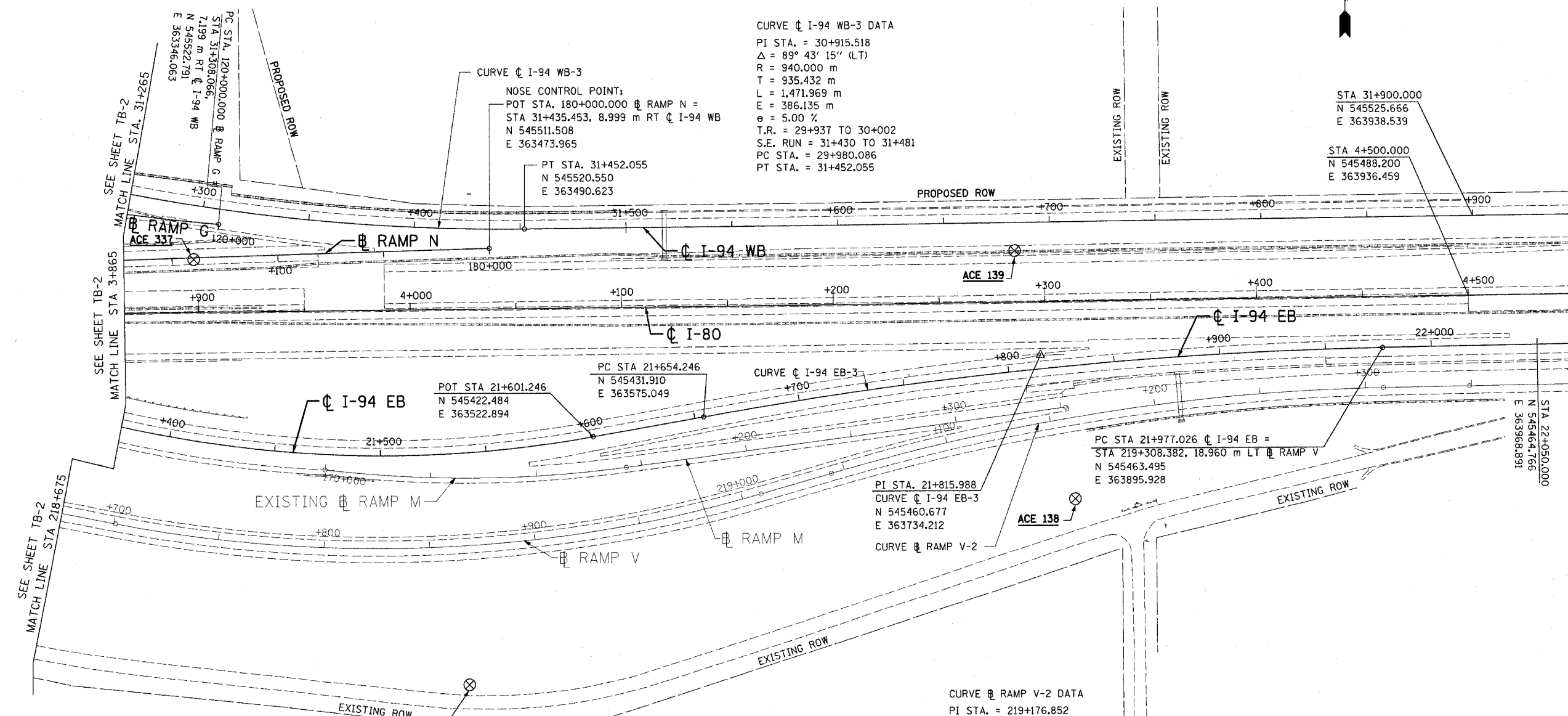

CURVE I-94 WB-3 DATA
 PI STA. = 30+915.518
 $\Delta = 89^\circ 43' 15''$ (LT)
 R = 940.000 m
 T = 935.432 m
 L = 1,471.969 m
 E = 386.135 m
 e = 5.00 %
 T.R. = 29+937 TO 30+002
 S.E. RUN = 31+430 TO 31+481
 PC STA. = 29+980.086
 PT STA. = 31+452.055

CURVE I-94 WB-3
 NOSE CONTROL POINT:
 POT STA. 180+000.000 RAMP N =
 STA 31+435.453, 8.999 m RT I-94 WB
 N 545511.508
 E 363473.965

PT STA. 31+452.055
 N 545520.550
 E 363490.623

POT STA 21+601.246
 N 545422.484
 E 363522.894

PC STA 21+654.246
 N 545431.910
 E 363575.049

PC STA 21+977.026 I-94 EB =
 STA 219+308.382, 18.960 m LT RAMP V
 N 545463.495
 E 363895.928

PI STA. 21+815.988
 CURVE I-94 EB-3
 N 545460.677
 E 363734.212

CURVE RAMP V-2 DATA
 PI STA. = 219+176.852
 $\Delta = 15^\circ 09' 41''$ (RT)
 R = 1,000.000 m
 T = 133.086 m
 L = 264.617 m
 E = 8.817 m
 e = 3.10 %
 T.R. = 218+999 TO 219+051
 S.E. RUN = 219+289 TO 219+369
 PC STA. = 219+043.766
 PT STA. = 219+308.382

CURVE I-94 EB-3 DATA
 PI STA. = 21+815.988
 $\Delta = 9^\circ 14' 49''$ (RT)
 R = 2,000.000 m
 T = 161.741 m
 L = 322.780 m
 E = 6.529 m
 e = 6.00 %
 T.R. =
 S.E. RUN =
 PC STA. = 21+654.246
 PT STA. = 21+977.026

TB-3

REVISIONS	
NAME	DATE

ILLINOIS DEPARTMENT OF TRANSPORTATION
 F.A.I. ROUTE 80/94 (INTERSTATE 80/294)

ALIGNMENT, TIES,
 AND BENCHMARKS

SCALE: 1:1000
 DATE: JULY 18, 2005

DRAWN BY: CTT
 CHECKED BY: RCH

McDonough Associates Inc.
 Engineers / Architects

NOTE: FOR ALIGNMENT TIES SEE DRAWINGS TB-6 AND TB-7
 FOR BENCHMARKS SEE DRAWING TB-7

F.A.I. RTE.	SECTION	COUNTY	TOTAL SHEETS	SHEET NO.
80/94	*	COOK	231	26
STA.		TO STA.		
FED. ROAD DIST. NO. 1		ILLINOIS FED. AID PROJECT		
*10203.1 & 03041 R-6		CONTRACT # 62105		

CURVE CL80-2 DATA
 PI STA = 2+398.439 (23+70.73)
 $\Delta = 10^{\circ} 42' 23''$ (LT)
 T = 164.176 (538.64)
 L = 327.396 (1074.13)
 R = 1,752.092 (5748.33)
 E = 7.675 (25.18)
 D = (0° 59' 48")
 P.C. STA = 2+234.263 (29+06.23)
 P.T. STA = 2+561.659 (18+32.09)
 DESIGN SPEED = 95 KPH (60 MPH)
 S.E. = 2.0% (EXISTING)

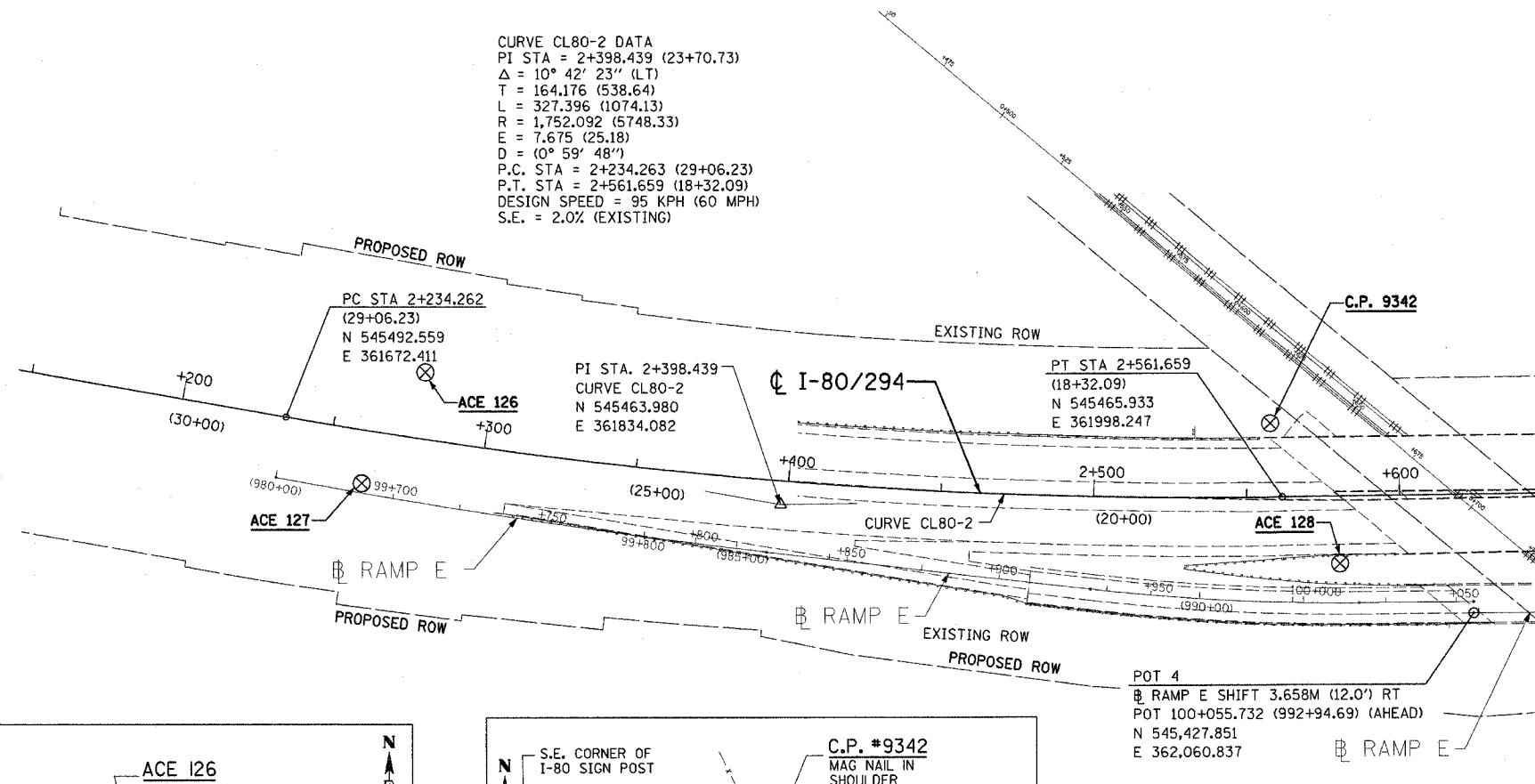

SEE SHEET TB-5 MATCH LINE STA. 2+650

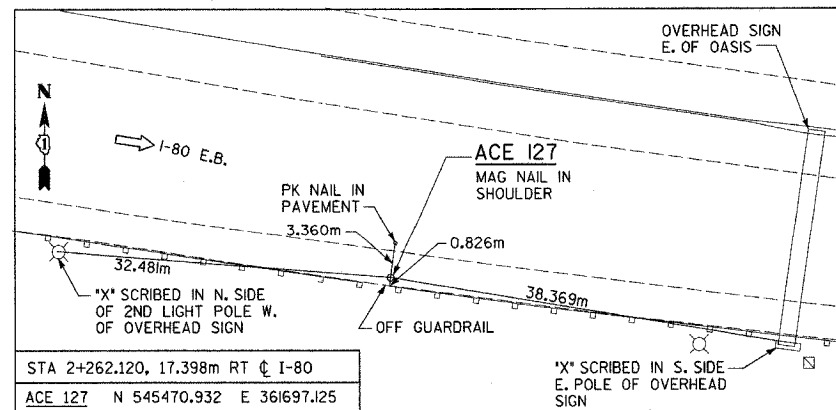
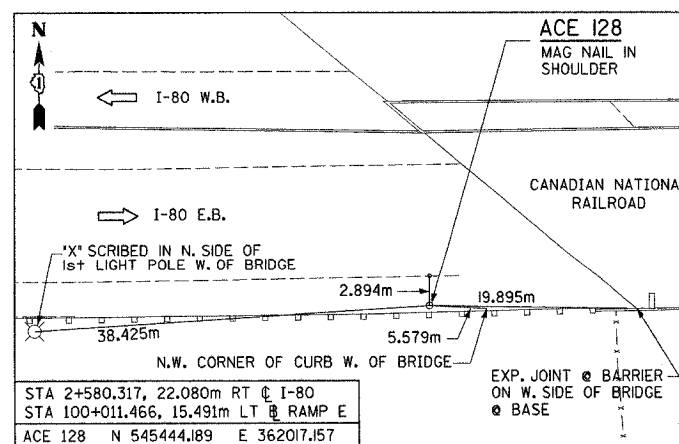
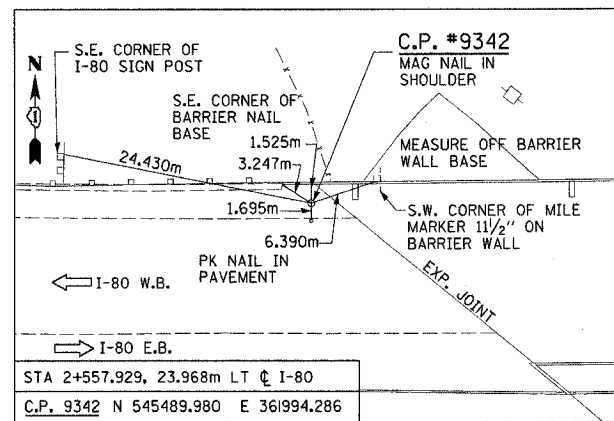
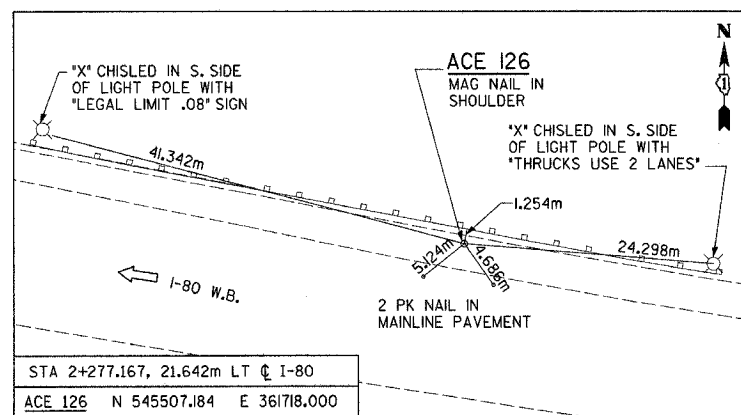

- NOTES:
- FOR BENCHMARKS SEE DRAWING TB-7
 - MONUMENTS, BENCHMARKS AND TIE POINTS MAY HAVE BEEN REMOVED AND RELOCATED UNDER PREVIOUS CONTRACTS. COORDINATE MONUMENTS AND TIE POINTS WITH RESIDENT ENGINEER.

REVISIONS	
NAME	DATE

ILLINOIS DEPARTMENT OF TRANSPORTATION
 F.A.I. ROUTE 80/94 (INTERSTATE 80/294)

ALIGNMENT, TIES,
 AND BENCHMARKS

SCALE: 1:1000
 DATE: JULY 18, 2005

DRAWN BY: CTT
 CHECKED BY: RCH

McDonough Associates Inc.
 Engineers / Architects

TB-4

F.A.I. RTE.	SECTION	COUNTY	TOTAL SHEETS	SHEET NO.
80/94	*	COOK	231	27
STA.		TO STA.		
FED. ROAD DIST. NO. 1		ILLINOIS FED. AID PROJECT		
*(0203.1 & 0304) R-6		CONTRACT # 62105		

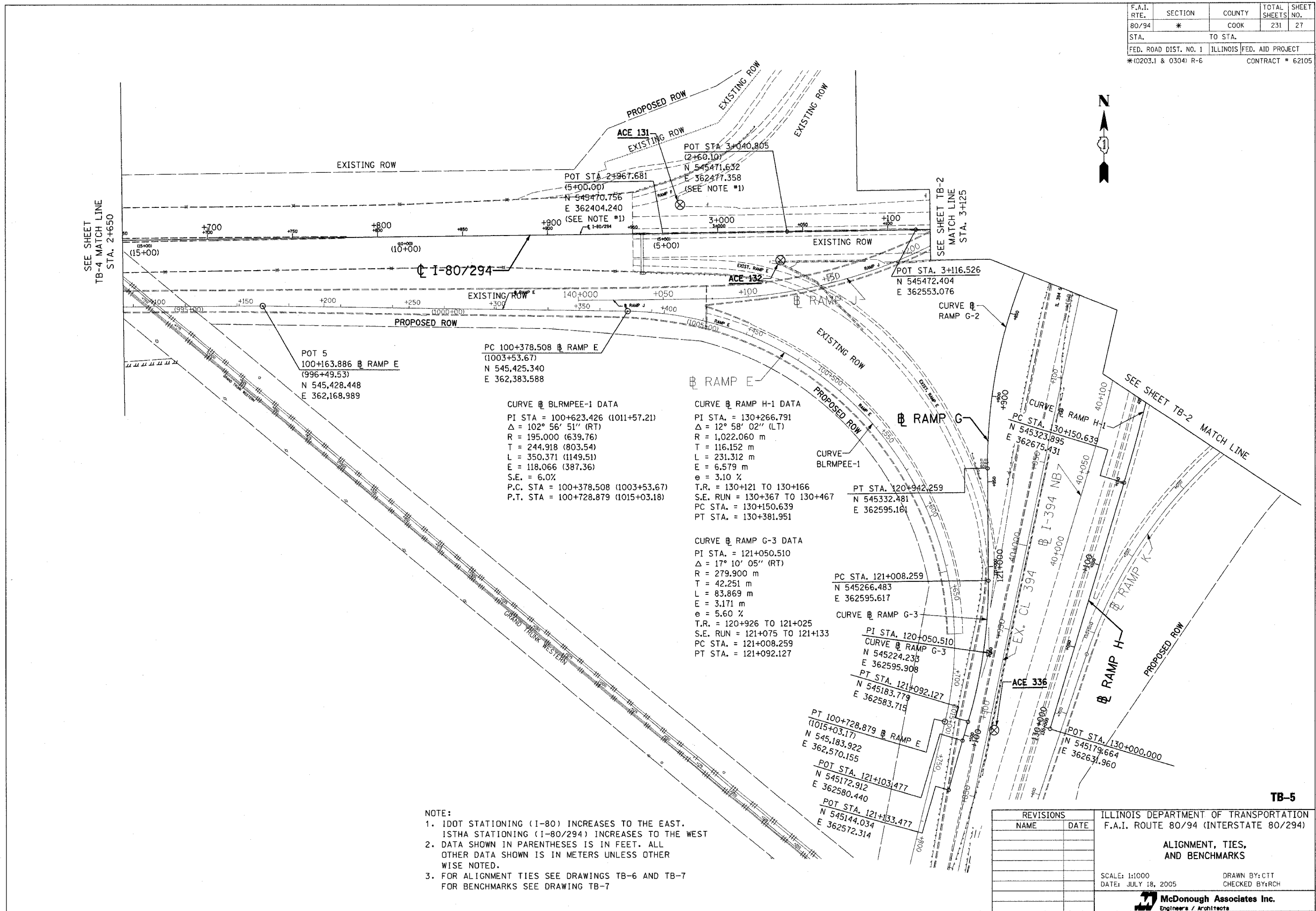

- NOTE:
1. IDOT STATIONING (I-80) INCREASES TO THE EAST. ISTHA STATIONING (I-80/294) INCREASES TO THE WEST
 2. DATA SHOWN IN PARENTHESES IS IN FEET. ALL OTHER DATA SHOWN IS IN METERS UNLESS OTHERWISE NOTED.
 3. FOR ALIGNMENT TIES SEE DRAWINGS TB-6 AND TB-7 FOR BENCHMARKS SEE DRAWING TB-7

REVISIONS		ILLINOIS DEPARTMENT OF TRANSPORTATION F.A.I. ROUTE 80/94 (INTERSTATE 80/294)
NAME	DATE	
		ALIGNMENT, TIES, AND BENCHMARKS
		SCALE: 1:1000
		DATE: JULY 18, 2005
		DRAWN BY: CTT
		CHECKED BY: RCH
		McDonough Associates Inc. Engineers / Architects

TB-5

F.A.I. RTE.	SECTION	COUNTY	TOTAL SHEETS	SHEET NO.
80/94	*	COOK	231	28
STA.		TO STA.		
FED. ROAD DIST. NO. 1		ILLINOIS FED. AID PROJECT		
*(0203.1 & 0304) R-6		CONTRACT # 62105		

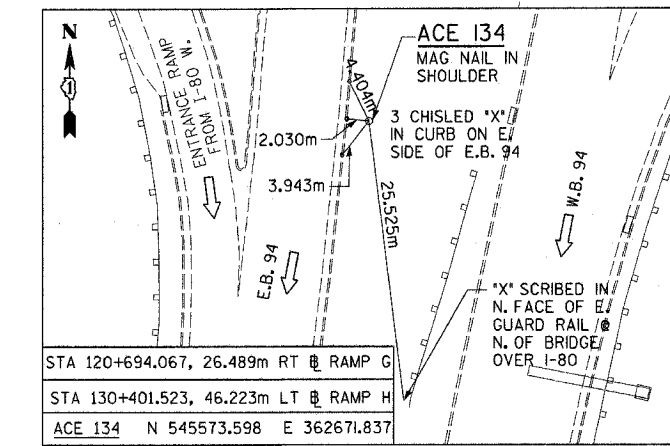
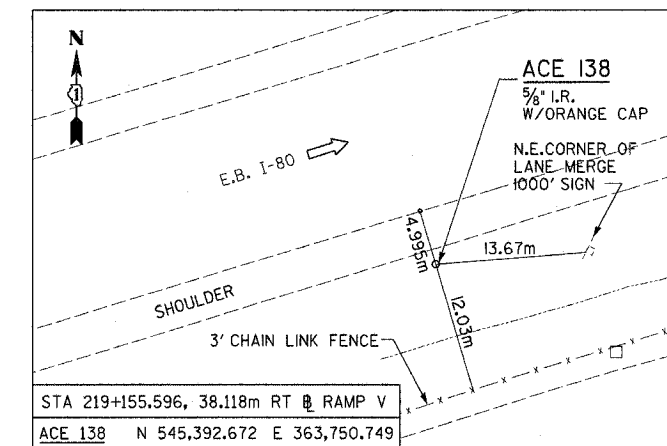
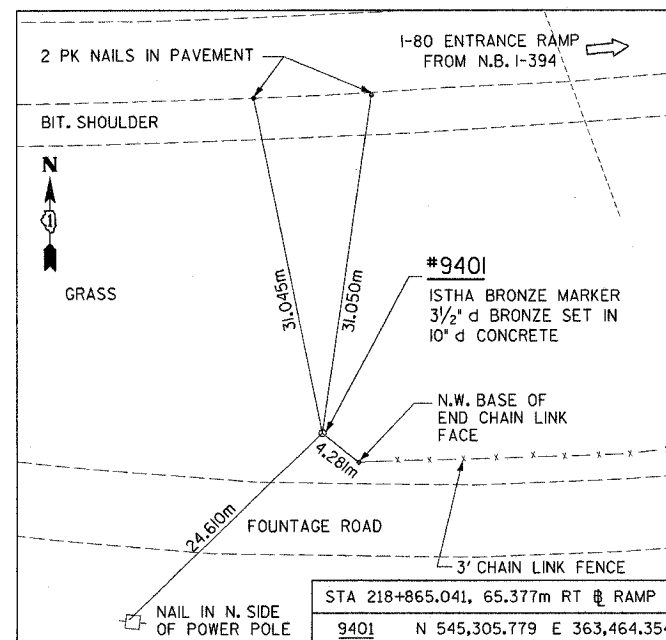
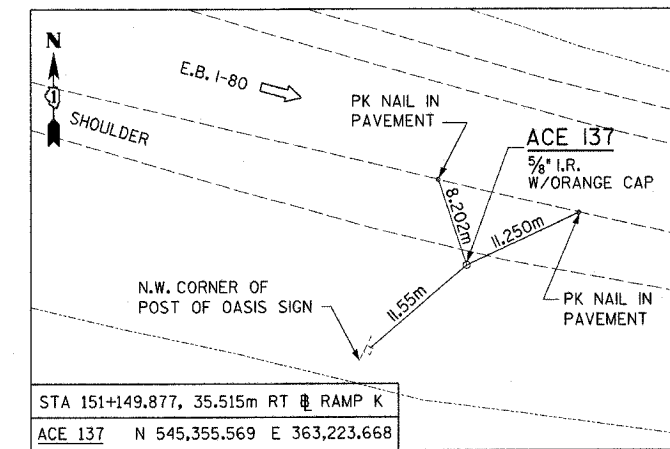
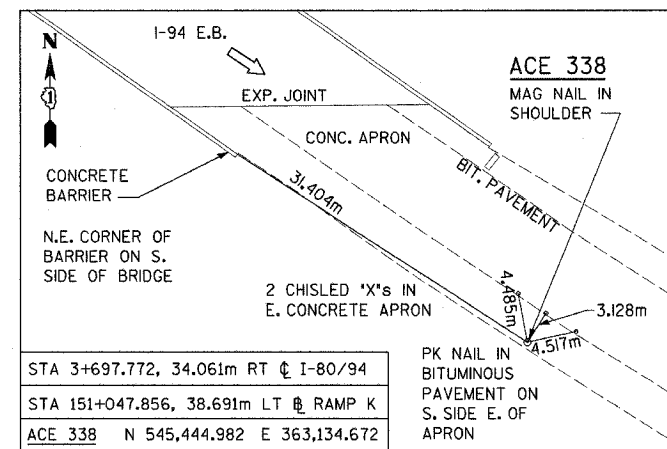
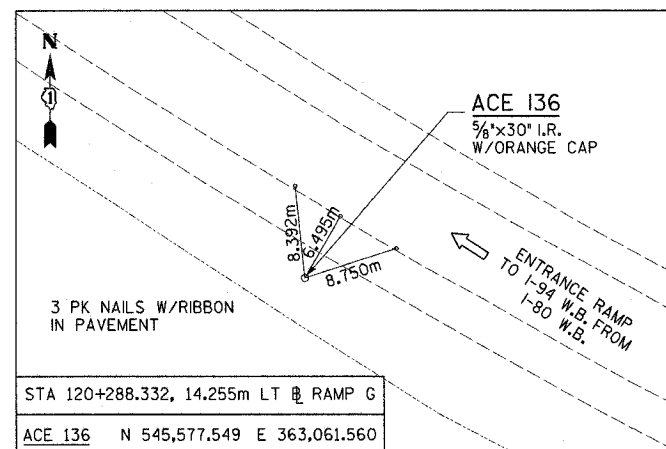
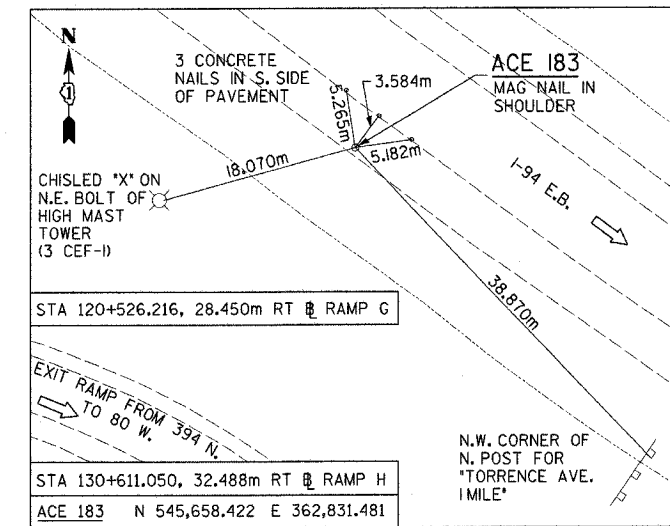
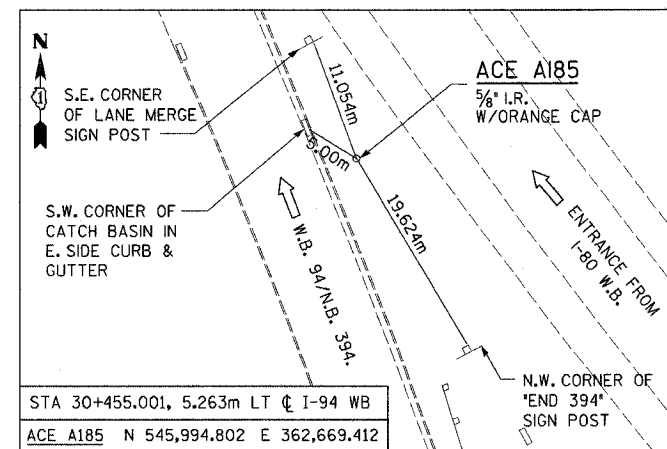
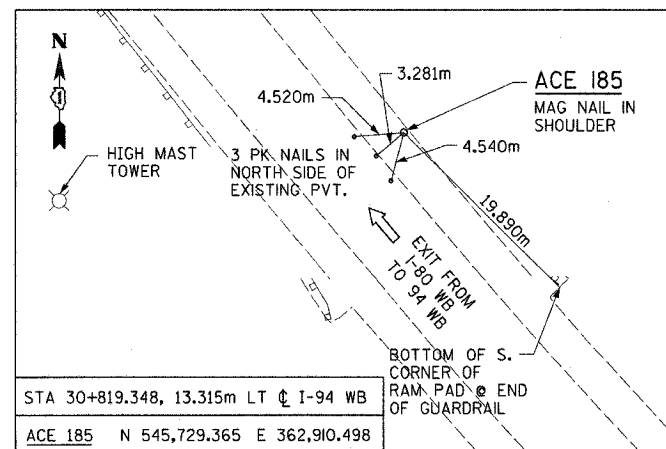

NOTES:

- FOR BENCHMARKS SEE DRAWING TB-7
- MONUMENTS, BENCHMARKS AND TIE POINTS MAY HAVE BEEN REMOVED AND RELOCATED UNDER PREVIOUS CONTRACTS. COORDINATE MONUMENTS AND TIE POINTS WITH RESIDENT ENGINEER.

REVISIONS	
NAME	DATE

ILLINOIS DEPARTMENT OF TRANSPORTATION
F.A.I. ROUTE 80/94 (INTERSTATE 80/294)

ALIGNMENT, TIES,
AND BENCHMARKS

SCALE: NONE
DATE: JULY 18, 2005
DRAWN BY: CTT
CHECKED BY: RCH

McDonough Associates Inc.
Engineers / Architects

TB-6

F.A.I. RTE.	SECTION	COUNTY	TOTAL SHEETS	SHEET NO.
80/94	*	COOK	231	29
STA.		TO STA.		
FED. ROAD DIST. NO. 1		ILLINOIS	FED. AID PROJECT	
* (0203.1 & 0304) R-6			CONTRACT # 62105	

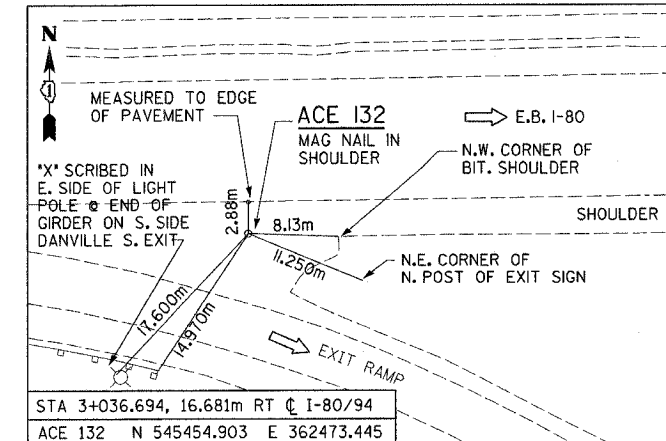
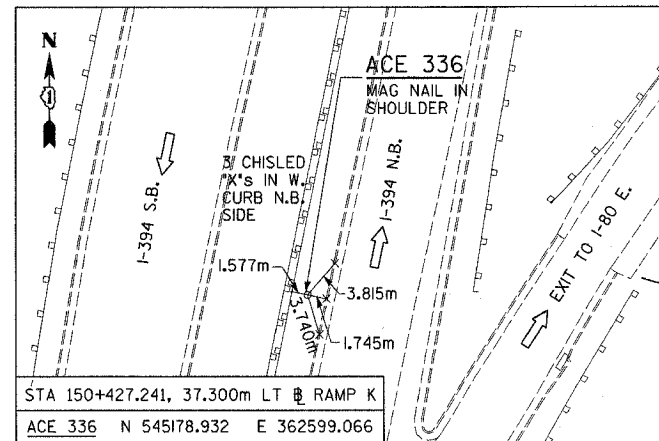
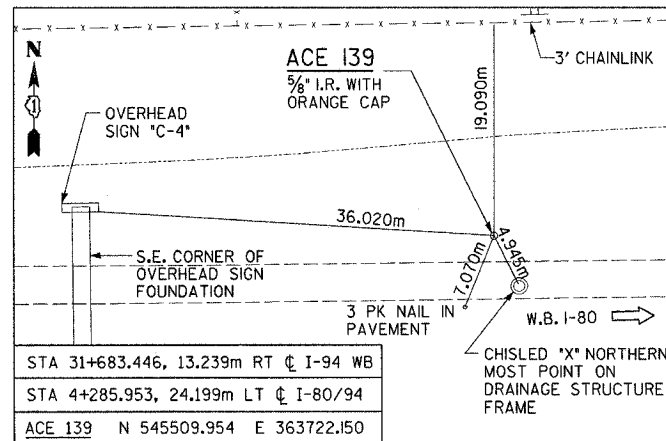
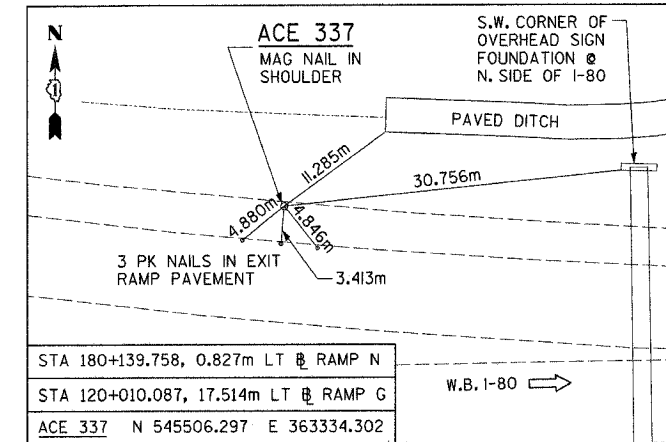
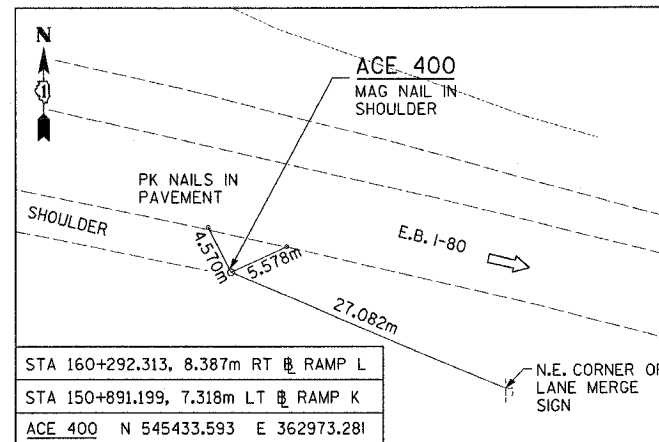
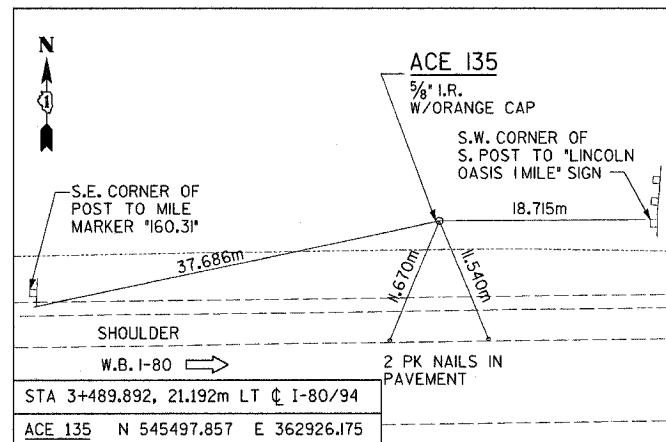

BENCHMARKS

B.M. ASC220	SQUARE CUT ON SOUTHEAST CORNER OF ILL 394 NORTHBOUND LANE BRIDGE OVER I-80 (LOWER LEVEL). ELEV=184.942	T.B.M. 117	SET CUT BOX ON CRASHWALL NE CORNER OF BRIDGE TO IL 394 SOUTH, WESTBOUND I-80, APPROXIMATELY MILE MARKER 160.61. ELEV=185.164
T.B.M. 200	CHISELED "X" ON NORTHEAST BOLT OF LIGHT POLE #DEF2 LOCATED AT SOUTHEAST QUADRANT OF IL 394 & I-80 RAMP INTERCHANGE. ELEV=184.031	T.B.M. 118	SET CUT BOX ON CRASHWALL NE CORNER OF NE WINGWALL, WESTBOUND I-80 AT MILE MARKER 0, RAILROAD BRIDGE. ELEV=190.545
T.B.M. 216	CHISELED BOX ON NORTHEAST CORNER OF METAL BASE OF #DEF5 LIGHT POLE LOCATED AT SOUTHWEST QUADRANT OF IL 394 AND I-80. ELEV=185.034	T.B.M. 300	SET CUT BOX AT SE END OF CRASHWALL AT THORN CREEK BRIDGE TO WESTBOUND I-94 FROM WESTBOUND I-80. ELEV=183.791
T.B.M. 217	FOUND 'CUT' BOX ON NORTHEAST CORNER OF CEMENT BOX TRUST FOUNDATION #B1 +/-250m WEST OF IL 394 ON I-80. ELEV=190.636	T.B.M. 301	RAILROAD SPIKE IN SW SIDE OF 0.55m TREE (+/- 380m) NORTH OF T.B.M. 300 LOCATED +/- 6m EAST OF SHOULDER WHERE IL 394 NORTHBOUND RAMPS MERGES WITH I-94 WESTBOUND. ELEV=184.726
T.B.M. 218	CHISELED BOX ON NORTHWEST CORNER OF CRASHWALL OF EASTBOUND I-80 OVER RAILROAD BRIDGE JUST WEST OF IL 394 ON SOUTH SIDE OF I-80. ELEV=196.229	T.B.M. 316	SET CUT BOX ON FOUNDATION OF OVERHEAD SIGN TRUSS (C3) NE CORNER OF EXIT RAMP TO I-80 WESTBOUND; APPROXIMATELY MILE MARKER 74.30. ELEV=183.274
T.B.M. 221	CHISELED BOX ON SOUTHWEST CORNER OF CONCRETE FOUNDATION OF BOX SIGN TRUST ON NORTHBOUND IL 394 APPROXIMATELY 300m SOUTH OF I-80 ON WEST FOUNDATION OF SIGN #D4. ELEV=185.164	T.B.M. 617	A STANDARD DISK STAMPED K25E SET ON TOP OF THE SOUTH END OF THE WEST PIER OF THE CALUMET EXPRESSWAY WESTBOUND GRADE SEPARATION OVERPASS TRI-STATE EXPRESSWAY SEC. 25-36-14 ELEV=188.016

NOTES:

- MONUMENTS, BENCHMARKS AND TIE POINTS MAY HAVE BEEN REMOVED AND RELOCATED UNDER PREVIOUS CONTRACTS. COORDINATE MONUMENTS AND TIE POINTS WITH RESIDENT ENGINEER.

TB-7

REVISIONS		ILLINOIS DEPARTMENT OF TRANSPORTATION F.A.I. ROUTE 80/94 (INTERSTATE 80/294)
NAME	DATE	
SCALE: NONE		DRAWN BY: CTT CHECKED BY: RCH
DATE: JULY 18, 2005		
 McDonough Associates Inc. Engineers / Architects		

170th STREET

I-94

EB I-94

WB I-94

RAMP H

MT-14

RAMP G

THORN CREEK

RAMP F

MT-6,12,16

THORN CREEK

MT-5,11,15

RAMP J

MT-4,8,18

MT-9,19

MT-10,20

CANADIAN NATIONAL R.R.

RAMP E

MT-7,13,17

RAMP K

RAMP L

RAMP V

RAMP N

RAMP M

I-394

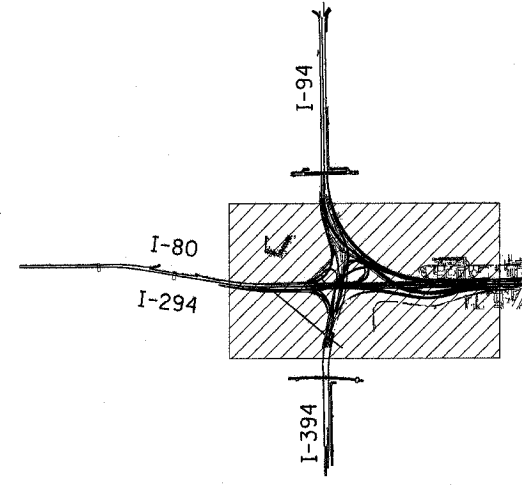
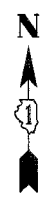

PROJECT LOCATION MAP

SCALE - 1:30000

IL. RT. 83

I-80
I-94

WENTWORTH AV.

F.A.I. RTE.	SECTION	COUNTY	TOTAL SHEETS	SHEET NO.
80/94	*	COOK	231	30
STA.		TO STA.		
FED. ROAD DIST. NO. 1		ILLINOIS FED. AID PROJECT		
*10203.1 & 0304) R-6		CONTRACT # 62105		



LEGEND

- - - EXISTING
- LOCATION OF PROPOSED WORK

TM-1

ILLINOIS DEPARTMENT OF TRANSPORTATION
F.A.I. ROUTE 80/94 (INTERSTATE 80/294)

MAINTENANCE OF TRAFFIC
KEY MAP

SCALE - 1:3000
DATE: JULY 18, 2005

DRAWN BY: AAS
CHECKED BY: RCH

McDonough Associates Inc.
Engineers / Architects

REVISIONS	
NAME	DATE

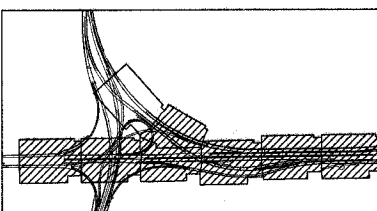

F.A.I. RTE.	SECTION	COUNTY	TOTAL SHEETS	SHEET NO.
80/94	*	COOK	231	31
STA.		TO STA.		
FED. ROAD DIST. NO. 1		ILLINOIS	FED. AID PROJECT	
*(0203.1 & 0304) R-6		CONTRACT # 62105		

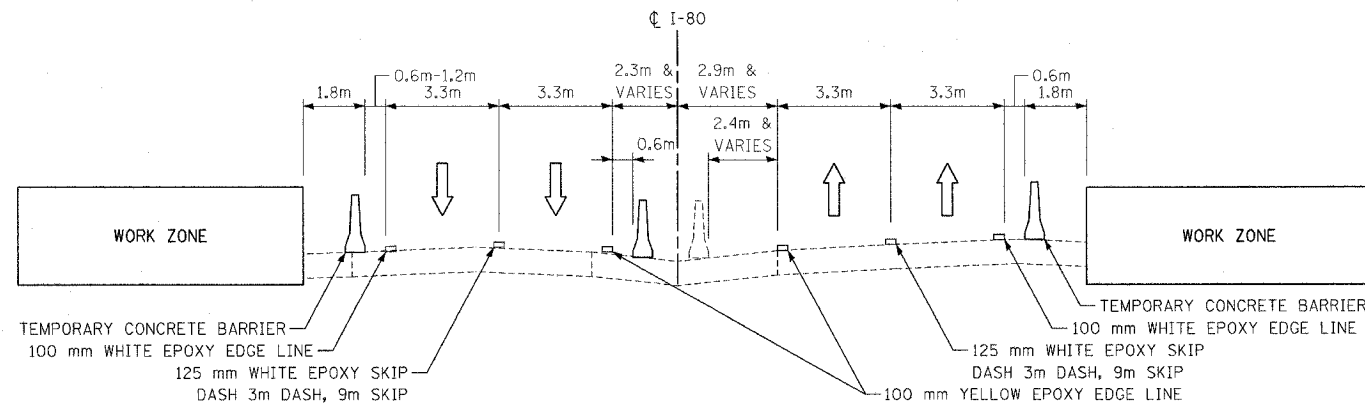

STAGE 1 MAINTENANCE OF TRAFFIC TYPICAL SECTION - INTERSTATE 80
 STA. 2+967.7 TO STA. 3+550.0 ϕ I-80 (EB)
 STA. 2+967.7 TO STA. 3+550.0 ϕ I-80 (WB)

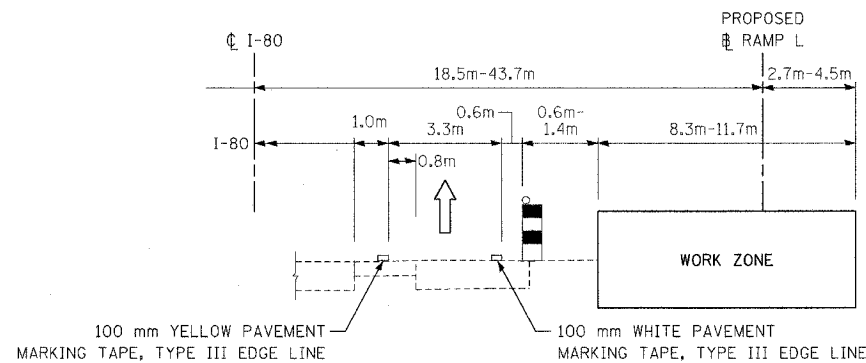

STAGE 1 MAINTENANCE OF TRAFFIC TYPICAL SECTION - RAMP L
 STA. 3+303.0 ϕ I-80 = STA. 160+057.0 ϕ RAMP L
 STA. 160+057.0 TO STA. 160+325.3 ϕ RAMP L

RECOMMENDED STAGING SEQUENCE

TRAFFIC LOCATION

STAGE 1:
 I-80/94 WB EXISTING I-80/94 WB (STA. 4+105.0 TO STA. 4+500.0 ϕ I-80)
 I-80 WB TEMPORARY RAMP N TO EXISTING I-80 WB (STA. 2+967.7 TO STA. 4+105.0 ϕ I-80 = STA. 31+503.0 ϕ I-94)
 I-94 WB EXISTING I-94 WB
 I-80 EB EXISTING I-80 EB
 I-94 EB EXISTING I-94 EB
 RAMP H EXISTING RAMP H
 RAMP L EXISTING RAMP L

STAGE 1A:
 I-80/94 WB EXISTING I-80/94 WB (STA. 4+098.0 TO STA. 4+500.0 ϕ I-80)
 I-80 WB TEMPORARY RAMP N TO EXISTING I-80 WB (STA. 2+967.7 TO STA. 4+105.0 ϕ I-80 = STA. 31+503.0 ϕ I-94)
 I-94 WB EXISTING I-94 WB
 I-80 EB EXISTING I-80 EB
 I-94 EB EXISTING I-94 EB
 RAMP H PROPOSED RAMP H (STA. 130+750.0 TO STA. 131+100.0 = STA. 3+136.4 TO STA. 2+975.0 ϕ I-80)
 RAMP L PROPOSED RAMP L

STAGE 2:
 I-80/94 WB EXISTING I-94 WB (STA. 31+503.0 TO STA. 31+897.5 ϕ I-94 WB = STA. 4+500.0 ϕ I-80)
 I-80 WB RAMP N TO PROPOSED I-80 WB (STA. 3+547.0 TO STA. 4+105.0 ϕ I-80 = 31+503.0 ϕ I-94)
 I-94 WB EXISTING I-94 WB
 I-80 EB PROPOSED I-80 EB (STA. 2+967.7 TO STA. 4+500.0 ϕ I-80)
 I-94 EB EXISTING I-94 EB
 RAMP H PROPOSED RAMP H TO PROPOSED I-80 WB
 RAMP L PROPOSED RAMP L

M.O.T. GENERAL NOTES

- ALL WORK INCLUDING SHOULDER REMOVAL, EXCAVATING GRADING AND CONSTRUCTING TEMPORARY PAVEMENT SHALL BE COMPLETED USING HIGHWAY STANDARDS 701400, 701401, AND WITHIN THE ALLOWABLE LANE CLOSURE HOURS AS MENTIONED IN THE SPECIAL PROVISIONS FOR KEEPING THE EXPRESSWAY OPEN TO TRAFFIC.
- THE CONTRACTOR SHALL CONSTRUCT TEMPORARY PAVEMENT AS SPECIFIED IN THE SPECIAL PROVISIONS AND AS DIRECTED AND TO THE SATISFACTION OF THE ENGINEER. THE CONTRACTOR SHALL MAINTAIN THE TEMPORARY PAVEMENT FOR THE DURATION OF THE CONTRACT. SEE SPECIAL PROVISION FOR MAINTENANCE OF ROADWAYS.
- GUARDRAIL WILL BE IN PLACE BEFORE TRAFFIC IS PLACED ADJACENT ANY ROADSIDE OBSTACLES.
- SIGN TEXT AND COLOR SHALL BE PER MUTCD UNLESS OTHERWISE SPECIFIED.
- EXISTING PAVEMENT MARKINGS THAT CONFLICT WITH TEMPORARY MARKINGS SHALL BE REMOVED AND PAID FOR AT THE CONTRACT UNIT PRICE PER SQUARE METER FOR "WORK ZONE PAVEMENT MARKING REMOVAL" FOR TEMPORARY PAVEMENT MARKINGS AND "PAVEMENT MARKING REMOVAL" FOR PERMANENT PAVEMENT MARKINGS. IN ADDITION, THE CRYSTALS IN THE EXISTING RAISED REFLECTIVE MARKERS SHALL BE REMOVED AND PAID FOR AT THE CONTRACT UNIT PRICE EACH FOR "RAISED REFLECTIVE PAVEMENT MARKER REMOVAL."
- THE BARRICADES AND SIGNS NOTED TO REMAIN SHALL BECOME THE PROPERTY OF THE DEPARTMENT ON THE DATE THAT THE ADJACENT LANE IS PERMANENTLY OPENED TO TRAFFIC AND AS ACCEPTED BY THE ENGINEER. THIS WORK WILL NOT BE PAID FOR SEPARATELY, BUT SHALL BE INCLUDED FOR PAYMENT AS PART OF "TRAFFIC CONTROL AND PROTECTION (EXPRESSWAYS)." ALL BARRICADES AND TEMPORARY GROUND MOUNT SIGNS ARE TO BE REMOVED FROM THE JOBSITE AT THE END OF THE CONTRACT.
- STATIC SIGNS ARE REQUIRED AS 2 WEEK NOTICE FOR THE FOLLOWING LOCATIONS. WHERE A RAMP IS CLOSED FOR MORE THAN 1 DAY, A ROAD IS CLOSED FOR MORE THAN 1 DAY, OR A LANE IS CLOSED FOR MORE THAN 1 DAY (SUCH AS FOR BRIDGE RECONSTRUCTIONS OR OTHER WORK WHERE TEMPORARY CONCRETE BARRIER IS USED).

MT-1

REVISIONS		ILLINOIS DEPARTMENT OF TRANSPORTATION F.A.I. ROUTE 80/94 (INTERSTATE 80/294)
NAME	DATE	
		MAINTENANCE OF TRAFFIC TYPICAL SECTIONS DATE: JULY 18, 2005 DRAWN BY: AAS CHECKED BY: RCH McDonough Associates Inc. Engineers / Architects

F.A.I. RTE.	SECTION	COUNTY	TOTAL SHEETS	SHEET NO.
80/94	*	COOK	231	32
STA.		TO STA.		
FED. ROAD DIST. NO. 1		ILLINOIS FED. AID PROJECT		
*(0203.1 & 0304) R-6		CONTRACT # 62105		

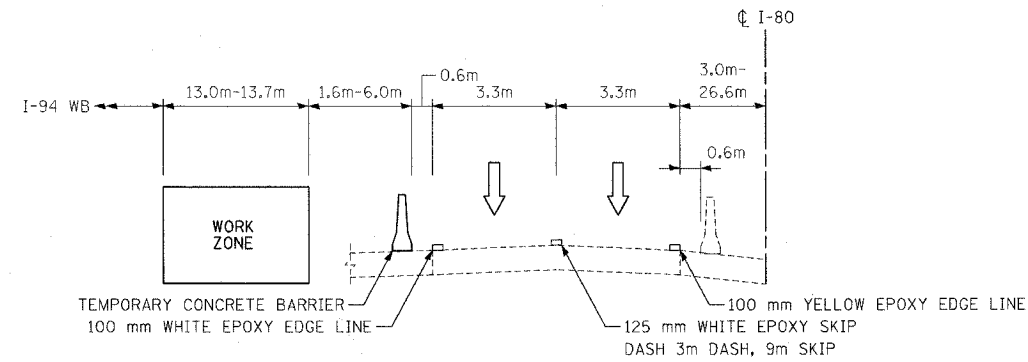

STAGE 1 MAINTENANCE OF TRAFFIC TYPICAL SECTION - INTERSTATE 80 WB
 STAGE 1A MAINTENANCE OF TRAFFIC TYPICAL SECTION - INTERSTATE 80 WB
 STA. 3+550.0 TO STA. 3+956.9 @ I-80

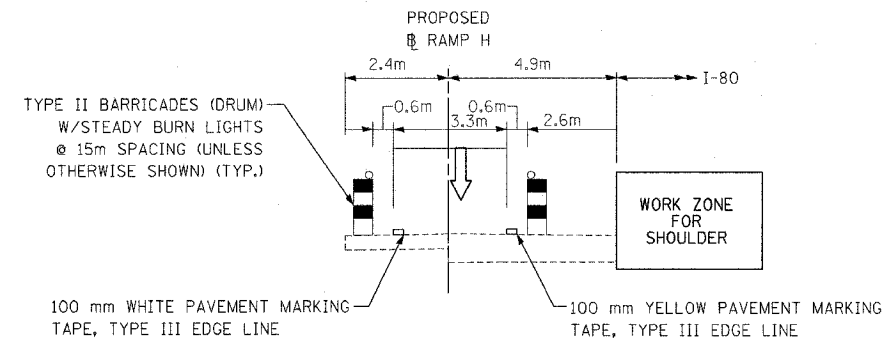

STAGE 1A MAINTENANCE OF TRAFFIC TYPICAL SECTION - RAMP H
 LOOKING DOWN STATION
 STA. 130+750.0 @ RAMP H TO STA. 2+900.0 @ I-80 (EB)

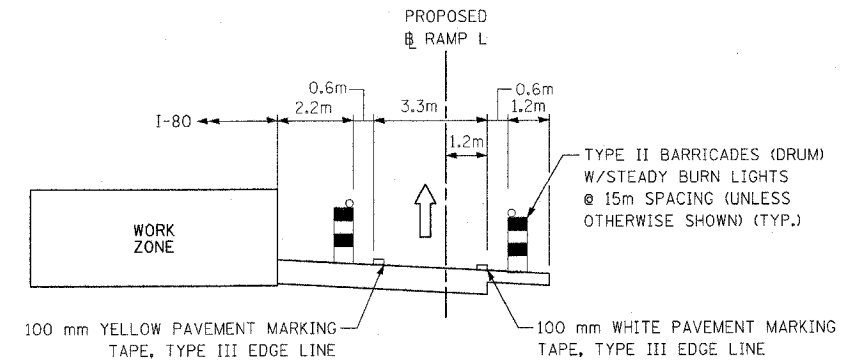

STAGE 1A MAINTENANCE OF TRAFFIC TYPICAL SECTION - RAMP L
 STA. 3+042.8 @ I-80 TO STA. 160+325.3 @ RAMP L

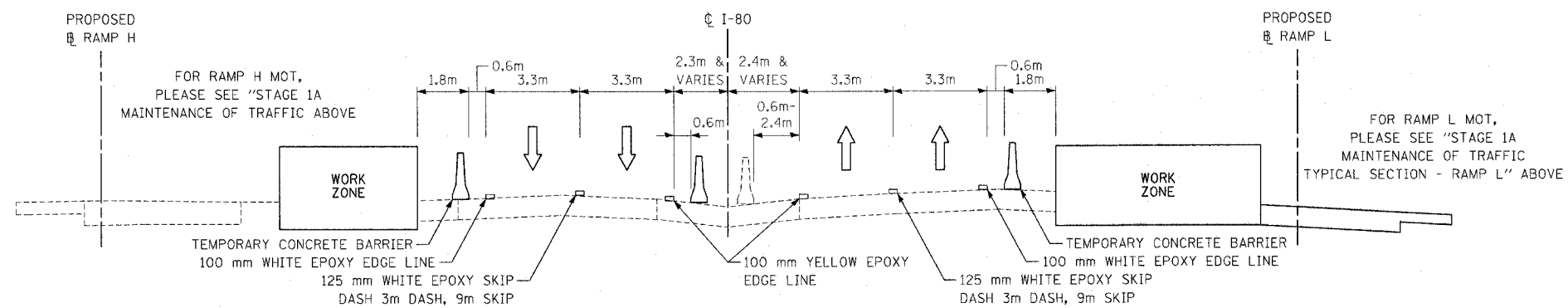

STAGE 1A MAINTENANCE OF TRAFFIC TYPICAL SECTION - INTERSTATE 80
 STA. 2+967.7 TO STA. 3+550.0 @ I-80 (EB)
 STA. 2+967.7 TO STA. 3+550.0 @ I-80 (WB)

MT-2

REVISIONS		ILLINOIS DEPARTMENT OF TRANSPORTATION F.A.I. ROUTE 80/94 (INTERSTATE 80/294)
NAME	DATE	
		MAINTENANCE OF TRAFFIC TYPICAL SECTIONS DATE: JULY 18, 2005 DRAWN BY: AAS CHECKED BY: RCH

F.A.I. RTE.	SECTION	COUNTY	TOTAL SHEETS	SHEET NO.
80/94	*	COOK	231	33
STA.		TO STA.		
FED. ROAD DIST. NO. 1		ILLINOIS FED. AID PROJECT		
*(0203.1 & 0304) R-6		CONTRACT # 62105		

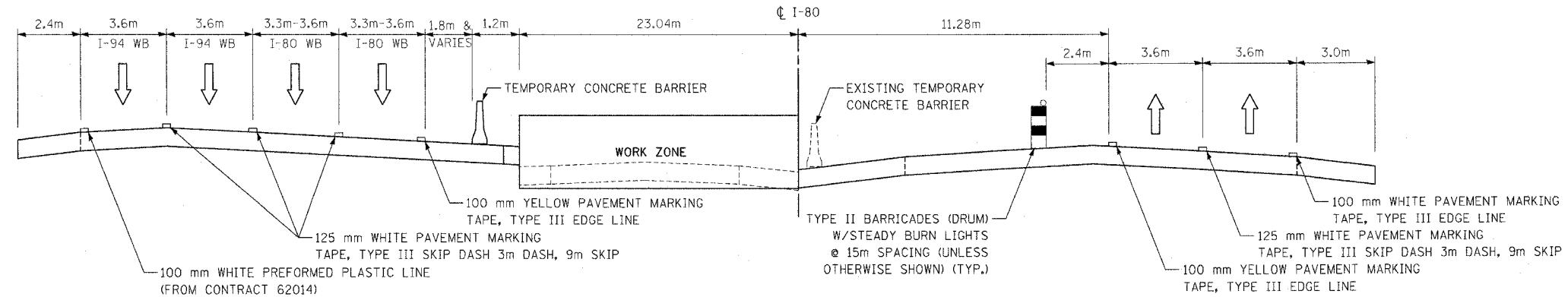

STAGE 2 MAINTENANCE OF TRAFFIC TYPICAL SECTION - INTERSTATE 80
STA. 4+105.5 TO STA. 4+500.0 ϕ I-80

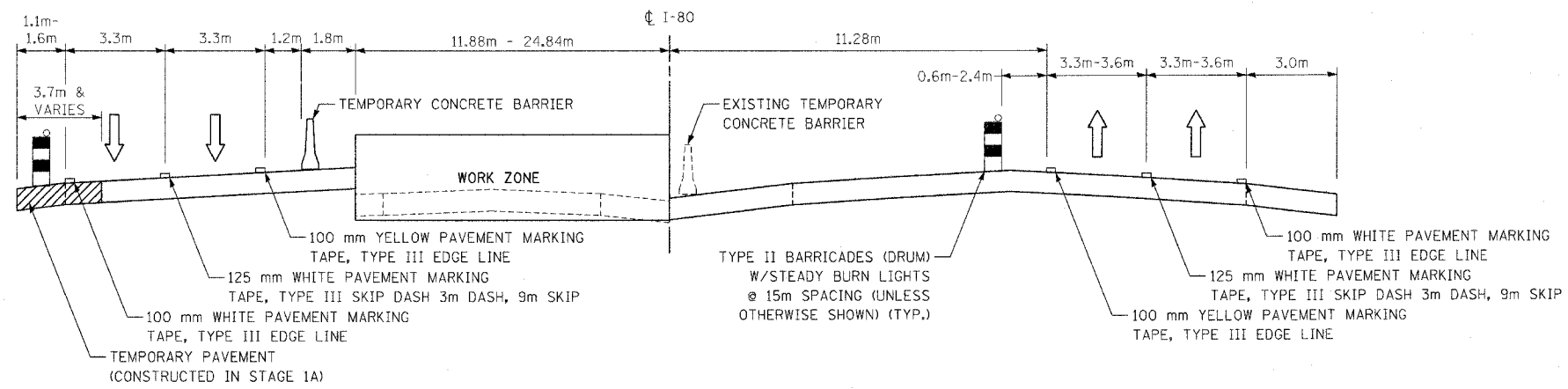

STAGE 2 MAINTENANCE OF TRAFFIC TYPICAL SECTION - INTERSTATE 80
(LANE WIDTH TRANSITIONS FROM 3.3m TO 3.6m
FROM STA. 3+550.0 TO STA. 3+630.0 FOR I-80 EB)
STA. 3+550.0 TO STA. 4+105.5 ϕ I-80

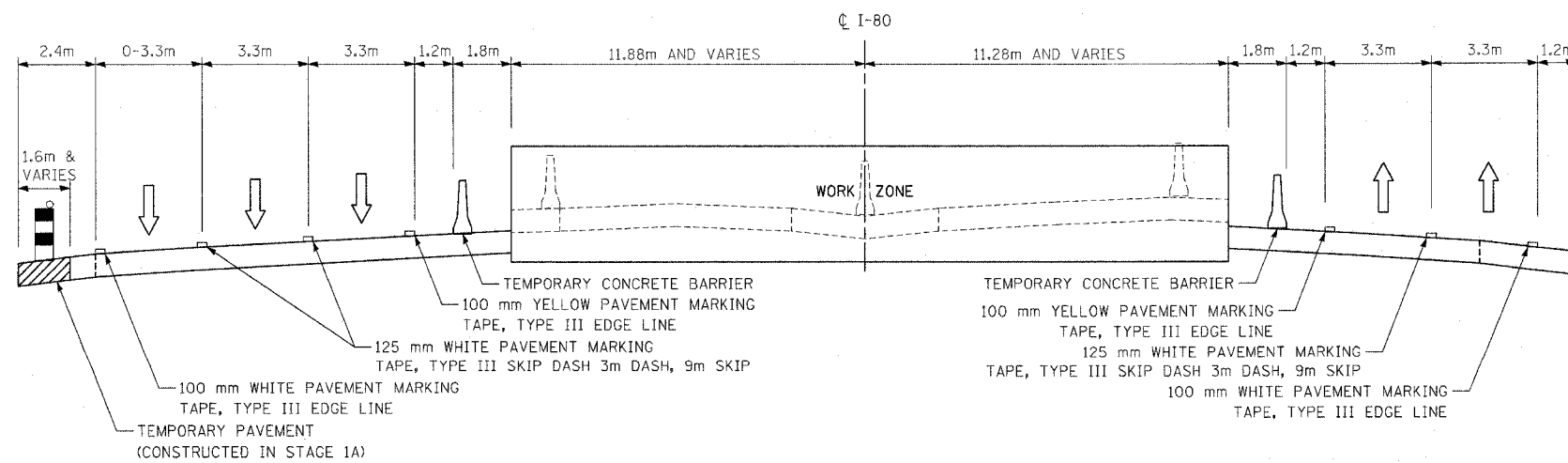

STAGE 2 MAINTENANCE OF TRAFFIC TYPICAL SECTION - INTERSTATE 80
STA. 2+967.7 TO STA. 3+550.0 ϕ I-80

MT-3

REVISIONS		ILLINOIS DEPARTMENT OF TRANSPORTATION F.A.I. ROUTE 80/94 (INTERSTATE 80/294)	
NAME	DATE		

DATE: JULY 18, 2005
DRAWN BY: AAS
CHECKED BY: RCH

McDonough Associates Inc.
Engineers / Architects

F.A.I. RTE.	SECTION	COUNTY	TOTAL SHEETS	SHEET NO.
80/94	*	COOK	231	34
STA. 3+750.00		TO STA. 4+100.00		
FED. ROAD DIST. NO. 1		ILLINOIS FED. AID PROJECT		
*(0203.1 & 0304) R-6		CONTRACT # 62105		

PROP. CURVE MDPW80-1
 PI STA = 10+057.448
 $\Delta = 10^\circ 56' 18''$ (LT)
 R = 600.000 m
 T = 57.448 m
 L = 114.547 m
 E = 2.744 m
 e = N/A
 T.R. = N/A
 S.E. RUN. = N/A
 P.C. STA = 10+000.000
 P.T. STA = 10+114.547

PROP. CURVE MDPW80-2
 PI STA = 10+186.829
 $\Delta = 10^\circ 56' 19''$ (RT)
 R = 593.400 m
 T = 56.818 m
 L = 113.290 m
 E = 2.714 m
 e = N/A
 T.R. = N/A
 S.E. RUN. = N/A
 P.C. STA = 10+130.012
 P.T. STA = 10+243.300

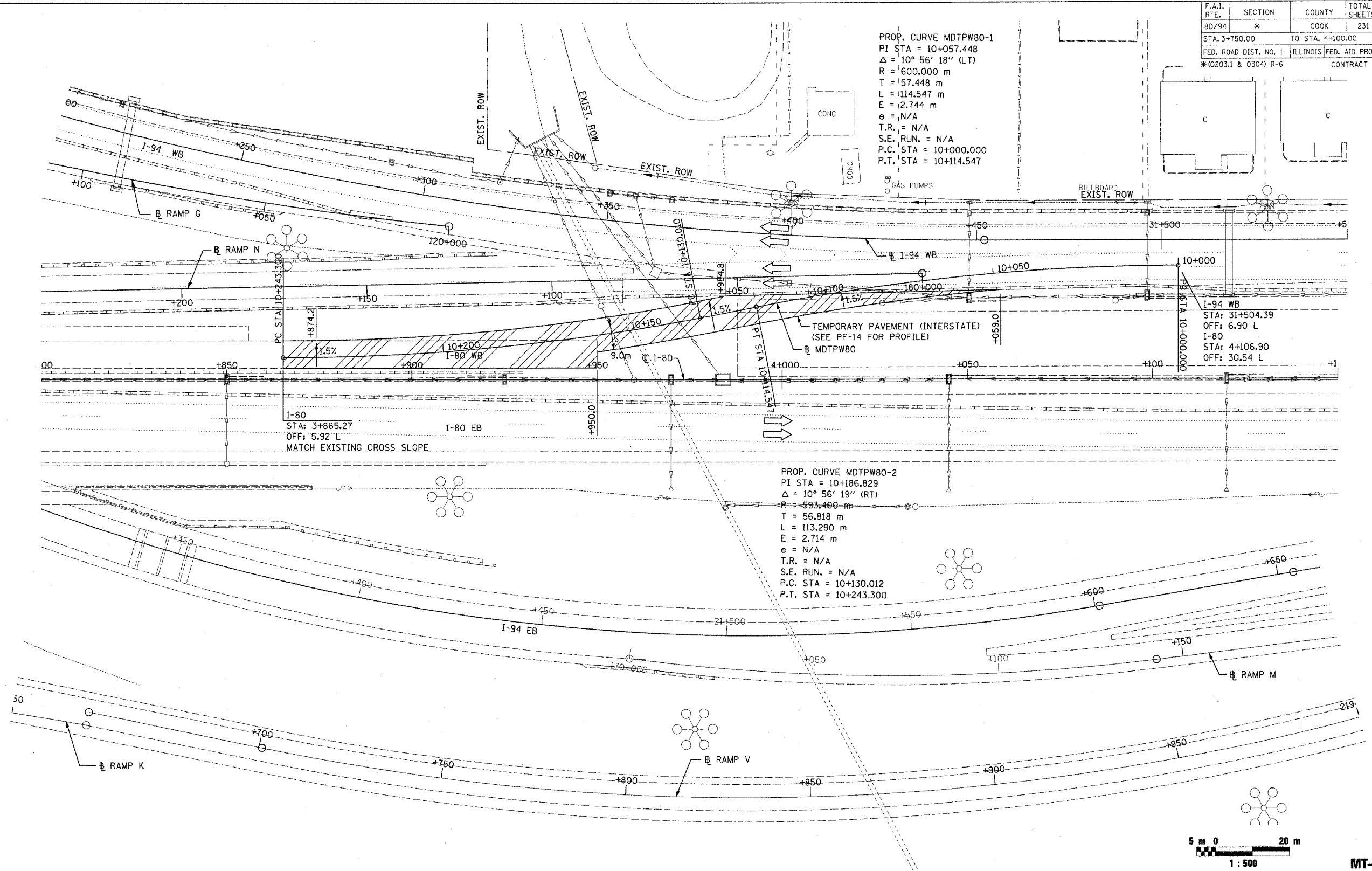

MT-4

LEGEND

	WORK ZONE
	TEMPORARY PAVEMENT (INTERSTATE)

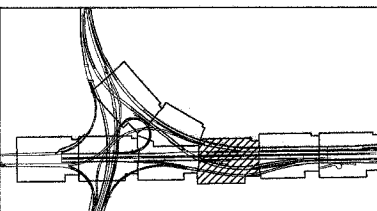

REVISIONS	
NAME	DATE

ILLINOIS DEPARTMENT OF TRANSPORTATION
 F.A.I. ROUTE 80/94 (INTERSTATE 80/294)
 MAINTENANCE OF TRAFFIC
 PRE-STAGE WORK
 RAMP N CROSSOVER
 DATE: JULY 18, 2005
 DRAWN BY: AAS
 CHECKED BY: RCH
 McDonough Associates Inc.
 Engineers / Architects

F.A.I. RTE.	SECTION	COUNTY	TOTAL SHEETS	SHEET NO.
80/94	*	COOK	231	35
STA. 2+700.00		TO STA. 3+050.00		
FED. ROAD DIST. NO. 1		ILLINOIS FED. AID PROJECT		
*10203.1 & 0304) R-6		CONTRACT # 62105		



* THE CONTRACTOR SHALL COORDINATE WITH THE ADJACENT CONTRACTOR WHEN ORDERING AND INSTALLING THE TEMPORARY BARRIER WALL. THIS WALL SHALL BE THE SAME SHAPE, EITHER NEW JERSEY OR F-SHAPE BARRIER. THE MIXING OF TYPES OF WALL WILL NOT BE PERMITTED.

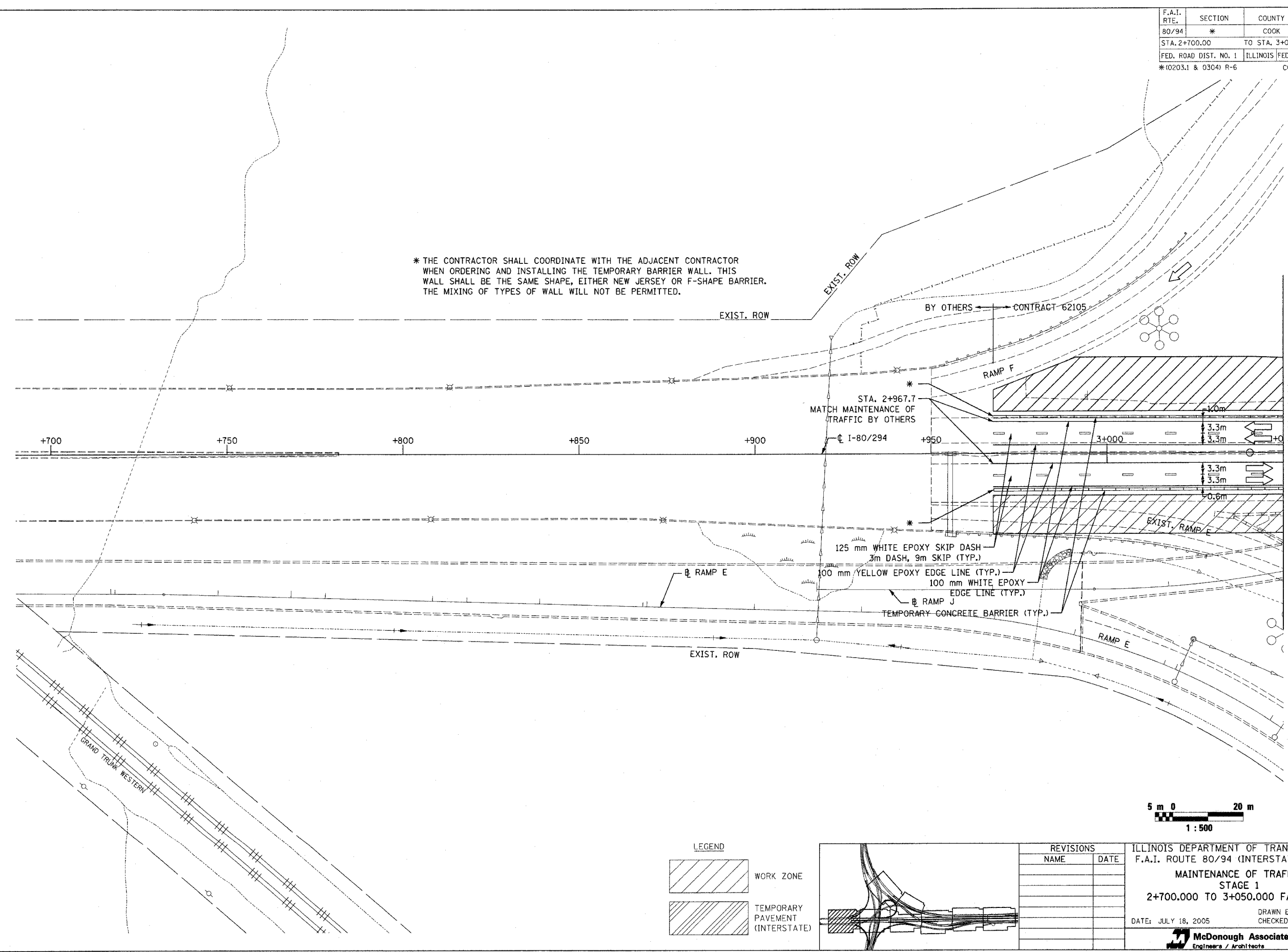

MATCH LINE STA. 3+050 I-80
SEE SHEET MT-6

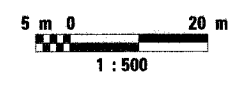

MT-5

LEGEND

	WORK ZONE
	TEMPORARY PAVEMENT (INTERSTATE)

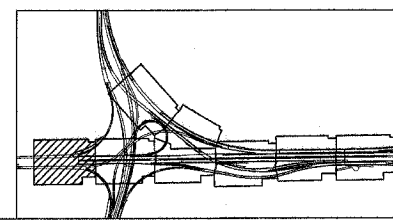

REVISIONS	
NAME	DATE

ILLINOIS DEPARTMENT OF TRANSPORTATION
 F.A.I. ROUTE 80/94 (INTERSTATE 80/294)
MAINTENANCE OF TRAFFIC
 STAGE 1
 2+700.000 TO 3+050.000 FAI 80/94
 DATE: JULY 18, 2005
 DRAWN BY: AAS
 CHECKED BY: RCH
 McDonough Associates Inc.
 Engineers / Architects

F.A.I. RTE.	SECTION	COUNTY	TOTAL SHEETS	SHEET NO.
80/94	*	COOK	231	36
STA. 3+050.00		TO STA. 3+400.00		
FED. ROAD DIST. NO. 1		ILLINOIS FED. AID PROJECT		
*(0203.1 & 0304) R-6		CONTRACT # 62105		

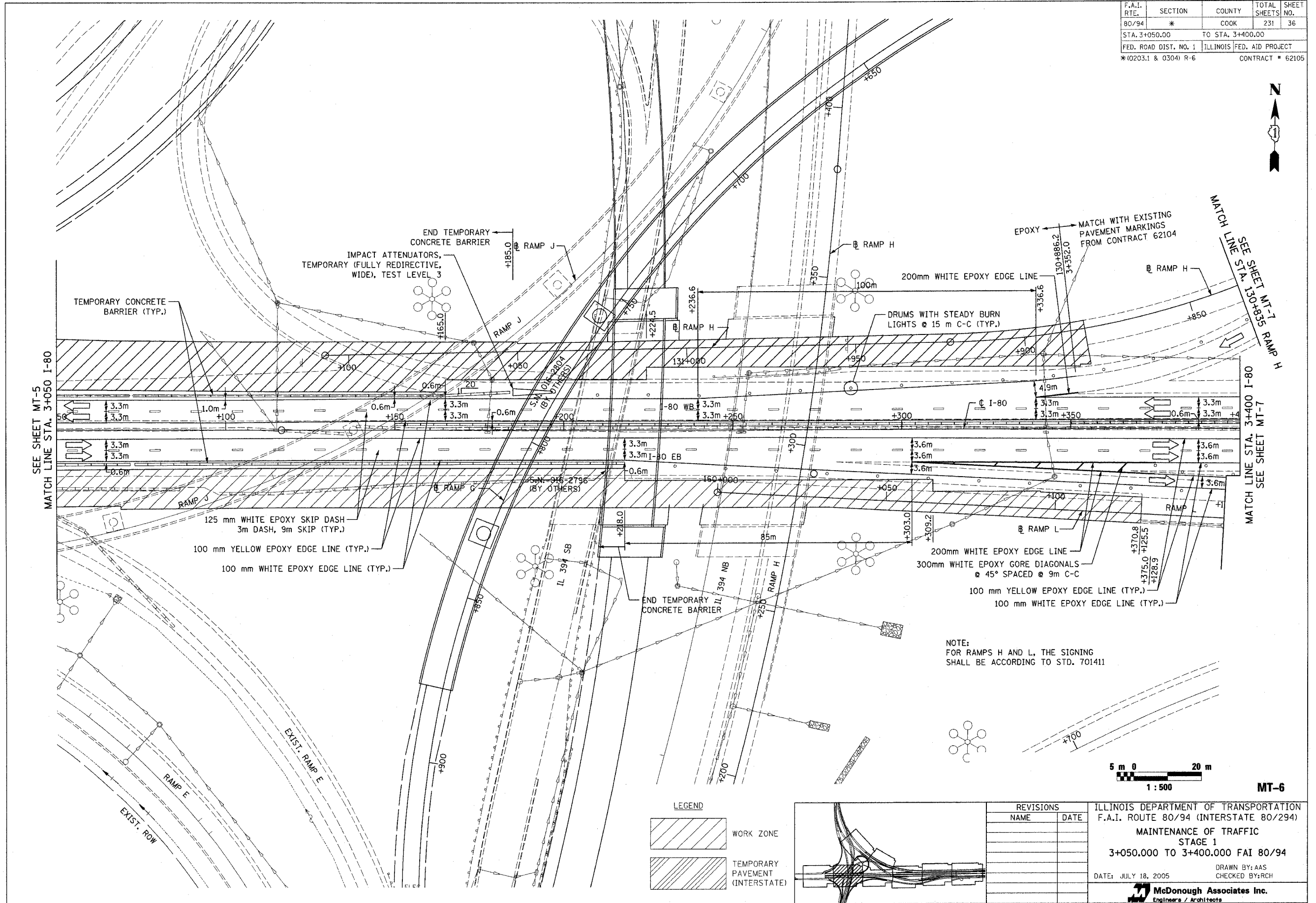

SEE SHEET MT-5
MATCH LINE STA. 3+050 I-80

MATCH LINE STA. 3+400 I-80
SEE SHEET MT-7

125 mm WHITE EPOXY SKIP DASH
3m DASH, 9m SKIP (TYP.)
100 mm YELLOW EPOXY EDGE LINE (TYP.)
100 mm WHITE EPOXY EDGE LINE (TYP.)

NOTE:
FOR RAMPS H AND L, THE SIGNING
SHALL BE ACCORDING TO STD. 701411



MT-6

LEGEND

	WORK ZONE
	TEMPORARY PAVEMENT (INTERSTATE)

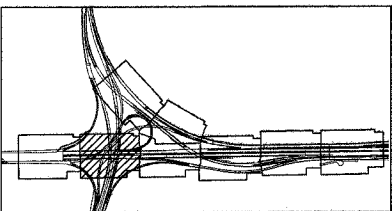

REVISIONS	
NAME	DATE

ILLINOIS DEPARTMENT OF TRANSPORTATION
F.A.I. ROUTE 80/94 (INTERSTATE 80/294)
MAINTENANCE OF TRAFFIC
STAGE 1
3+050.000 TO 3+400.000 FAI 80/94
DATE: JULY 18, 2005
DRAWN BY: AAS
CHECKED BY: RCH
McDonough Associates Inc.
Engineers / Architects

F.A.I. RTE.	SECTION	COUNTY	TOTAL SHEETS	SHEET NO.
80/94	*	COOK	231	37
STA. 3+400.00		TO STA. 3+750.00		
FED. ROAD DIST. NO. 1		ILLINOIS FED. AID PROJECT		
*(0203.1 & 0304) R-6		CONTRACT # 62105		

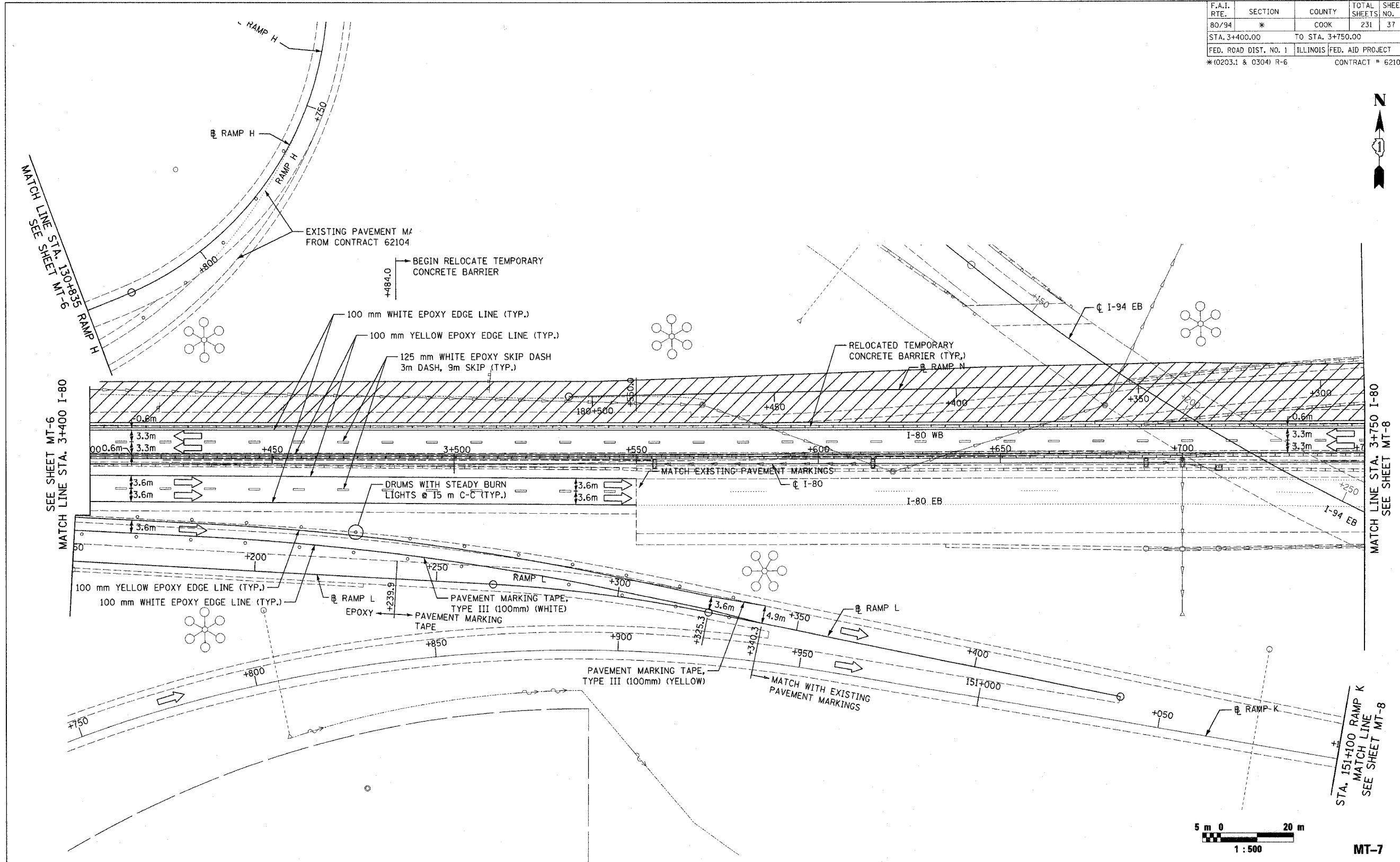

SEE SHEET MT-6
MATCH LINE STA. 3+400 I-80

MATCH LINE STA. 3+750 I-80
SEE SHEET MT-8

STA. 151+100 RAMP K
MATCH LINE
SEE SHEET MT-8



MT-7

LEGEND

	WORK ZONE
	TEMPORARY PAVEMENT (INTERSTATE)

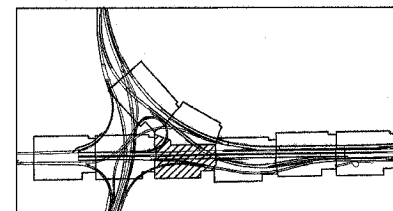

REVISIONS	
NAME	DATE

ILLINOIS DEPARTMENT OF TRANSPORTATION
F.A.I. ROUTE 80/94 (INTERSTATE 80/294)
MAINTENANCE OF TRAFFIC
STAGE 1
3+400.000 TO 3+750.000 FAI 80/94
DATE: JULY 18, 2005
DRAWN BY: AAS
CHECKED BY: RCH
McDonough Associates Inc.
Engineers / Architects

F.A.I. RTE.	SECTION	COUNTY	TOTAL SHEETS	SHEET NO.
80/94	*	COOK	231	38
STA. 3+750.00		TO STA. 4+100.00		
FED. ROAD DIST. NO. 1		ILLINOIS FED. AID PROJECT		
* (0203.1 & 0304) R-6		CONTRACT # 62105		

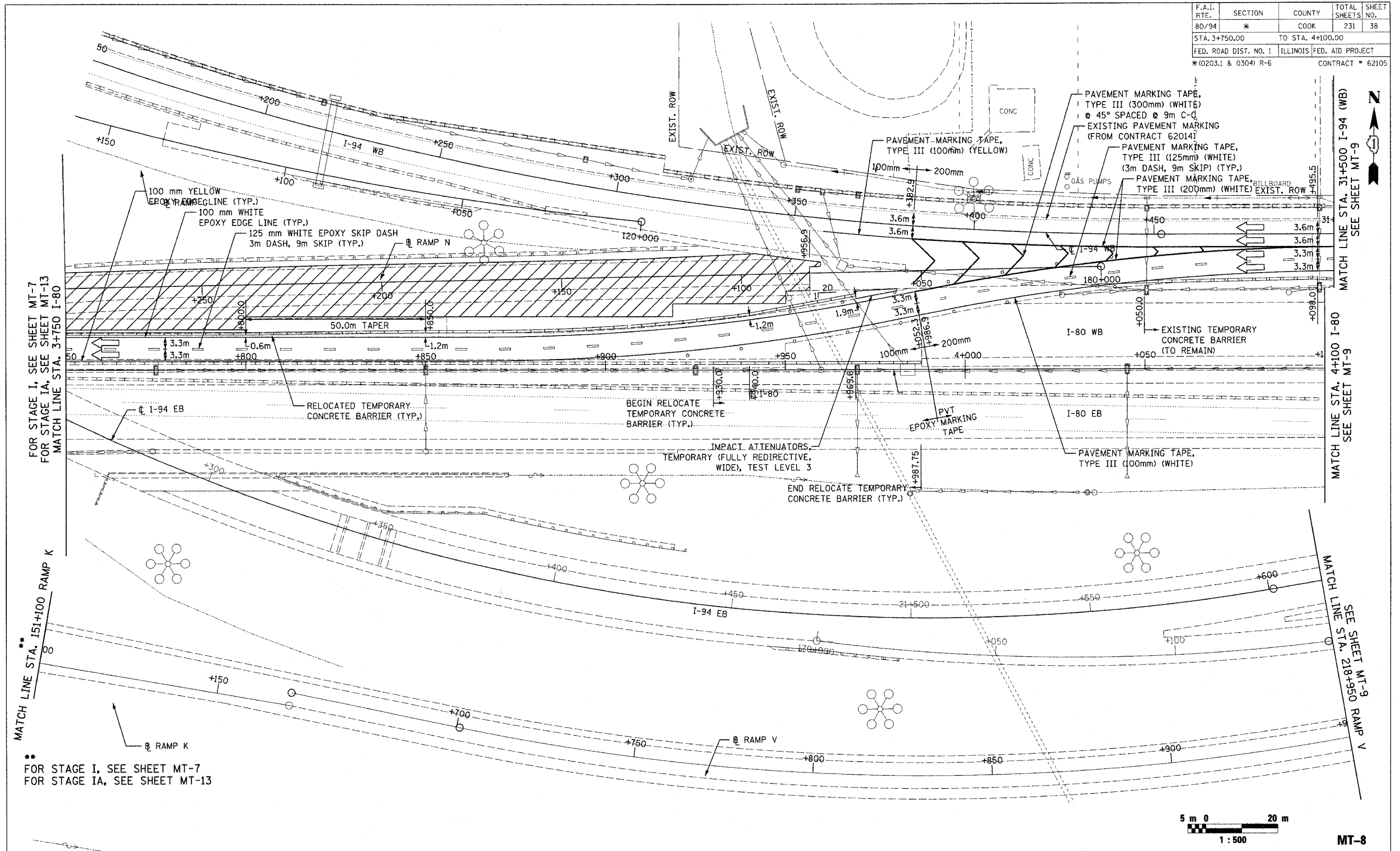

FOR STAGE I, SEE SHEET MT-7
FOR STAGE IA, SEE SHEET MT-13
MATCH LINE STA. 3+750 I-80

MATCH LINE STA. 151+100 RAMP K

** FOR STAGE I, SEE SHEET MT-7
FOR STAGE IA, SEE SHEET MT-13

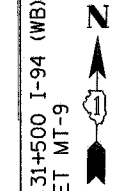

MATCH LINE STA. 31+500 I-94 (WB)
SEE SHEET MT-9

MATCH LINE STA. 4+100 I-80
SEE SHEET MT-9

MT-8

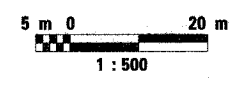

LEGEND

	WORK ZONE
	TEMPORARY PAVEMENT (INTERSTATE)

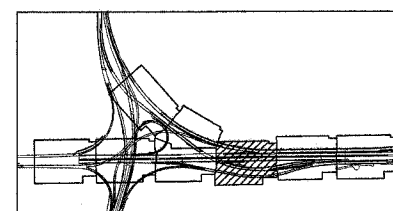

REVISIONS	
NAME	DATE

ILLINOIS DEPARTMENT OF TRANSPORTATION
F.A.I. ROUTE 80/94 (INTERSTATE 80/294)
MAINTENANCE OF TRAFFIC
STAGE 1
3+750.000 TO 4+100.000 FAI 80/94
DATE: JULY 18, 2005
DRAWN BY: AAS
CHECKED BY: RCH
McDonough Associates Inc.
Engineers / Architects

F.A.I. RTE.	SECTION	COUNTY	TOTAL SHEETS	SHEET NO.
80/94	*	COOK	231	39
STA. 4+100.00		TO STA. 4+450.00		
FED. ROAD DIST. NO. 1		ILLINOIS FED. AID PROJECT		
*(0203.1 & 0304) R-6		CONTRACT # 62105		

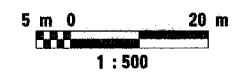
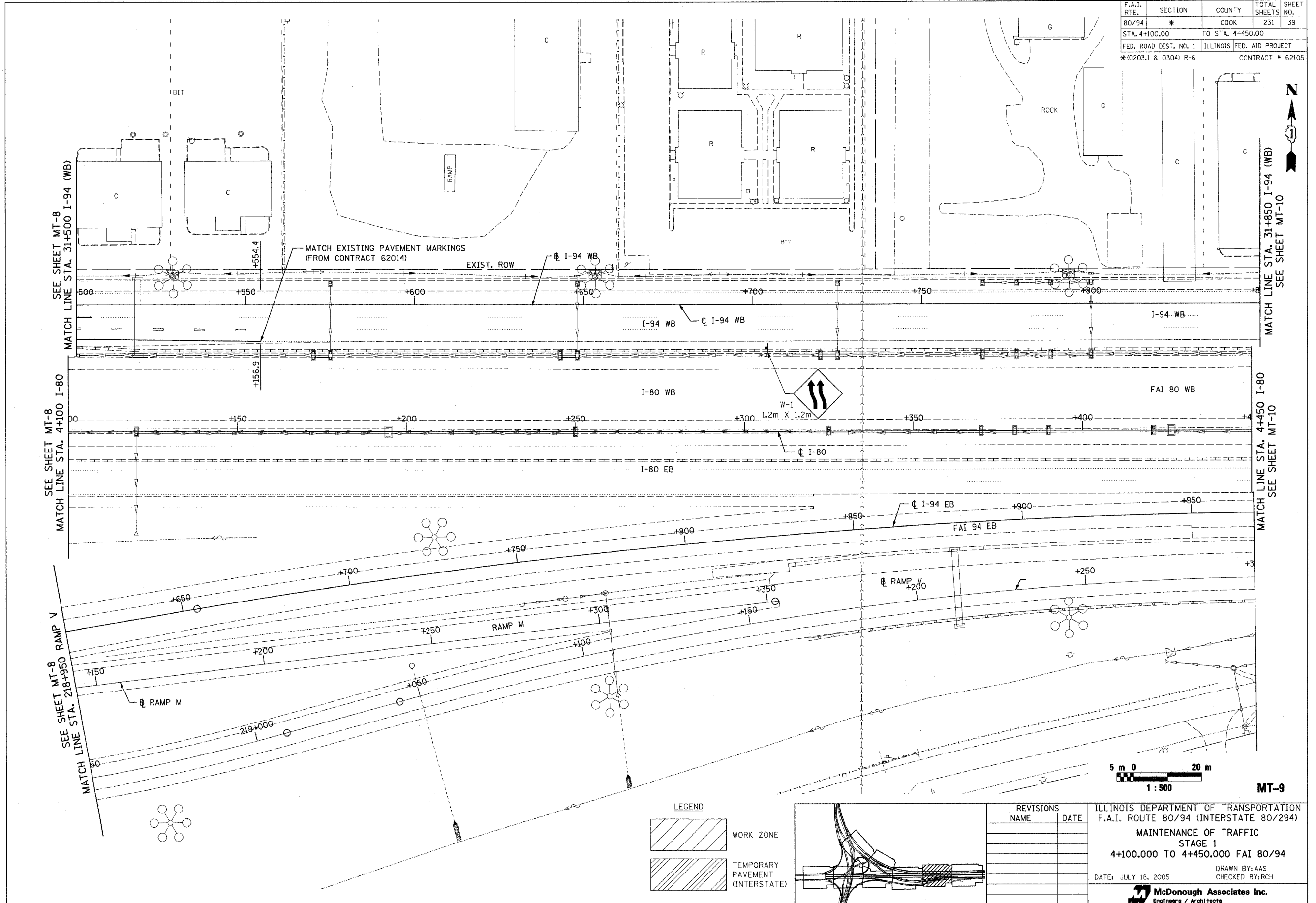

MT-9

LEGEND

	WORK ZONE
	TEMPORARY PAVEMENT (INTERSTATE)

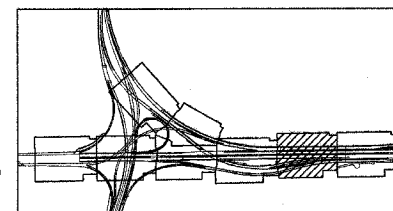

REVISIONS	
NAME	DATE

ILLINOIS DEPARTMENT OF TRANSPORTATION
 F.A.I. ROUTE 80/94 (INTERSTATE 80/294)
 MAINTENANCE OF TRAFFIC
 STAGE 1
 4+100.000 TO 4+450.000 FAI 80/94
 DATE: JULY 18, 2005
 DRAWN BY: AAS
 CHECKED BY: RCH
 McDonough Associates Inc.
 Engineers / Architects

F.A.I. RTE. 80/94	SECTION *	COUNTY COOK	TOTAL SHEETS 231	SHEET NO. 40
STA. 4+450.00		TO STA. 4+800.00		
FED. ROAD DIST. NO. 1		ILLINOIS FED. AID PROJECT		
*(0203.1 & 0304) R-6		CONTRACT # 62105		

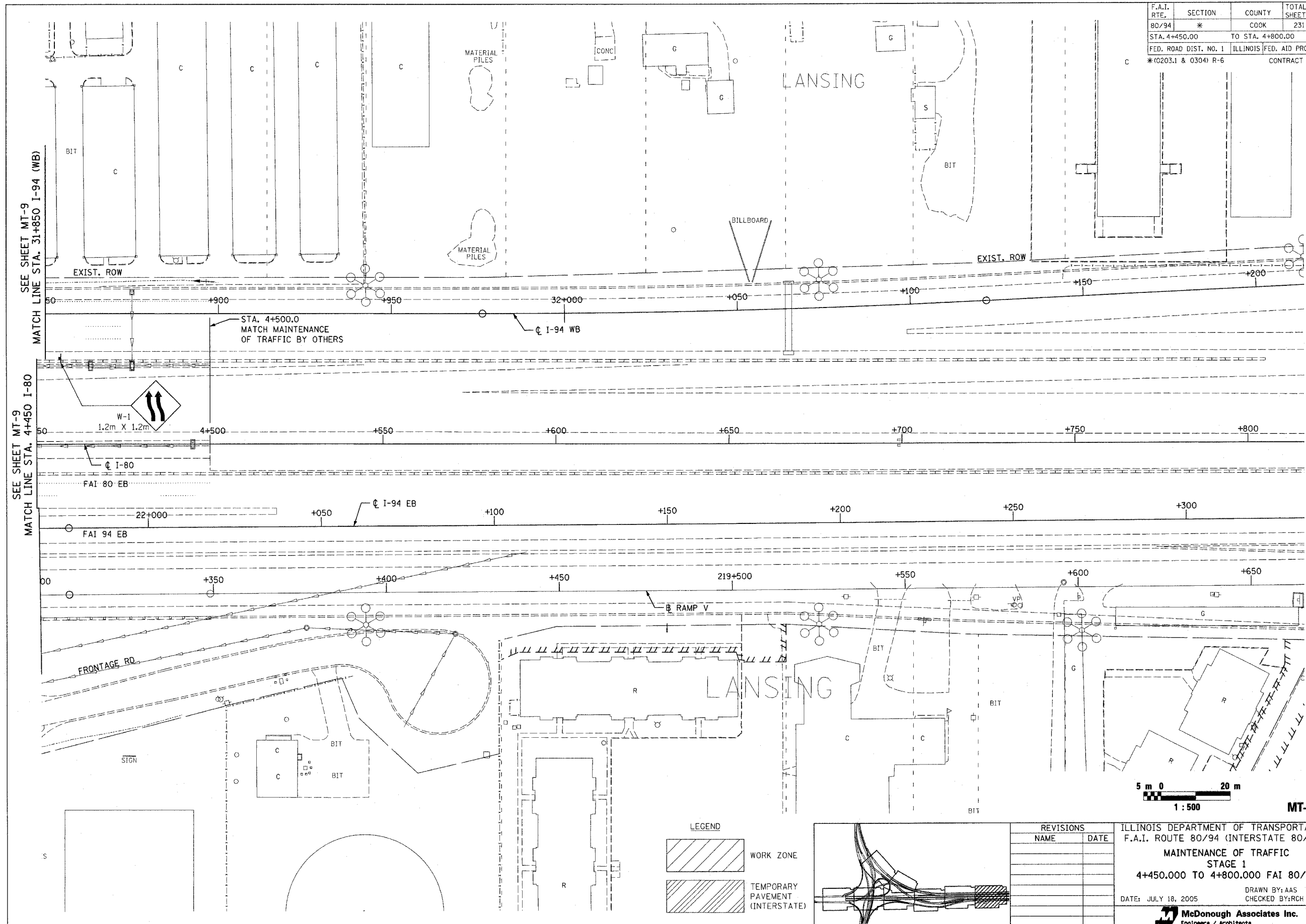

SEE SHEET MT-9
MATCH LINE STA. 31+850 I-94 (WB)

SEE SHEET MT-9
MATCH LINE STA. 4+450 I-80

STA. 4+500.0
MATCH MAINTENANCE
OF TRAFFIC BY OTHERS

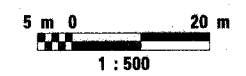

MT-10

LEGEND

	WORK ZONE
	TEMPORARY PAVEMENT (INTERSTATE)

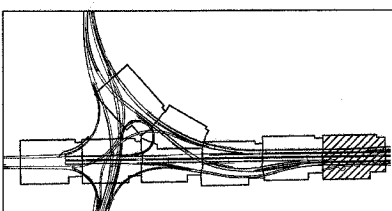

REVISIONS	
NAME	DATE

ILLINOIS DEPARTMENT OF TRANSPORTATION
F.A.I. ROUTE 80/94 (INTERSTATE 80/294)
MAINTENANCE OF TRAFFIC
STAGE 1
4+450.000 TO 4+800.000 FAI 80/94

DATE: JULY 18, 2005

DRAWN BY: AAS
CHECKED BY: RCH

McDonough Associates Inc.
Engineers / Architects

F.A.I. RTE.	SECTION	COUNTY	TOTAL SHEETS	SHEET NO.
80/94	*	COOK	231	41
STA. 2+700.00		TO STA. 3+050.00		
FED. ROAD DIST. NO. 1		ILLINOIS FED. AID PROJECT		
*(0203.1 & 0304) R-6		CONTRACT # 62105		

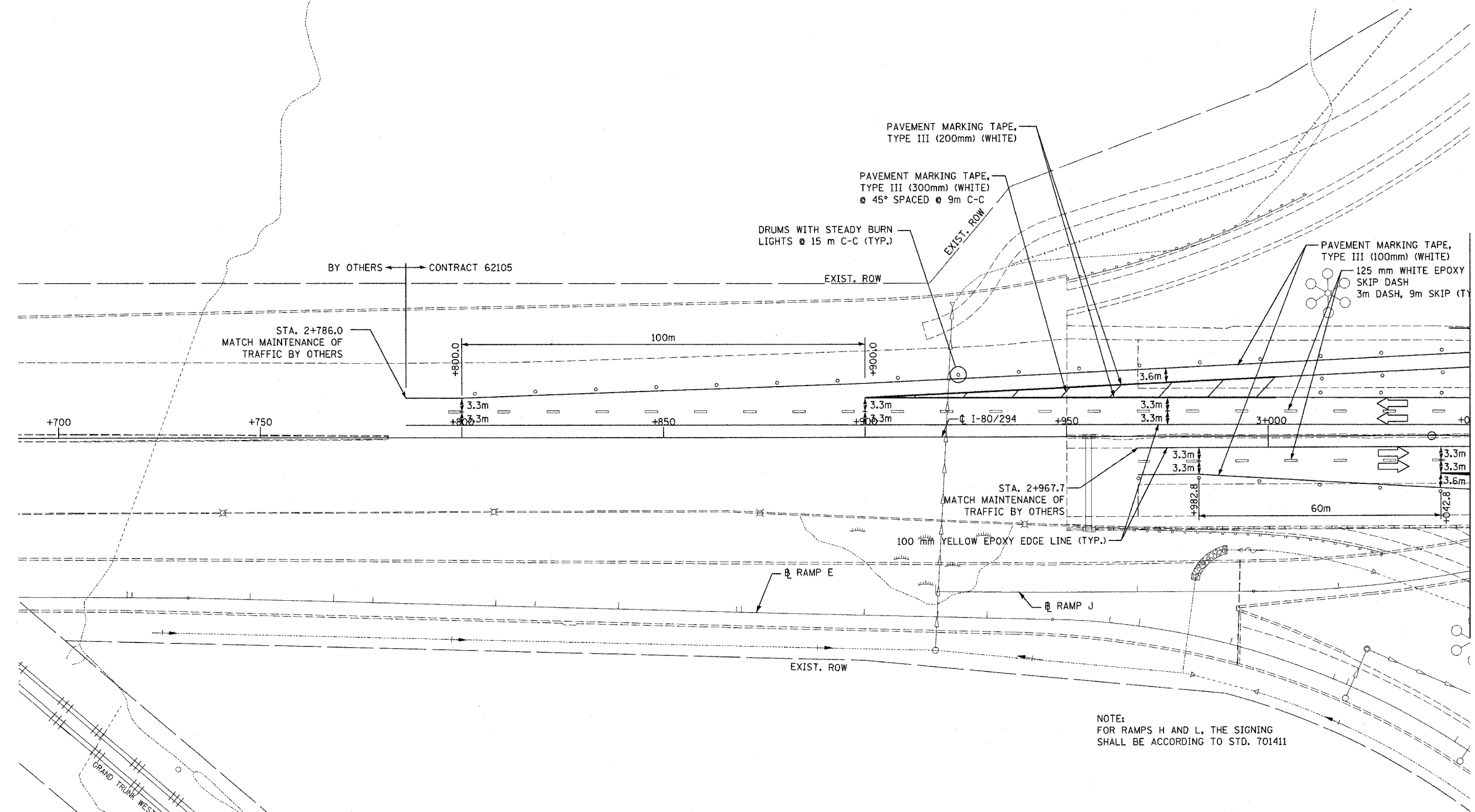

NOTE:
FOR RAMPS H AND L, THE SIGNING
SHALL BE ACCORDING TO STD. 701411



MT-11

LEGEND

	WORK ZONE
	TEMPORARY PAVEMENT (INTERSTATE)

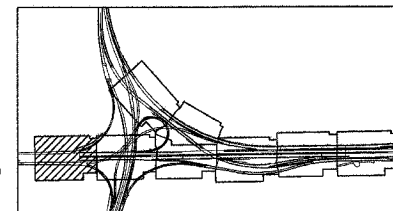

REVISIONS	
NAME	DATE

ILLINOIS DEPARTMENT OF TRANSPORTATION
F.A.I. ROUTE 80/94 (INTERSTATE 80/294)
MAINTENANCE OF TRAFFIC
STAGE 1A
2+700.000 TO 3+050.000 FAI 80/94
DATE: JULY 18, 2005
DRAWN BY: AAS
CHECKED BY: RCH
 McDonough Associates Inc.
Engineers / Architects

F.A.I. RTE.	SECTION	COUNTY	TOTAL SHEETS	SHEET NO.
80/94	*	COOK	231	42
STA. 3+050.00		TO STA. 3+400.00		
FED. ROAD DIST. NO. 1		ILLINOIS FED. AID PROJECT		
*10203.1 & 0304) R-6		CONTRACT # 62105		

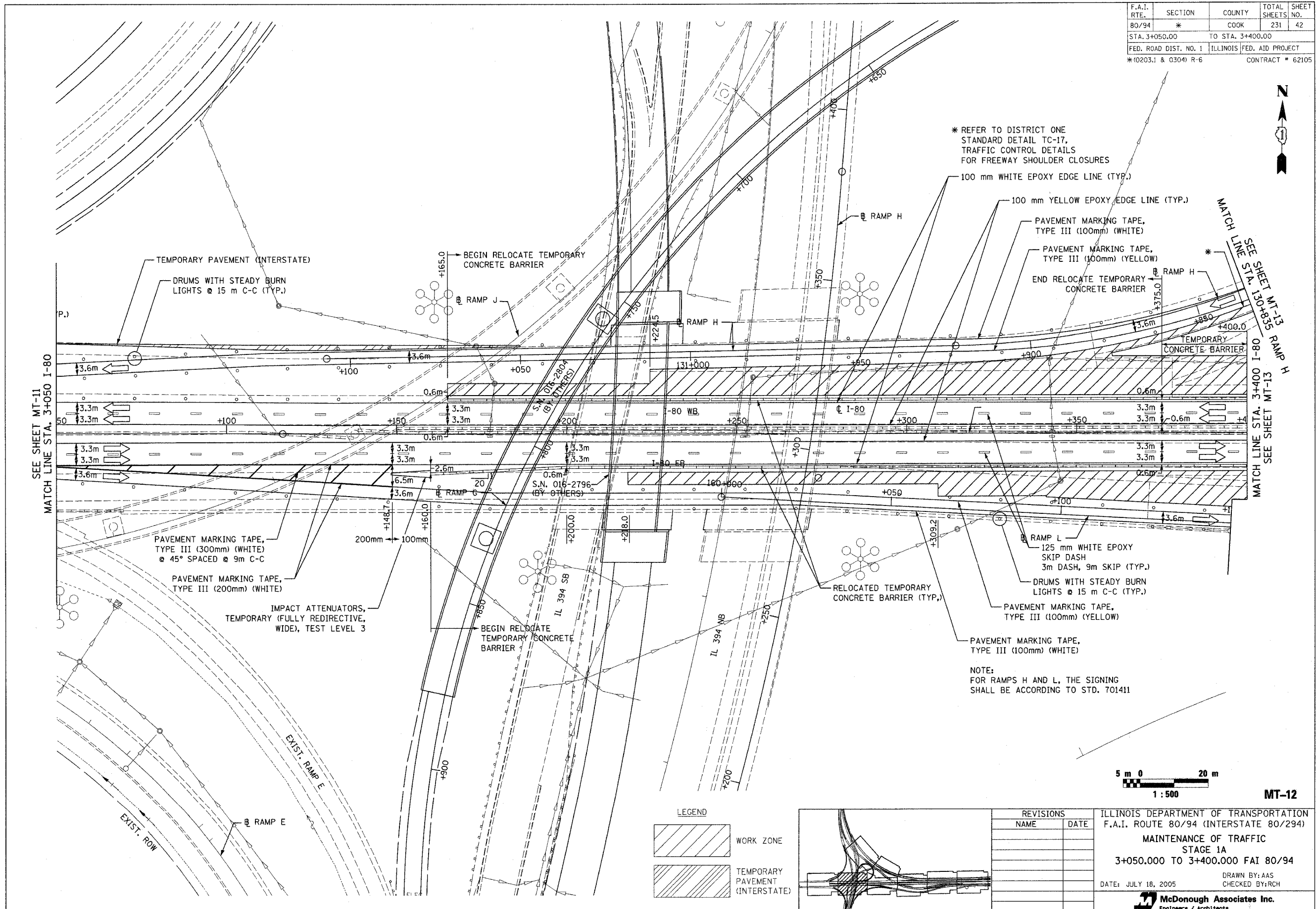

* REFER TO DISTRICT ONE
STANDARD DETAIL TC-17,
TRAFFIC CONTROL DETAILS
FOR FREEWAY SHOULDER CLOSURES

100 mm WHITE EPOXY EDGE LINE (TYP.)

100 mm YELLOW EPOXY EDGE LINE (TYP.)

PAVEMENT MARKING TAPE,
TYPE III (100mm) (WHITE)

PAVEMENT MARKING TAPE,
TYPE III (100mm) (YELLOW)

END RELOCATE TEMPORARY
CONCRETE BARRIER

TEMPORARY
CONCRETE BARRIER

TEMPORARY PAVEMENT (INTERSTATE)

DRUMS WITH STEADY BURN
LIGHTS @ 15 m C-C (TYP.)

BEGIN RELOCATE TEMPORARY
CONCRETE BARRIER

SEE SHEET MT-11
MATCH LINE STA. 3+050 I-80

MATCH LINE SEE SHEET MT-13
STA. 3+400 I-80 RAMP H
SEE SHEET MT-13

PAVEMENT MARKING TAPE,
TYPE III (300mm) (WHITE)
@ 45° SPACED @ 9m C-C

PAVEMENT MARKING TAPE,
TYPE III (200mm) (WHITE)

IMPACT ATTENUATORS,
TEMPORARY (FULLY REDIRECTIVE,
WIDE), TEST LEVEL 3

BEGIN RELOCATE
TEMPORARY CONCRETE
BARRIER

RELOCATED TEMPORARY
CONCRETE BARRIER (TYP.)

RAMP L
125 mm WHITE EPOXY
SKIP DASH
3m DASH, 9m SKIP (TYP.)

DRUMS WITH STEADY BURN
LIGHTS @ 15 m C-C (TYP.)

PAVEMENT MARKING TAPE,
TYPE III (100mm) (YELLOW)

PAVEMENT MARKING TAPE,
TYPE III (100mm) (WHITE)

NOTE:
FOR RAMPS H AND L, THE SIGNING
SHALL BE ACCORDING TO STD. 701411

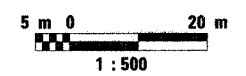

MT-12

LEGEND

- WORK ZONE
- TEMPORARY PAVEMENT (INTERSTATE)

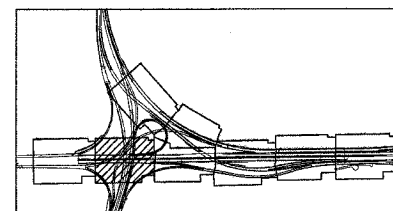

REVISIONS	
NAME	DATE

ILLINOIS DEPARTMENT OF TRANSPORTATION
F.A.I. ROUTE 80/94 (INTERSTATE 80/294)
MAINTENANCE OF TRAFFIC
STAGE 1A
3+050.000 TO 3+400.000 FAI 80/94
DATE: JULY 18, 2005
DRAWN BY: AAS
CHECKED BY: RCH
McDonough Associates Inc.
Engineers / Architects

F.A.I. RTE.	SECTION	COUNTY	TOTAL SHEETS	SHEET NO.
80/94	*	COOK	231	43
STA. 3+400.00		TO STA. 3+750.00		
FED. ROAD DIST. NO. 1		ILLINOIS FED. AID PROJECT		
*10203.1 & 0304 R-6		CONTRACT # 62105		

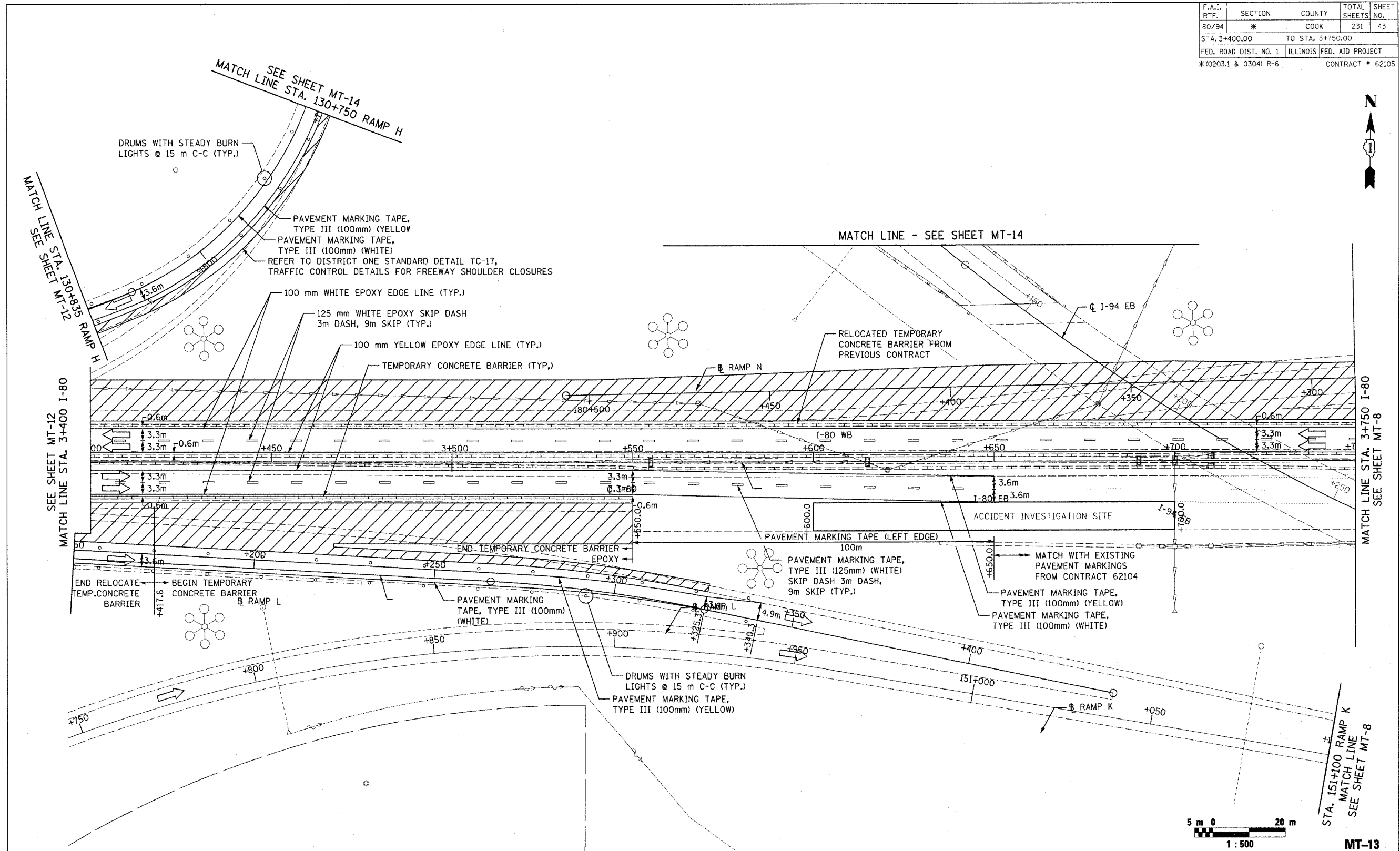

MT-13

LEGEND

	WORK ZONE
	TEMPORARY PAVEMENT (INTERSTATE)

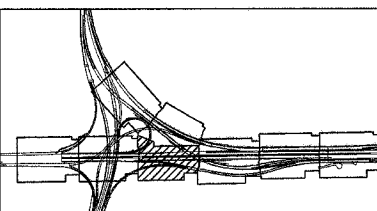

REVISIONS	
NAME	DATE

ILLINOIS DEPARTMENT OF TRANSPORTATION
 F.A.I. ROUTE 80/94 (INTERSTATE 80/294)
 MAINTENANCE OF TRAFFIC
 STAGE 1A
 3+400.000 TO 3+750.000 FAI 80/94
 DATE: JULY 18, 2005
 DRAWN BY: TRK/AAS
 CHECKED BY: RCH
 McDonough Associates Inc.
 Engineers / Architects

F.A.I. RTE.	SECTION	COUNTY	TOTAL SHEETS	SHEET NO.
80/94	*	COOK	231	44
STA. 30+850.00		TO STA. 31+150.00		
FED. ROAD DIST. NO. 1		ILLINOIS FED. AID PROJECT		
*(0203.1 & 0304) R-6		CONTRACT # 62105		

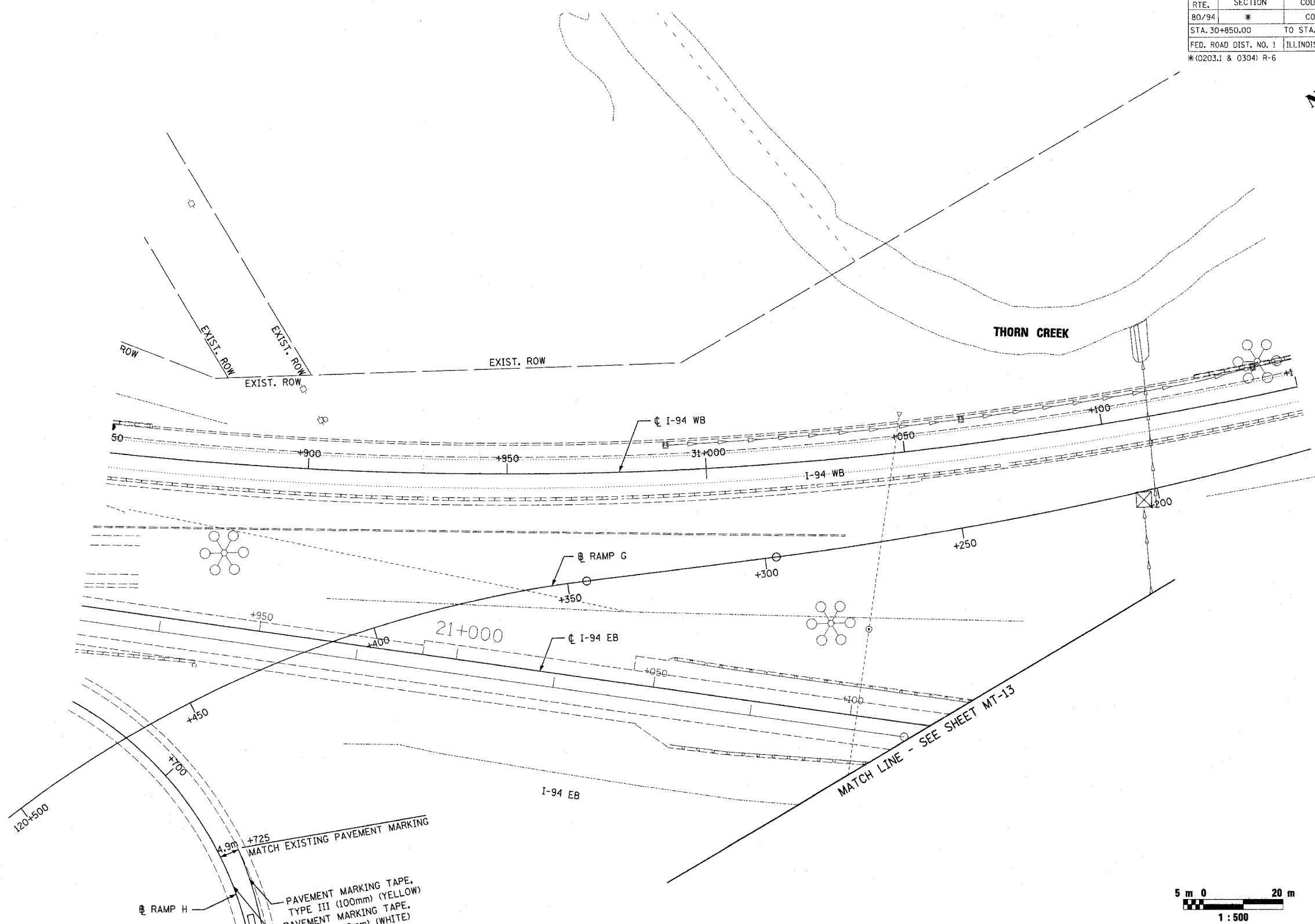
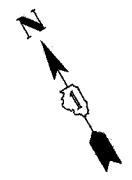

SEE SHEET MT-13
MATCH LINE STA. 130+750 RAMP H

PAVEMENT MARKING TAPE,
TYPE III (100mm) (YELLOW)
PAVEMENT MARKING TAPE,
TYPE III (100mm) (WHITE)

4.9m
MATCH EXISTING PAVEMENT MARKING

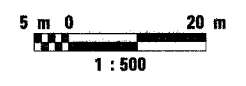

MT-14

LEGEND

	WORK ZONE
	TEMPORARY PAVEMENT (INTERSTATE)

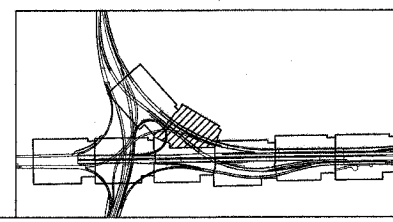

REVISIONS	
NAME	DATE

ILLINOIS DEPARTMENT OF TRANSPORTATION
F.A.I. ROUTE 80/94 (INTERSTATE 80/294)
MAINTENANCE OF TRAFFIC
STAGE 1A
30+850.000 TO 31+150.000 FAI 94 (WB)

DATE: JULY 18, 2005

DRAWN BY: TRK/AAS
CHECKED BY: RCH

McDonough Associates Inc.
Engineers / Architects

F.A.I. RTE.	SECTION	COUNTY	TOTAL SHEETS	SHEET NO.
80/94	*	COOK	231	45
STA. 2+700.00		TO STA. 3+050.00		
FED. ROAD DIST. NO. 1		ILLINOIS FED. AID PROJECT		
*(0203.1 & 0304) R-6		CONTRACT # 62105		

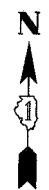

THE CONTRACTOR SHALL COORDINATE WITH THE ADJACENT CONTRACTOR WHEN ORDERING AND INSTALLING THE TEMPORARY BARRIER WALL, WHICH DIVIDES THE I-80 EB AND WB TRAFFIC. THIS WALL SHALL BE THE SAME SHAPE, EITHER NEW JERSEY OR F-SHAPE BARRIER. THE MIXING OF TYPES OF WALL WILL NOT BE PERMITTED.

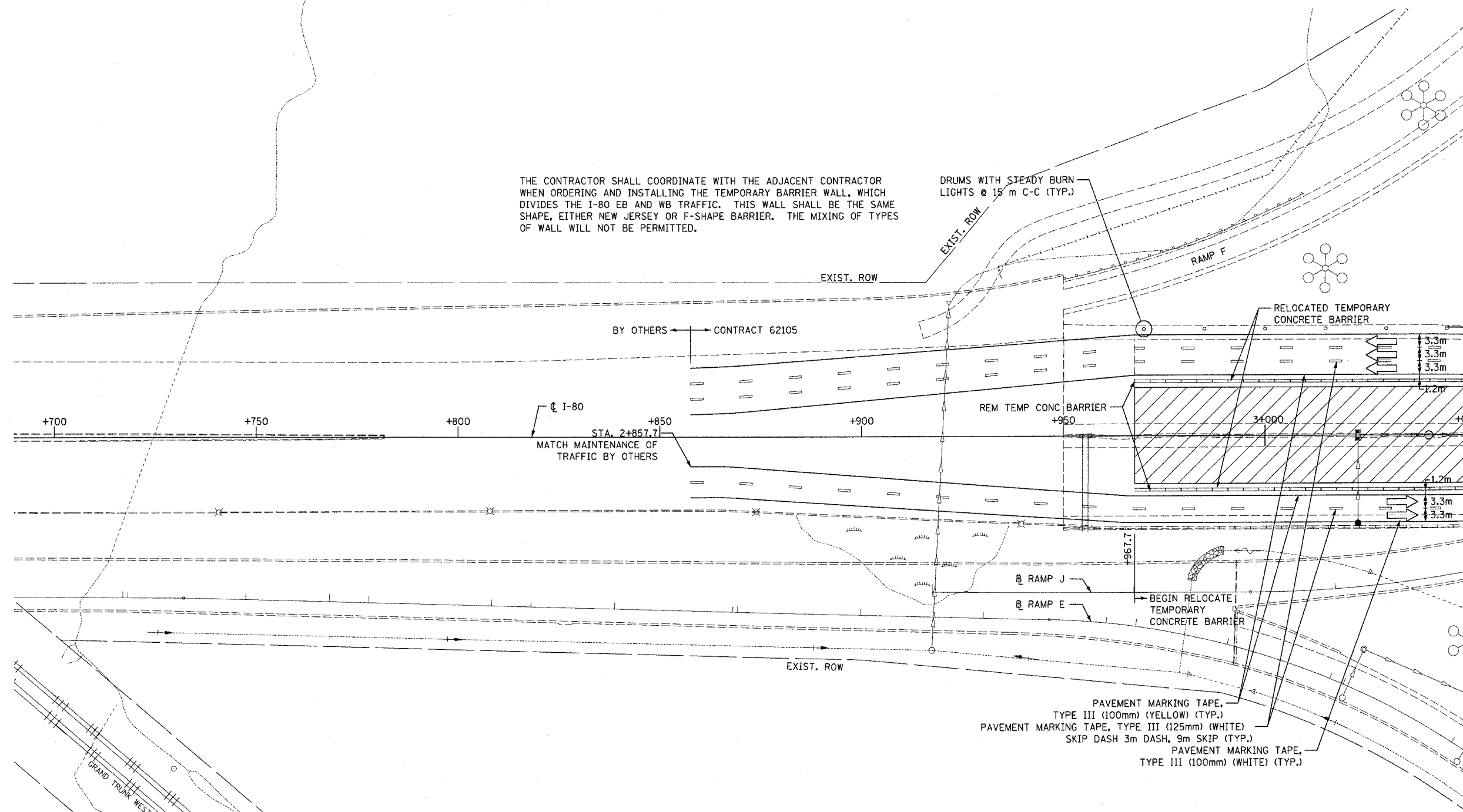

- PAVEMENT MARKING TAPE, TYPE III (100mm) (YELLOW) (TYP.)
- PAVEMENT MARKING TAPE, TYPE III (125mm) (WHITE)
- SKIP DASH 3m DASH, 9m SKIP (TYP.)
- PAVEMENT MARKING TAPE, TYPE III (100mm) (WHITE) (TYP.)



MT-15

LEGEND

	WORK ZONE
	TEMPORARY PAVEMENT (INTERSTATE)

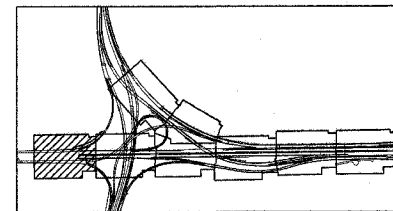

REVISIONS	
NAME	DATE

ILLINOIS DEPARTMENT OF TRANSPORTATION
 F.A.I. ROUTE 80/94 (INTERSTATE 80/294)
 MAINTENANCE OF TRAFFIC
 STAGE 2
 2+700.000 TO 3+050.000 I-80/94
 DATE: JULY 18, 2005
 DRAWN BY: TRK/AAS
 CHECKED BY: RCH
 McDonough Associates Inc.
 Engineers / Architects

F.A.I. RTE.	SECTION	COUNTY	TOTAL SHEETS	SHEET NO.
80/94	*	COOK	231	46
STA. 3+050.00		TO STA. 3+400.00		
FED. ROAD DIST. NO. 1		ILLINOIS FED. AID PROJECT		
*(0203.1 & 0304) R-6		CONTRACT # 62105		

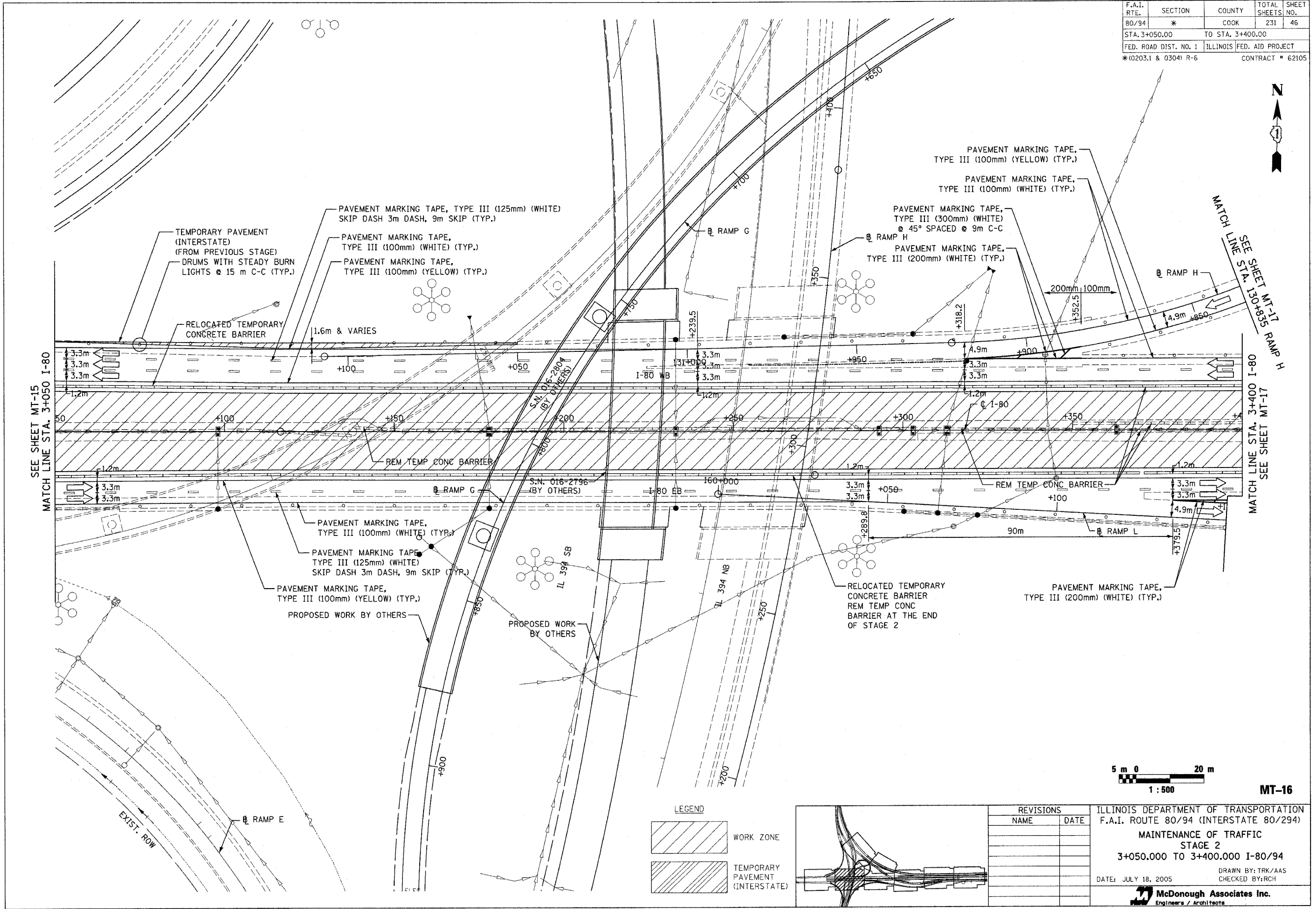

SEE SHEET MT-15
MATCH LINE STA. 3+050 I-80

MATCH LINE SEE SHEET MT-17
STA. 3+400 I-80
RAMP H
MATCH LINE SEE SHEET MT-17



MT-16

LEGEND

- WORK ZONE
- TEMPORARY PAVEMENT (INTERSTATE)

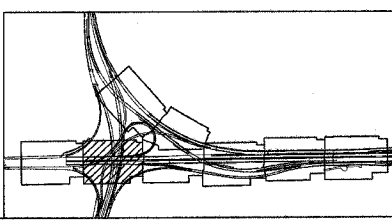

REVISIONS	
NAME	DATE

ILLINOIS DEPARTMENT OF TRANSPORTATION
F.A.I. ROUTE 80/94 (INTERSTATE 80/294)
MAINTENANCE OF TRAFFIC
STAGE 2
3+050.000 TO 3+400.000 I-80/94
DATE: JULY 18, 2005
DRAWN BY: TRK/AAS
CHECKED BY: RCH
McDonough Associates Inc.
Engineers / Architects

F.A.I. RTE.	SECTION	COUNTY	TOTAL SHEETS	SHEET NO.
80/94	*	COOK	231	47
STA. 3+400.00		TO STA. 3+750.00		
FED. ROAD DIST. NO. 1		ILLINOIS FED. AID PROJECT		
*(0203.1 & 0304) R-6		CONTRACT # 62105		

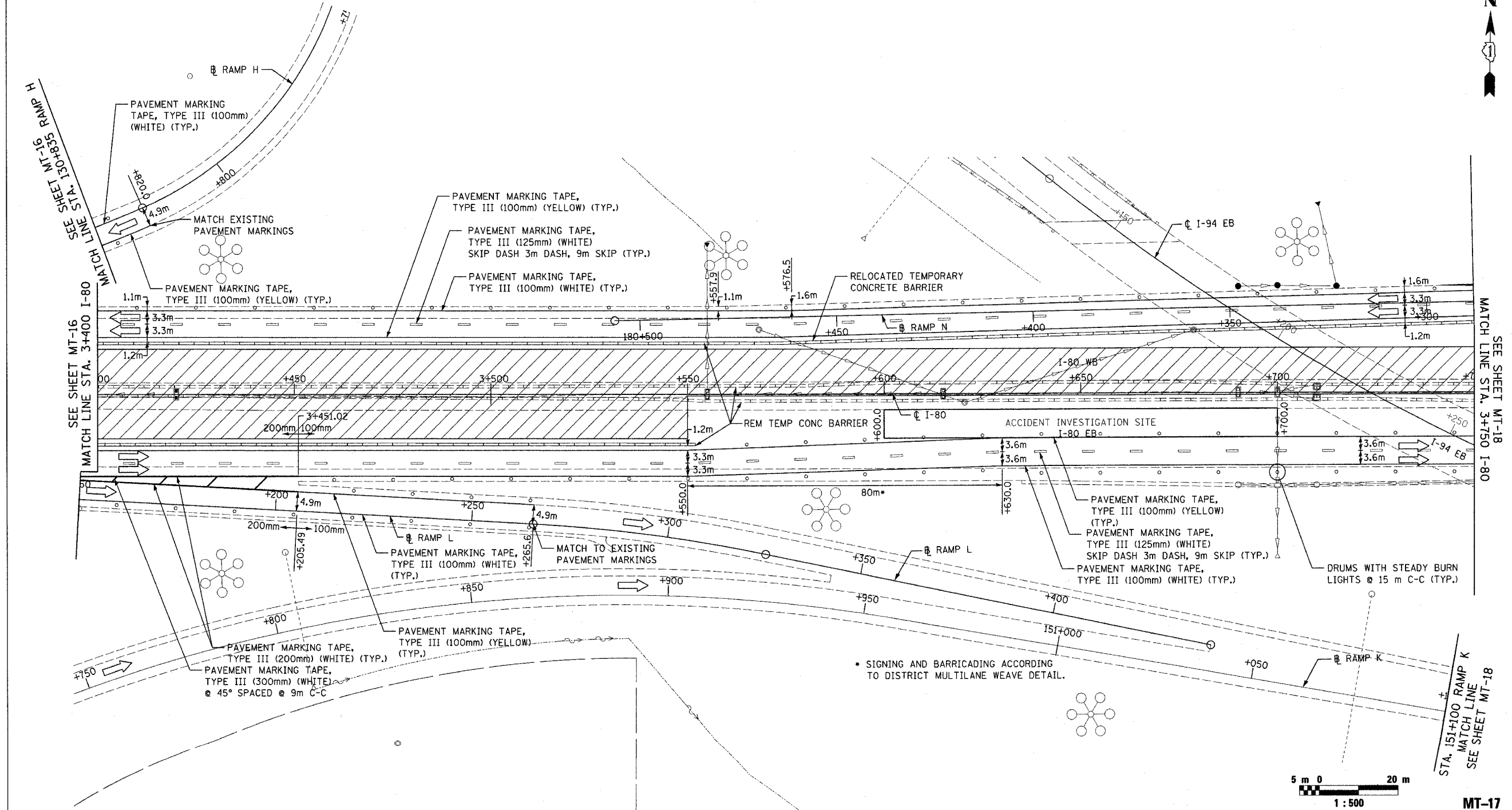

• SIGNING AND BARRICADING ACCORDING TO DISTRICT MULTILANE WEAVE DETAIL.



MT-17

LEGEND

	WORK ZONE
	TEMPORARY PAVEMENT (INTERSTATE)

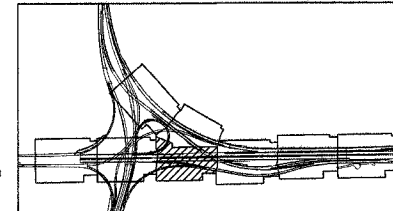

REVISIONS	
NAME	DATE

ILLINOIS DEPARTMENT OF TRANSPORTATION
 F.A.I. ROUTE 80/94 (INTERSTATE 80/294)
 MAINTENANCE OF TRAFFIC
 STAGE 2
 3+400.000 TO 3+750.000 FAI 80/94
 DATE: JULY 18, 2005
 DRAWN BY: TRK/AAS
 CHECKED BY: RCH
 McDonough Associates Inc.
 Engineers / Architects

F.A.I. RTE.	SECTION	COUNTY	TOTAL SHEETS	SHEET NO.
80/94	*	COOK	231	48
STA. 3+750.00		TO STA. 4+100.00		
FED. ROAD DIST. NO. 1		ILLINOIS FED. AID PROJECT		
*10203.1 & 0304) R-6		CONTRACT # 62105		

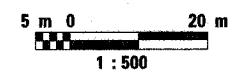
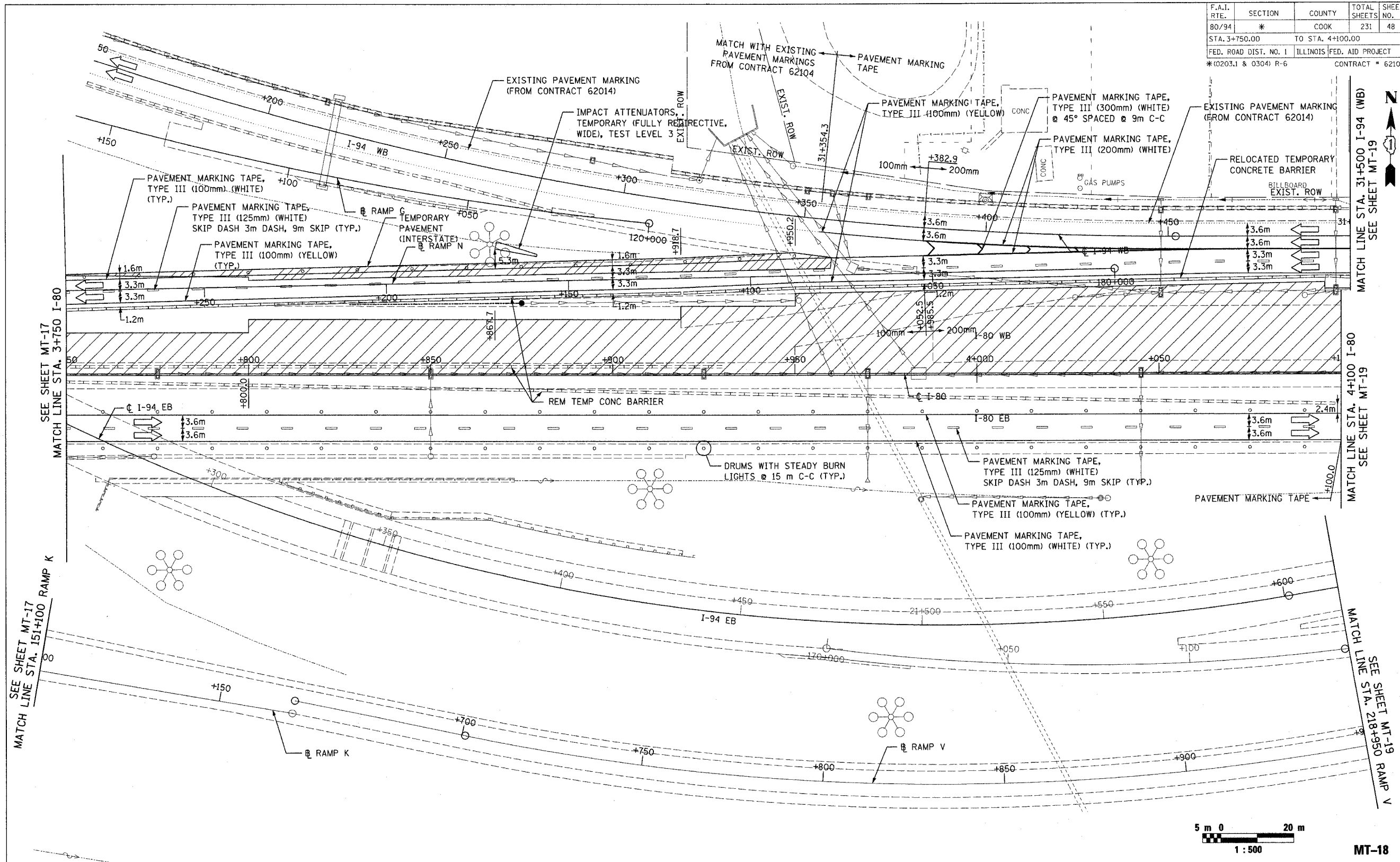

MT-18

LEGEND

	WORK ZONE
	TEMPORARY PAVEMENT (INTERSTATE)

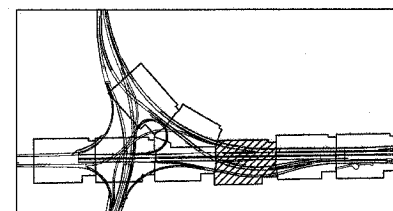

REVISIONS	
NAME	DATE

ILLINOIS DEPARTMENT OF TRANSPORTATION
F.A.I. ROUTE 80/94 (INTERSTATE 80/294)
MAINTENANCE OF TRAFFIC
STAGE 2
3+750.000 TO 4+100.000 FAI 80/94
DATE: JULY 18, 2005
DRAWN BY: TRK/AAS
CHECKED BY: RCH
McDonough Associates Inc.
Engineers / Architects

F.A.I. RTE.	SECTION	COUNTY	TOTAL SHEETS	SHEET NO.
80/94	*	COOK	231	49
STA. 4+100.00		TO STA. 4+450.00		
FED. ROAD DIST. NO. 1		ILLINOIS FED. AID PROJECT		
*(0203.1 & 0304) R-6		CONTRACT # 62105		

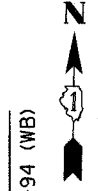
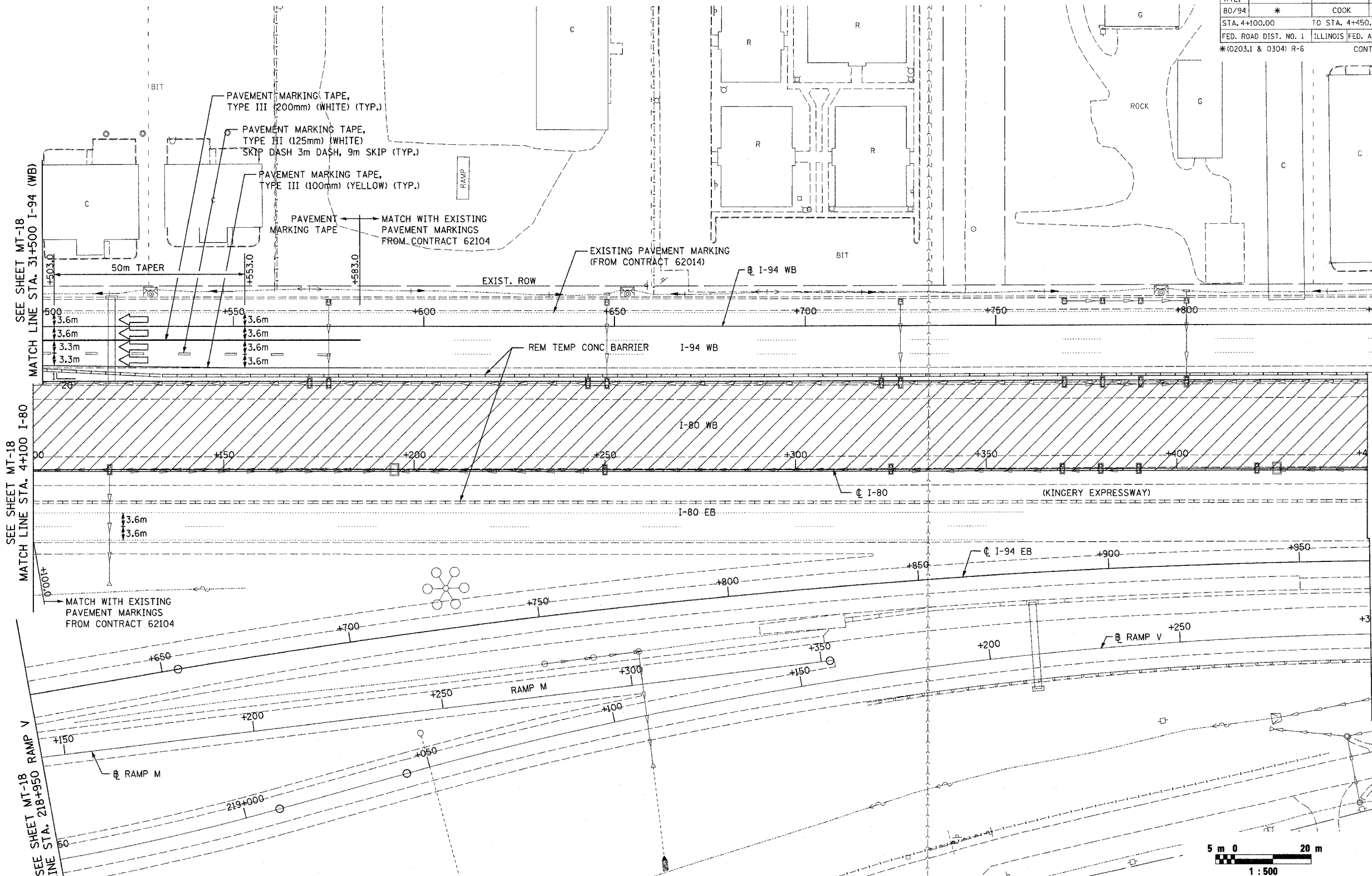

SEE SHEET MT-18
MATCH LINE STA. 31+500 I-94 (WB)

SEE SHEET MT-18
MATCH LINE STA. 4+100 I-80

SEE SHEET MT-18
MATCH LINE STA. 218+950 RAMP V

MATCH LINE STA. 31+850 I-94 (WB)
SEE SHEET MT-20

MATCH LINE STA. 4+450 I-80
SEE SHEET MT-20



MT-19

LEGEND

	WORK ZONE
	TEMPORARY PAVEMENT (INTERSTATE)

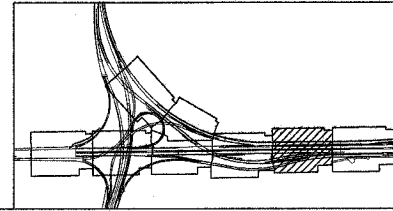

REVISIONS	
NAME	DATE

ILLINOIS DEPARTMENT OF TRANSPORTATION
F.A.I. ROUTE 80/94 (INTERSTATE 80/294)
MAINTENANCE OF TRAFFIC
STAGE 2
4+100.000 TO 4+450.000 FAI 80/94
DATE: JULY 18, 2005
DRAWN BY: TRK/AAS
CHECKED BY: RCH
McDonough Associates Inc.
Engineers / Architects

F.A.I. RTE.	SECTION	COUNTY	TOTAL SHEETS	SHEET NO.
80/94	*	COOK	231	50
STA. 4+450.00		TO STA. 4+800.00		
FED. ROAD DIST. NO. 1		ILLINOIS FED. AID PROJECT		
*(0203.1 & 0304) R-6		CONTRACT # 62105		

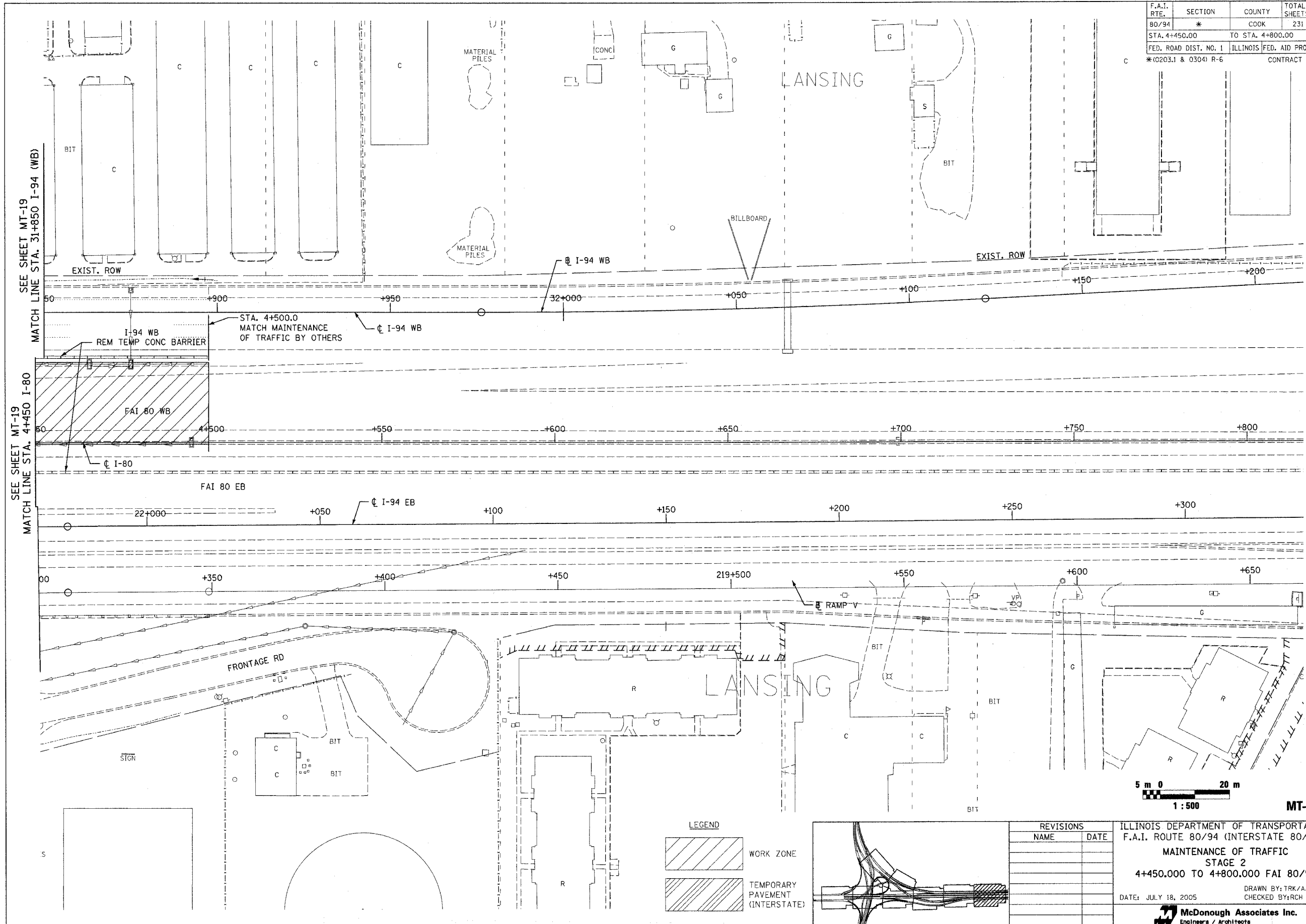

MT-20

LEGEND

	WORK ZONE
	TEMPORARY PAVEMENT (INTERSTATE)

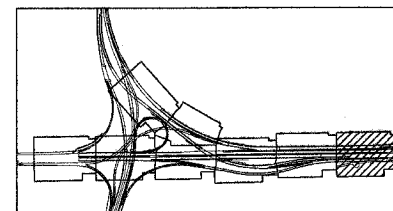

REVISIONS	
NAME	DATE

ILLINOIS DEPARTMENT OF TRANSPORTATION
 F.A.I. ROUTE 80/94 (INTERSTATE 80/294)
 MAINTENANCE OF TRAFFIC
 STAGE 2
 4+450.000 TO 4+800.000 FAI 80/94
 DATE: JULY 18, 2005
 DRAWN BY: TRK/AAS
 CHECKED BY: RCH
 McDonough Associates Inc.
 Engineers / Architects

F.A.I. RTE.	SECTION	COUNTY	TOTAL SHEETS	SHEET NO.
80/94	*	COOK	231	51
STA.		TO STA.		
FED. ROAD DIST. NO. 1		ILLINOIS	FED. AID PROJECT	
*(0203.1 & 0304) R-6		CONTRACT # 62105		

APPENDIX D
BORING LOCATION PLANS
AND SOIL PROFILES

REPORT
GEOTECHNICAL INVESTIGATION
SOIL SURVEY
CONTRACT 16 (62105)
EASTBOUND AND WESTBOUND
I-80 MAINLINE AND RAMP N
IDOT PROJECT NO. D-91-018-01
FAI 80 (INTERSTATE 80/94)
FROM I-294 TO US RTE. 41
COOK COUNTY, ILLINOIS

FOR
AMERICAN CONSULTANT ENGINEERS, LLC.
5440 N. CUMBERLAND AVENUE, SUITE 111
CHICAGO, ILLINOIS 60656

Prepared by:
WANG ENGINEERING, INC.
1145 N. MAIN STREET
LOMBARD, IL 60148

DATE: AUGUST 9, 2004

Signed _____

Date _____

LEGEND

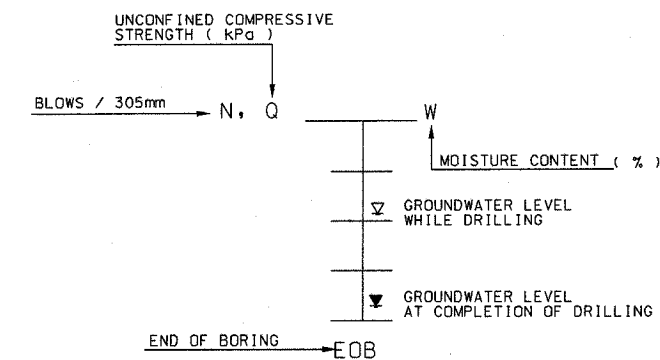
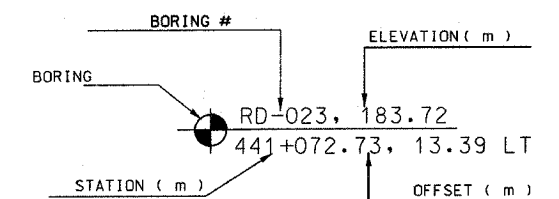

WEI NO. 255-08-04

F.A.I. 80/94 (KINGERY EXPRESSWAY) BORING LOCATION	F.A.I. RTE.	SECTION	COUNTY	TOTAL SHEETS	SHEET NO.
ILLINOIS DEPARTMENT OF TRANSPORTATION, COOK COUNTY	80/94	*	COOK	231	52
HORIZ SCALE: 1:500 VERT SCALE: 1:100	DRAWN BY: M.S. CHECKED BY: L.L.	STA. 2+700.00 TO STA. 3+400.00			
Wang Engineering, Inc. 1145 Main Street Lombard, IL 60148 630-953-9228		FED. ROAD DIST. NO. 1		ILLINOIS FED. AID PROJECT	CONTRACT # 62105
BASED ON DRAWINGS PREPARED BY MADONOUGH AND ASSOCIATES, INC. 255-08-04 * (02)3.1 & (03)4) R-6					

FINAL SURVEYED	BY	DATE
SURVEY PLOTTED		
NOTE BOOK TEMPLATE		
AREAS CHECKED		
NO.		

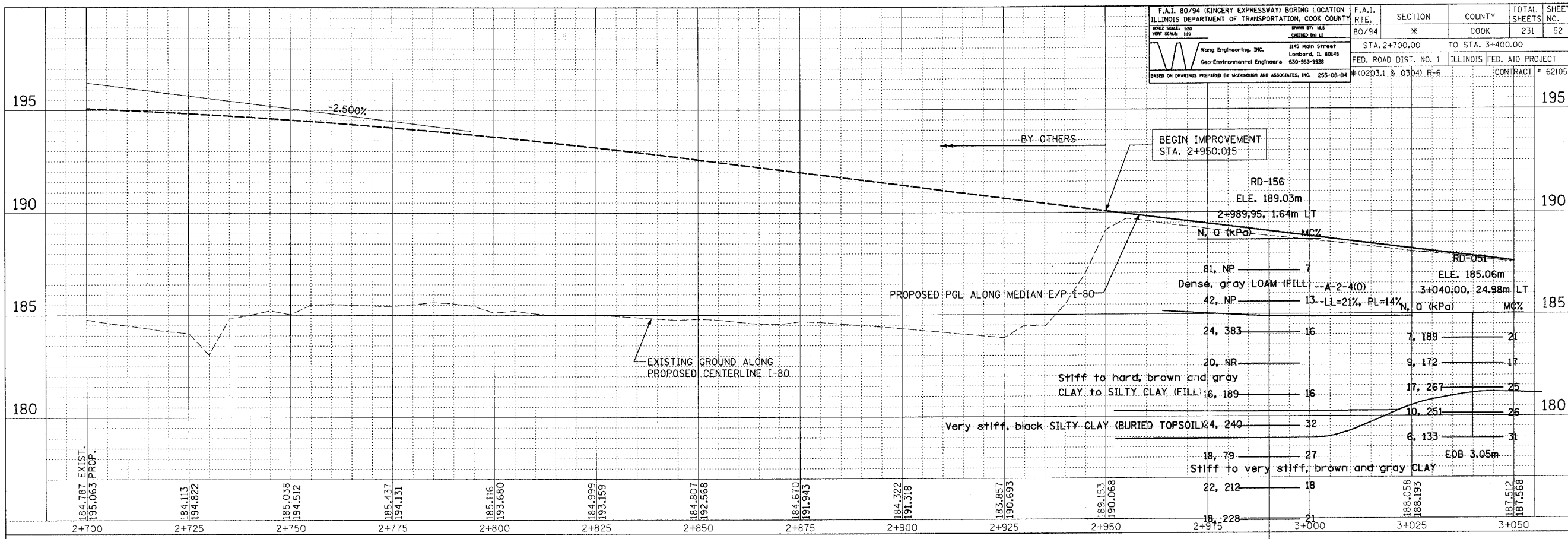

ORIGINAL SURVEYED	BY	DATE
SURVEY PLOTTED		
NOTE BOOK TEMPLATE		
AREAS CHECKED		
NO.		

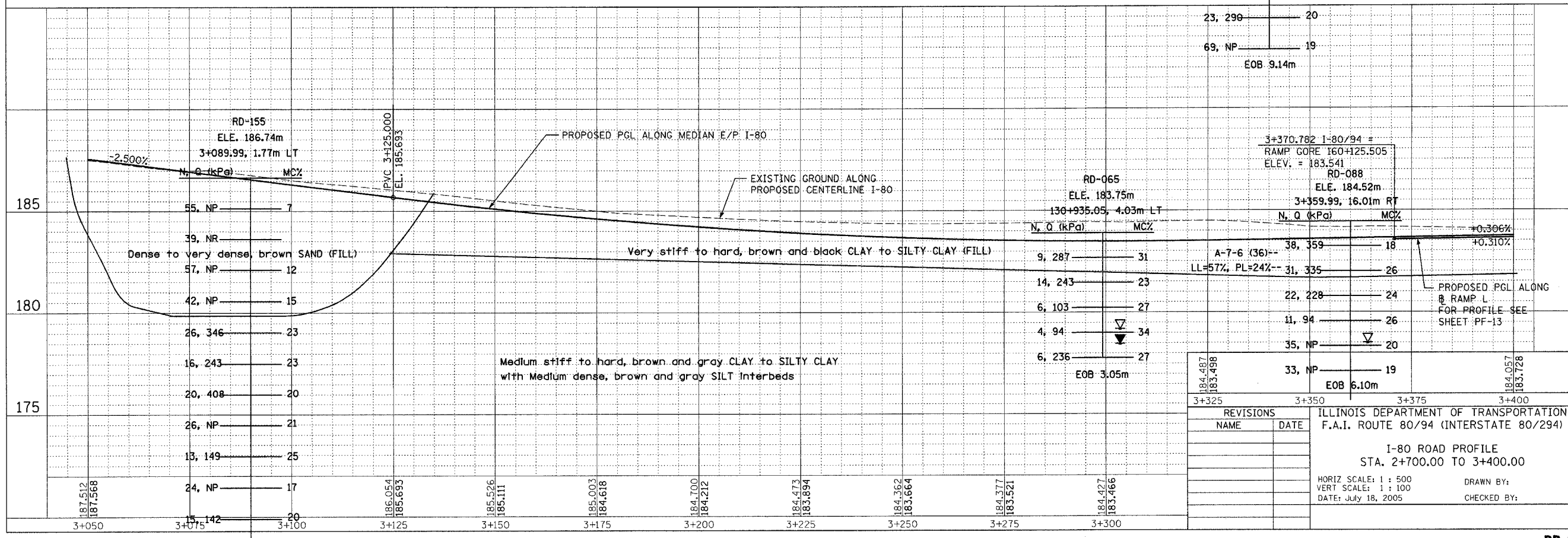

REVISIONS	ILLINOIS DEPARTMENT OF TRANSPORTATION
NAME	F.A.I. ROUTE 80/94 (INTERSTATE 80/294)
DATE	
	I-80 ROAD PROFILE
	STA. 2+700.00 TO 3+400.00
	HORIZ SCALE: 1 : 500
	VERT SCALE: 1 : 100
	DATE: July 18, 2005
	DRAWN BY:
	CHECKED BY:

18, 189 EOB 9.14m 21

F.A.I. 80/94 (KINGERY EXPRESSWAY) BORING LOCATION	F.A.I. RTE.	SECTION	COUNTY	TOTAL SHEETS	SHEET NO.
ILLINOIS DEPARTMENT OF TRANSPORTATION, COOK COUNTY	80/94	*	COOK	231	53
DATE: 8/11/05	STA. 2+700.00	TO STA. 3+050.00			
Wang Engineering, Inc. 1145 Main Street Lombard, IL 60148 Geo-Environmental Engineers 630-953-9228	FED. ROAD DIST. NO. 1	ILLINOIS FED. AID PROJECT			
BASED ON DRAWINGS PREPARED BY MADDOUGH AND ASSOCIATES, INC. 255-08-04	* (0203.1 & 0304) R-6		CONTRACT # 62105		

LEGEND
 PAVEMENT REMOVAL
 SHOULDER REMOVAL

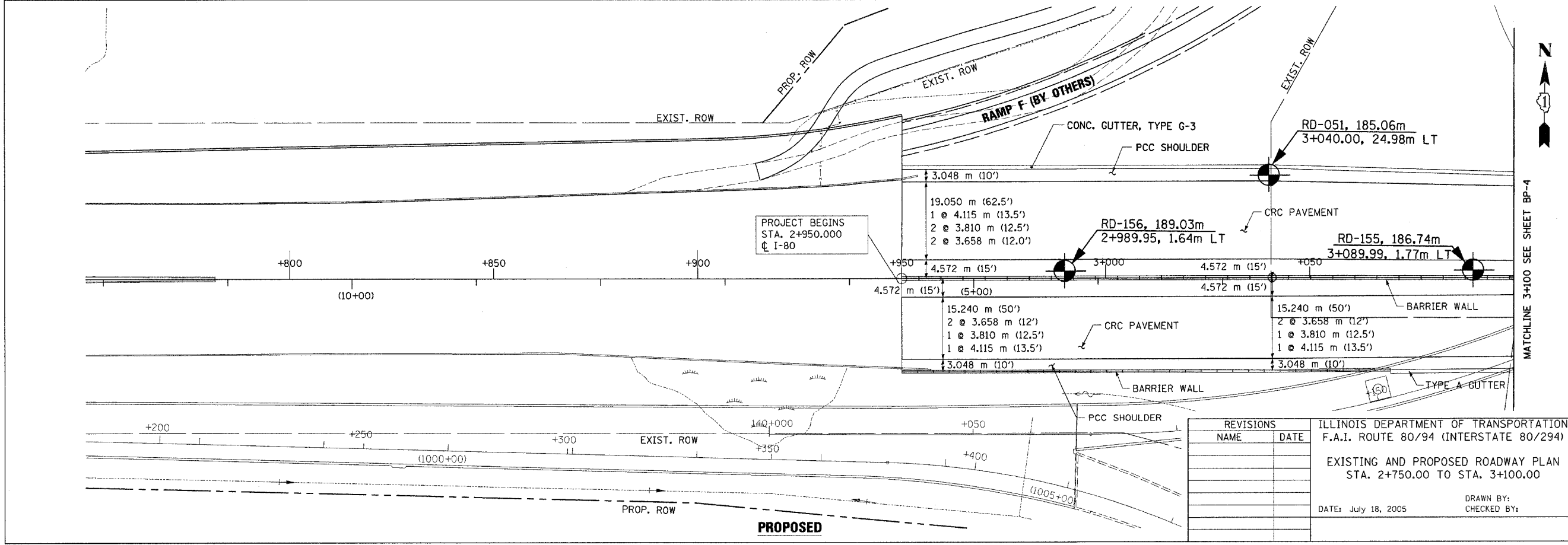
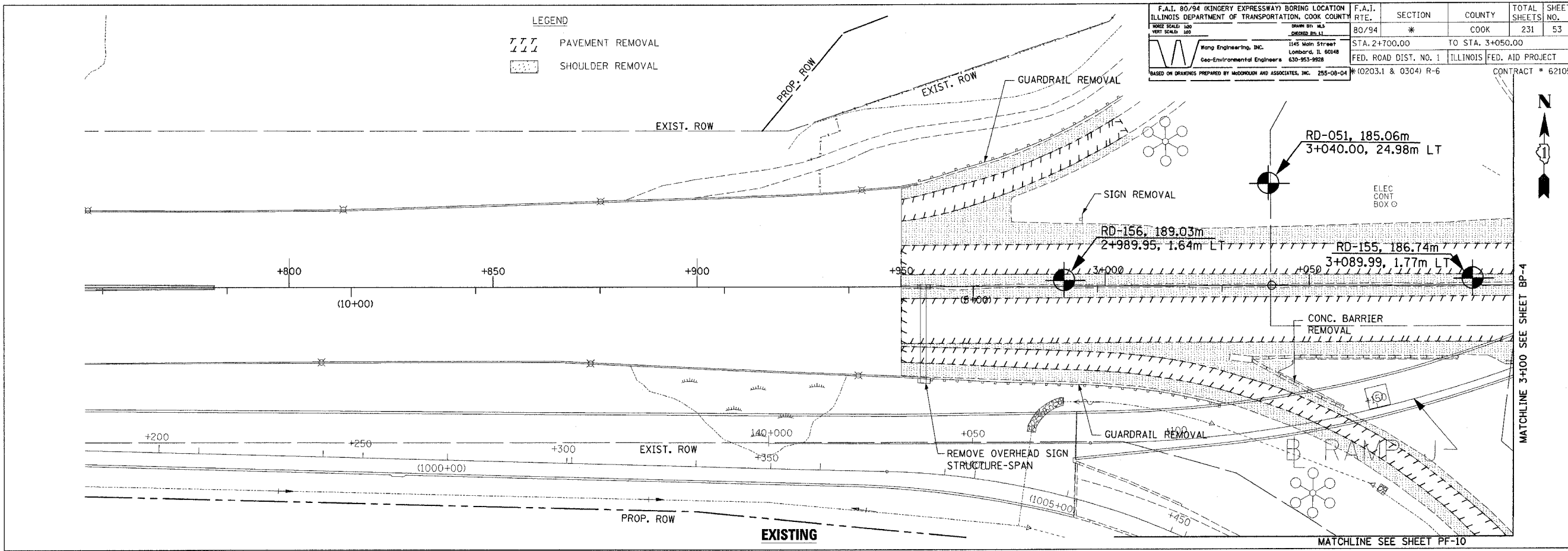

REVISIONS		ILLINOIS DEPARTMENT OF TRANSPORTATION F.A.I. ROUTE 80/94 (INTERSTATE 80/294) EXISTING AND PROPOSED ROADWAY PLAN STA. 2+750.00 TO STA. 3+100.00
NAME	DATE	
		DATE: July 18, 2005
		DRAWN BY: _____
		CHECKED BY: _____

F.A.I. 80/94 (KINGERY EXPRESSWAY) BORING LOCATION	F.A.I. RTE.	SECTION	COUNTY	TOTAL SHEETS	SHEET NO.
ILLINOIS DEPARTMENT OF TRANSPORTATION, COOK COUNTY	80/94	*	COOK	231	54
HORIZ SCALE: 1:500 VERT SCALE: 1:100	STA. 3+050.00	TO STA. 3+400.00	FED. ROAD DIST. NO. 1	ILLINOIS FED. AID PROJECT	CONTRACT # 62105
DRAWN BY: W.S. [Signature] CHECKED BY: [Signature] Wang Engineering, Inc. 1145 Main Street Lombard, IL 60148 630-953-9928 Geo-Environmental Engineers BASED ON DRAWINGS PREPARED BY McDONOUGH AND ASSOCIATES, INC. 256-08-04					

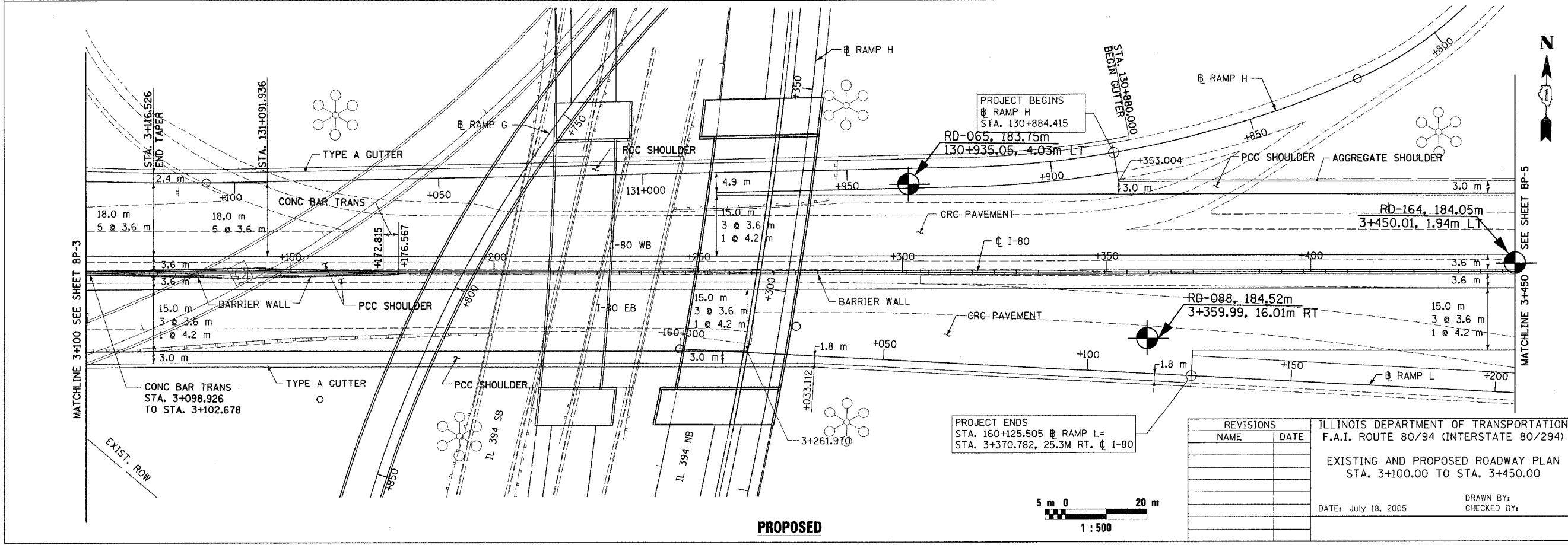
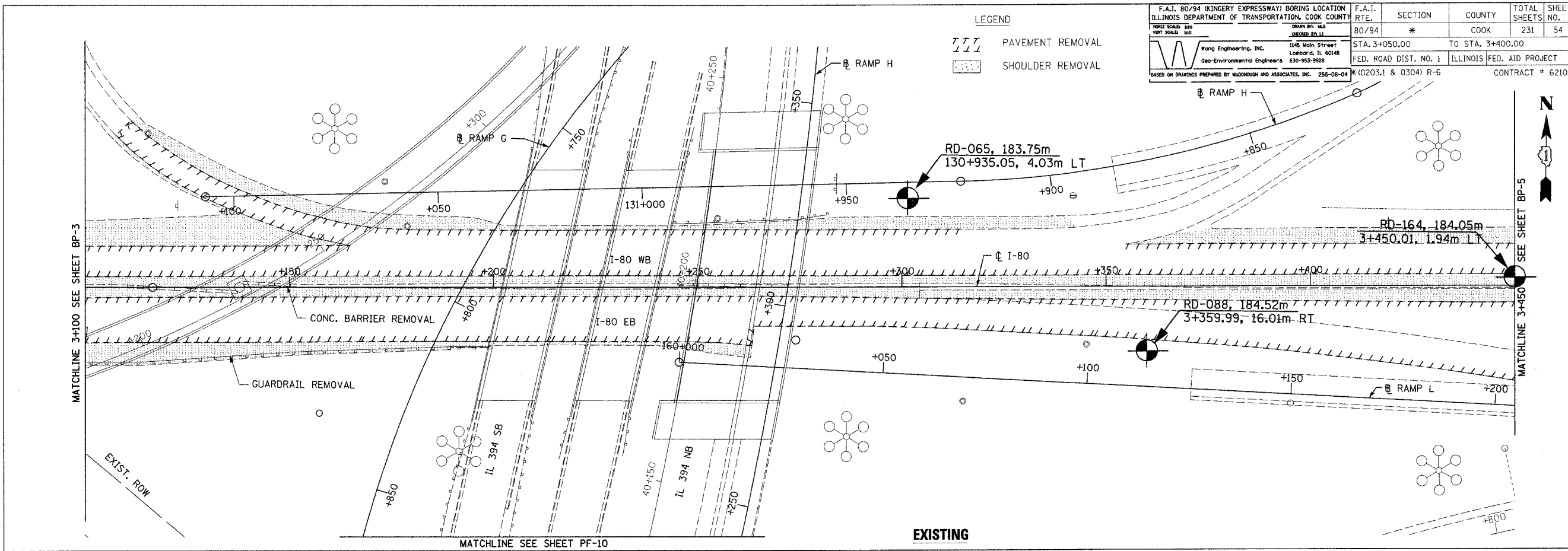

REVISIONS	
NAME	DATE

ILLINOIS DEPARTMENT OF TRANSPORTATION
F.A.I. ROUTE 80/94 (INTERSTATE 80/294)

EXISTING AND PROPOSED ROADWAY PLAN
STA. 3+100.00 TO STA. 3+450.00

DATE: July 18, 2005 DRAWN BY: [Signature]
CHECKED BY: [Signature]

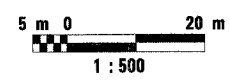

F.A.I. 80/94 (KINGERY EXPRESSWAY) BORING LOCATION ILLINOIS DEPARTMENT OF TRANSPORTATION, COOK COUNTY		F.A.I. RTE.	SECTION	COUNTY	TOTAL SHEETS	SHEET NO.
HORIZ SCALE: 1:500 VERT SCALE: 1:100		80/94	*	COOK	231	55
Wang Engineering, Inc. Geo-Environmental Engineers 1145 Main Street Lombard, IL 60148 630-953-9928		STA. 3+400.00 TO STA. 4+100.00		ILLINOIS FED. AID PROJECT		CONTRACT # 62105
BASED ON DRAWINGS PREPARED BY McDONOUGH AND ASSOCIATES, INC. 255-08-04		* (0203.1 & 0304) R-6				

BY	DATE
FINAL SURVEYED	
SURVEY PLOTTED	
NOTE BOOK TEMPLATE	
AREAS CHECKED	
NO.	

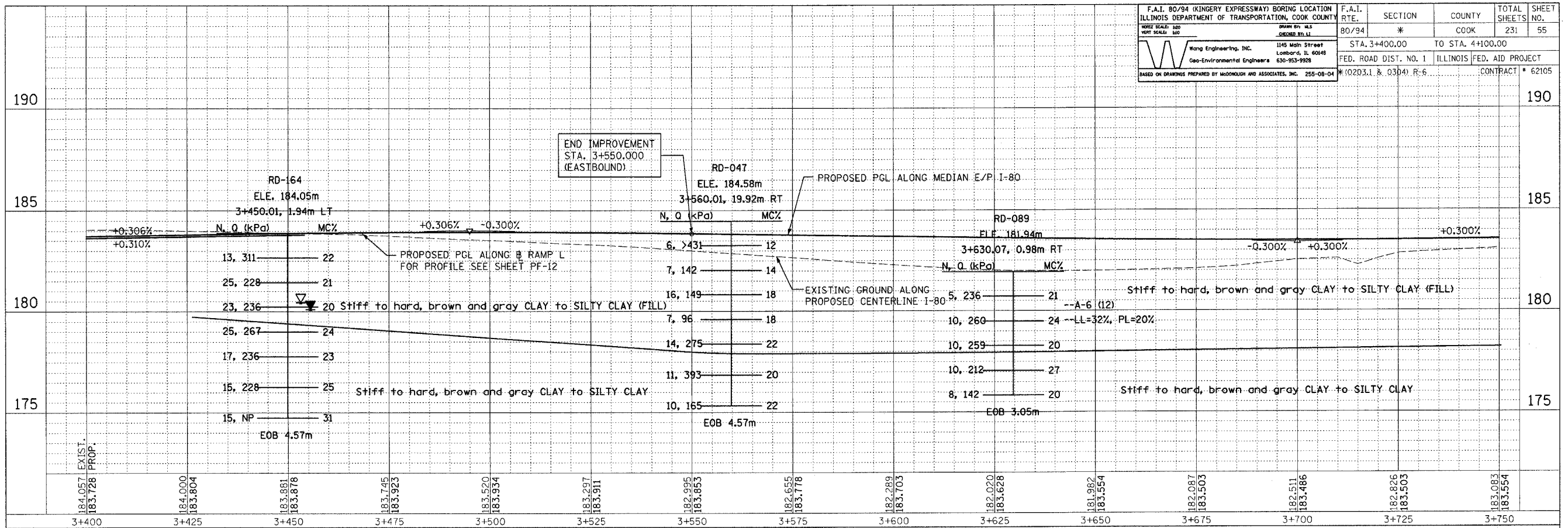

BY	DATE
ORIGINAL SURVEYED	
SURVEY PLOTTED	
NOTE BOOK TEMPLATE	
AREAS CHECKED	
NO.	

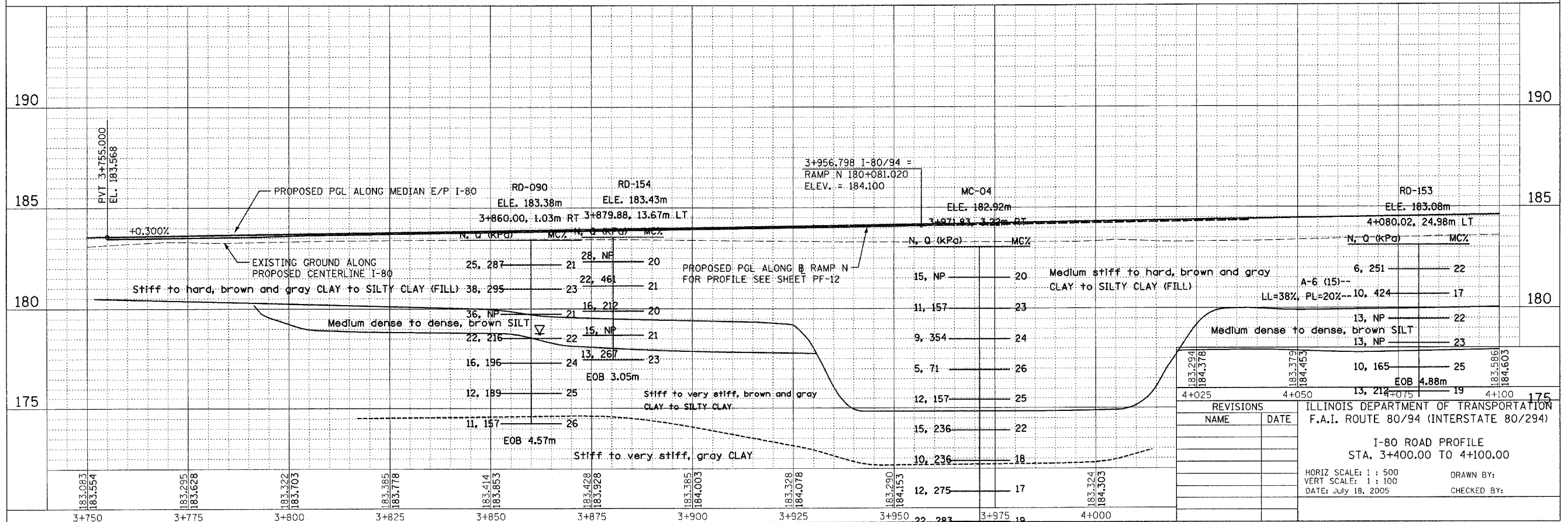

REVISIONS	NAME	DATE

ILLINOIS DEPARTMENT OF TRANSPORTATION
F.A.I. ROUTE 80/94 (INTERSTATE 80/294)

I-80 ROAD PROFILE
STA. 3+400.00 TO 4+100.00

HORIZ SCALE: 1 : 500
VERT SCALE: 1 : 100
DATE: July 18, 2005

DRAWN BY:
CHECKED BY:

F.A.I. 80/94 (KINGERY EXPRESSWAY) BORING LOCATION	F.A.I. SECTION	COUNTY	TOTAL SHEETS	SHEET NO.
ILLINOIS DEPARTMENT OF TRANSPORTATION, COOK COUNTY	80/94	COOK	231	56
HORIZ SCALE: 1"=100'	VERT SCALE: 1"=10'	DRAWN BY: M.S. DREWED BY: L.L.		
Wong Engineering, Inc. 1145 Main Street Lombard, IL 60148 630-953-9928		STA. 3+400.00 TO STA. 3+750.00		
BASED ON DRAWINGS PREPARED BY McDONOUGH AND ASSOCIATES, INC. 255-08-04		FED. ROAD DIST. NO. 1 ILLINOIS FED. AID PROJECT		
		CONTRACT # 62105		

LEGEND
 PAVEMENT REMOVAL
 SHOULDER REMOVAL

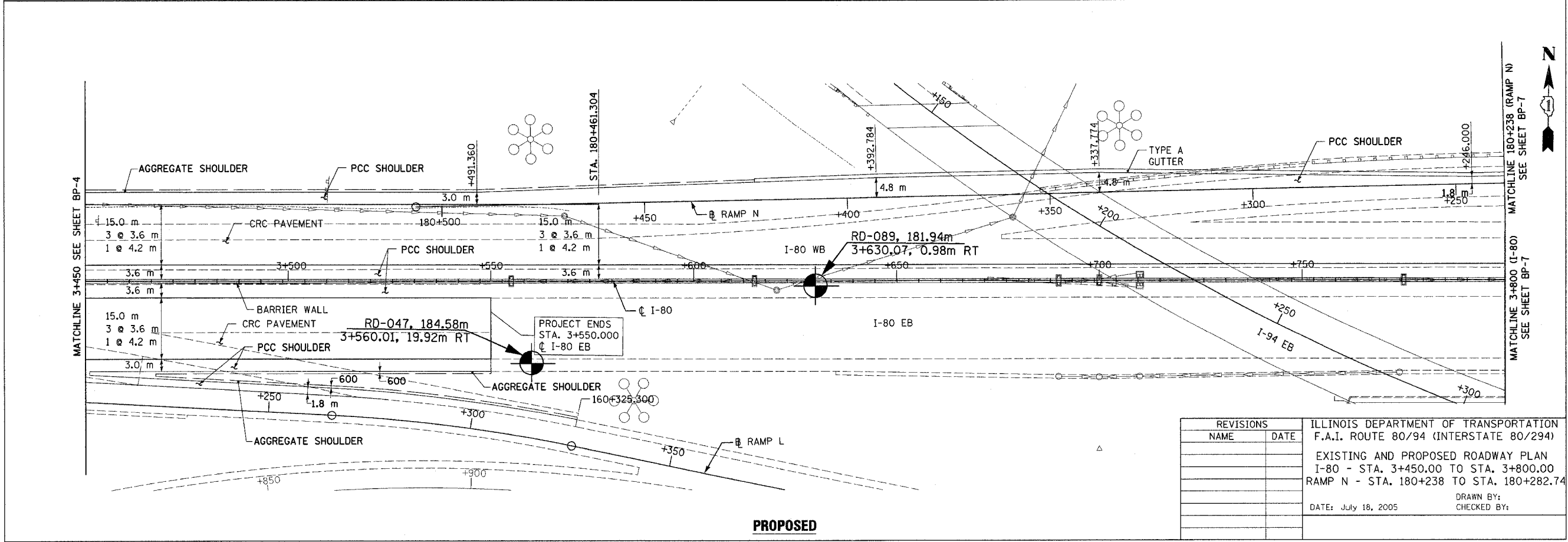
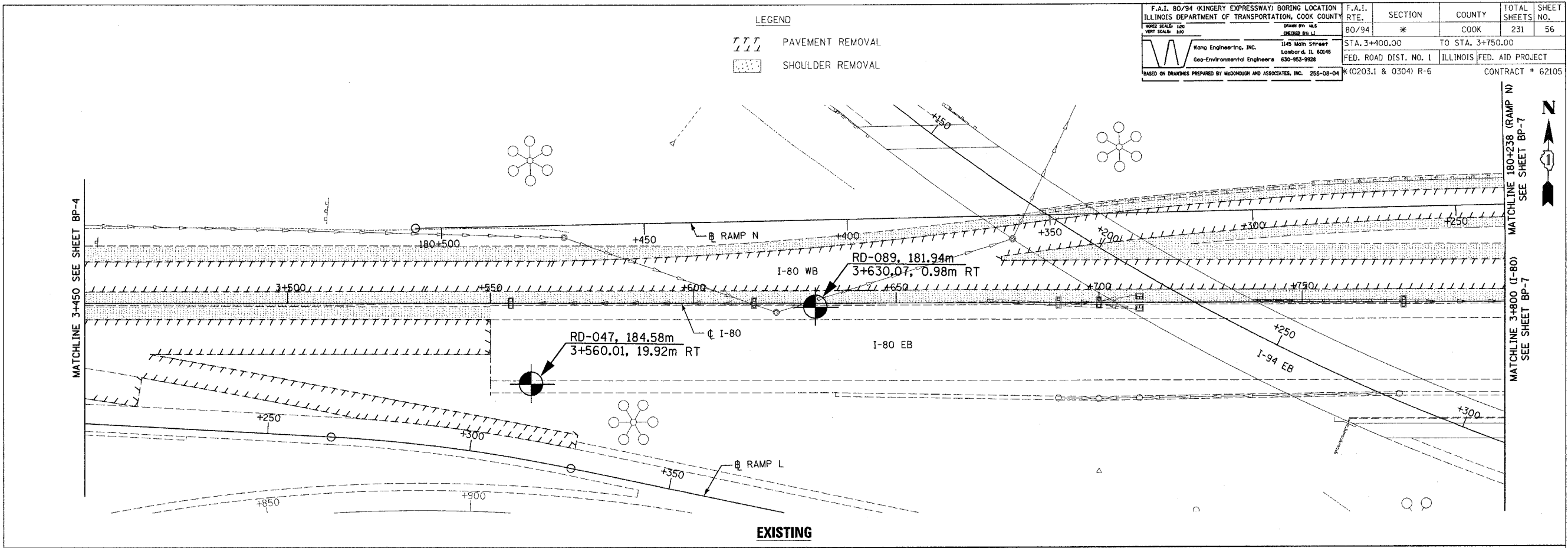

REVISIONS		ILLINOIS DEPARTMENT OF TRANSPORTATION F.A.I. ROUTE 80/94 (INTERSTATE 80/294)
NAME	DATE	
		EXISTING AND PROPOSED ROADWAY PLAN I-80 - STA. 3+450.00 TO STA. 3+800.00 RAMP N - STA. 180+238 TO STA. 180+282.74 DATE: July 18, 2005 DRAWN BY: _____ CHECKED BY: _____

...Phase3/Contract: I80BP-6.dgn 7/15/2005 11:36:51 AM

F.A.I. 80/94 (KINGERY EXPRESSWAY) BORING LOCATION	F.A.I. RTE.	SECTION	COUNTY	TOTAL SHEETS	SHEET NO.
ILLINOIS DEPARTMENT OF TRANSPORTATION, COOK COUNTY	80/94	*	COOK	231	57
HORIZ SCALE: 1"=100'	DRAWN BY: M.S.		CHECKED BY: L.L.		
VERT SCALE: 1"=10'	Wang Engineering, Inc.		1145 Main Street Lombard, IL 60148 630-953-9928		
Geo-Environmental Engineers		STA. 3+750.00		TO STA. 4+100.00	
BASED ON DRAWINGS PREPARED BY McDONOUGH AND ASSOCIATES, INC. 255-08-04		FED. ROAD DIST. NO. 1		ILLINOIS FED. AID PROJECT	
		R-6		CONTRACT # 62105	

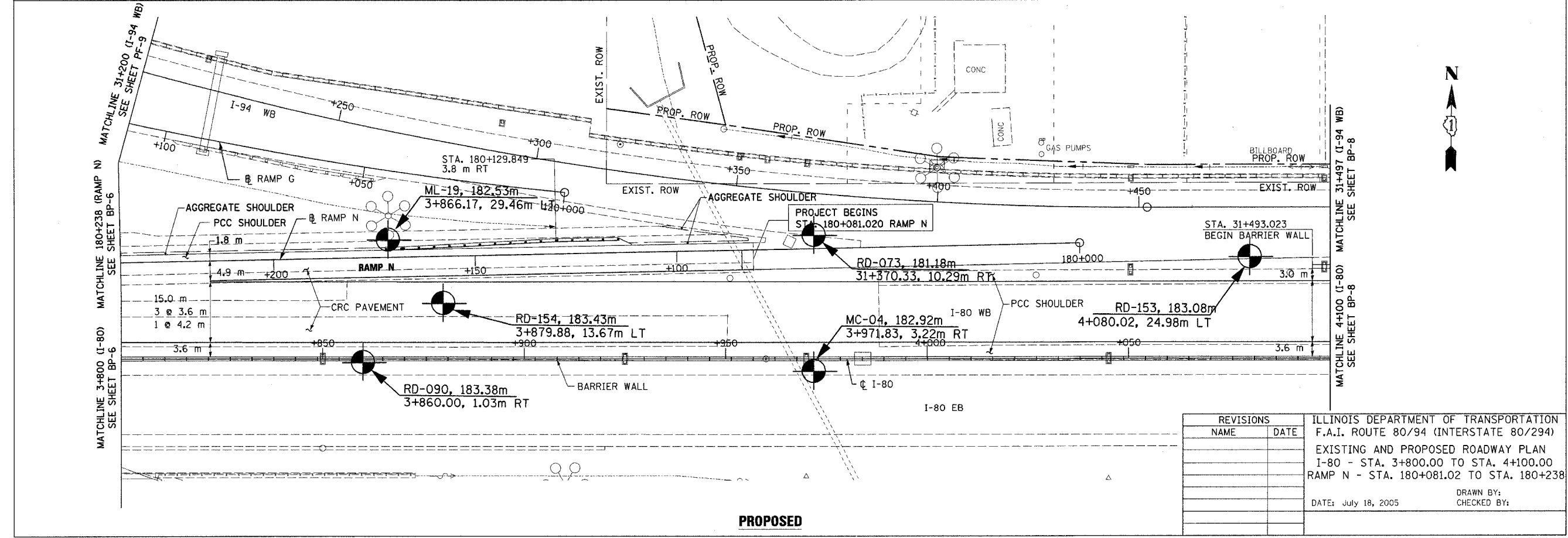
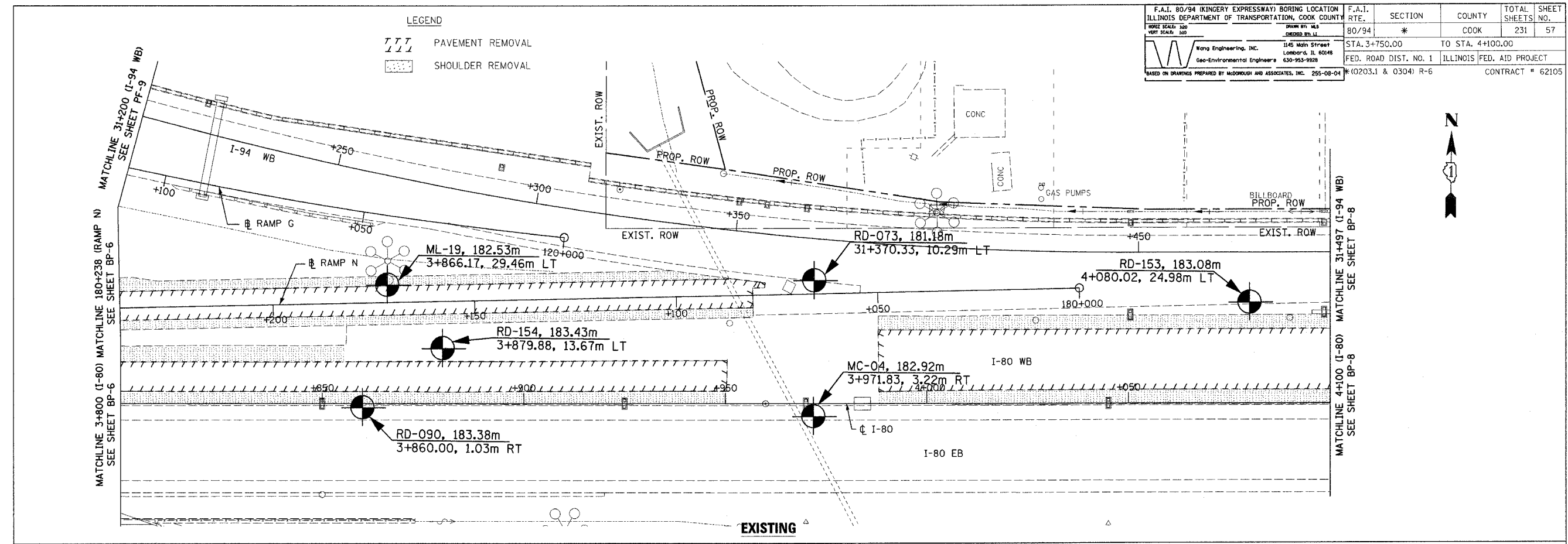

REVISIONS	
NAME	DATE

ILLINOIS DEPARTMENT OF TRANSPORTATION
F.A.I. ROUTE 80/94 (INTERSTATE 80/294)
EXISTING AND PROPOSED ROADWAY PLAN
I-80 - STA. 3+800.00 TO STA. 4+100.00
RAMP N - STA. 180+081.02 TO STA. 180+238

DATE: July 18, 2005
DRAWN BY:
CHECKED BY:

F.A.I. 80/94 (KINGERY EXPRESSWAY) BORING LOCATION	F.A.I. RTE.	SECTION	COUNTY	TOTAL SHEETS	SHEET NO.
ILLINOIS DEPARTMENT OF TRANSPORTATION, COOK COUNTY	80/94	*	COOK	231	58
DRAWN BY: M.S. CHECKED BY: L.L.		STA. 4+100.00 TO STA. 4+450.00			
Wang Engineering, Inc. 1145 Main Street Lombard, IL 60148 Geo-Environmental Engineers 630-953-9528		FED. ROAD DIST. NO. 1 ILLINOIS FED. AID PROJECT			
BASED ON DRAWINGS PREPARED BY MCDONOUGH AND ASSOCIATES, INC. 255-08-04		* (10203.1 & 0304) R-6		CONTRACT # 62105	

LEGEND
 PAVEMENT REMOVAL
 SHOULDER REMOVAL

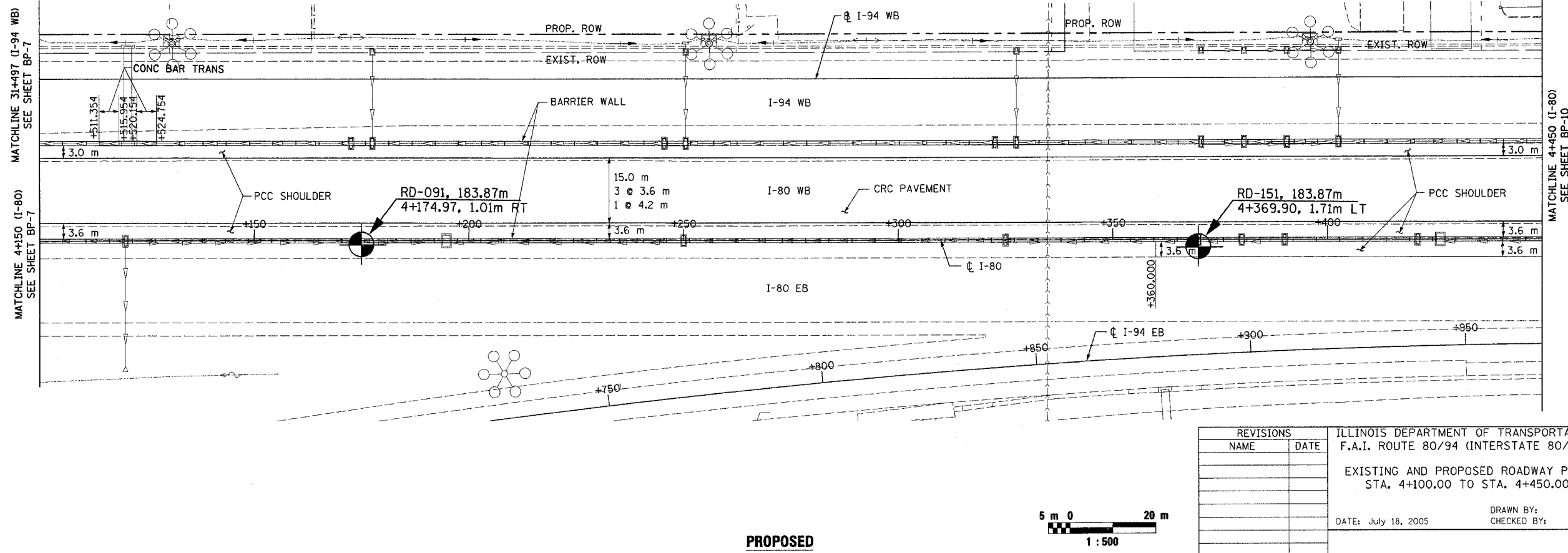
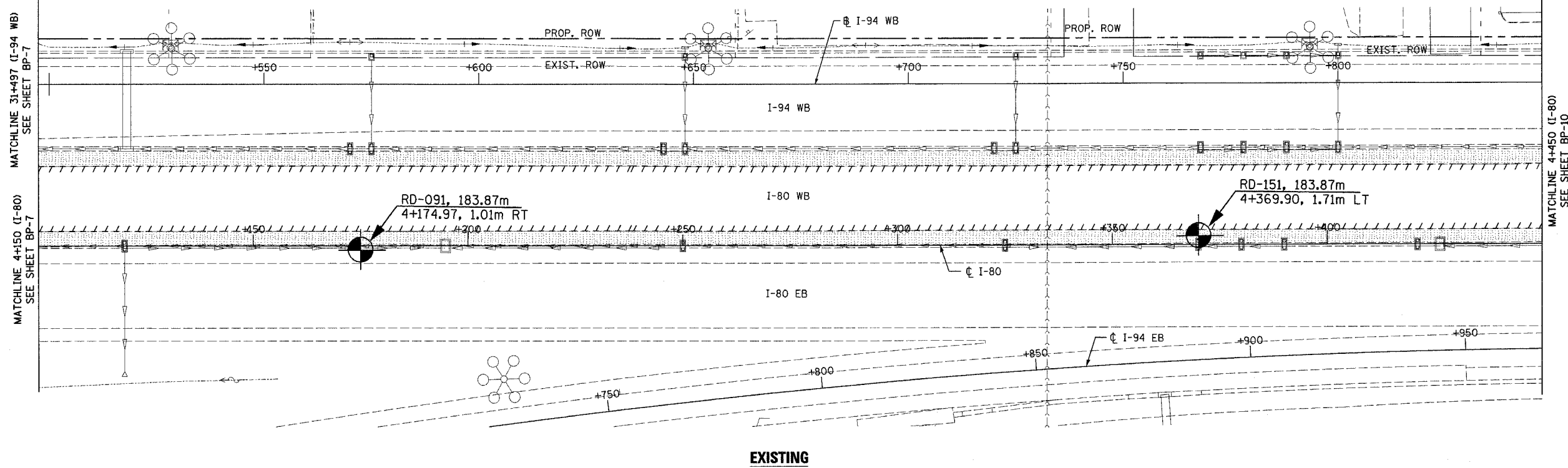

REVISIONS		ILLINOIS DEPARTMENT OF TRANSPORTATION F.A.I. ROUTE 80/94 (INTERSTATE 80/294)
NAME	DATE	
		EXISTING AND PROPOSED ROADWAY PLAN STA. 4+100.00 TO STA. 4+450.00

DATE: July 18, 2005 DRAWN BY: CHECKED BY:

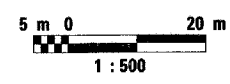

F.A.I. 80/94 (KINGERY EXPRESSWAY) BORING LOCATION ILLINOIS DEPARTMENT OF TRANSPORTATION, COOK COUNTY	F.A.I. SECTION COUNTY TOTAL SHEETS SHEET NO. 80/94 * COOK 231 59
STA. 4+100.00 TO STA. 4+800.00 FED. ROAD DIST. NO. 1 ILLINOIS FED. AID PROJECT *10203.1 & Q304: F-6 CONTRACT # 62105	

BY	DATE
FINAL SURVEYED SURVEY PLOTTED	
NOTE BOOK TEMPLATE	
AREAS CHECKED	
NO.	

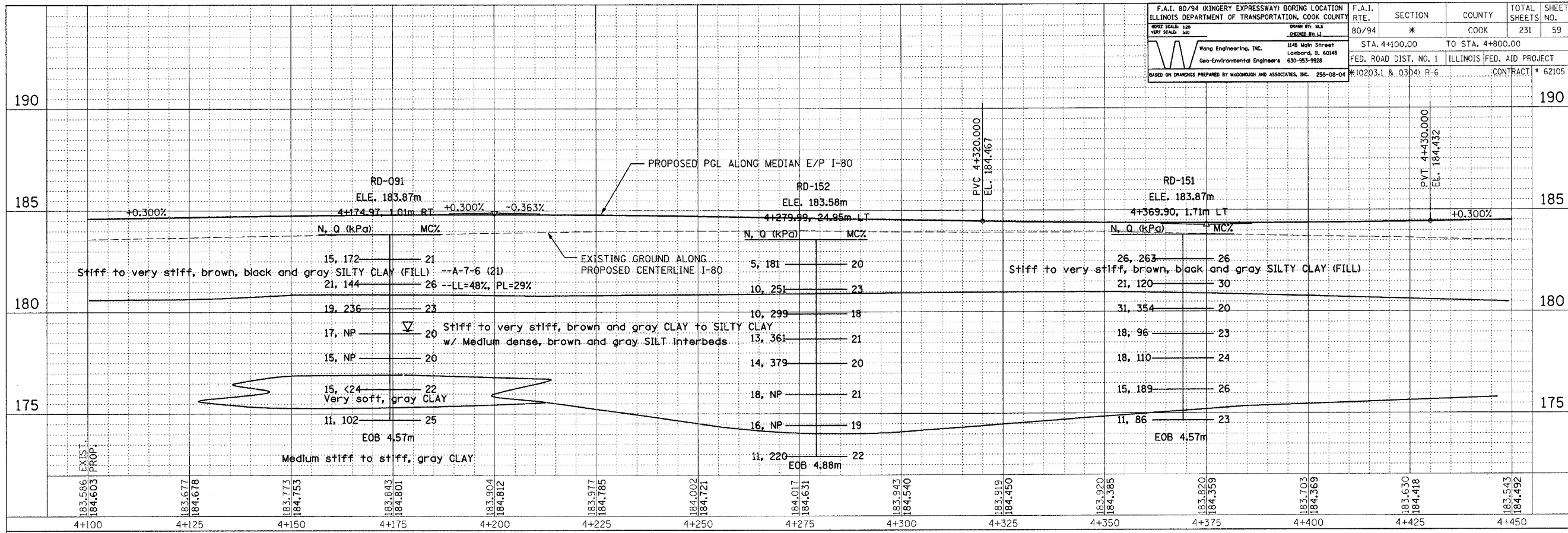

BY	DATE
ORIGINAL SURVEYED SURVEY PLOTTED	
NOTE BOOK TEMPLATE	
AREAS CHECKED	
NO.	

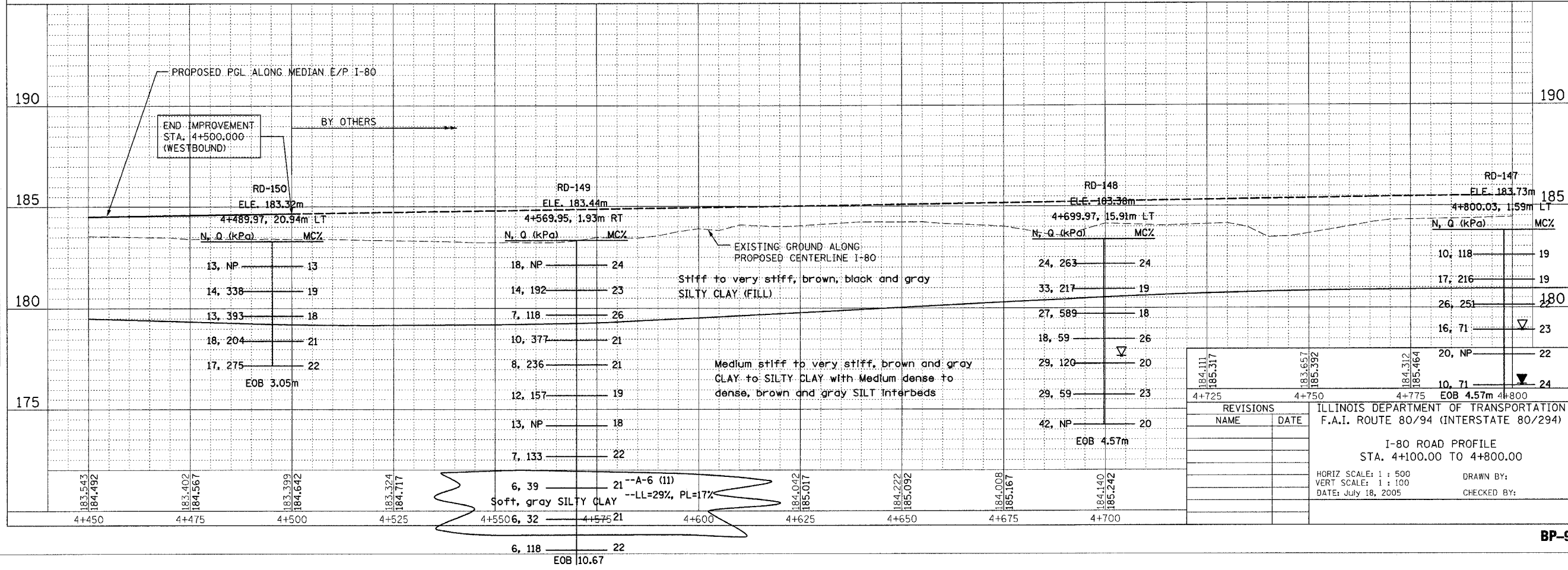

184.111 185.317	183.667 185.392	184.312 185.464	4+725	4+750	4+775	4+800
REVISIONS		ILLINOIS DEPARTMENT OF TRANSPORTATION F.A.I. ROUTE 80/94 (INTERSTATE 80/294)				
NAME	DATE	I-80 ROAD PROFILE STA. 4+100.00 TO 4+800.00				
		HORIZ SCALE: 1 : 500 VERT SCALE: 1 : 100 DATE: July 18, 2005				
		DRAWN BY: CHECKED BY:				

F.A.I. 80/94 (KINGERY EXPRESSWAY) BORING LOCATION	F.A.I. SECTION	COUNTY	TOTAL SHEETS	SHEET NO.
ILLINOIS DEPARTMENT OF TRANSPORTATION, COOK COUNTY	80/94 *	COOK	231	60
Wong Engineering, Inc. Geo-Environmental Engineers	1145 Main Street Lombard, IL 60148 630-953-9928	STA. 4+450.00 TO STA. 4+800.00		
FED. ROAD DIST. NO. 1		ILLINOIS FED. AID PROJECT		CONTRACT # 62105
BASED ON DRAWINGS PREPARED BY WOODSON AND ASSOCIATES, INC. 255-08-04				

LEGEND
 PAVEMENT REMOVAL
 SHOULDER REMOVAL

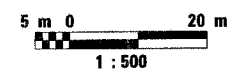
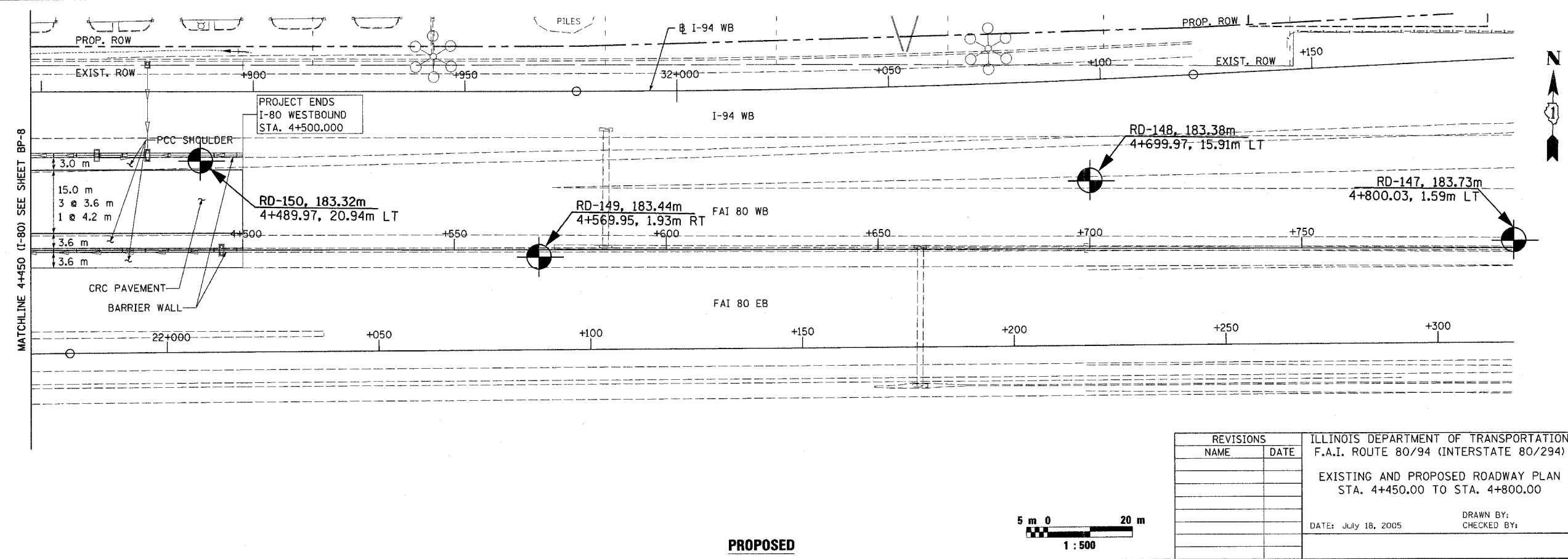
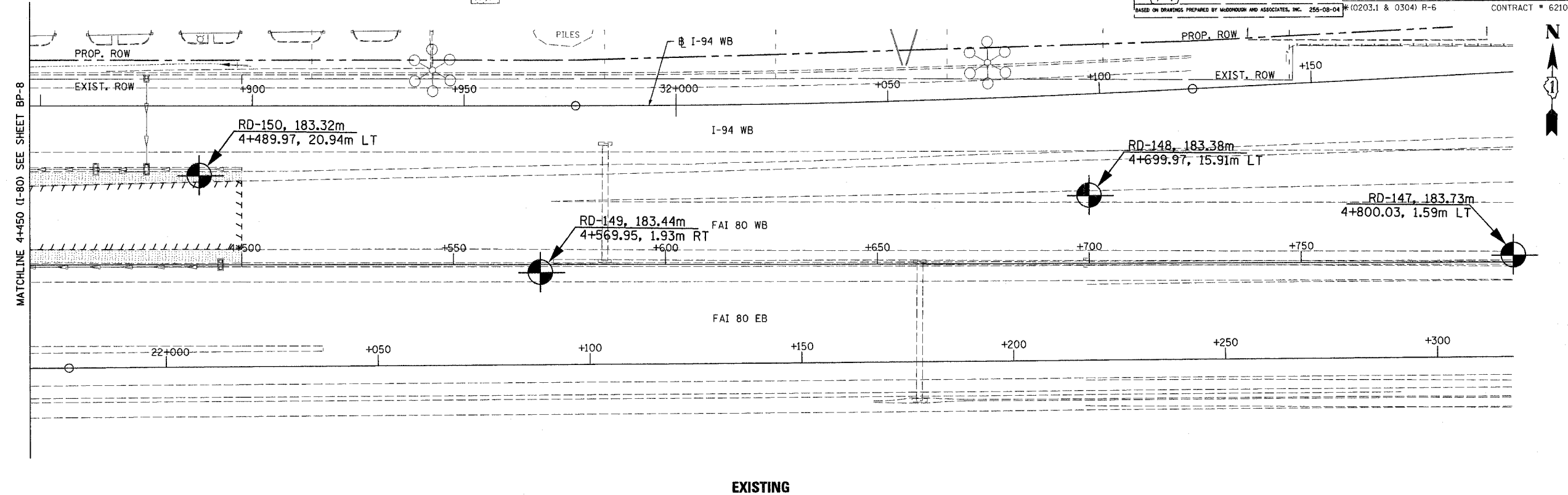

REVISIONS		ILLINOIS DEPARTMENT OF TRANSPORTATION F.A.I. ROUTE 80/94 (INTERSTATE 80/294)
NAME	DATE	
		EXISTING AND PROPOSED ROADWAY PLAN STA. 4+450.00 TO STA. 4+800.00

DATE: July 18, 2005 DRAWN BY: CHECKED BY:

F.A.I. 80/94 (KINGERY EXPRESSWAY) BORING LOCATION ILLINOIS DEPARTMENT OF TRANSPORTATION, COOK COUNTY		F.A.I. RTE.	SECTION	COUNTY	TOTAL SHEETS	SHEET NO.
DRAWN BY: MJS CHECKED BY: LL		80/94	*	COOK	231	61
Wang Engineering, Inc. Geo-Environmental Engineers 1145 Main Street Lombard, IL 60148 630-953-9328		STA. 180+000.00 TO STA. 180+200.83		ILLINOIS FED. AID PROJECT		
BASED ON DRAWINGS PREPARED BY MCDONOUGH AND ASSOCIATES, INC. 255-08-04		*10203.1 & 0304. R-6		CONTRACT * 62105		

BY	DATE

BY	DATE

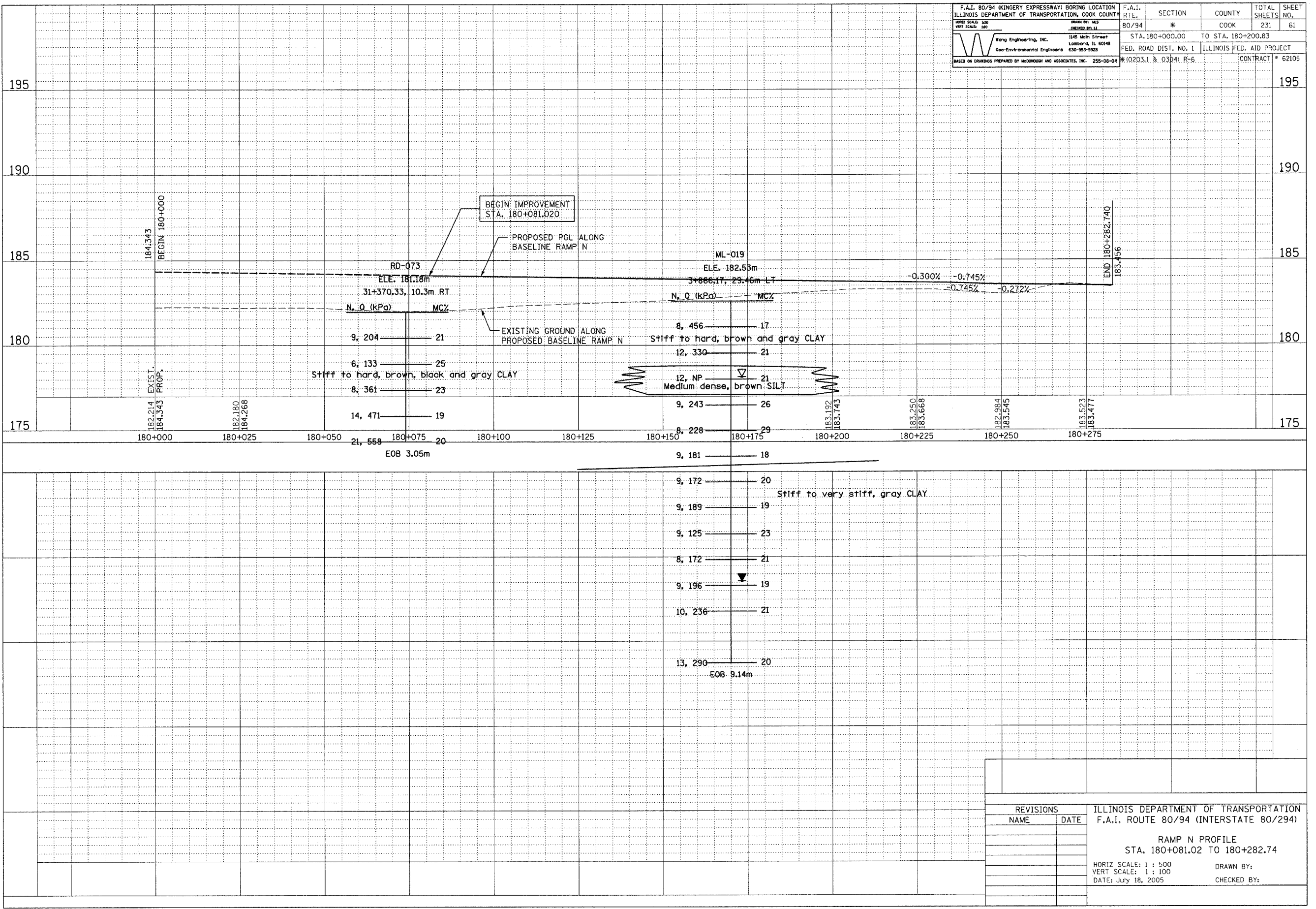

REVISIONS		ILLINOIS DEPARTMENT OF TRANSPORTATION F.A.I. ROUTE 80/94 (INTERSTATE 80/294)	
NAME	DATE		

RAMP N PROFILE
 STA. 180+081.02 TO 180+282.74
 HORIZ SCALE: 1 : 500
 VERT SCALE: 1 : 100
 DATE: July 18, 2005

DRAWN BY: _____
 CHECKED BY: _____

F.A.I. RTE.	SECTION	COUNTY	TOTAL SHEETS	SHEET NO.
80/94	*	COOK	231	62
STA. 2+967.681		TO STA. 3+100.00		
FED. ROAD DIST. NO. 1		ILLINOIS FED. AID PROJECT		
*(0203.1 & 0304) R-6		CONTRACT # 62105		

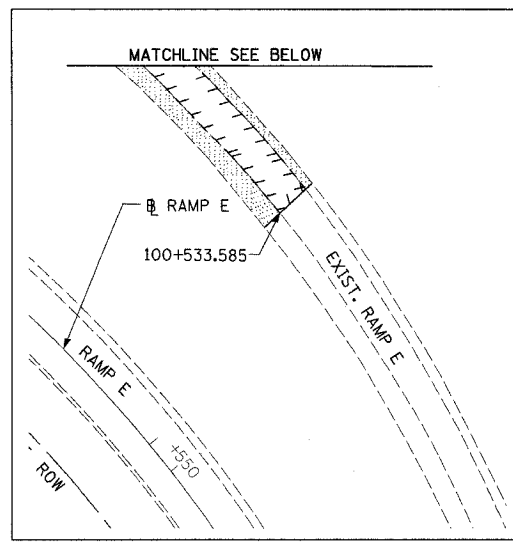

- LEGEND
- PAVEMENT REMOVAL
 - SHOULDER REMOVAL
 - ⊙(R) TEMPORARY LIGHTING (TO BE REMOVED BY OTHERS)

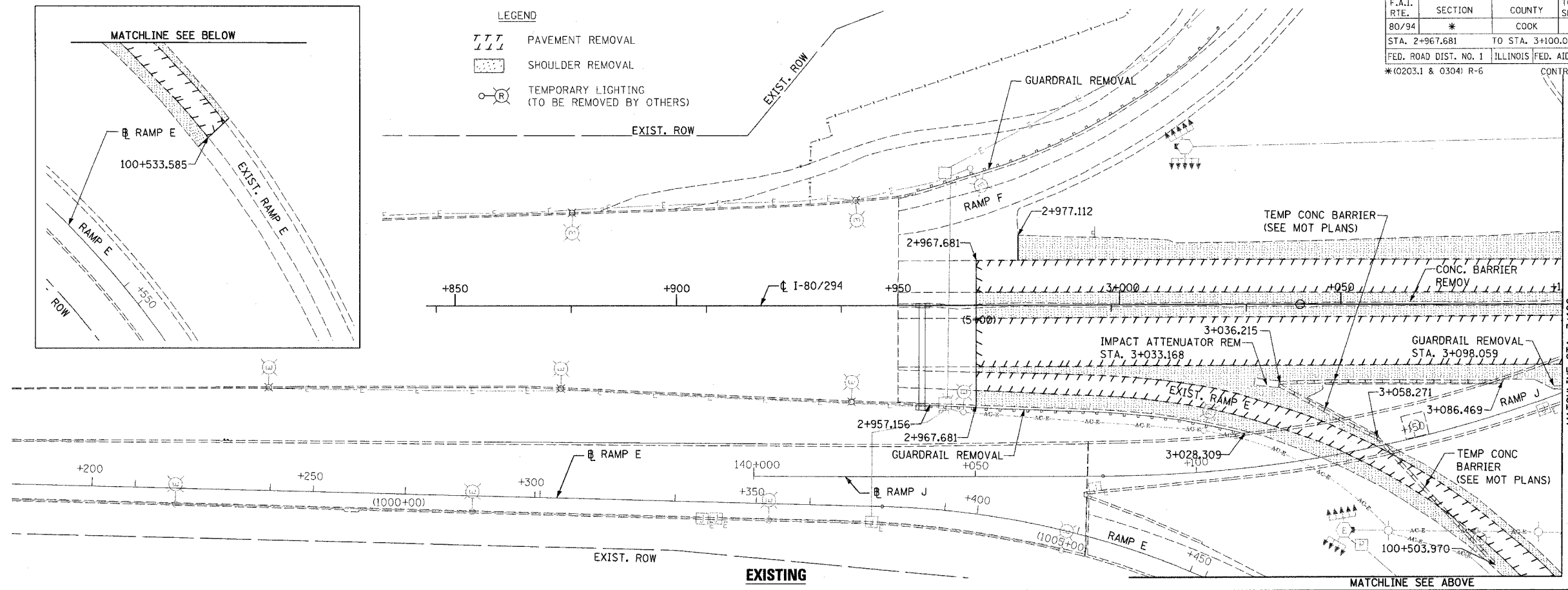

- NOTE:
1. FOR DETAILS FOR THE CONCRETE GUTTER TYPE A (MODIFIED) SEE MD-3
 2. FOR LOCATIONS OF THE CONCRETE GLARE SCREEN, SPECIAL SEE RL16-1 THRU RL16-5
 3. FOR DETAILS FOR THE CONCRETE GLARE SCREEN, SPECIAL SEE MD-6

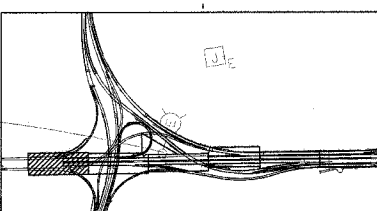
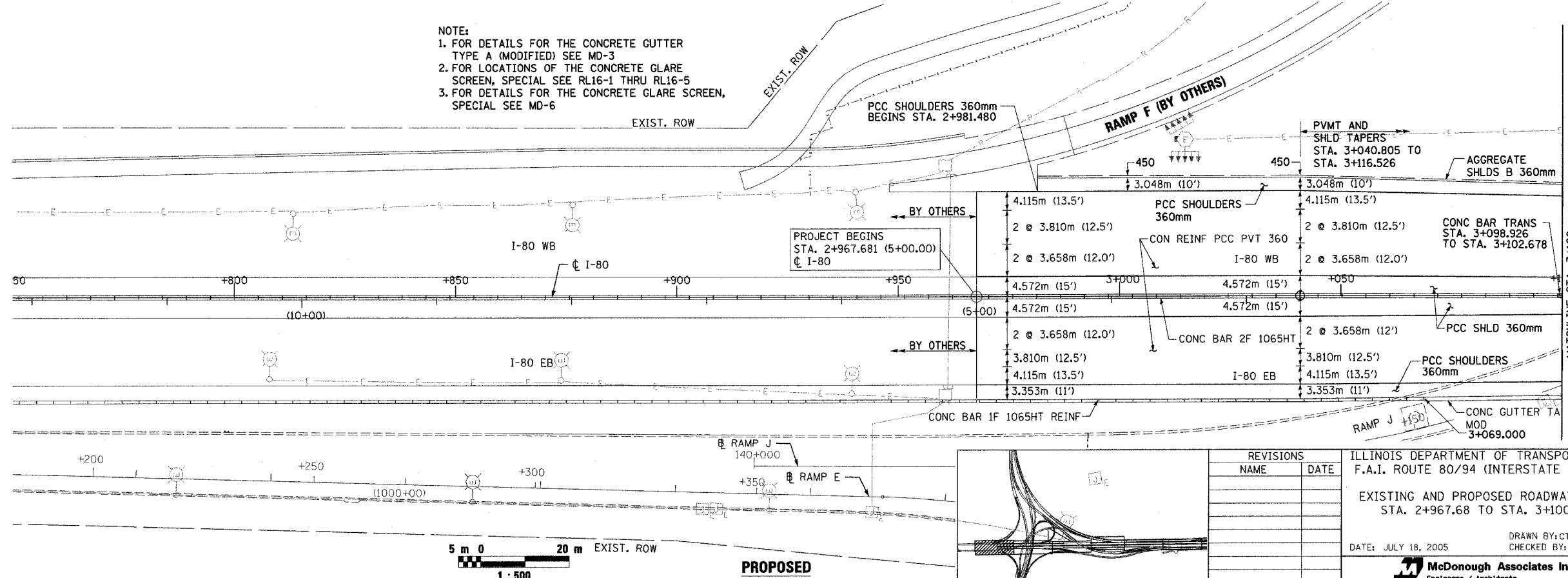

REVISIONS	
NAME	DATE

ILLINOIS DEPARTMENT OF TRANSPORTATION
 F.A.I. ROUTE 80/94 (INTERSTATE 80/294)
 EXISTING AND PROPOSED ROADWAY PLAN
 STA. 2+967.68 TO STA. 3+100.00
 DATE: JULY 18, 2005
 DRAWN BY: CTT
 CHECKED BY: RCH
McDonough Associates Inc.
 Engineers / Architects

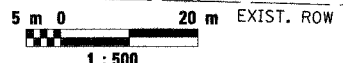

MATCHLINE STA. 3+100 SEE SHEET PF-2



MATCHLINE STA. 3+100 SEE SHEET PF-2

F.A.I. RTE.	SECTION	COUNTY	TOTAL SHEETS	SHEET NO.
80/94	*	COOK	231	63
STA. 3+100.00 TO STA. 3+450.00				
FED. ROAD DIST. NO. 1		ILLINOIS	FED. AID PROJECT	
*10203.1 & 03041 R-6		CONTRACT # 62105		

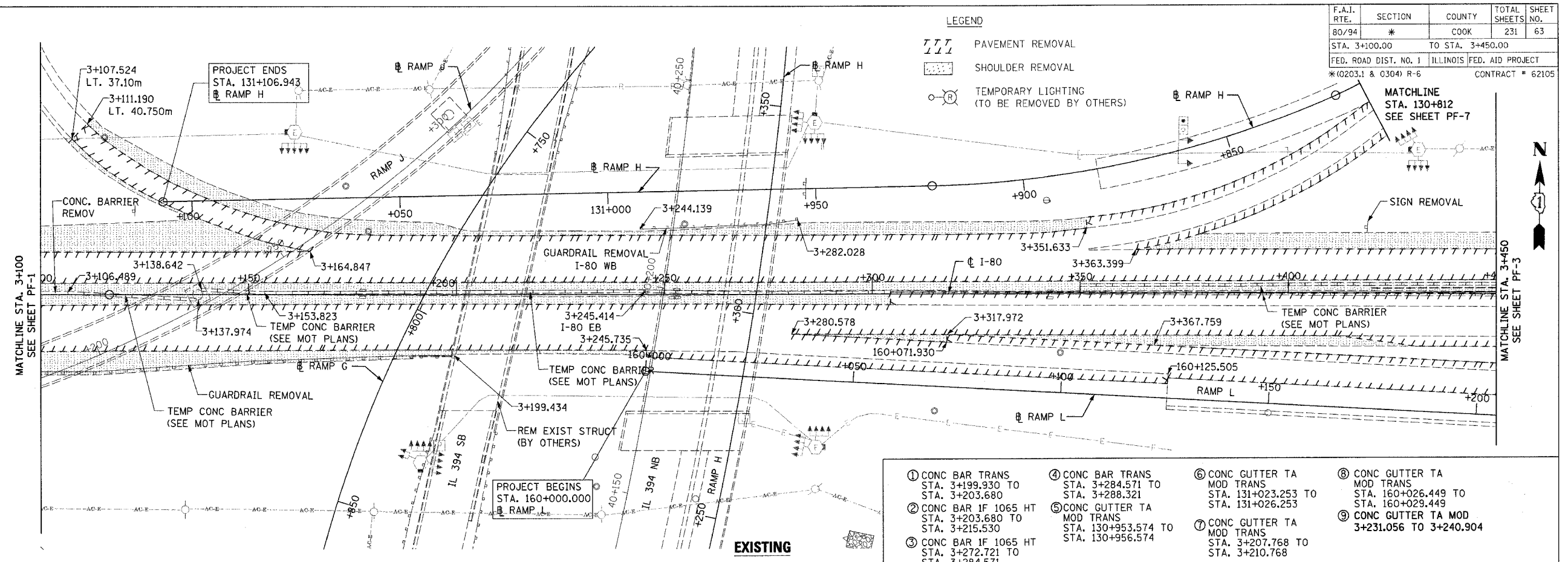

- ① CONC BAR TRANS STA. 3+199.930 TO STA. 3+203.680
- ② CONC BAR IF 1065 HT STA. 3+203.680 TO STA. 3+215.530
- ③ CONC BAR IF 1065 HT STA. 3+215.530 TO STA. 3+284.571
- ④ CONC BAR TRANS STA. 3+284.571 TO STA. 3+288.321
- ⑤ CONC GUTTER TA MOD TRANS STA. 130+953.574 TO STA. 130+956.574
- ⑥ CONC GUTTER TA MOD TRANS STA. 131+023.253 TO STA. 131+026.253
- ⑦ CONC GUTTER TA MOD TRANS STA. 3+207.768 TO STA. 3+210.768
- ⑧ CONC GUTTER TA MOD TRANS STA. 160+026.449 TO STA. 160+029.449
- ⑨ CONC GUTTER TA MOD 3+231.056 TO 3+240.904

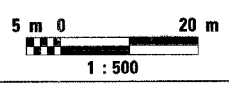
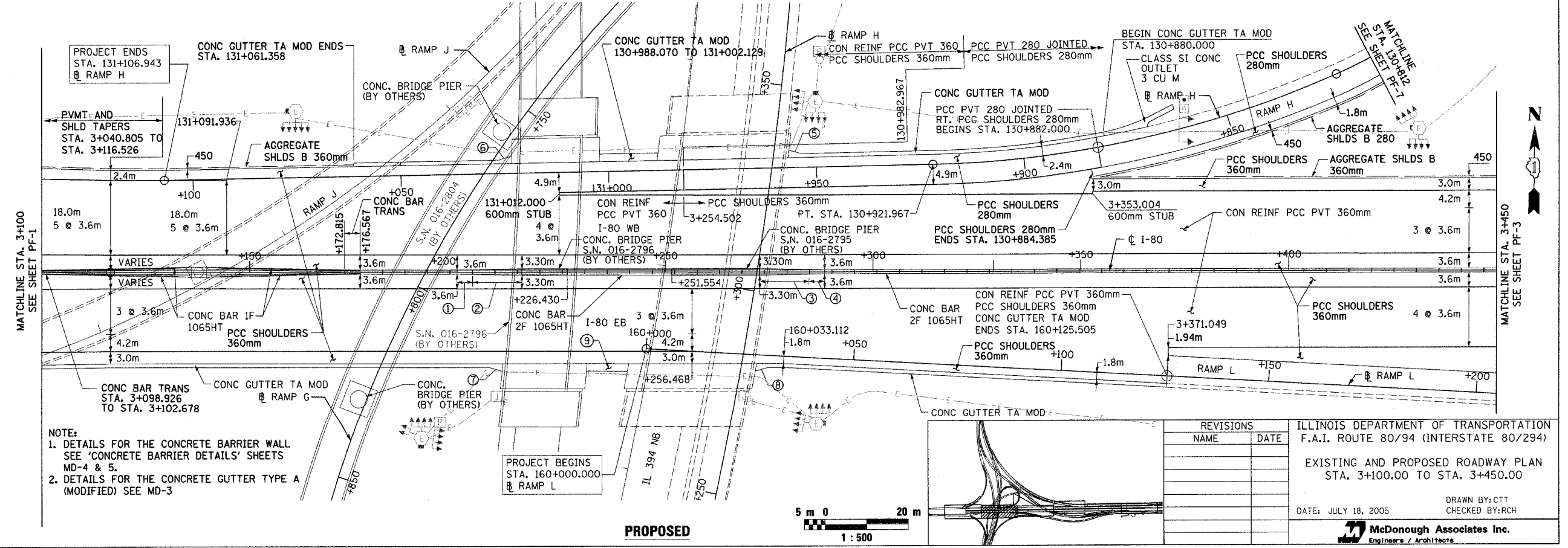

F.A.I. RTE.	SECTION	COUNTY	TOTAL SHEETS	SHEET NO.
80/94	*	COOK	231	64
STA. 3+450.00		TO STA. 3+800.00		
FED. ROAD DIST. NO. 1		ILLINOIS FED. AID PROJECT		
*10203.1 & 03041 R-6		CONTRACT # 62105		

- LEGEND**
- PAVEMENT REMOVAL
 - SHOULDER REMOVAL
 - TEMPORARY LIGHTING (TO BE REMOVED BY OTHERS)

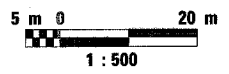
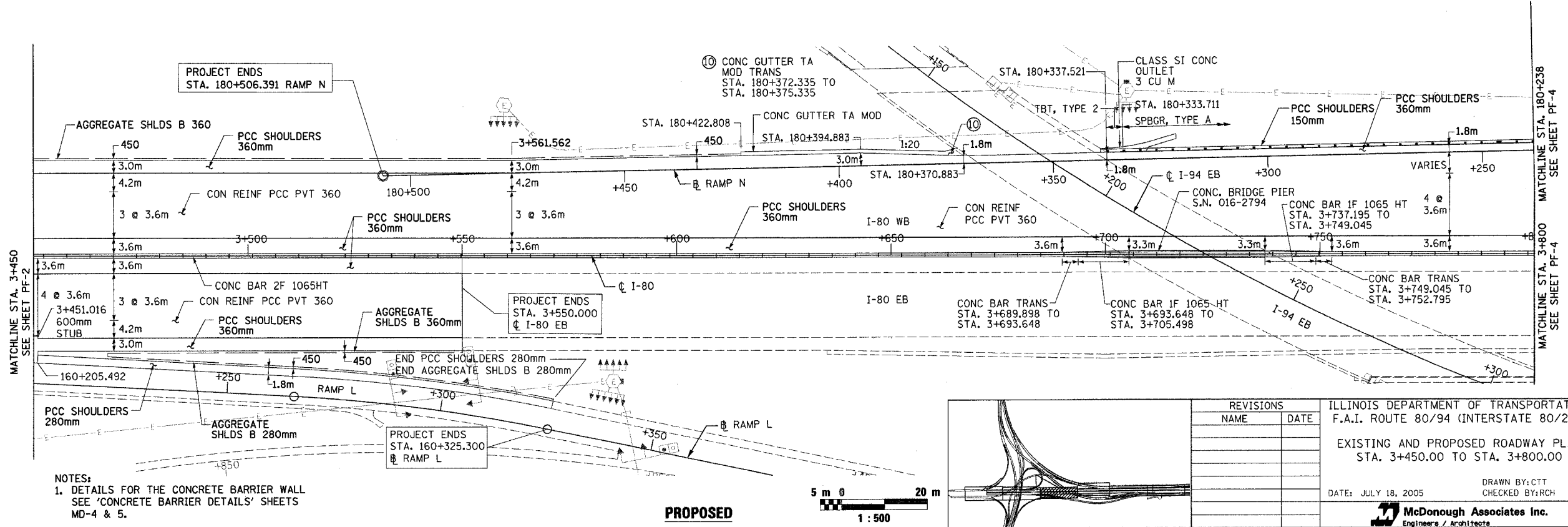
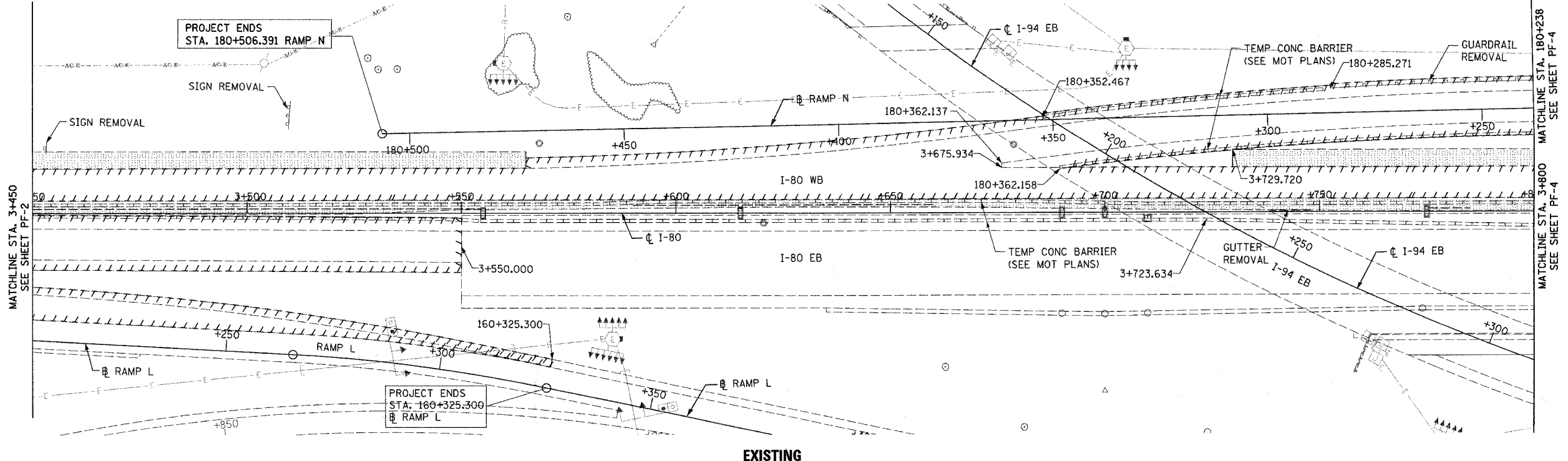

REVISIONS	
NAME	DATE

ILLINOIS DEPARTMENT OF TRANSPORTATION
F.A.I. ROUTE 80/94 (INTERSTATE 80/294)
EXISTING AND PROPOSED ROADWAY PLAN
STA. 3+450.00 TO STA. 3+800.00

DATE: JULY 18, 2005
DRAWN BY: CTT
CHECKED BY: RCH

McDonough Associates Inc.
Engineers / Architects

F.A.I. RTE.	SECTION	COUNTY	TOTAL SHEETS	SHEET NO.
80/94	*	COOK	231	65
STA. 3+800.00		TO STA. 4+100.00		
FED. ROAD DIST. NO. 1		ILLINOIS FED. AID PROJECT		
*(0203.1 & 0304) R-6		CONTRACT # 62105		

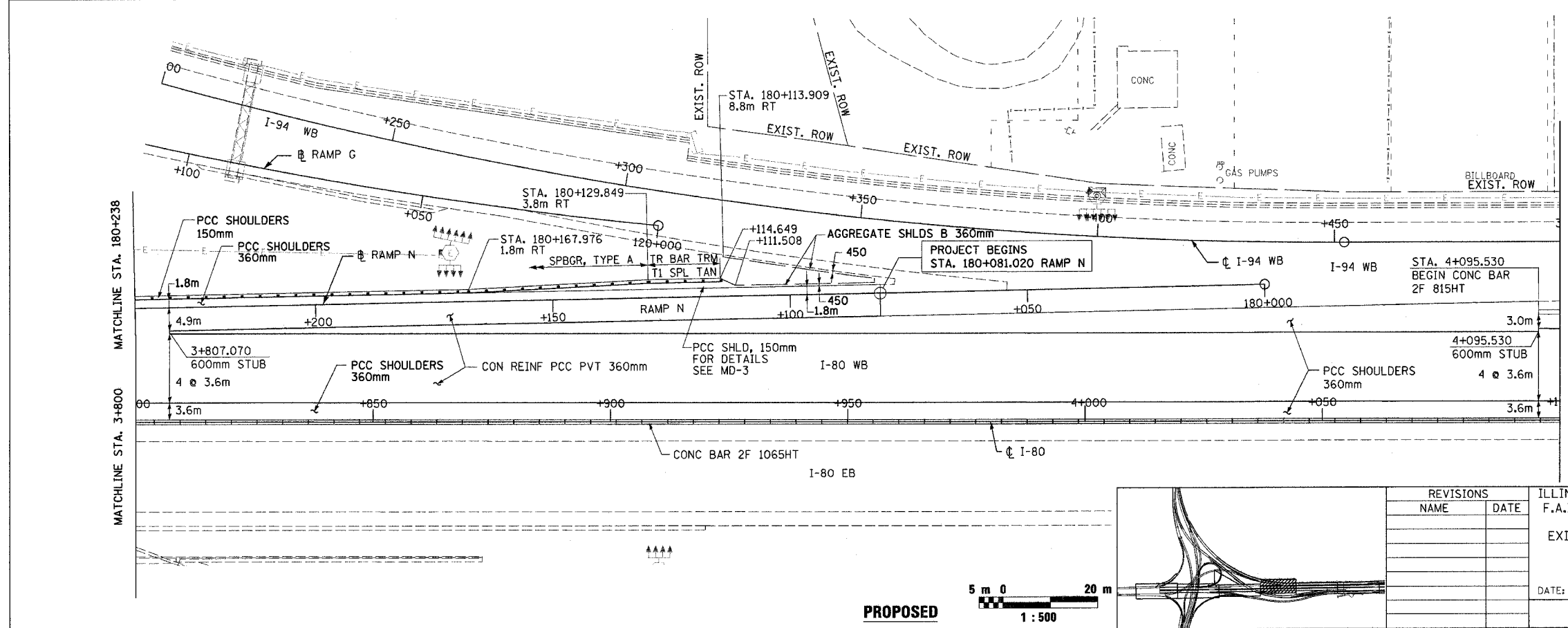
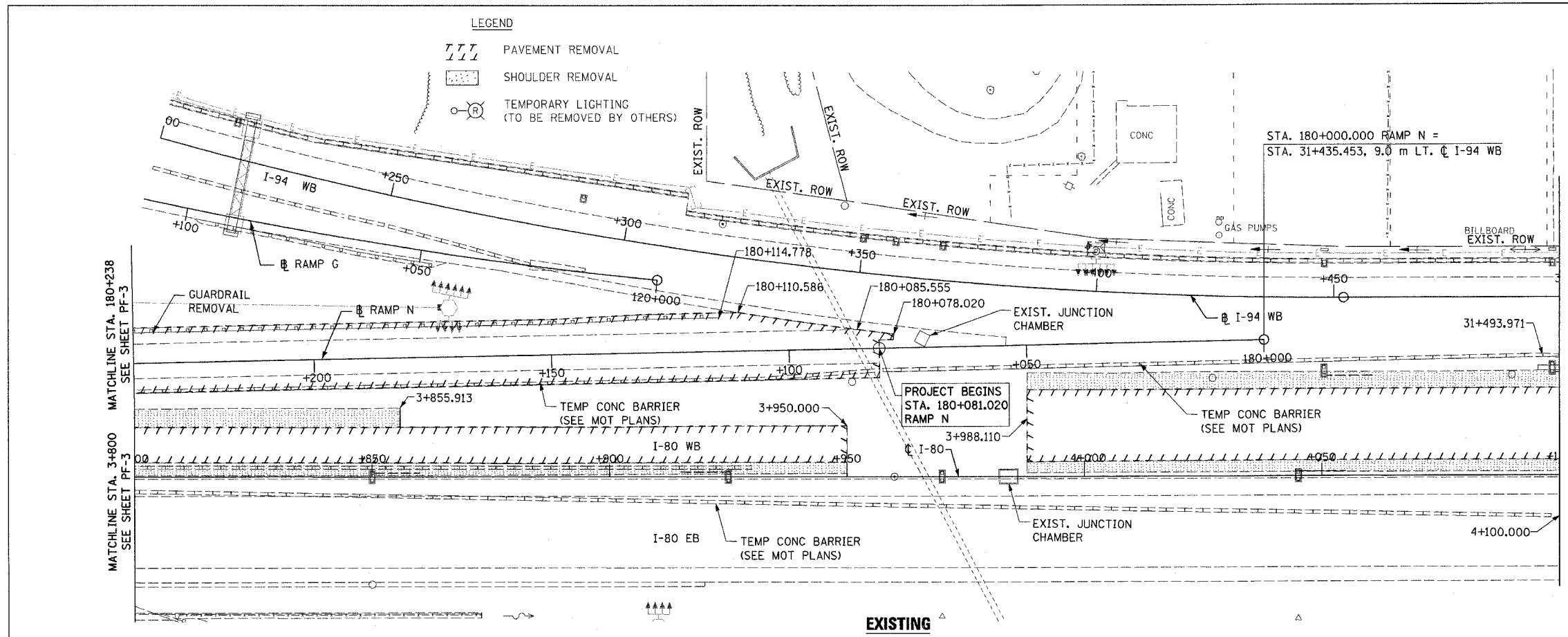

REVISIONS	
NAME	DATE

ILLINOIS DEPARTMENT OF TRANSPORTATION
 F.A.I. ROUTE 80/94 (INTERSTATE 80/294)
 EXISTING AND PROPOSED ROADWAY PLAN
 STA. 3+800.00 TO STA. 4+100.00
 DATE: JULY 18, 2005
 DRAWN BY: CTT
 CHECKED BY: RCH
McDonough Associates Inc.
 Engineers / Architects

F.A.I. RTE.	SECTION	COUNTY	TOTAL SHEETS	SHEET NO.
80/94	*	COOK	231	66
STA. 4+100.00		TO STA. 4+450.00		
FED. ROAD DIST. NO. 1		ILLINOIS FED. AID PROJECT		
*(0203.1 & 0304) R-6		CONTRACT # 62105		

- LEGEND**
- PAVEMENT REMOVAL
 - SHOULDER REMOVAL
 - TEMPORARY LIGHTING (TO BE REMOVED BY OTHERS)

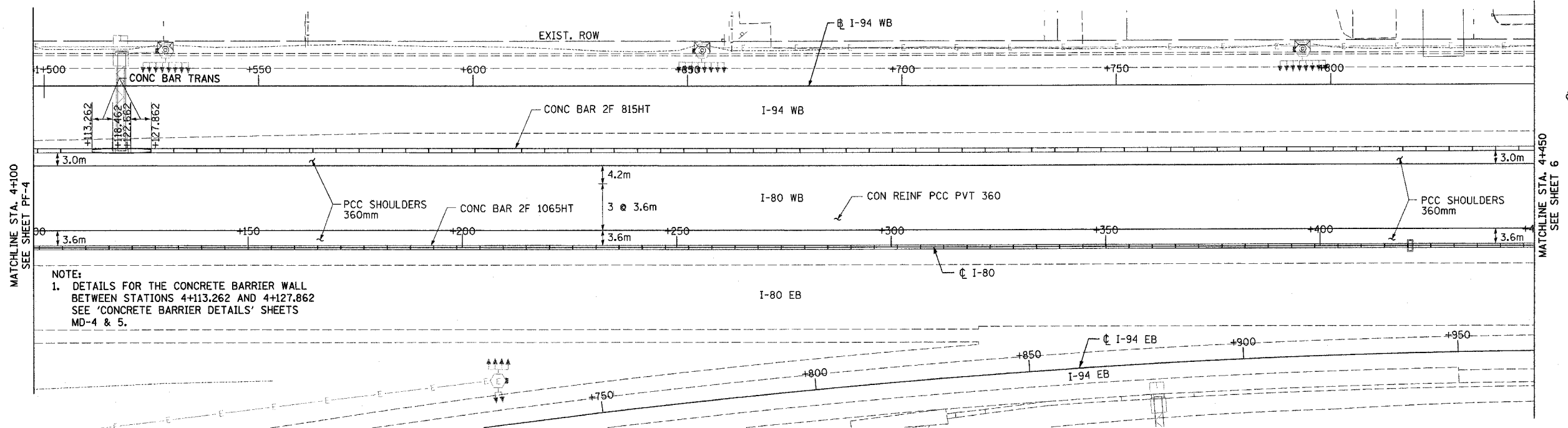
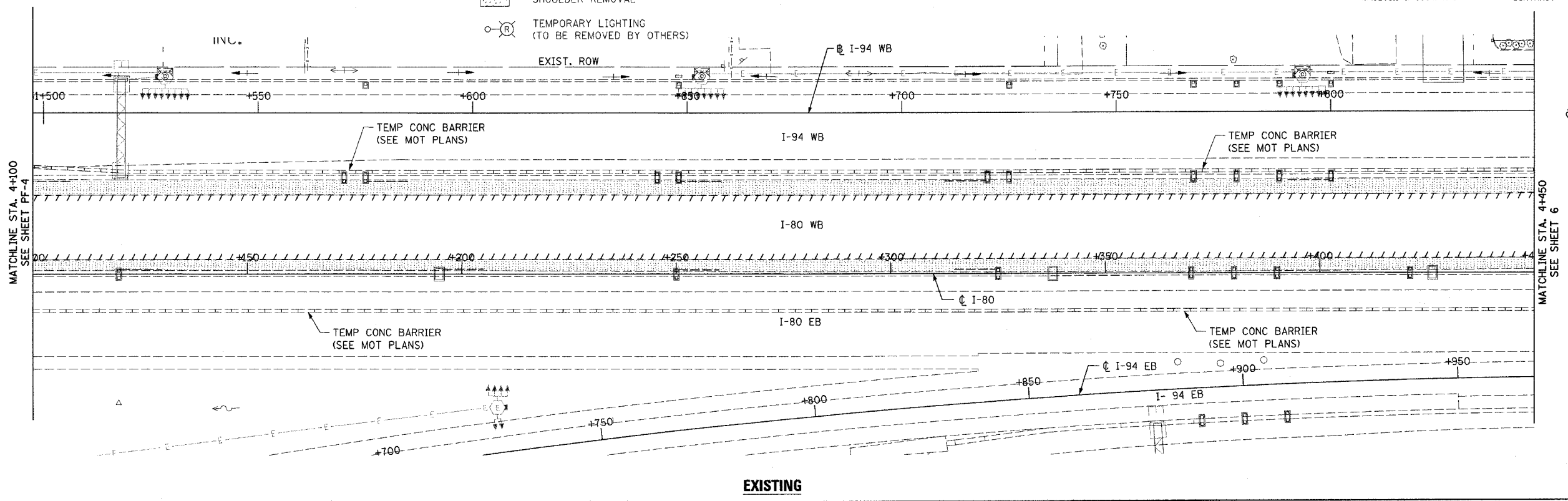



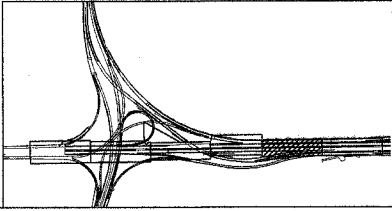
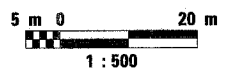

NOTE:
 1. DETAILS FOR THE CONCRETE BARRIER WALL BETWEEN STATIONS 4+113.262 AND 4+127.862 SEE 'CONCRETE BARRIER DETAILS' SHEETS MD-4 & 5.



REVISIONS	
NAME	DATE

ILLINOIS DEPARTMENT OF TRANSPORTATION
 F.A.I. ROUTE 80/94 (INTERSTATE 80/294)
 EXISTING AND PROPOSED ROADWAY PLAN
 STA. 4+100.00 TO STA. 4+450.00
 DATE: JULY 18, 2005
 DRAWN BY: CTT
 CHECKED BY: RCH
 McDonough Associates Inc.
 Engineers / Architects

LEGEND

-  PAVEMENT REMOVAL
-  SHOULDER REMOVAL
-  PILES
-  TEMPORARY LIGHTING (TO BE REMOVED BY OTHERS)

F.A.I. RTE.	SECTION	COUNTY	TOTAL SHEETS	SHEET NO.
80/94	*	COOK	231	67
STA. 4+450.00		TO STA. 4+500.00		
FED. ROAD DIST. NO. 1		ILLINOIS FED. AID PROJECT		
* (0203.1 & 0304) R-6		CONTRACT # 62105		

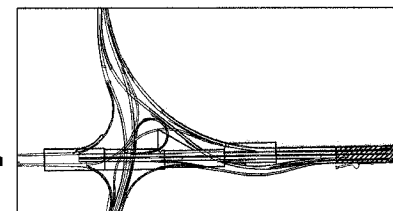
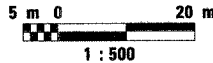
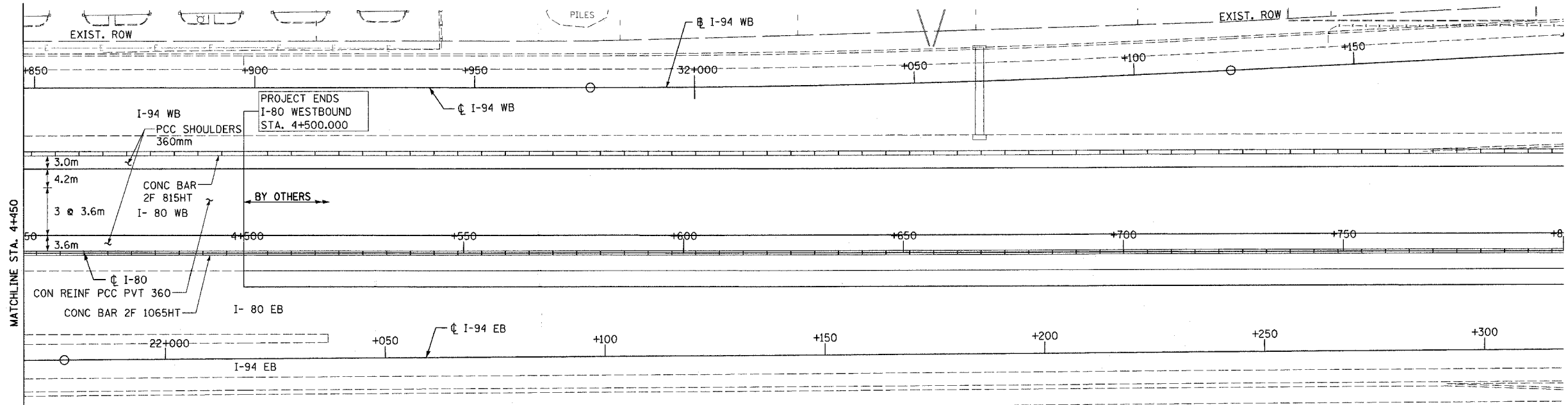
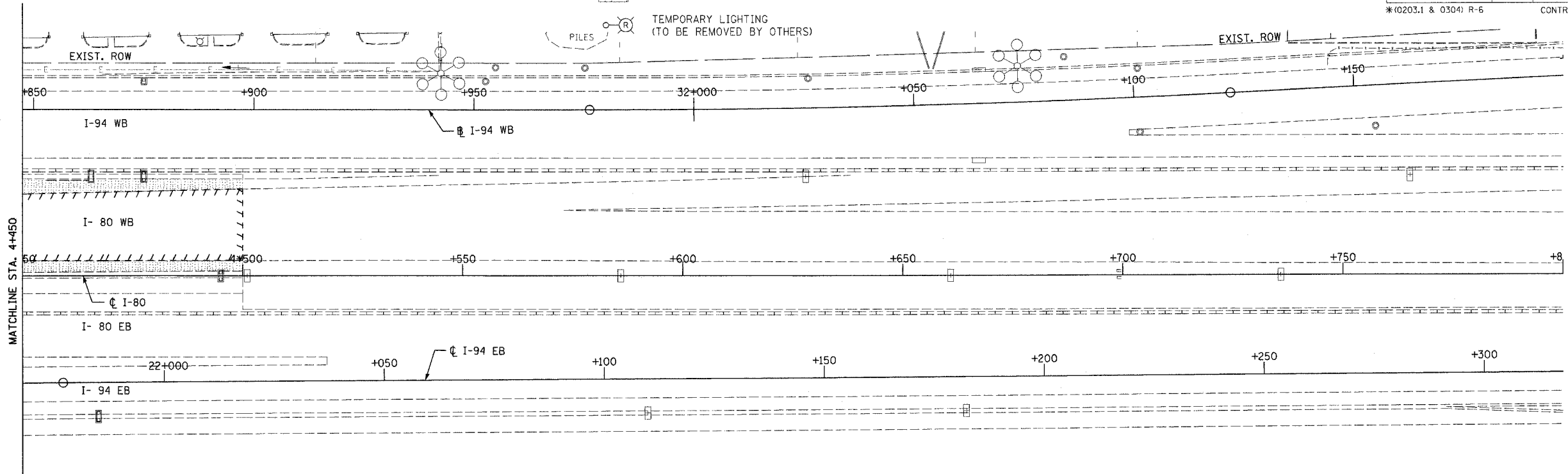

REVISIONS	
NAME	DATE

ILLINOIS DEPARTMENT OF TRANSPORTATION
 F.A.I. ROUTE 80/94 (INTERSTATE 80/294)

EXISTING AND PROPOSED ROADWAY PLAN
 STA. 4+450.00 TO STA. 4+500.00



DATE: JULY 18, 2005

DRAWN BY: CTT
 CHECKED BY: RCH

 McDonough Associates Inc.
 Engineers / Architects

F.A.I. RTE.	SECTION	COUNTY	TOTAL SHEETS	SHEET NO.
80/94	*	COOK	231	68
STA. 130+812.00		TO STA. 130+750.00		
FED. ROAD DIST. NO. 1		ILLINOIS FED. AID PROJECT		
*(0203.1 & 0304) R-6		CONTRACT # 62105		

LEGEND

-  PAVEMENT REMOVAL
-  SHOULDER REMOVAL
-  TEMPORARY LIGHTING (TO BE REMOVED BY OTHERS)

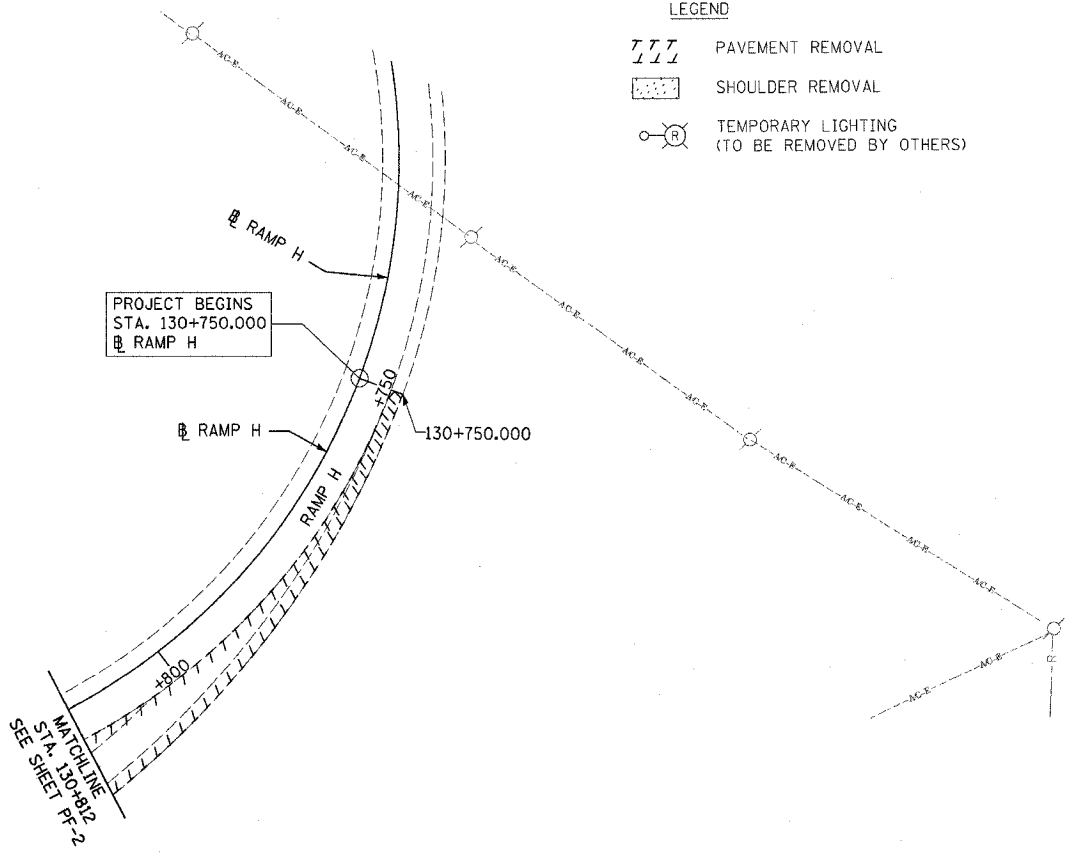

EXISTING

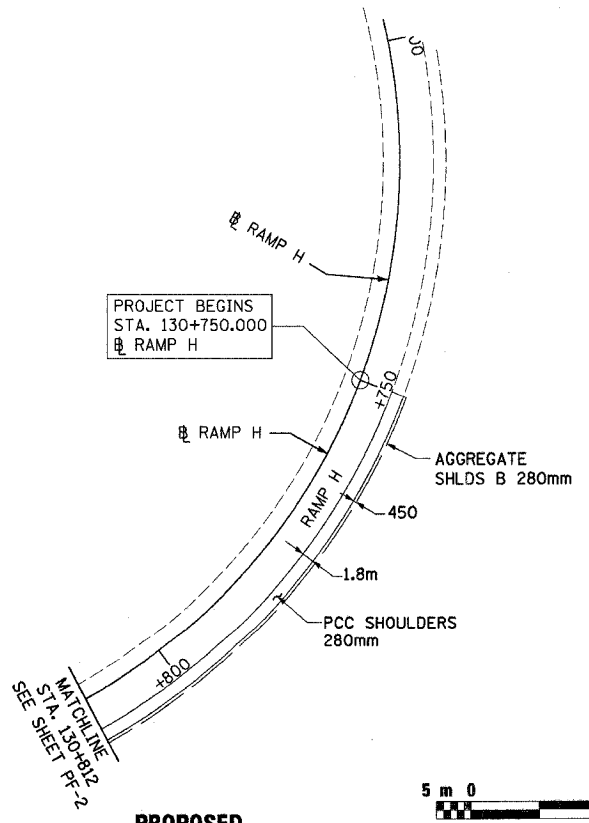

PROPOSED

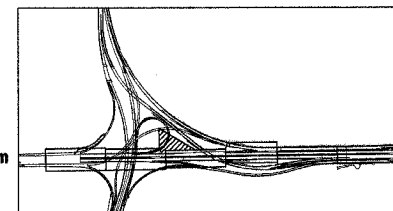
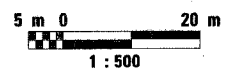

REVISIONS	
NAME	DATE

ILLINOIS DEPARTMENT OF TRANSPORTATION
 F.A.I. ROUTE 80/94 (INTERSTATE 80/294)
 EXISTING AND PROPOSED ROADWAY PLAN
 RAMP H
 DATE: JULY 18, 2005
 DRAWN BY: CTT
 CHECKED BY: RCH
 McDonough Associates Inc.
 Engineers / Architects

F.A.I. RTE.	SECTION	COUNTY	TOTAL SHEETS	SHEET NO.
80/94	*	COOK	231	69
STA. 2+967.681		TO STA. 3+400.00		
FED. ROAD DIST. NO. 1		ILLINOIS FED. AID PROJECT		
*(0203.1 & 0304) R-6		CONTRACT # 62105		

FINAL SURVEYED SURVEY PLOTTED	BY	DATE
NOTE BOOK TEMPLATE		
AREAS CHECKED		
NO.		

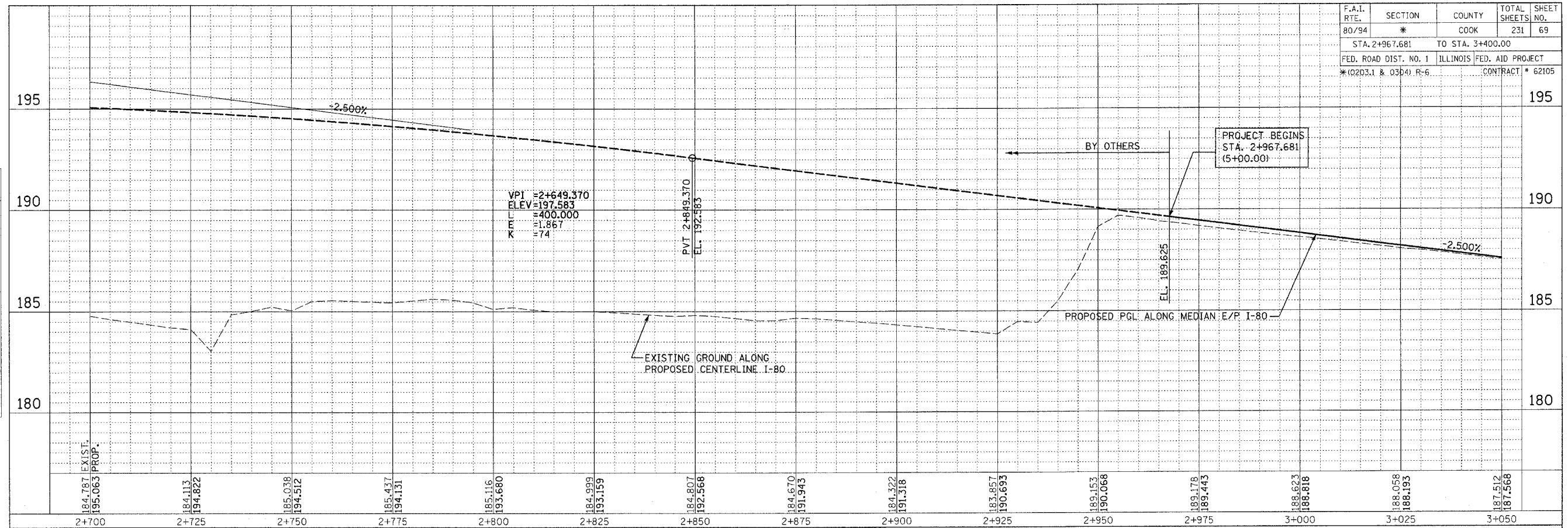

ORIGINAL SURVEYED SURVEY PLOTTED	BY	DATE
NOTE BOOK TEMPLATE		
AREAS CHECKED		
NO.		

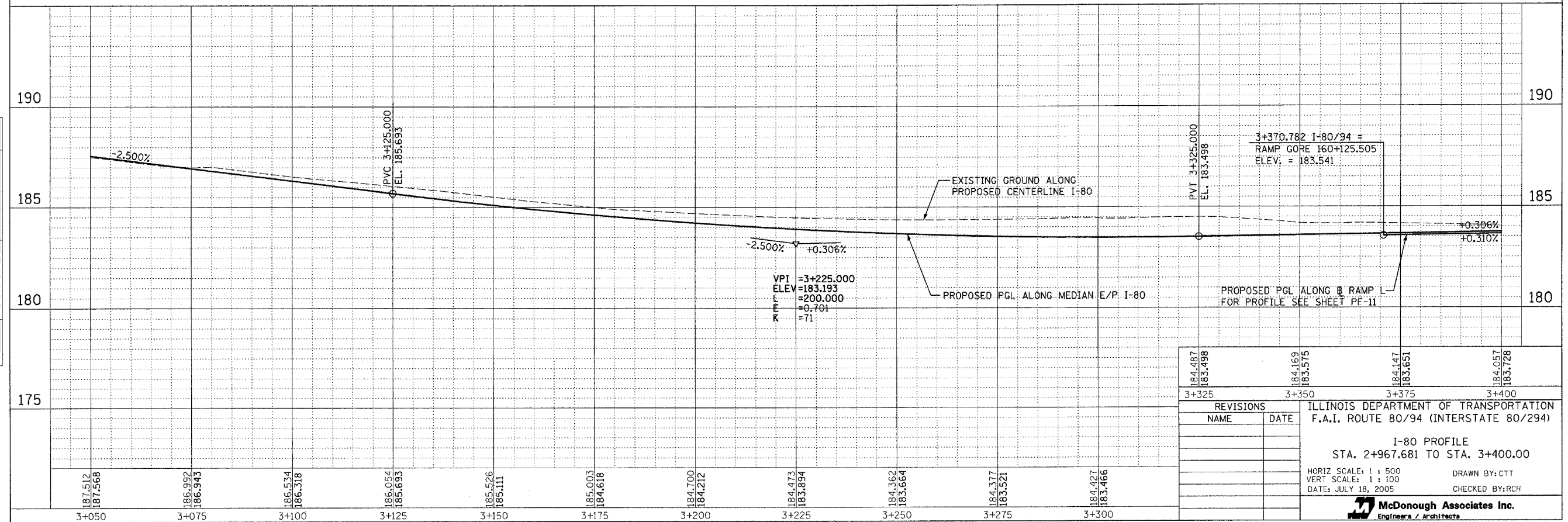

184.487	184.169	184.147	184.057
183.498	183.575	183.651	183.728
3+325	3+350	3+375	3+400
REVISIONS			
NAME	DATE		
ILLINOIS DEPARTMENT OF TRANSPORTATION			
F.A.I. ROUTE 80/94 (INTERSTATE 80/294)			
I-80 PROFILE			
STA. 2+967.681 TO STA. 3+400.00			
HORIZ SCALE: 1 : 500		DRAWN BY: CTT	
VERT SCALE: 1 : 100		CHECKED BY: RCH	
DATE: JULY 18, 2005			
McDonough Associates Inc. Engineers / Architects			

F.A.I. RTE.	SECTION	COUNTY	TOTAL SHEETS	SHEET NO.
80/94	*	COOK	231	70
STA. 3+400.00		TO STA. 4+100.00		
FED. ROAD DIST. NO. 1		ILLINOIS	FED. AID PROJECT	
*10203.1 & 03041 P-6		CONTRACT # 62105		

FINAL SURVEY	BY	DATE
SURVEYED		
PLOTTED		
NOTE BOOK		
NO.		
AREAS CHECKED		

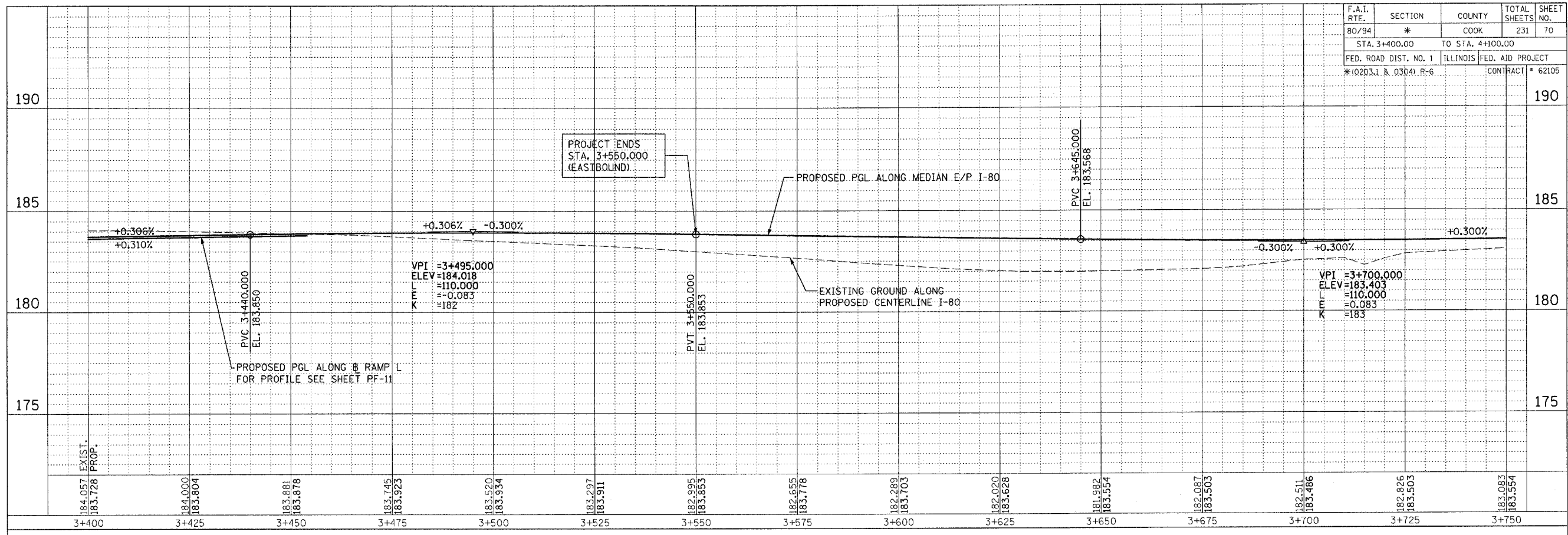

ORIGINAL SURVEY	BY	DATE
SURVEYED		
PLOTTED		
NOTE BOOK		
NO.		
AREAS CHECKED		

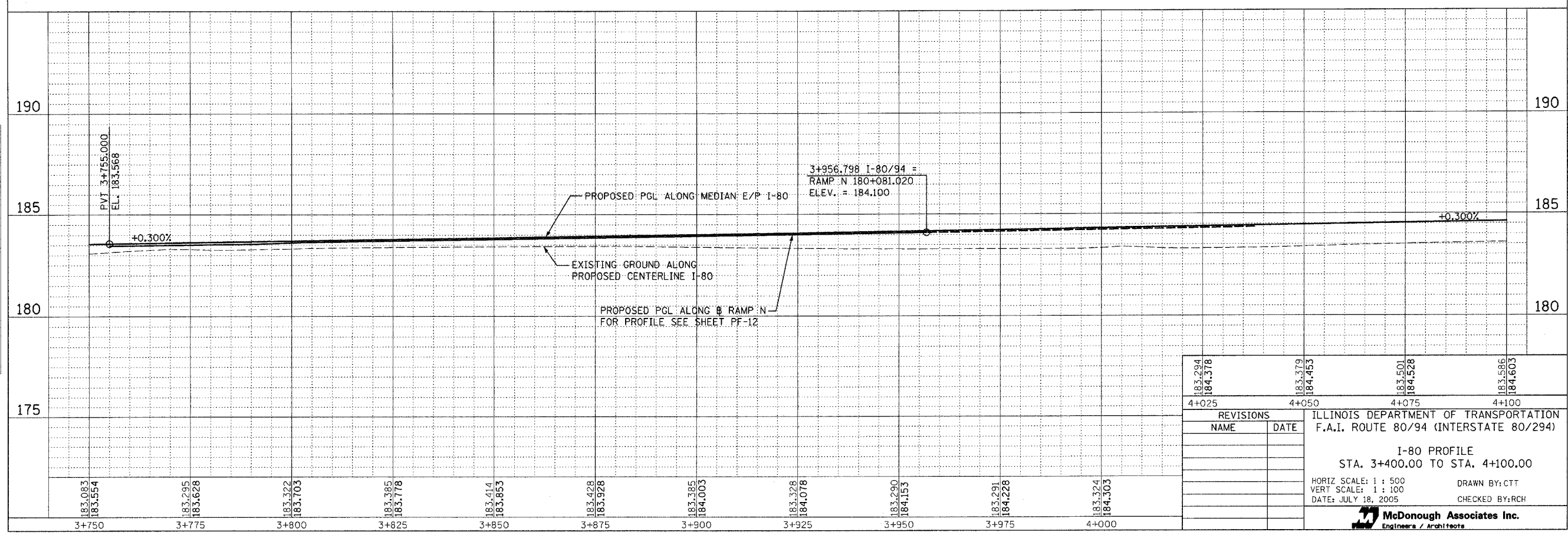

183.294	183.379	183.501	183.586
184.378	184.453	184.528	184.603
4+025	4+050	4+075	4+100
REVISIONS			
NAME	DATE		
ILLINOIS DEPARTMENT OF TRANSPORTATION F.A.I. ROUTE 80/94 (INTERSTATE 80/294)			
I-80 PROFILE STA. 3+400.00 TO STA. 4+100.00			
HORIZ SCALE: 1 : 500		DRAWN BY: CTT	
VERT SCALE: 1 : 100		CHECKED BY: RCH	
DATE: JULY 18, 2005			
McDonough Associates Inc. Engineers / Architects			

F.A.I. RTE. 80/94	SECTION *	COUNTY COOK	TOTAL SHEETS 231	SHEET NO. 71
STA. 4+100.00		TO STA. 4+500.00		
FED. ROAD DIST. NO. 1		ILLINOIS FED. AID PROJECT		
*10203.1 & 0304 R-6		CONTRACT # 62105		

FINAL SURVEY	BY	DATE
SURVEYED		
PLOTTED		
NOTE BOOK		
TEMPLATE		
AREAS CHECKED		
NO.		

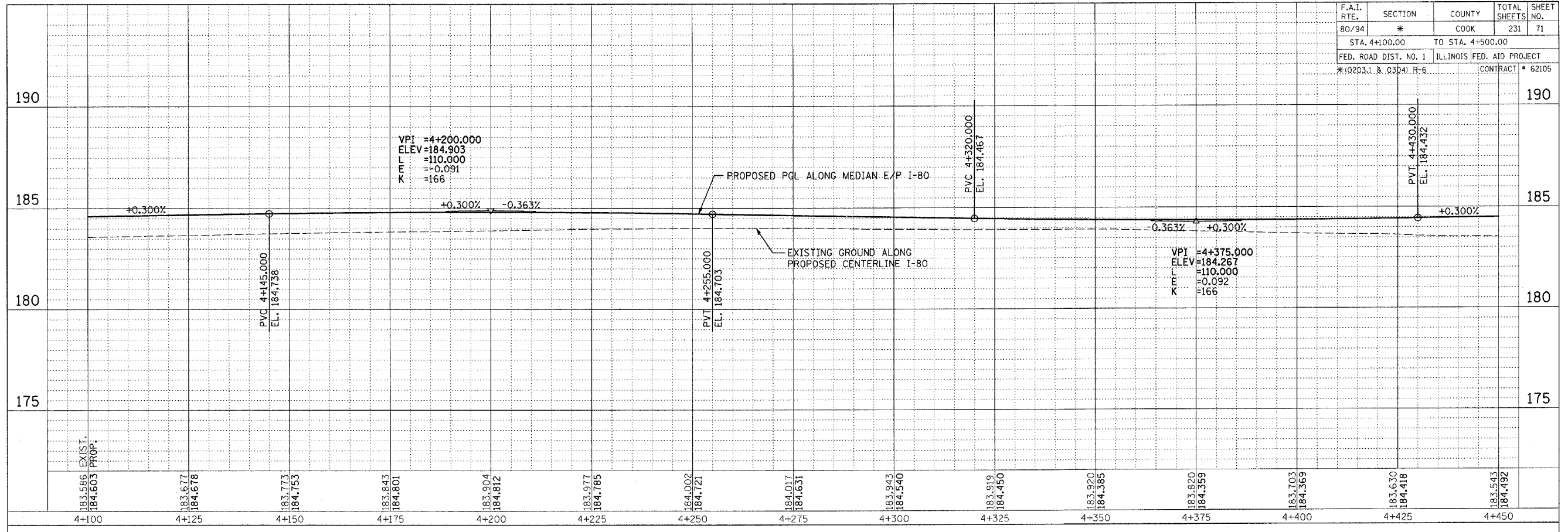

ORIGINAL SURVEY	BY	DATE
SURVEYED		
PLOTTED		
NOTE BOOK		
TEMPLATE		
AREAS CHECKED		
NO.		

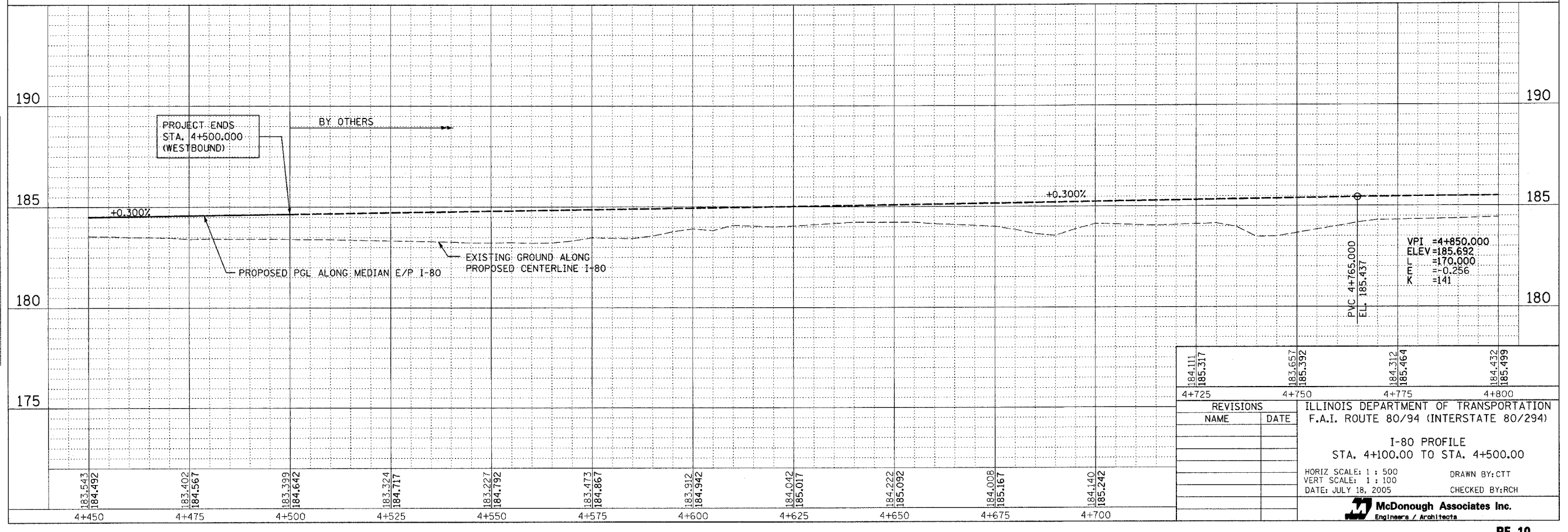

184.111	183.657	184.312	184.432
185.317	185.392	185.464	185.499
4+725	4+750	4+775	4+800
REVISIONS		ILLINOIS DEPARTMENT OF TRANSPORTATION	
NAME	DATE	F.A.I. ROUTE 80/94 (INTERSTATE 80/294)	
I-80 PROFILE			
STA. 4+100.00 TO STA. 4+500.00			
HORIZ SCALE: 1 : 500		DRAWN BY: CTT	
VERT SCALE: 1 : 100		CHECKED BY: RCH	
DATE: JULY 18, 2005			
 McDonough Associates Inc. Engineers / Architects			

F.A.I. RTE. 80/94	SECTION *	COUNTY COOK	TOTAL SHEETS 231	SHEET NO. 72
STA. 160+125.43		TO STA. 160+440.88		
FED. ROAD DIST. NO. 1		ILLINOIS FED. AID PROJECT		
* (0203.1 & 0304) R-6		CONTRACT # 62105		

FOR INFORMATION ONLY

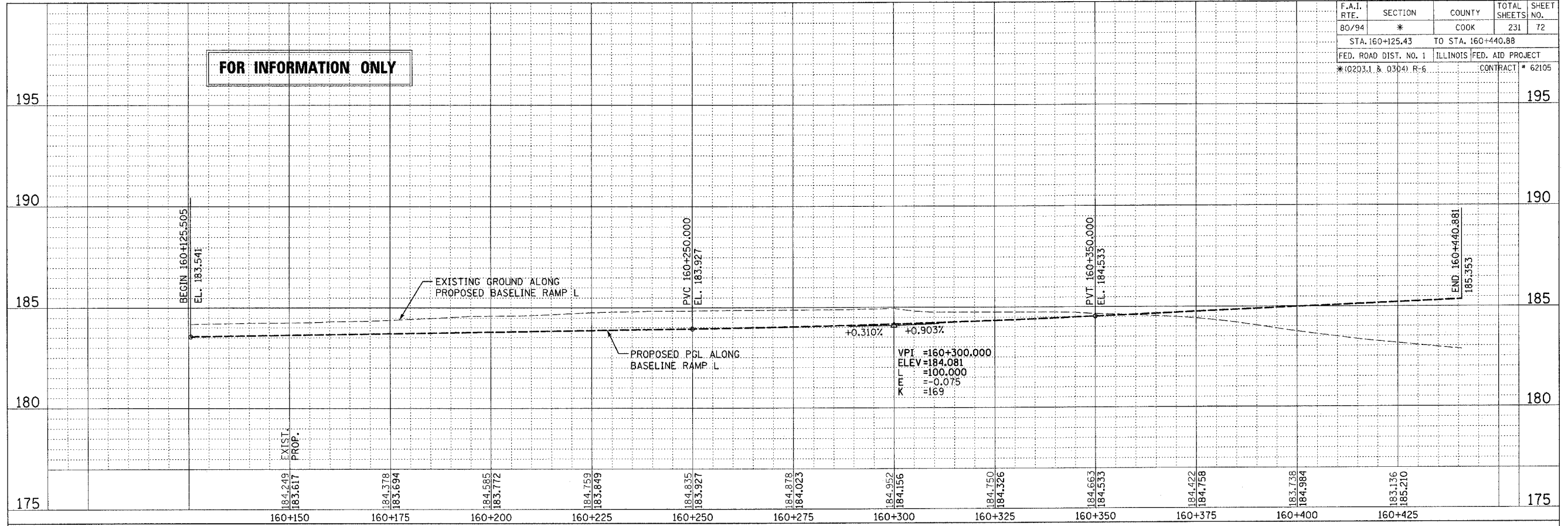

FINAL SURVEY	BY	DATE
SURVEYED		
PLOTTED		
NOTE BOOK		
NO.		

ORIGINAL SURVEY	BY	DATE
SURVEYED		
PLOTTED		
NOTE BOOK		
NO.		

REVISIONS		ILLINOIS DEPARTMENT OF TRANSPORTATION F.A.I. ROUTE 80/94 (INTERSTATE 80/294) RAMP L ROAD PROFILE STA. 160+125.43 TO STA. 160+440.88 HORIZ SCALE: 1 : 500 VERT SCALE: 1 : 100 DATE: JULY 18, 2005 DRAWN BY: CTT CHECKED BY: RCH
NAME	DATE	
McDonough Associates Inc. Engineers / Architects		

F.A.I. RTE.	SECTION	COUNTY	TOTAL SHEETS	SHEET NO.
80/94	*	COOK	231	73
STA. 180+081.02		TO STA. 180+282.74		
FED. ROAD DIST. NO. 1		ILLINOIS FED. AID PROJECT		
*10203.1 & 03041 R-6		CONTRACT # 62105		

BY	DATE
FINAL SURVEY PLOTTED	
NOTE BOOK NO.	
AREAS CHECKED	

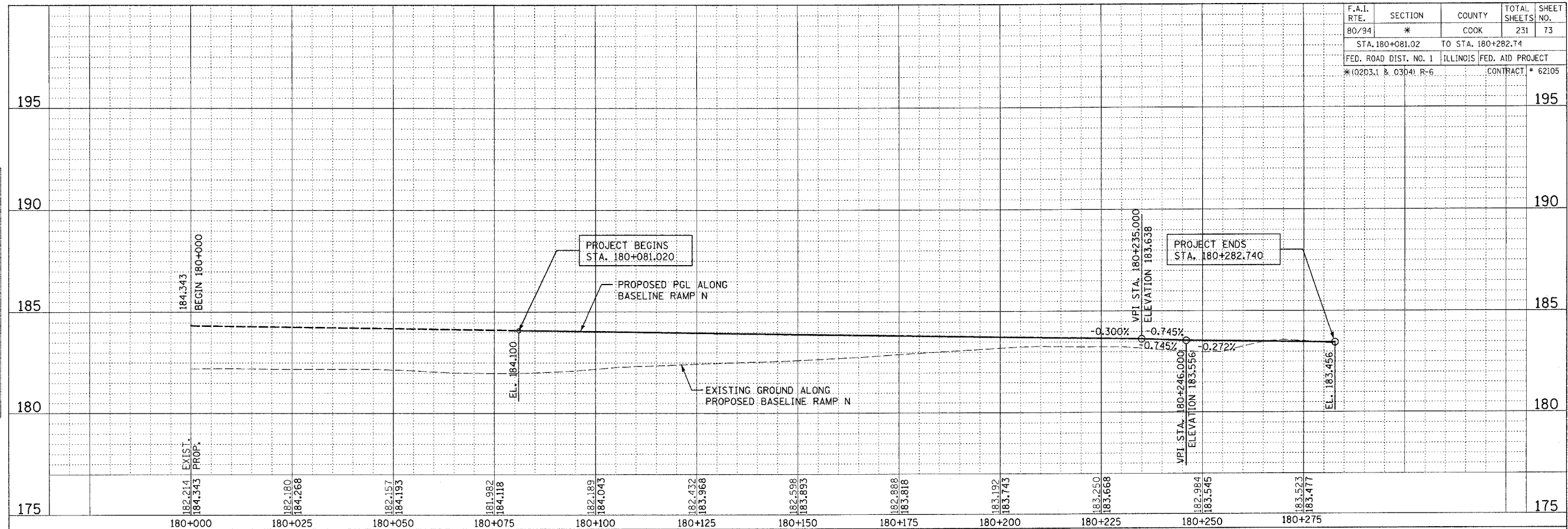

BY	DATE
ORIGINAL SURVEY PLOTTED	
NOTE BOOK NO.	
AREAS CHECKED	

REVISIONS		ILLINOIS DEPARTMENT OF TRANSPORTATION F.A.I. ROUTE 80/94 (INTERSTATE 80/294)
NAME	DATE	
		RAMP N ROAD PROFILE STA. 180+081.02 TO STA. 180+282.74
		HORIZ SCALE: 1 : 500
		VERT SCALE: 1 : 100
		DATE: JULY 18, 2005
		DRAWN BY: CTT
		CHECKED BY: RCH
		McDonough Associates Inc. Engineers / Architects

F.A.I. RTE.	SECTION	COUNTY	TOTAL SHEETS	SHEET NO.
80/94	*	COOK	231	74
STA. 130+367.00		TO STA. 130+882.00		
FED. ROAD DIST. NO. 1		ILLINOIS FED. AID PROJECT		
*(0203.1 & 0304) R-6		CONTRACT # 62105		

FOR INFORMATION ONLY

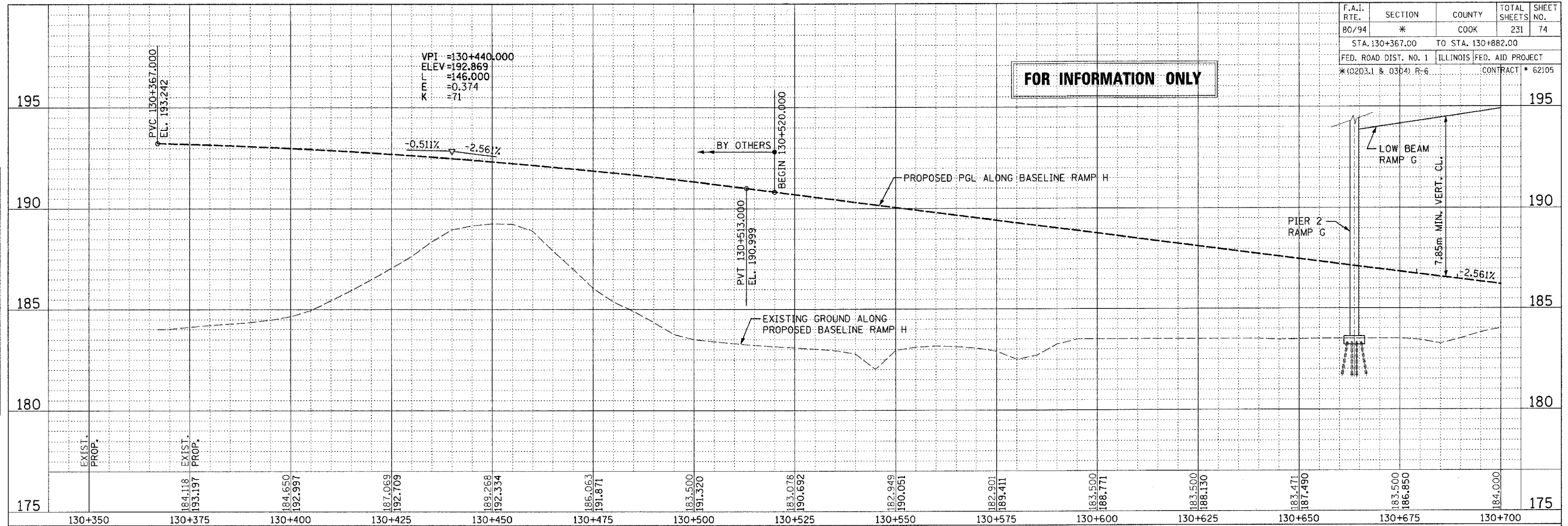

FINAL SURVEYED	BY	DATE
SURVEY PLOTTED		
NOTE BOOK TEMPLATE		
AREAS CHECKED		
NO.		

FOR INFORMATION ONLY

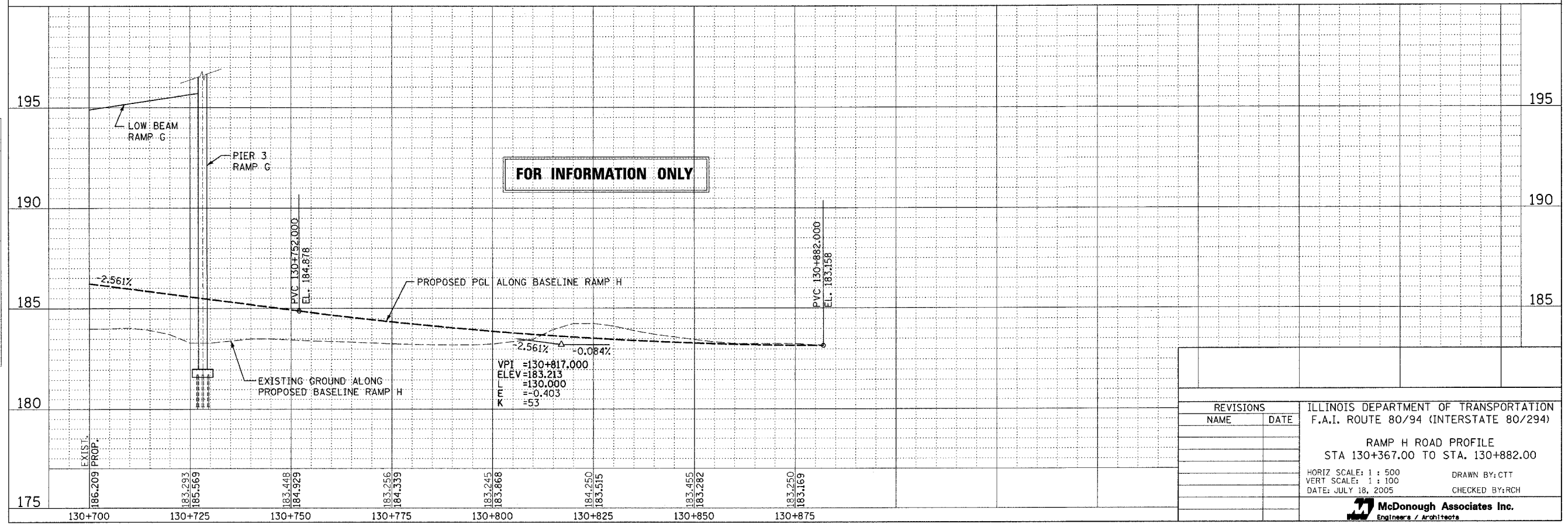

ORIGINAL SURVEYED	BY	DATE
SURVEY PLOTTED		
NOTE BOOK TEMPLATE		
AREAS CHECKED		
NO.		

REVISIONS		ILLINOIS DEPARTMENT OF TRANSPORTATION F.A.I. ROUTE 80/94 (INTERSTATE 80/294)
NAME	DATE	
		RAMP H ROAD PROFILE STA 130+367.00 TO STA. 130+882.00 HORIZ SCALE: 1 : 500 VERT SCALE: 1 : 100 DATE: JULY 18, 2005 DRAWN BY: CTT CHECKED BY: RCH McDonough Associates Inc. Engineers / Architects

F.A.I. RTE.	SECTION	COUNTY	TOTAL SHEETS	SHEET NO.
80/94	*	COOK	231	75
STA. 10+093.96		TO STA. 10+243.30		
FED. ROAD DIST. NO. 1		ILLINOIS		FED. AID PROJECT
*(02D3.1 & 03D4) R-6		CONTRACT # 62105		

FINAL SURVEY	SURVEYED	BY	DATE
NO. _____	NO. _____	_____	____/____/____
AREAS CHECKED	AREAS CHECKED		

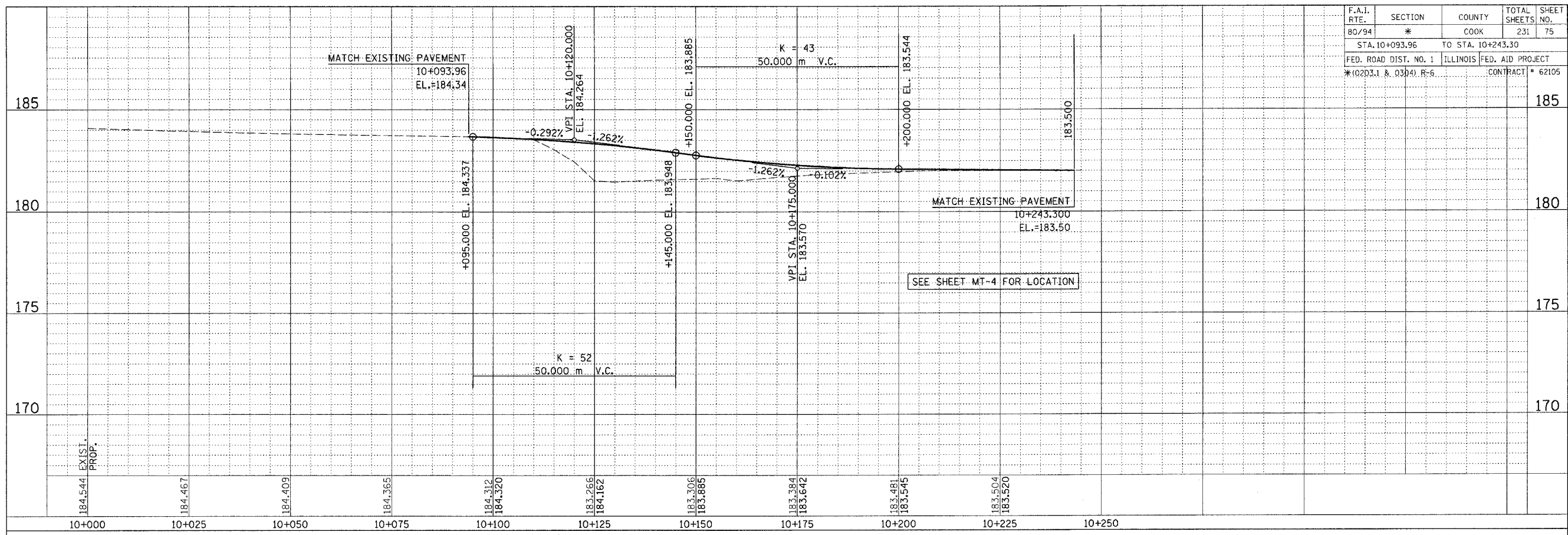

ORIGINAL SURVEY	SURVEYED	BY	DATE
NO. _____	NO. _____	_____	____/____/____
AREAS CHECKED	AREAS CHECKED		

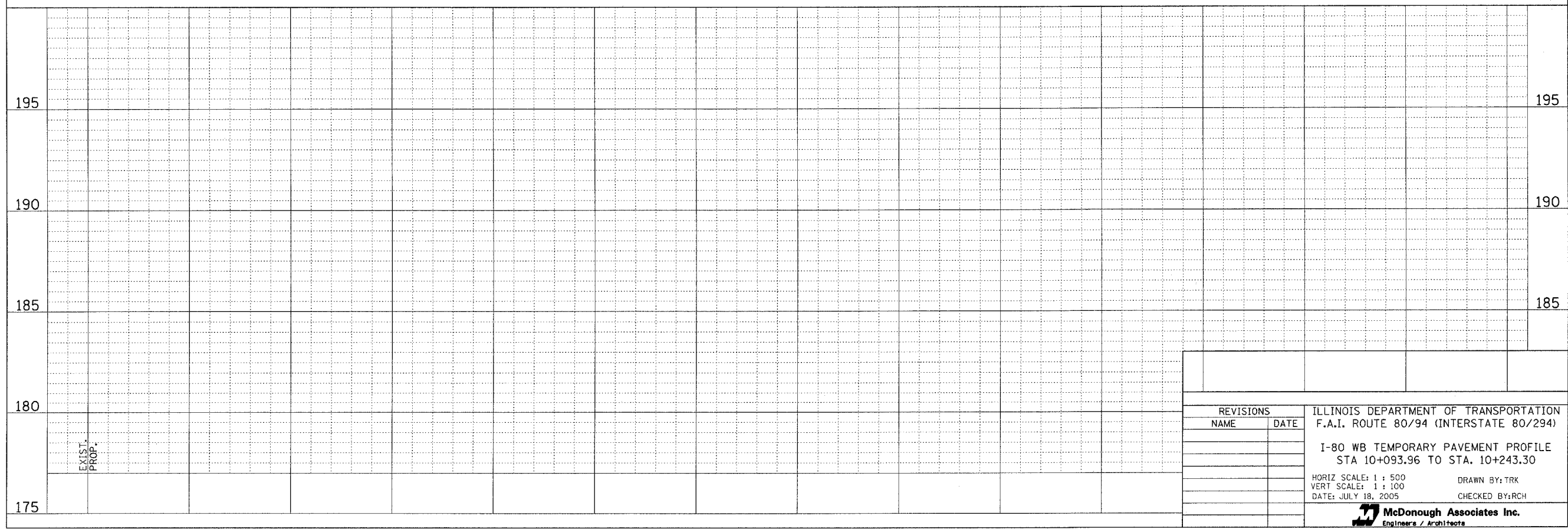

REVISIONS		ILLINOIS DEPARTMENT OF TRANSPORTATION F.A.I. ROUTE 80/94 (INTERSTATE 80/294) I-80 WB TEMPORARY PAVEMENT PROFILE STA 10+093.96 TO STA. 10+243.30 HORIZ SCALE: 1 : 500 VERT SCALE: 1 : 100 DATE: JULY 18, 2005 DRAWN BY: TRK CHECKED BY: RCH
NAME	DATE	

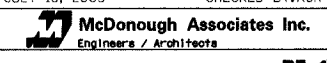

F.A.I. RTE.	SECTION	COUNTY	TOTAL SHEETS	SHEET NO.
80/94	*	COOK	231	76
STA. 2+967.681		TO STA. 3+100.00		
FED. ROAD DIST. NO. 1		ILLINOIS FED. AID PROJECT		
*(0203.1 & 0304) R-6		CONTRACT # 62105		

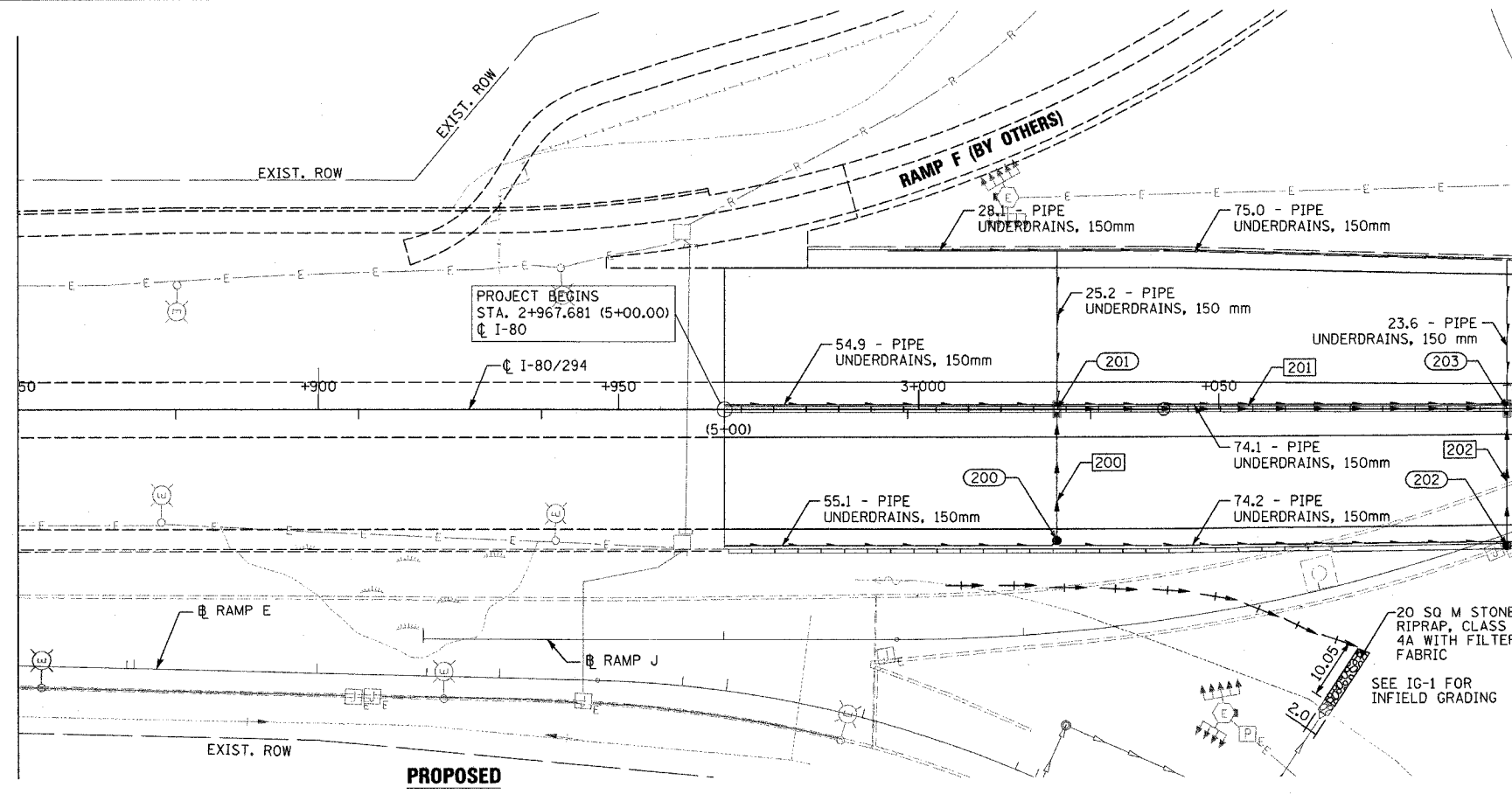
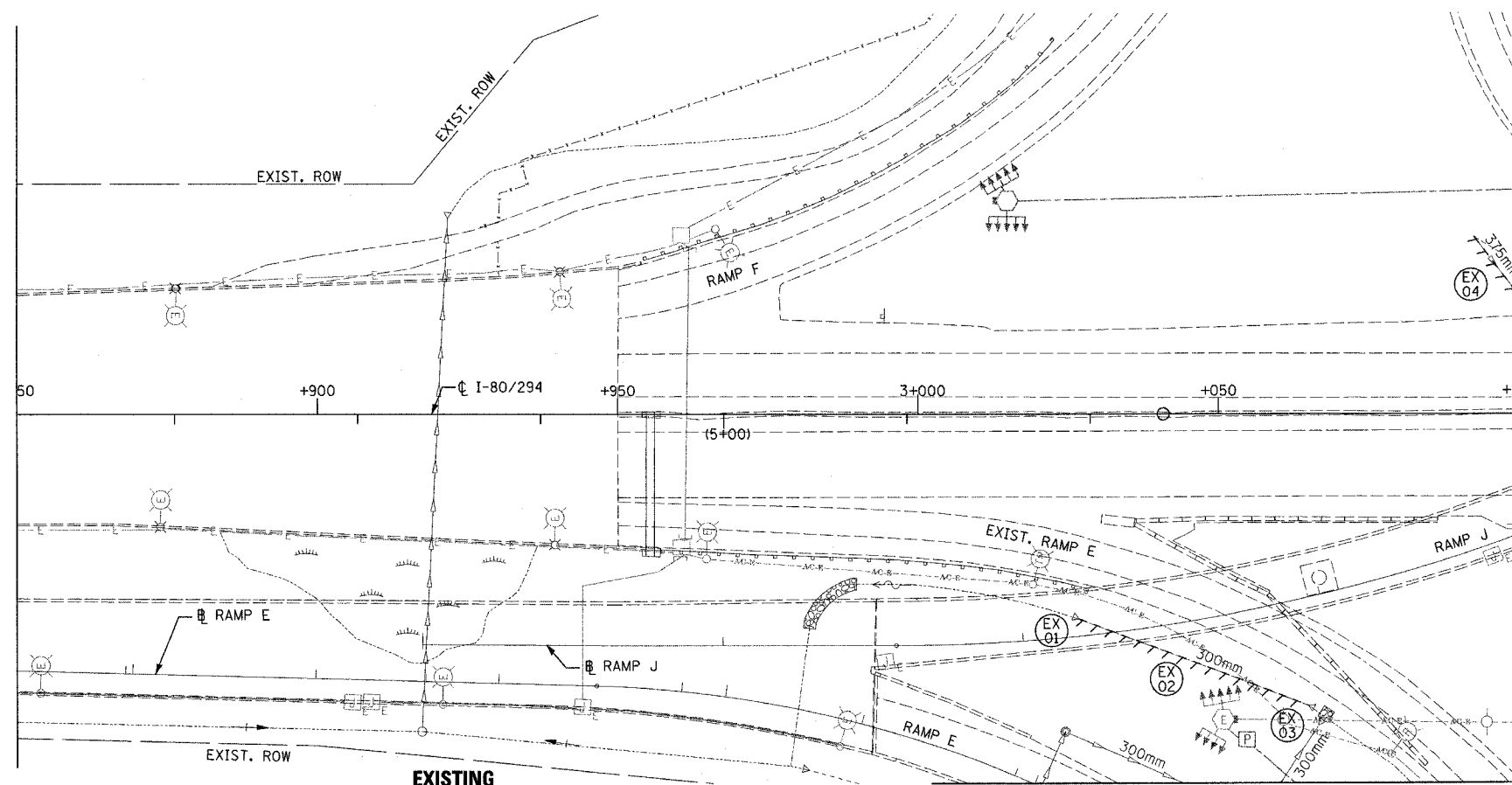

REVISIONS	
NAME	DATE

ILLINOIS DEPARTMENT OF TRANSPORTATION
F.A.I. ROUTE 80/94 (INTERSTATE 80/294)

EXISTING AND PROPOSED DRAINAGE PLAN
STA. 2+850.00 TO STA. 3+100.00

DATE: JULY 18, 2005

DRAWN BY: JWM
CHECKED BY: RCH

McDonough Associates Inc.
Engineers / Architects

F.A.I. RTE.	SECTION	COUNTY	TOTAL SHEETS	SHEET NO.
80/94	*	COOK	231	77
STA. 3+100.00		TO STA. 3+450.00		
FED. ROAD DIST. NO. 1		ILLINOIS FED. AID PROJECT		
*(0203.1 & 0304) R-6		CONTRACT # 62105		

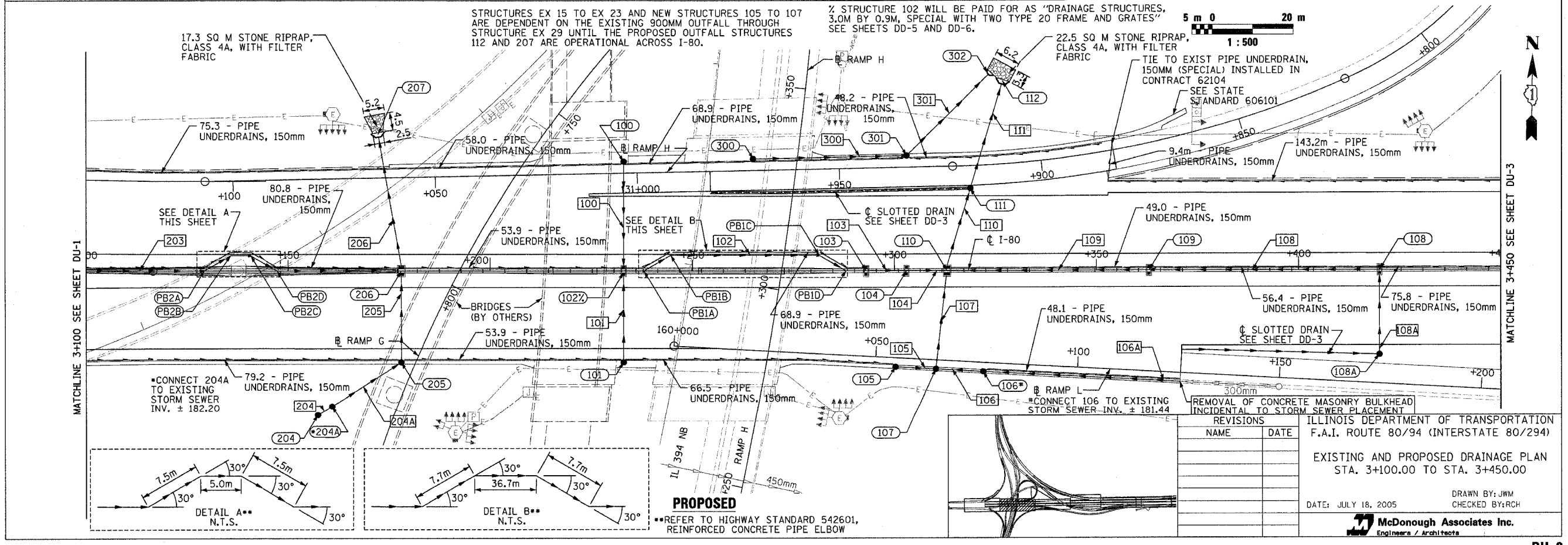
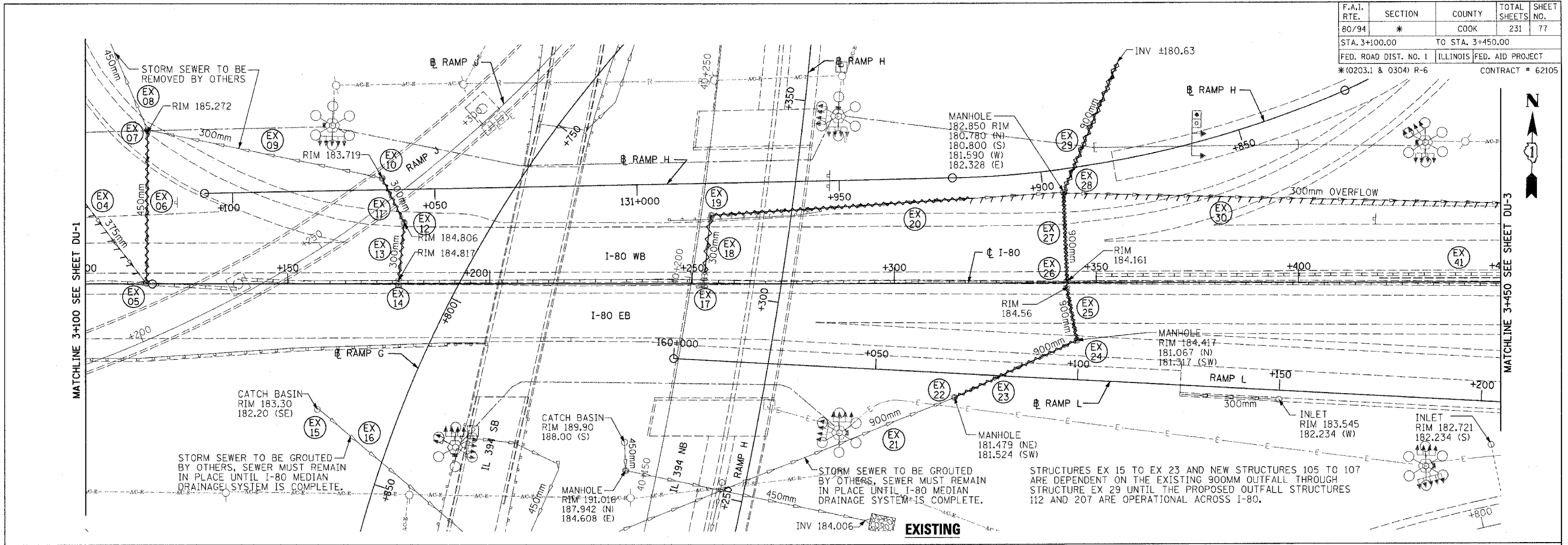

F.A.I. RTE.	SECTION	COUNTY	TOTAL SHEETS	SHEET NO.
80/94	*	COOK	231	78
STA. 3+450.00		TO STA. 3+800.00		
FED. ROAD DIST. NO. 1		ILLINOIS FED. AID PROJECT		
*10203.1 & 0304 R-6		CONTRACT # 62105		

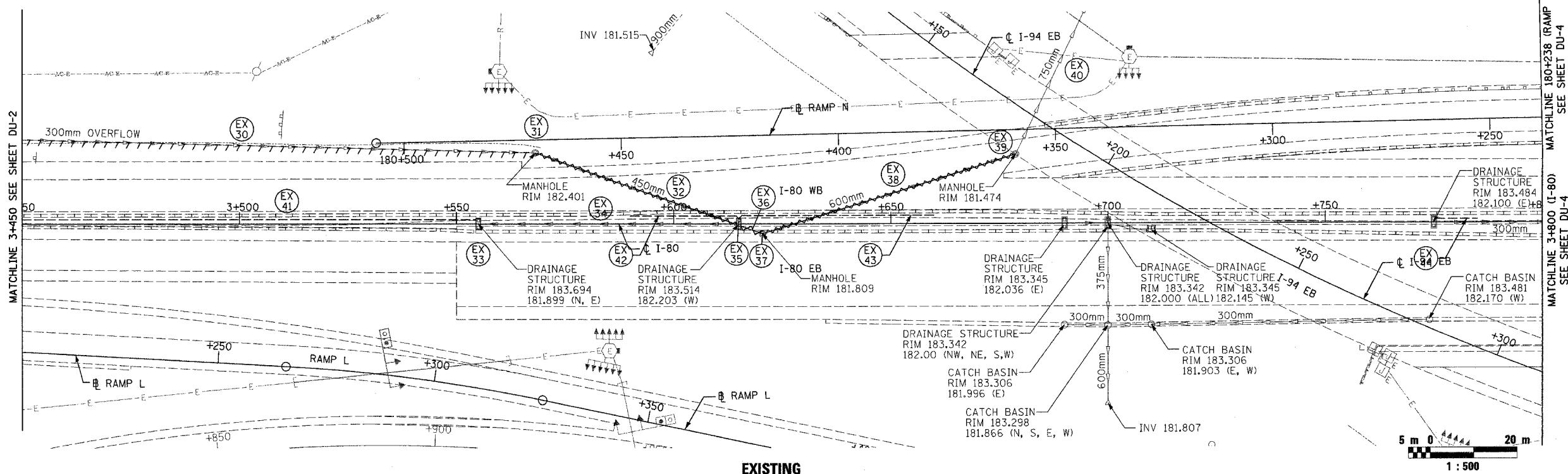

EXISTING

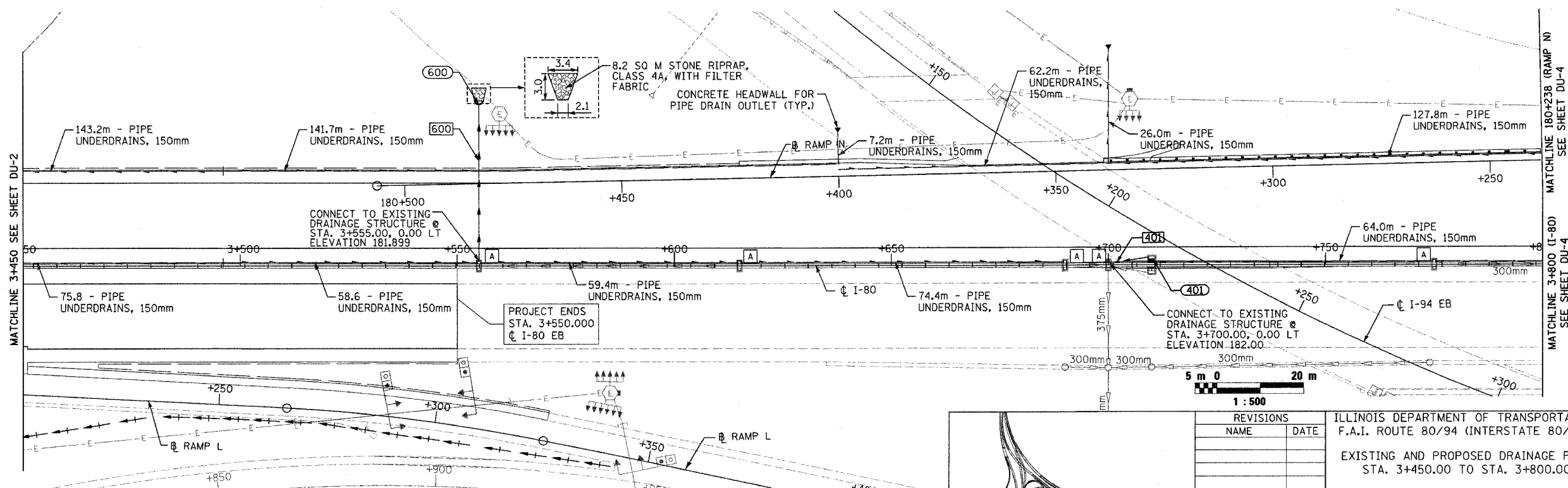

PROPOSED

REVISIONS	
NAME	DATE

ILLINOIS DEPARTMENT OF TRANSPORTATION
 F.A.I. ROUTE 80/94 (INTERSTATE 80/294)
 EXISTING AND PROPOSED DRAINAGE PLAN
 STA. 3+450.00 TO STA. 3+800.00
 DATE: JULY 18, 2005
 DRAWN BY: JWM
 CHECKED BY: RCH
McDonough Associates Inc.
 Engineers / Architects

F.A.I. RTE.	SECTION	COUNTY	TOTAL SHEETS	SHEET NO.
80/94	*	COOK	231	79
STA. 3+800.00		TO STA. 4+100.00		
FED. ROAD DIST. NO. 1		ILLINOIS FED. AID PROJECT		
*(0203.1 & 0304) R-6		CONTRACT # 62105		

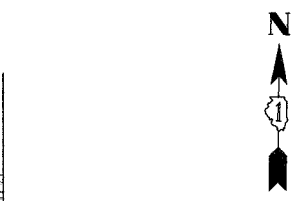
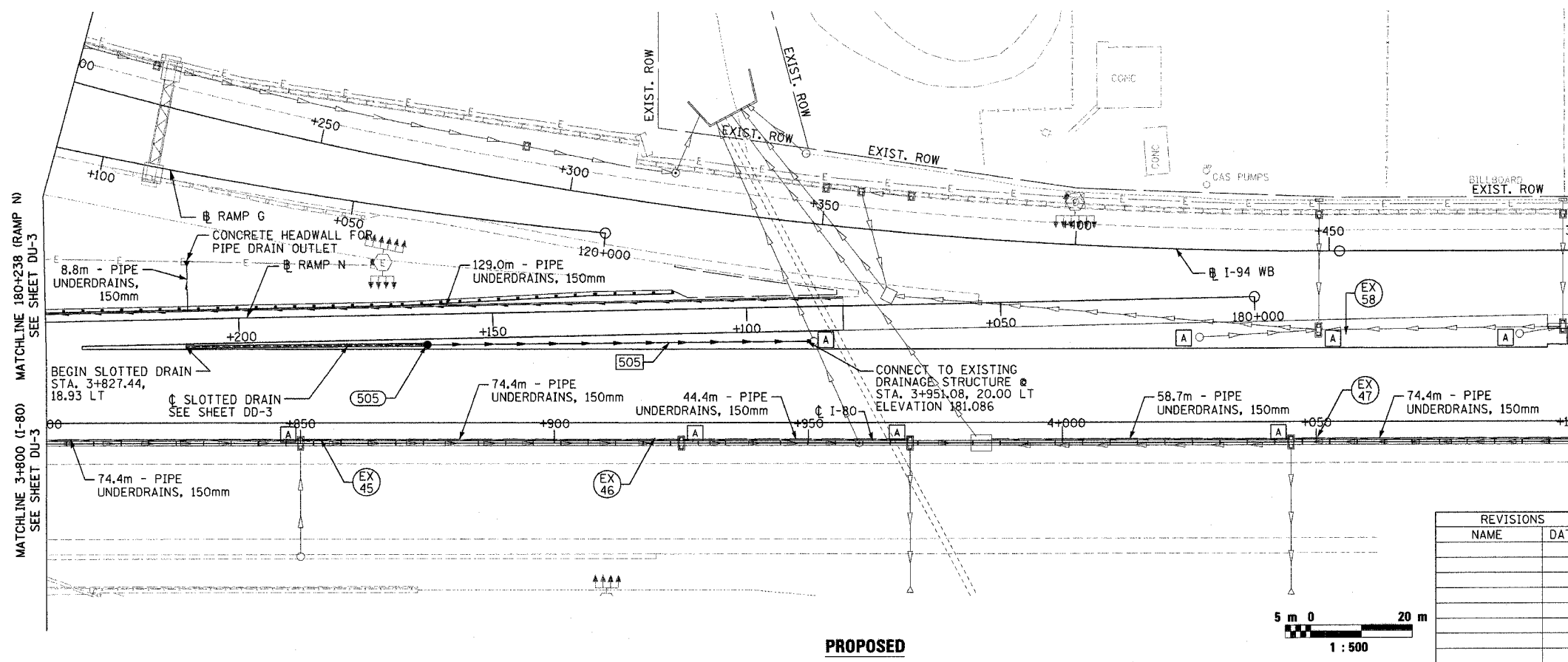
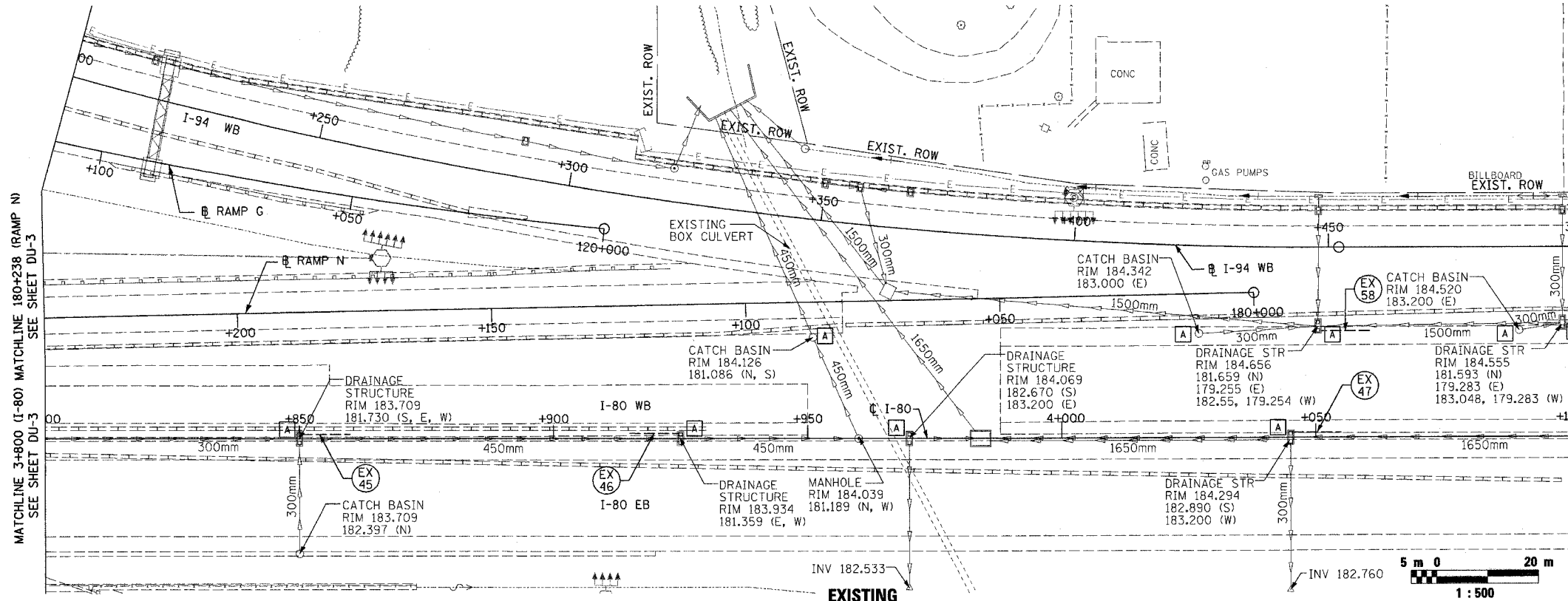

SEE SHEET DU-3
MATCHLINE 180+238 (RAMP N)

SEE SHEET DU-5
MATCHLINE 4+100 (I-80)

REVISIONS	
NAME	DATE

ILLINOIS DEPARTMENT OF TRANSPORTATION
F.A.I. ROUTE 80/94 (INTERSTATE 80/294)

EXISTING AND PROPOSED DRAINAGE PLAN
STA. 3+800.00 TO STA. 4+100.00

DATE: JULY 18, 2005
DRAWN BY: JWM
CHECKED BY: RCH

McDonough Associates Inc.
Engineers / Architects

F.A.I. RTE.	SECTION	COUNTY	TOTAL SHEETS	SHEET NO.
80/94	*	COOK	231	80
STA. 4+100.00		TO STA. 4+450.00		
FED. ROAD DIST. NO. 1		ILLINOIS FED. AID PROJECT		
*(0203.1 & 0304) R-6		CONTRACT # 62105		

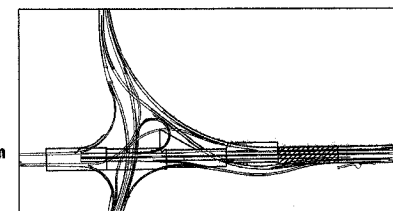
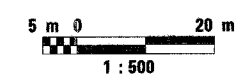
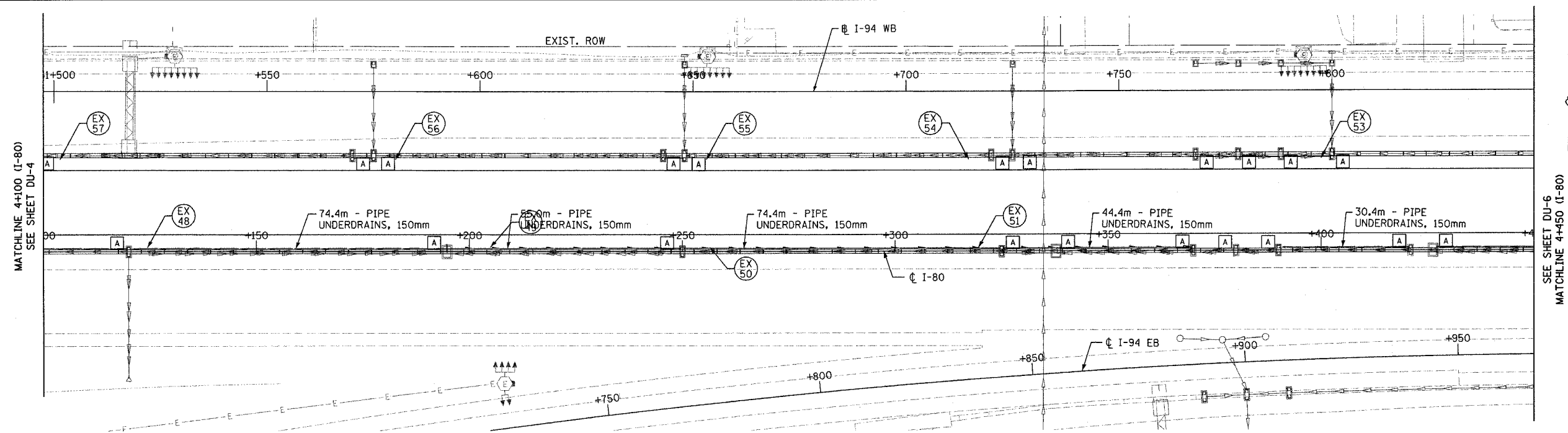
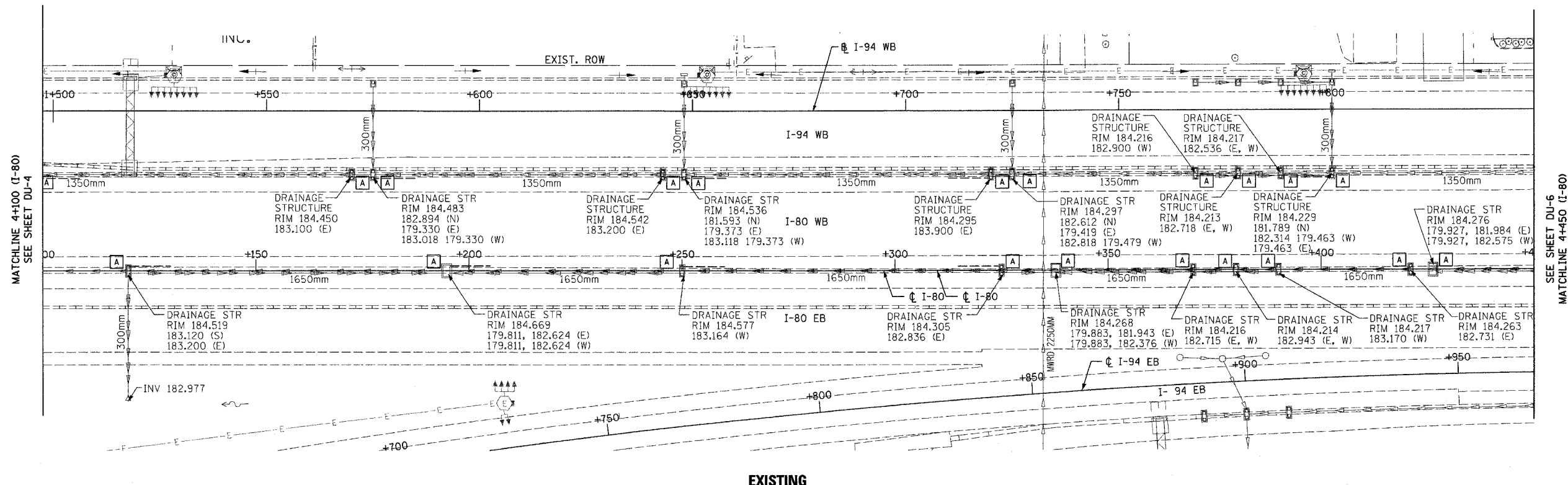

REVISIONS	
NAME	DATE

ILLINOIS DEPARTMENT OF TRANSPORTATION
F.A.I. ROUTE 80/94 (INTERSTATE 80/294)

EXISTING AND PROPOSED DRAINAGE PLAN
STA. 4+100.00 TO STA. 4+450.00

DATE: JULY 18, 2005

DRAWN BY: JWM
CHECKED BY: RCH

McDonough Associates Inc.
Engineers / Architects

F.A.I. RTE.	SECTION	COUNTY	TOTAL SHEETS	SHEET NO.
80/94	*	COOK	231	81
STA. 4+450.00		TO STA. 4+500.00		
FED. ROAD DIST. NO. 1		ILLINOIS FED. AID PROJECT		
*(0203.1 & 0304) R-6		CONTRACT # 62105		

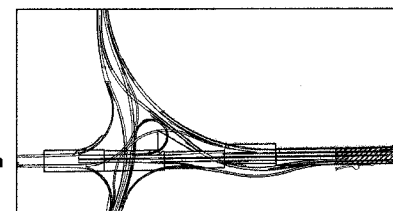
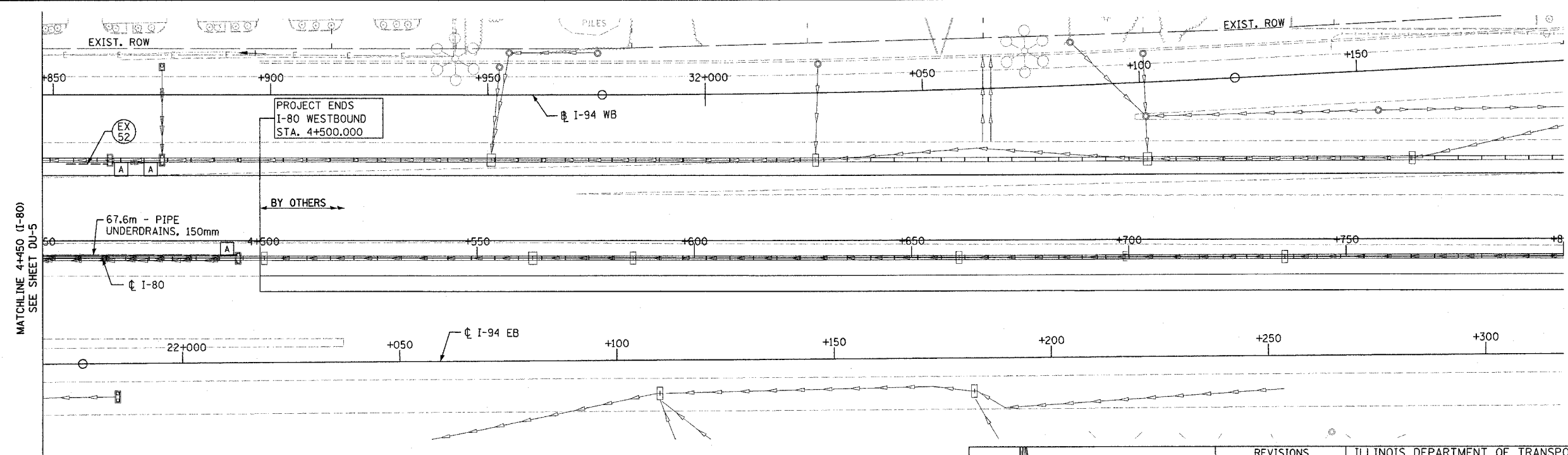
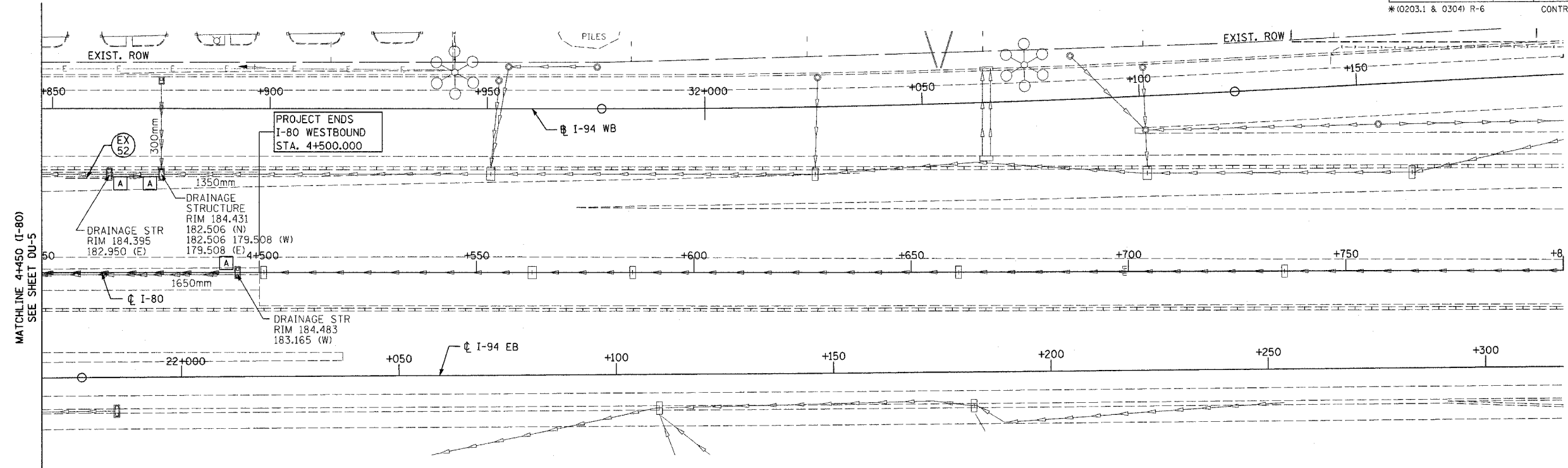

REVISIONS	
NAME	DATE

ILLINOIS DEPARTMENT OF TRANSPORTATION
F.A.I. ROUTE 80/94 (INTERSTATE 80/294)

EXISTING AND PROPOSED DRAINAGE PLAN
STA. 4+450.00 TO STA. 4+500.00

DATE: JULY 18, 2005

DRAWN BY: JWM
CHECKED BY: RCH

McDonough Associates Inc.
Engineers / Architects

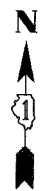

F.A.I. RTE.	SECTION	COUNTY	TOTAL SHEETS	SHEET NO.
80/94	*	COOK	231	82
STA. 2+967.681		TO STA. 3+400.00		
FED. ROAD DIST. NO. 1		ILLINOIS	FED. AID PROJECT	
*10203.1 & 03041 R-6		CONTRACT # 62105		

FINAL SURVEY PLOTTED	BY	DATE
NOTE BOOK TEMPLATE		
AREAS CHECKED		
NO.		

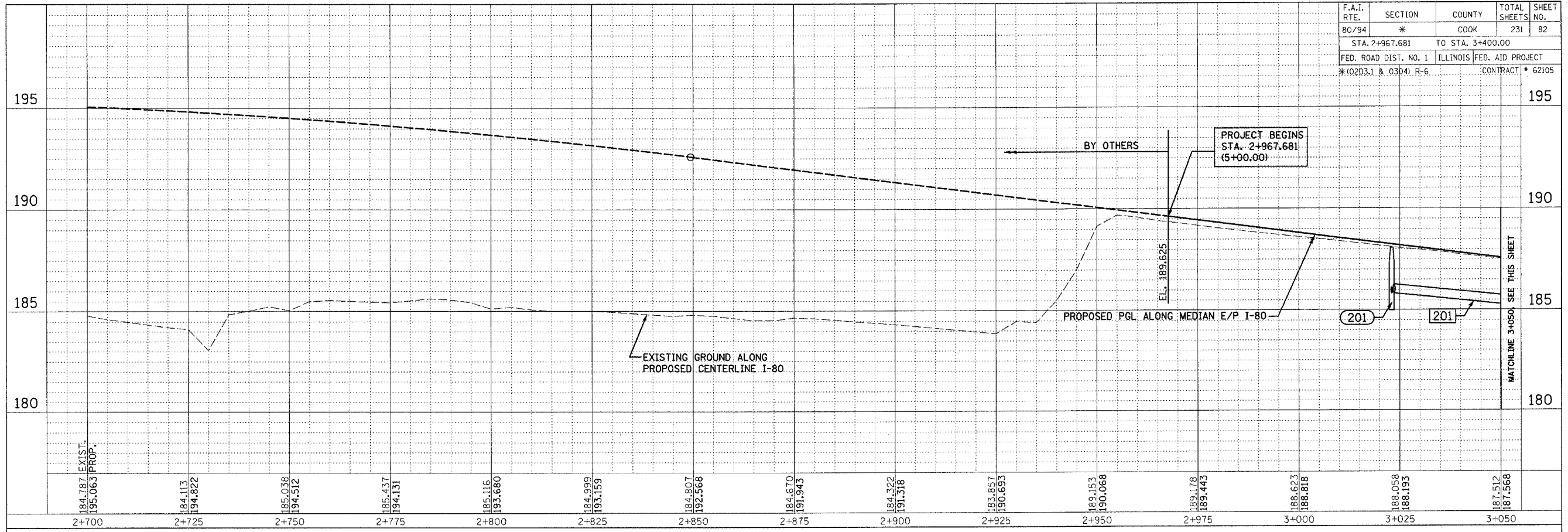

ORIGINAL SURVEY PLOTTED	BY	DATE
NOTE BOOK TEMPLATE		
AREAS CHECKED		
NO.		

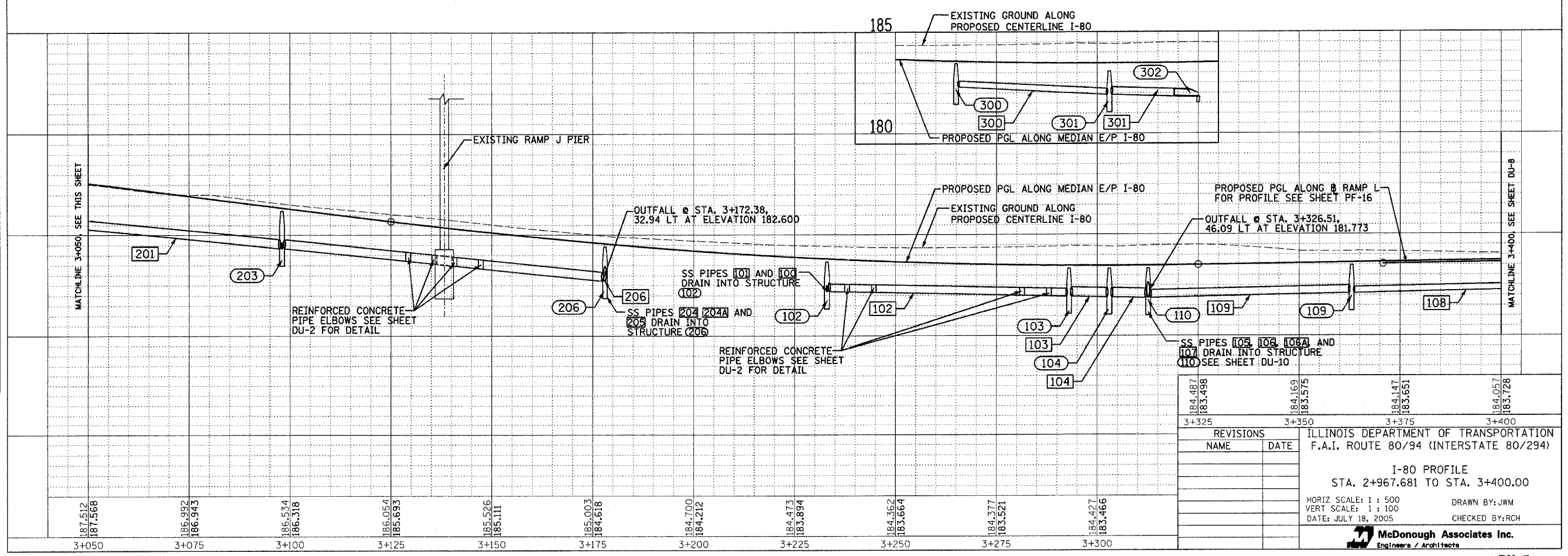

184.487	184.169	184.147	184.057
183.498	183.575	183.651	183.728
3+325	3+350	3+375	3+400
REVISIONS			
NAME	DATE		
ILLINOIS DEPARTMENT OF TRANSPORTATION			
F.A.I. ROUTE 80/94 (INTERSTATE 80/294)			
I-80 PROFILE			
STA. 2+967.681 TO STA. 3+400.00			
HORIZ SCALE: 1 : 500		DRAWN BY: JWM	
VERT SCALE: 1 : 100		DATE: JULY 18, 2005	
		CHECKED BY: RCH	
McDonough Associates Inc.			
Engineers / Architects			

F.A.I. RTE. 80/94	SECTION *	COUNTY COOK	TOTAL SHEETS 231	SHEET NO. 83
STA. 3+400.00		TO STA. 4+100.00		
FED. ROAD DIST. NO. 1		ILLINOIS FED. AID PROJECT		
*10203.1 & 0304 R-6			CONTRACT # 62105	

FINAL SURVEY PLOTTED	BY	DATE
NOTE BOOK TEMPLATE		
AREAS CHECKED		
NO.		

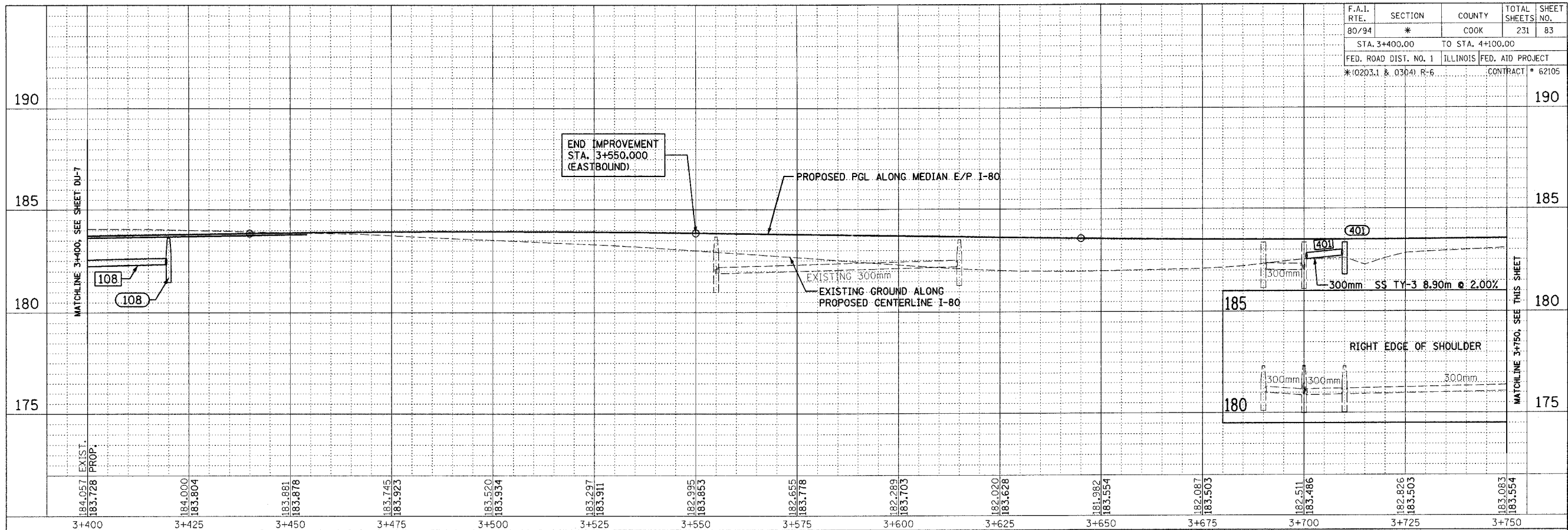

ORIGINAL SURVEY PLOTTED	BY	DATE
NOTE BOOK TEMPLATE		
AREAS CHECKED		
NO.		

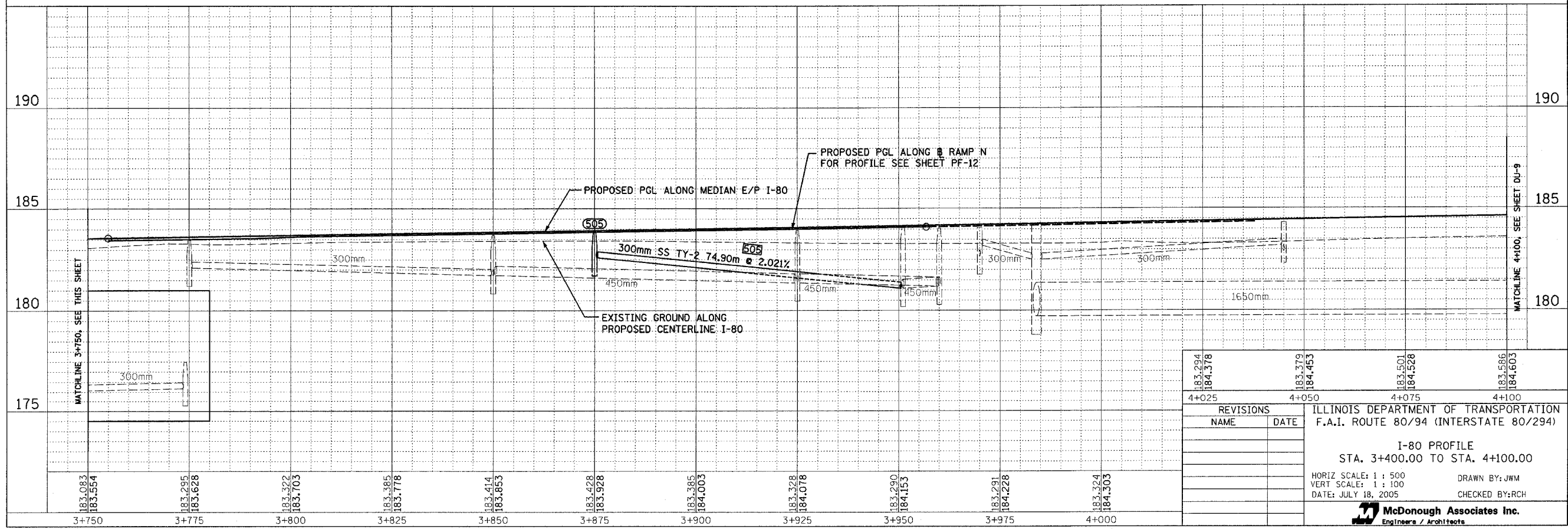

183.294	183.379	183.501	183.586
184.378	184.453	184.528	184.603
4+025	4+050	4+075	4+100
REVISIONS		ILLINOIS DEPARTMENT OF TRANSPORTATION	
NAME	DATE	F.A.I. ROUTE 80/94 (INTERSTATE 80/294)	
		I-80 PROFILE	
		STA. 3+400.00 TO STA. 4+100.00	
		HORIZ SCALE: 1 : 500	
		VERT SCALE: 1 : 100	
		DATE: JULY 18, 2005	
		DRAWN BY: JWM	
		CHECKED BY: RCH	
McDonough Associates Inc. Engineers / Architects			

DU-8

F.A.I. RTE. 80/94	SECTION *	COUNTY COOK	TOTAL SHEETS 231	SHEET NO. 84
STA. 4+100.00		TO STA. 4+500.00		
FED. ROAD DIST. NO. 1		ILLINOIS	FED. AID PROJECT	
*10203.1 & 03041 R-6		CONTRACT # 62105		

BY	DATE
FINAL SURVEYED	
SURVEY PLOTTED	
NOTE BOOK TEMPLATE	
AREAS CHECKED	
NO.	

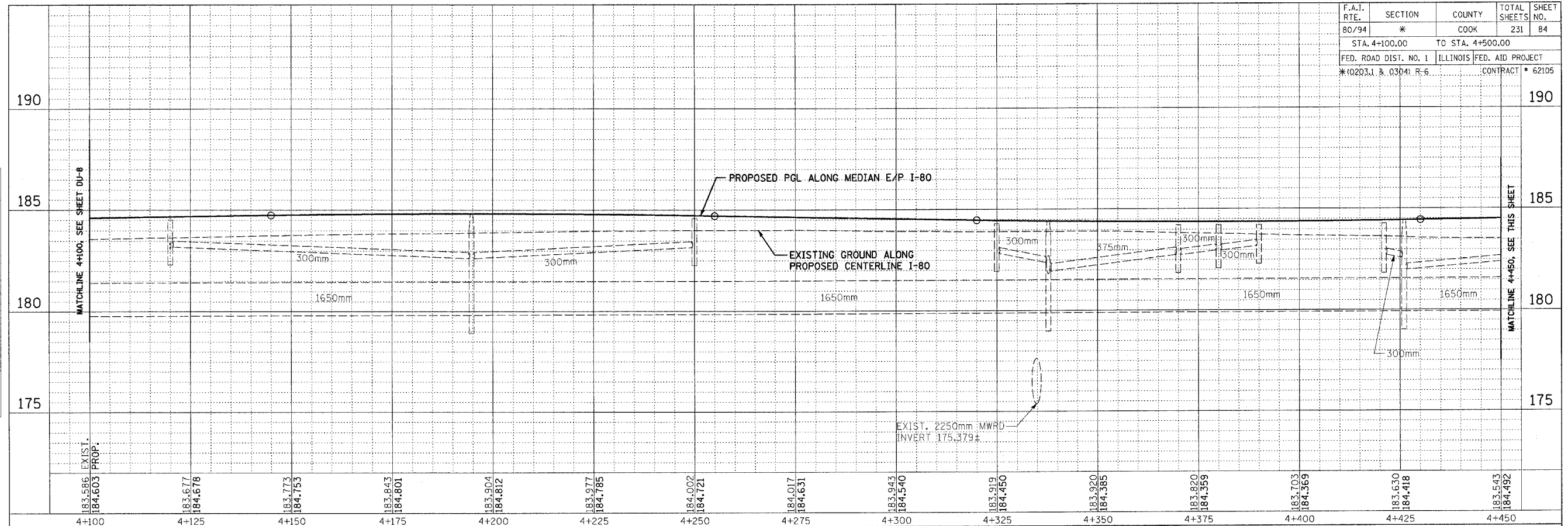

BY	DATE
ORIGINAL SURVEYED	
SURVEY PLOTTED	
NOTE BOOK TEMPLATE	
AREAS CHECKED	
NO.	

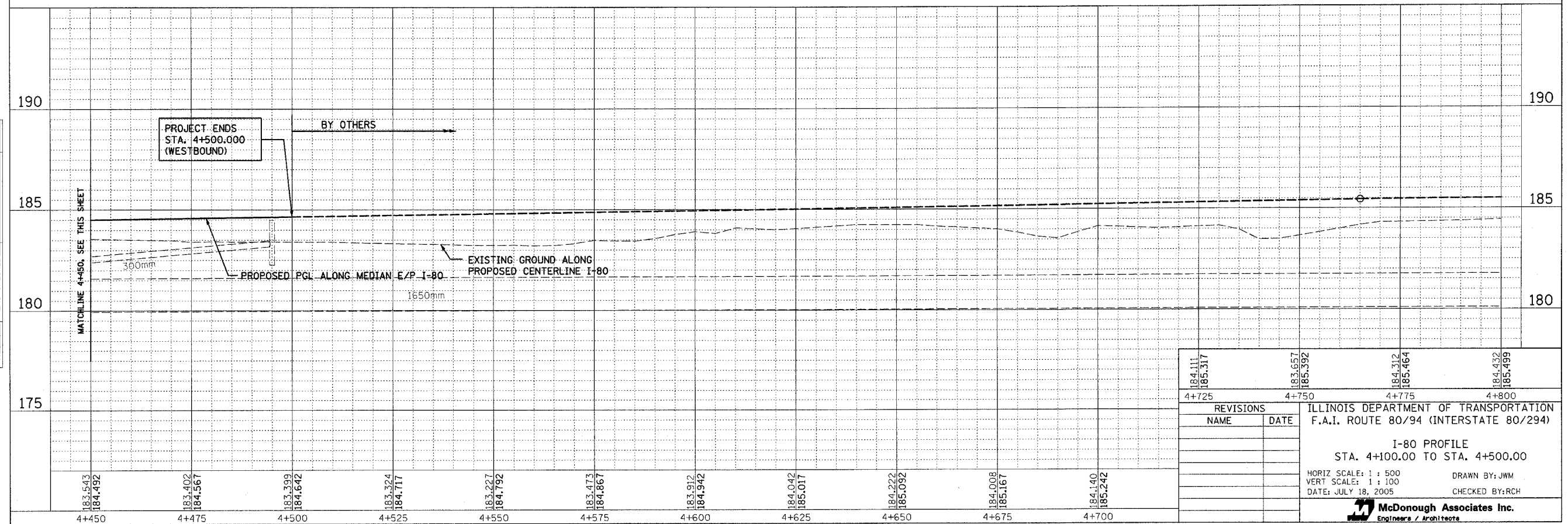

184.111	183.657	184.312	184.432
185.317	185.392	185.464	185.499
4+725	4+750	4+775	4+800
REVISIONS			
NAME	DATE	ILLINOIS DEPARTMENT OF TRANSPORTATION	
		F.A.I. ROUTE 80/94 (INTERSTATE 80/294)	
		I-80 PROFILE	
		STA. 4+100.00 TO STA. 4+500.00	
		HORIZ SCALE: 1 : 500	DRAWN BY: JWM
		VERT SCALE: 1 : 100	DATE: JULY 18, 2005
			CHECKED BY: RCH
 McDonough Associates Inc. Engineers / Architects			

F.A.I. RTE.	SECTION	COUNTY	TOTAL SHEETS	SHEET NO.
80/94	*	COOK	231	85
STA. 160+000.00		TO STA. 160+440.88		
FED. ROAD DIST. NO. 1		ILLINOIS FED. AID PROJECT		
*10203.1 & 0304 R-6		CONTRACT # 62105		

FINAL SURVEY	BY	DATE
SURVEY PLOTTED		
NOTE BOOK TEMPLATE		
AREAS CHECKED		
NO.		

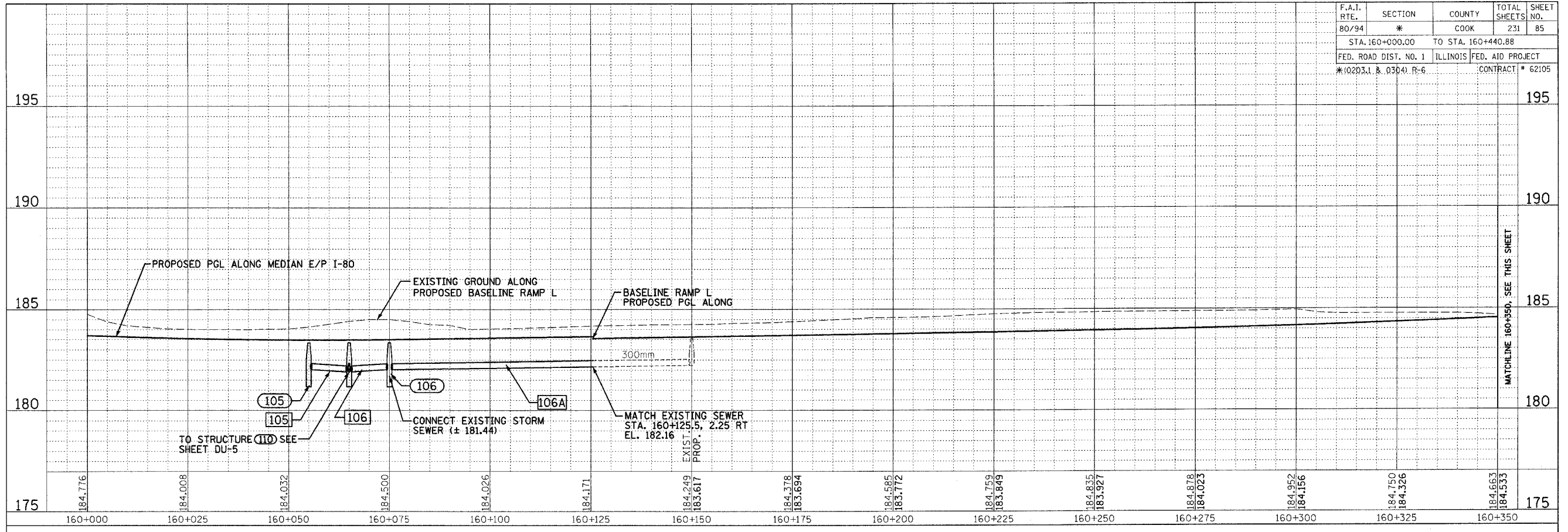

ORIGINAL SURVEY	BY	DATE
SURVEY PLOTTED		
NOTE BOOK TEMPLATE		
AREAS CHECKED		
NO.		

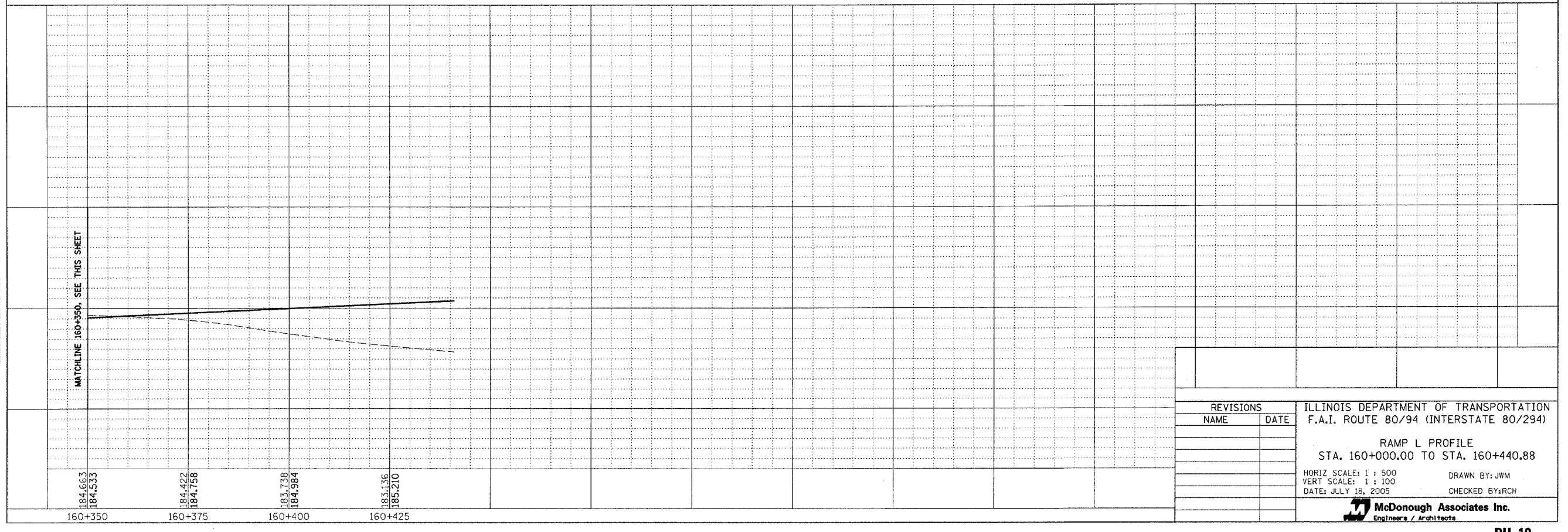

REVISIONS		ILLINOIS DEPARTMENT OF TRANSPORTATION F.A.I. ROUTE 80/94 (INTERSTATE 80/294)
NAME	DATE	
		RAMP L PROFILE STA. 160+000.00 TO STA. 160+440.88
		HORIZ SCALE: 1 : 500 VERT SCALE: 1 : 100 DATE: JULY 18, 2005
		DRAWN BY: JWM CHECKED BY: RCH
		McDonough Associates Inc. Engineers / Architects

DU-10

XXX PROPOSED DRAINAGE STRUCTURE SCHEDULE

STR. NUM.	REF. NUM.	STATION	OFFSET (m)	R C PIPE ELBOW 375 EACH	R C PIPE ELBOW 450 EACH	DR STR 3.0m X 0.9m SP 2T20F&G EACH	CB A 1.2M T20F&G EACH	CB A 1.5M T8G EACH	CB A 1.5M D T20F&G EACH	CB 1.2X1.5 T22F&G EACH	DR STR T1 SP 2T20F&G EACH	DR STR T2 SP 2T22F&G EACH	CONCRETE HEADWALL EACH	SLIP-ON CK VALVE 375 EACH	SLIP-ON CK VALVE 750 EACH	RIM ELEV.	N	S	W	E	COMMENTS		
100	DU-2	3+233.00	27.00 LT				1									183.649		182.338					
101	DU-2	3+233.00	22.53 RT				1									183.667	182.356					N. INV. TO BE PLUGGED UNTIL SS IS COMPLETED IN STAGE II	
102	DU-2	3+233.00	0.00			1										183.667	182.193	182.193		182.193		SEE SHEETS DD-5 AND DD-6 FOR DETAILS	
PB1A	DU-2	3+238.00	0.00	1												N/A							
PB1B	DU-2	3+244.64	3.84 LT	1												N/A							
PB1C	DU-2	3+281.36	3.84 LT	1												N/A							
PB1D	DU-2	3+288.00	0.00	1												N/A							
103	DU-2	3+293.00	0.00								1					183.329		181.947	181.947			SEE SHET DS-4 & DS-5	
104	DU-2	3+303.00	0.00								1					183.321		181.909	181.947			SEE SHET DS-4 & DS-5	
105	DU-2	3+300.26	23.72 RT				1									183.334				182.024			
107	DU-2	3+310.24	24.27 RT				1									183.326	181.905		181.905	181.905		N. INV. TO BE PLUGGED UNTIL SS IS COMPLETED IN STAGE II	
106	DU-2	3+321.95	24.90 RT				1									183.331		181.946	181.946			CONNECT TO EXISTING STORM SEWER (±181.44)	
108A	DU-2	3+420.00	20.78 RT				1									183.695	182.719		*	*		* SEE DD-3 FOR SLOTTED DRAIN CONNECTION DETAIL	
108	DU-2	3+420.00	0.00								1					183.645		182.334	182.334			SEE SHET DS-4 & DS-5	
109	DU-2	3+363.00	0.00								1					183.471		182.087	182.087			SEE SHET DS-4 & DS-5	
110	DU-2	3+313.00	0.00									1				183.328	181.871	181.871	181.871	181.871		SEE SHET DS-4 & DS-5	
111	DU-2	3+318.77	20.34 LT						1							183.404	181.828	181.828					
112	DU-2	3+326.51	46.09 LT										1		1	N/A		181.773				SEE DD-4 AND SPECIAL PROVISIONS	
200	DU-1	3+023.00	21.76 RT				1									188.105	186.215						
201	DU-1	3+023.00	0.00								1					188.074		185.815		185.815		SEE SHET DS-4 & DS-5	
202	DU-1	3+098.00	22.73 RT				1									186.224	184.751					CLOSE W/ STEEL PLATE UNTIL SS IS COMPLETED IN STAGE II	
203	DU-1	3+098.00	0.00								1					186.217		184.333	184.333	184.333		SEE SHET DS-4 & DS-5	
PB2A	DU-2	3+129.24	0.00		1											N/A							
PB2B	DU-2	3+135.75	3.76 LT		1											N/A							
PB2C	DU-2	3+140.75	0.38 LT		1											N/A							
PB2D	DU-2	3+147.25	0.00		1											N/A							
204	DU-2	3+157.33	35.98 RT						1							185.500				182.846			
204A	DU-2	3+160.88	33.67 RT						1							185.500		182.837	182.837			CONNECT TO EXISTING STORM SEWER (±182.20)	
205	DU-2	3+178.00	22.53 RT						1							184.494	182.775		182.837			ALSO SEE SHEETS DS-4 & DS-5	
206	DU-2	3+178.00	0.00								1					184.420	182.713	182.713	182.713			N. INV. TO BE PLUGGED UNTIL SS IS COMPLETED IN STAGE II	
207	DU-2	3+172.38	32.94 LT										1		1	N/A		182.614				SEE DD-4 AND SPECIAL PROVISIONS	
300	DU-2	3+265.00	27.63 LT				1									183.447				182.286			
301	DU-2	3+303.00	28.40 LT				1									183.059		181.898	181.898				
302	DU-2	3+324.95	46.96 LT										1	1		N/A		181.773				SEE DD-4 AND SPECIAL PROVISIONS	
401	DU-3	3+710.00	1.41 LT							1						183.345				182.178		SEE SHEET DS-3	
505	DU-5	3+875.00	19.34 LT				1									183.911			&	182.600		&=SEE DD-3 FOR SLOTTED DRAIN INVERT AND CONNECTION	
600	DU-3	3+555.00	37.11 LT										1	1		N/A		181.715				SEE DD-4 AND SPECIAL PROVISIONS	
				TOTAL	4	4	1	11	2	2	1	6	2	4	2	2							

DU-11

REVISIONS		ILLINOIS DEPARTMENT OF TRANSPORTATION	
NAME	DATE	F.A.I. ROUTE 80/94 (INTERSTATE 80/294)	
DATE: JULY 18, 2005		DRAWN BY: JWM	
		CHECKED BY: RCH	
 McDonough Associates Inc. Engineers / Architects			

F.A.I. RTE.	SECTION	COUNTY	TOTAL SHEETS	SHEET NO.
80/94	*	COOK	231	87
STA.	TO STA.			
FED. ROAD DIST. NO. 1	ILLINOIS	FED. AID PROJECT		
*(0203.1 & 0304) R-6			CONTRACT # 62105	

XXX PROPOSED DRAINAGE PIPE SCHEDULE

PIPE NUM.	SS 2 RCP CL 3 300 METER	SS 2 RCP CL 3 375 METER	SS 2 RCP CL 3 450 METER	SS 2 RCP CL 3 600 METER	SS 2 RCP CL 3 750 METER	TRENCH BACKFILL (CU M.)	PIPE SLOPE (%)	COMMENTS
100	25.20					9	0.58%	
101	20.70					7	0.79%	
102		59.10				20	0.42%	
103			9.10			3	0.42%	
104			9.10			3	0.42%	
105	8.80					3	1.35%	
107			22.60			7	0.15%	
106	8.80					3	0.40%	
106A	72.10					42	0.40%	
108A	19.00					6	2.03%	
108	56.10					16	0.44%	
109		49.10				17	0.44%	
110					19.40	0	0.22%	
111					26.30	0	0.21%	
200	20.00					19	2.00%	
201			74.1			73	2.00%	
202	20.9					13	2.00%	
203			81.0			54	2.00%	
204				2.7		-	0.33%	
204A				19.1		-	0.33%	
205					20.7	13	0.30%	
206					33.4	21	0.30%	
300	36.8					9	1.05%	
301		27.8				0	0.45%	
401	8.9					3	2.00%	CONNECT TO EXISTING STRUCTURE AT STA. 3+700.00, EL 182.00
505	47.0					127	0.30%	CONNECT TO EXISTING STRUCTURE AT STA. 3+951.08, EL 181.086
600		35.9				17	0.51%	CONNECT TO EXISTING STRUCTURE AT STA. 3+555.00, EL 181.899
TOTAL*	344.5	172.0	196.0	22.0	100.0	485		

*ROUNDED TO NEAREST 0.5m

M6010610 PIPE UNDERDRAINS 150MM

SHEET NO.	BEGIN STATION	END STATION	OFFSET	LENGTH	COMMENTS
DU-1	2+967.7	3+022.6	LEFT	54.9	I-80, NEAR CENTER
DU-1	3+023.5	3+097.6	LEFT	74.1	I-80, NEAR CENTER
DU-1	2+994.9	3+023.0	FAR LT	28.1	I-80, LEFT EDGE
DU-1	3+023.0	3+098.0	FAR LT	75.0	I-80, LEFT EDGE
DU-1	2+967.7	3+022.8	RIGHT	55.1	I-80, RIGHT EDGE
DU-1	3+023.4	3+097.6	RIGHT	74.2	I-80, RIGHT EDGE
DU-1	3+023.0	-	LEFT	25.2	I-80, LATERAL PIPE
DU-1	3+098.0	-	LEFT	23.6	I-80, LATERAL PIPE
DU-2	3+098.0	3+127.3	LEFT	80.8	I-80, NEAR CENTER
DU-2	3+178.8	3+232.7	LEFT	53.9	I-80, NEAR CENTER
DU-2	3+233.5	3+292.7	LEFT	68.9	I-80, NEAR CENTER
DU-2	3+313.9	3+362.9	LEFT	49.0	I-80, NEAR CENTER
DU-2	3+363.3	3+419.7	LEFT	56.4	I-80, NEAR CENTER
DU-2,3	3+420.3	3+496.1	LEFT	75.8	I-80, NEAR CENTER
DU-2	3+098.0	3+173.3	FAR LT	75.3	I-80, LEFT EDGE
DU-2	3+174.3	3+232.3	FAR LT	58.0	I-80, LEFT EDGE
DU-2	3+233.0	3+301.9	FAR LT	68.9	I-80, LEFT EDGE
DU-2	3+303.5	3+351.4	FAR LT	48.2	I-80, LEFT EDGE
DU-2	3+098.5	3+177.7	RIGHT	79.2	I-80, RIGHT EDGE
DU-2	3+178.7	3+232.6	RIGHT	53.9	I-80, RIGHT EDGE
DU-2	3+233.5	3+300.0	RIGHT	66.5	I-80, RIGHT EDGE
DU-2	3+322.7	3+370.8	RIGHT	48.1	I-80, RIGHT EDGE
DU-2	3+352.9	-	FAR LT	9.4	LATERAL PIPE, TIES TO EXIST UD FROM 62104
DU-2,3	3+352.9	3+496.1	FAR LT	143.2	I-80, LEFT EDGE
DU-3	3+496.1	3+637.8	FAR LT	141.7	I-80, LEFT EDGE
DU-3	180+400.0	-	RIGHT	7.2	RAMP N, LATERAL PIPE
DU-3	180+400.0	180+337.8	RIGHT	62.2	RIGHT EDGE OF RAMP N
DU-3	3+496.1	3+554.7	LEFT	58.6	I-80, NEAR CENTER
DU-3	3+555.3	3+614.7	LEFT	59.4	I-80, NEAR CENTER
DU-3	3+615.3	3+689.7	LEFT	74.4	I-80, NEAR CENTER
DU-3	3+710.6	3+774.6	LEFT	64.0	I-80, NEAR CENTER
DU-3	180+337.8	-	RIGHT	26.0	RAMP N, LATERAL PIPE
DU-3,4	3+775.3	3+849.7	LEFT	74.4	I-80, NEAR CENTER
DU-3,4	180+337.8	180+210.0	RIGHT	127.8	RIGHT EDGE OF RAMP N
DU-4	180+210.0	-	RIGHT	8.8	RAMP N, LATERAL PIPE
DU-4	180+210.0	180+081.0	RIGHT	129.0	RIGHT EDGE OF RAMP N
DU-4	3+850.3	3+924.7	LEFT	74.4	I-80, NEAR CENTER
DU-4	3+925.3	3+969.7	LEFT	44.4	I-80, NEAR CENTER
DU-4	3+986.0	4+044.7	LEFT	58.7	I-80, NEAR CENTER
DU-4,5	4+045.3	4+119.7	LEFT	74.4	I-80, NEAR CENTER
DU-5	4+120.3	4+194.7	LEFT	74.4	I-80, NEAR CENTER
DU-5	4+194.7	4+249.7	LEFT	55.0	I-80, NEAR CENTER
DU-5	4+250.3	4+324.7	LEFT	74.4	I-80, NEAR CENTER
DU-5	4+325.3	4+369.7	LEFT	44.4	I-80, NEAR CENTER
DU-5	4+390.3	4+420.7	LEFT	30.4	I-80, NEAR CENTER
DU-5,6	4+427.1	4+494.7	LEFT	67.6	I-80, NEAR CENTER
TOTAL				2877	

A ADJUSTMENT SCHEDULE

STATION	OFFSET	FRAMES AND GRATES TO BE ADJUSTED EACH
3+555.0	0.0	1
3+615.0	0.0	1
3+690.0	0.0	1
3+700.0	0.0	1
3+775.0	0.0	1
3+850.0	0.0	1
3+925.0	0.0	1
3+951.1	20.0 LT	1
3+970.0	0.0	1
4+027.0	20.6 LT	1
4+045.0	0.0	1
4+050.4	22.0 LT	1
4+090.0	21.1 LT	1
4+098.5	22.6 LT	1
4+120.0	0.0	1
4+172.5	22.6 LT	1
4+177.5	22.6 LT	1
4+194.7	0.0	1
4+245.5	22.6 LT	1
4+250.0	0.0	1
SUB TOTAL		20

ADJUSTMENT SCHEDULE CONT

STATION	OFFSET	FRAMES AND GRATES TO BE ADJUSTED EACH
4+250.5	22.6 LT	1
4+322.5	22.6 LT	1
4+325.0	0.0	1
4+327.5	22.6 LT	1
4+337.8	0.0	1
4+370.0	0.0	1
4+370.5	22.6 LT	1
4+380.0	0.0	1
4+390.0	0.0	1
4+390.5	22.6 LT	1
4+402.5	22.6 LT	1
4+421.0	0.0	1
4+426.2	0.0	1
4+465.5	22.6 LT	1
4+477.5	22.6 LT	1
4+495.0	0.0	1
TOTAL		36

DU-12

REVISIONS		ILLINOIS DEPARTMENT OF TRANSPORTATION F.A.I. ROUTE 80/94 (INTERSTATE 80/294)
NAME	DATE	
		PROPOSED DRAINAGE PIPE SCHEDULE
		DATE: JULY 18, 2005
		DRAWN BY: JWM CHECKED BY: RCH
		 McDonough Associates Inc. Engineers / Architects

EX XX

EXISTING DRAINAGE FEATURE TYPE	EXISTING DRAINAGE FEATURE NUMBER	STATION	OFFSET	REMOVING MANHOLES EACH	REMOVING CATCH BASINS EACH	REMOVING INLETS EACH	FILLING MANHOLES EACH	END SECTIONS TO BE REMOVED EACH	STORM SEWERS TO BE GROUDED CU M	STORM SEWER REMOVAL 300 mm M	STORM SEWER REMOVAL 375 mm M	REMOVE EXISTING CULVERTS EACH	CB FILL TO MAIN FLOW EACH	TRENCH BACKFILL CU M	SLOTTED DRAIN REMOVAL M	COMMENTS
STRUCTURE PIPE	01	3+027	34.1 RT					1								300mm CULVERT
STRUCTURE PIPE	02	-	-									1				
STRUCTURE PIPE	03	3+065.00	48.4 RT					1								
STRUCTURE PIPE	04	-	-								37.0			25		375mm-22m PRE-STAGE I, 15m STAGE II
STRUCTURE PIPE	05	3+115.00	0.0		1				6.0							
STRUCTURE PIPE	06	-	-													
STRUCTURE PIPE	07	3+115.00	37.5 LT		1											REMOVED BY OTHERS
STRUCTURE PIPE	08	-	-													REMOVED BY OTHERS
STRUCTURE PIPE	09	-	-													
STRUCTURE PIPE	10	3+173.00	25.8 LT	1												
STRUCTURE PIPE	11	-	-						0.9							300mm-12.2m SS TO BE GROUDED
STRUCTURE PIPE	12	3+179.00	15.0 LT	1												
STRUCTURE PIPE	13	-	-						1							300mm-14.0m SS TO BE GROUDED
STRUCTURE PIPE	14	3+177.00	0.0		1											
STRUCTURE PIPE	15	3+157.00	31.0 RT		1											
STRUCTURE PIPE	16	-	-													REMOVED BY OTHERS
STRUCTURE PIPE	17	3+253.00	0.0			1										
STRUCTURE PIPE	18	-	-						1.1							300mm-15.7m SS TO BE GROUDED
STRUCTURE PIPE	19	3+255.00	16.7 LT			1										
STRUCTURE PIPE	20	-	-						7.1		23.2			16		64.3m OF SS TO BE GROUDED, 23.2m OF SS TO BE REMOVED
STRUCTURE PIPE	21	-	-													REMOVED BY OTHERS
STRUCTURE PIPE	22	3+315.00	28.2 RT	1												
STRUCTURE PIPE	23	-	-						21.3							900mm-33.4m OF SS TO BE GROUDED
STRUCTURE PIPE	24	3+345.00	14.2 RT										1			STR TO BE FILLED TO MAINTAIN FLOW DURING STAGE IA, SEE DD-1
STRUCTURE PIPE	25	-	-						8.5							900mm-13.4m OF SS TO BE GROUDED
STRUCTURE PIPE	26	3+343.00	0.0													STR REMOVED DURING EXC OF PR SS
STRUCTURE PIPE	27	-	-						13.8							900mm-21.7m OF SS TO BE GROUDED
STRUCTURE PIPE	28	3+342.00	22.2 LT										1			STR TO BE FILLED TO MAINTAIN FLOW DURING PRE-STAGE, SEE DD-1
STRUCTURE PIPE	29	-	-						21.9							900mm-34.5m OF SS TO BE GROUDED
STRUCTURE PIPE	30	-	-								226			149		300mm
STRUCTURE PIPE	31	3+568.00	16.2 LT	1												
STRUCTURE PIPE	32	-	-						7.8							450mm-49.2m OF SS TO BE GROUDED
STRUCTURE PIPE	33	3+555.00	0.0													TO REMAIN IN PLACE
STRUCTURE PIPE	34	-	-													TO REMAIN IN PLACE
STRUCTURE PIPE	35	3+615.00	0.0													TO REMAIN IN PLACE
STRUCTURE PIPE	36	-	-						0.8							450mm-5.3m OF SS TO BE GROUDED
STRUCTURE PIPE	37	3+620.00	2.2 RT				1									MANHOLE TO BE FILLED IN STAGE II
STRUCTURE PIPE	38	-	-						17.2							61m OF SS TO BE GROUDED
STRUCTURE PIPE	39	3+679.00	15.8 LT											1		STR TO BE FILLED TO MAINTAIN FLOW DURING STAGE IA, SEE DD-1
STRUCTURE PIPE	40	-	-													SS TO BE FILLED BY OTHERS
SLOT DRAIN	41	-	-												134.4	
SLOT DRAIN	42	-	-												24.4	
SLOT DRAIN	43	-	-												44.3	
SLOT DRAIN	44	-	-												9.6	
SLOT DRAIN	45	-	-												9.6	
SLOT DRAIN	46	-	-												9.6	
SLOT DRAIN	47	-	-												9.5	
SLOT DRAIN	48	-	-												9.6	
SLOT DRAIN	49	-	-												9.4	
SLOT DRAIN	50	-	-												9.6	
SLOT DRAIN	51	-	-												9.6	
SLOT DRAIN	52	-	-												9.6	
SLOT DRAIN	53	-	-												9.6	
SLOT DRAIN	54	-	-												9.6	
SLOT DRAIN	55	-	-												9.4	
SLOT DRAIN	56	-	-												9.4	
SLOT DRAIN	57	-	-												9.5	
SLOT DRAIN	58	-	-												9.5	
			TOTAL	4	4	2	1	2	107.4	226	60	1	3	190	346.2	

UNLESS OTHERWISE NOTED ALL EXISTING STRUCTURES TO REMAIN IN PLACE

DU-13

REVISIONS		ILLINOIS DEPARTMENT OF TRANSPORTATION F.A.I. ROUTE 80/94 (INTERSTATE 80/294)
NAME	DATE	
		PROPOSED DRAINAGE REMOVAL SCHEDULE
		DATE: JULY 18, 2005
		DRAWN BY: JWM CHECKED BY: RCH
		McDonough Associates Inc. Engineers / Architects

F.A.I. RTE. 80/94	SECTION *	COUNTY COOK	TOTAL SHEETS 231	SHEET NO. 89
STA. FED. ROAD DIST. NO. 1		TO STA. ILLINOIS FED. AID PROJECT		
*(0203.1 & 0304) R-6		CONTRACT # 62105		

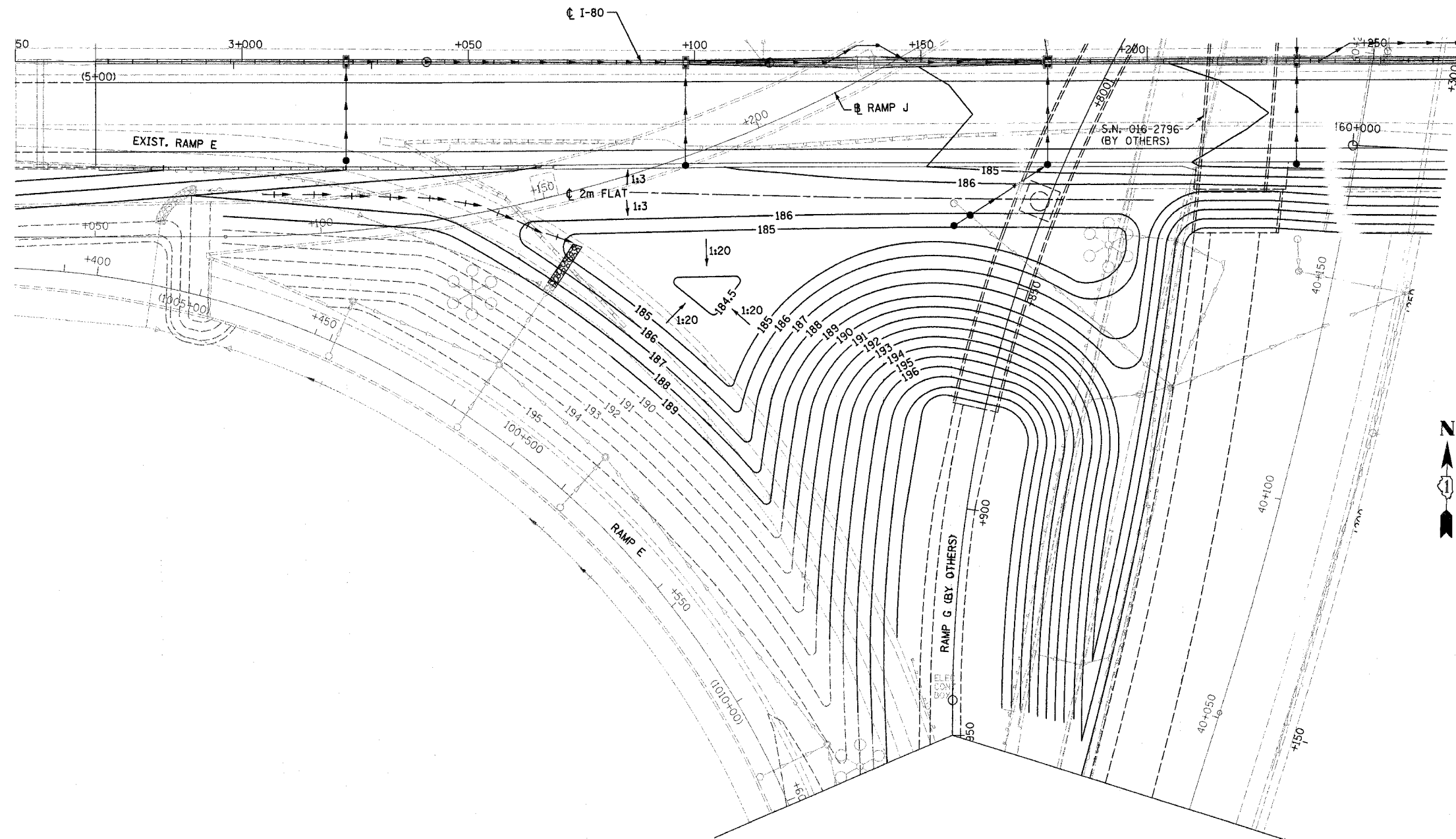

IG-1

REVISIONS		ILLINOIS DEPARTMENT OF TRANSPORTATION F.A.I. ROUTE 80/94 (INTERSTATE 80/294)
NAME	DATE	
DATE: JULY 18, 2005		DRAWN BY: JWM CHECKED BY: RCH
 McDonough Associates Inc. Engineers / Architects		



F.A. RTE.	SECTION	COUNTY	TOTAL SHEETS	SHEET NO.
80/94	SEE BELOW	COOK	231	90
STA.		TO STA.		
FED. ROAD DIST. NO.	ILLINOIS	FED. AID PROJECT		
* (0203.1 & 0304) R-6		CONTRACT # 62105		

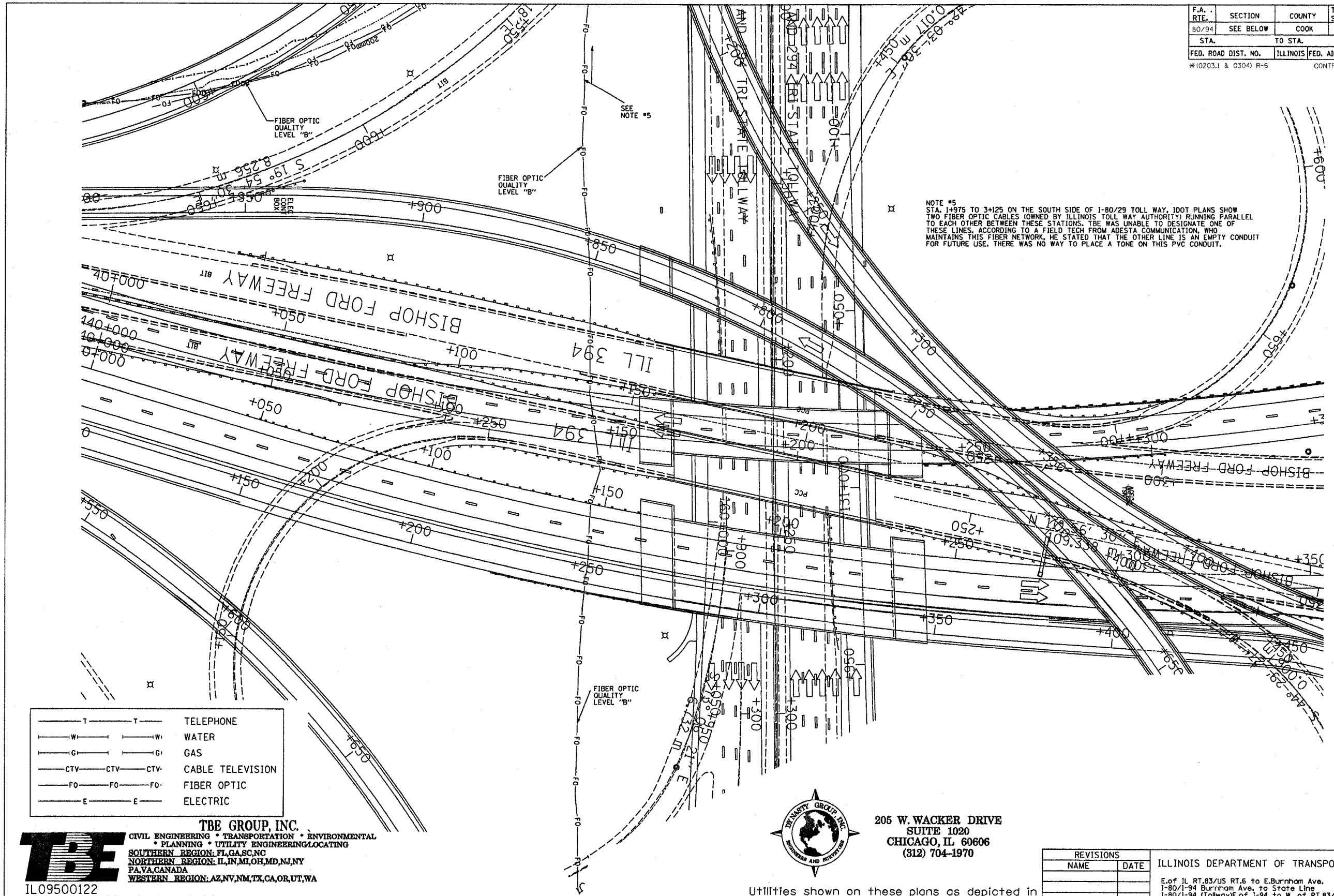

NOTE #5
 STA. 1+975 TO 3+125 ON THE SOUTH SIDE OF I-80/29 TOLL WAY, IDOT PLANS SHOW TWO FIBER OPTIC CABLES (OWNED BY ILLINOIS TOLL WAY AUTHORITY) RUNNING PARALLEL TO EACH OTHER BETWEEN THESE STATIONS. TBE WAS UNABLE TO DESIGNATE ONE OF THESE LINES, ACCORDING TO A FIELD TECH FROM ADESTA COMMUNICATION, WHO MAINTAINS THIS FIBER NETWORK, HE STATED THAT THE OTHER LINE IS AN EMPTY CONDUIT FOR FUTURE USE. THERE WAS NO WAY TO PLACE A TONE ON THIS PVC CONDUIT.

— T — T —	TELEPHONE
— W — W —	WATER
— G — G —	GAS
— CTV — CTV — CTV —	CABLE TELEVISION
— FO — FO — FO —	FIBER OPTIC
— E — E —	ELECTRIC

TBE GROUP, INC.
 CIVIL ENGINEERING * TRANSPORTATION * ENVIRONMENTAL
 * PLANNING * UTILITY ENGINEERING/LOCATING
 SOUTHERN REGION: FL, GA, SC, NC
 NORTHERN REGION: IL, IN, MI, OH, MD, NJ, NY
 PA, VA, CANADA
 WESTERN REGION: AZ, NV, NM, TX, CA, OR, UT, WA

IL09500122
 TBE SUE PAGE NO: 14 of 52
 Signature *Robert L. James Jr.*
 SUE Quality Level "A" : Test Holes
 SUE Quality Level "B" : Designating



205 W. WACKER DRIVE
 SUITE 1020
 CHICAGO, IL 60606
 (312) 704-1970

SU-1

Utilities shown on these plans as depicted in the legend have been investigated by TBE Group, Inc in accordance with SUE Industry Standards as of 2/8/02.
 All other information shown has been provided to TBE Group, Inc by others.

REVISIONS		ILLINOIS DEPARTMENT OF TRANSPORTATION
NAME	DATE	
		E. of IL RT. 83/US RT. 6 to E. Burnham Ave.
		1-80/I-94 Burnham Ave. to State Line
		1-80/I-94 (Tollway) E. of I-94 to W. of RT. 83/US 6.
		1-94/IL RT. 394 S. of US 6 to 186th Street (N. bound & S. bound)
		Contract No. 62110, 62111, 62114, 62105, 62107, 62108
		SCALE : 500 DRAWN BY : JAC
		SQL "B" DATE : 2/8/02 CHECKED BY

F.A. RTE.	SECTION	COUNTY	TOTAL SHEETS	SHEET NO.
80/94	SEE BELOW	COOK	231	91
STA.	TO STA.			
FED. ROAD DIST. NO.	ILLINOIS	FED. AID PROJECT		
*(0203.1 & 0304) R-6		CONTRACT # 62105		

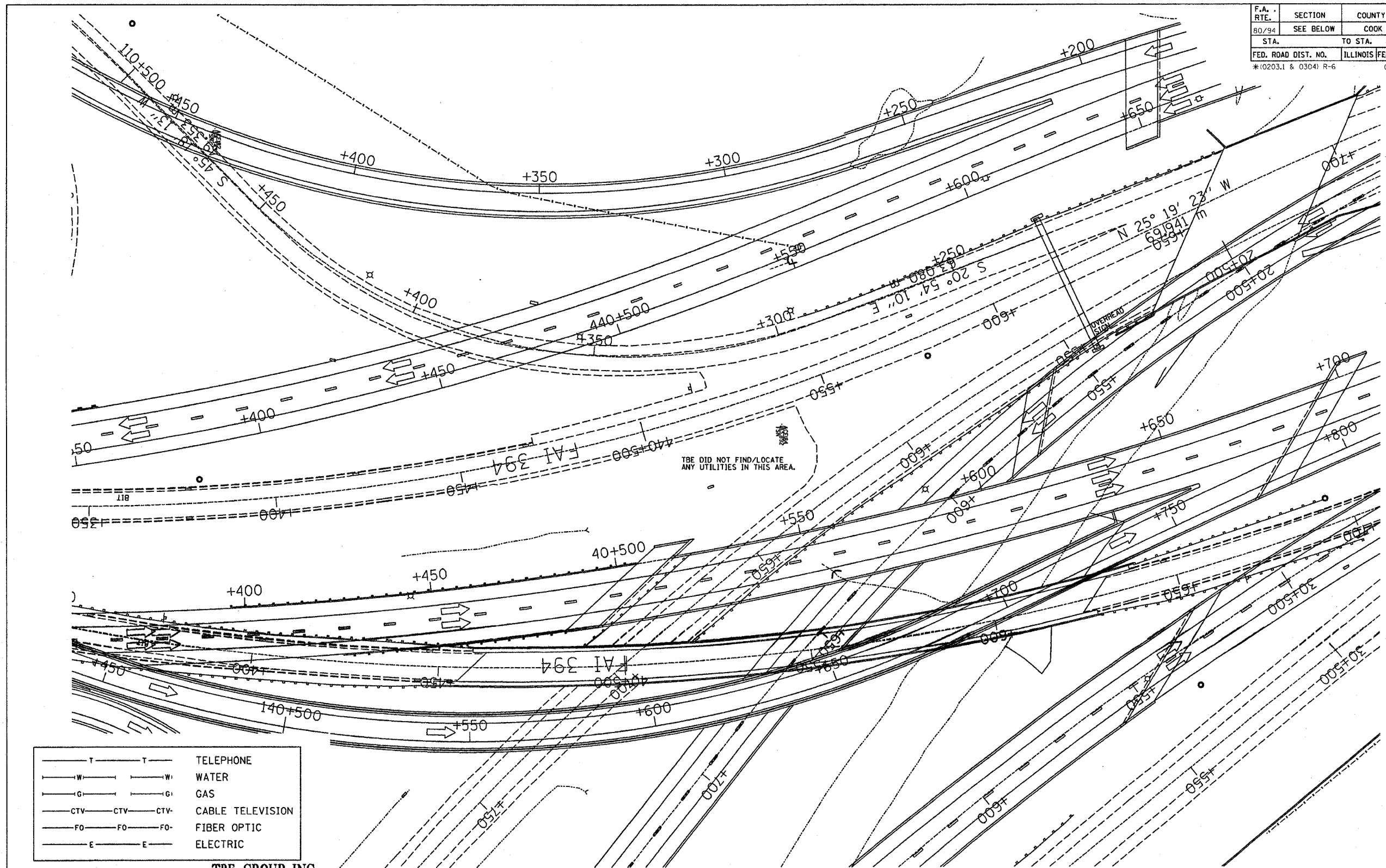

— T — T —	TELEPHONE
— W — W —	WATER
— G — G —	GAS
— CTV — CTV —	CABLE TELEVISION
— FO — FO —	FIBER OPTIC
— E — E —	ELECTRIC

TBE GROUP, INC.
 CIVIL ENGINEERING * TRANSPORTATION * ENVIRONMENTAL
 * PLANNING * UTILITY ENGINEERING/LOCATING
 SOUTHERN REGION: FL, GA, SC, NC
 NORTHERN REGION: IL, IN, MI, OH, MD, NJ, NY
 PA, VA, CANADA
 WESTERN REGION: AZ, NV, NM, TX, CA, OR, UT, WA

IL09500122
 TBE SUE PAGE, NO: 15 of 52
 Signature *Robert J. Demers, Jr.*
 SUE Quality Level "A" : Test Holes
 SUE Quality Level "B" : Designating



205 W. WACKER DRIVE
 SUITE 1020
 CHICAGO, IL 60606
 (312) 704-1970

Utilities shown on these plans as depicted in the legend have been investigated by TBE Group, Inc in accordance with SUE Industry Standards as of 2/8/02.
 All other information shown has been provided to TBE Group, Inc by others.

REVISIONS		ILLINOIS DEPARTMENT OF TRANSPORTATION
NAME	DATE	
		E. of IL RT. 83/US RT. 6 to E. Burnham Ave. I-80/I-94 Burnham Ave. to State Line I-80/I-94 (Tollway) E. of I-94 to W. of RT. 83/US 6. I-94/IL RT. 394 S. of US 6 to 186th Street (N. bound & S. bound) Contract No. 62110, 62111, 62114, 62105, 62107, 62108 SCALE : 500 DRAWN BY : JAC SOL "B" DATE : 2/8/02 CHECKED BY :

SU-2

F.A. RTE.	SECTION	COUNTY	TOTAL SHEETS	SHEET NO.
80/94	SEE BELOW	COOK	231	92
STA. TO STA.				
FED. ROAD DIST. NO.			ILLINOIS FED. AID PROJECT	
*10203.1 & 03041 R-6			CONTRACT # 62105	

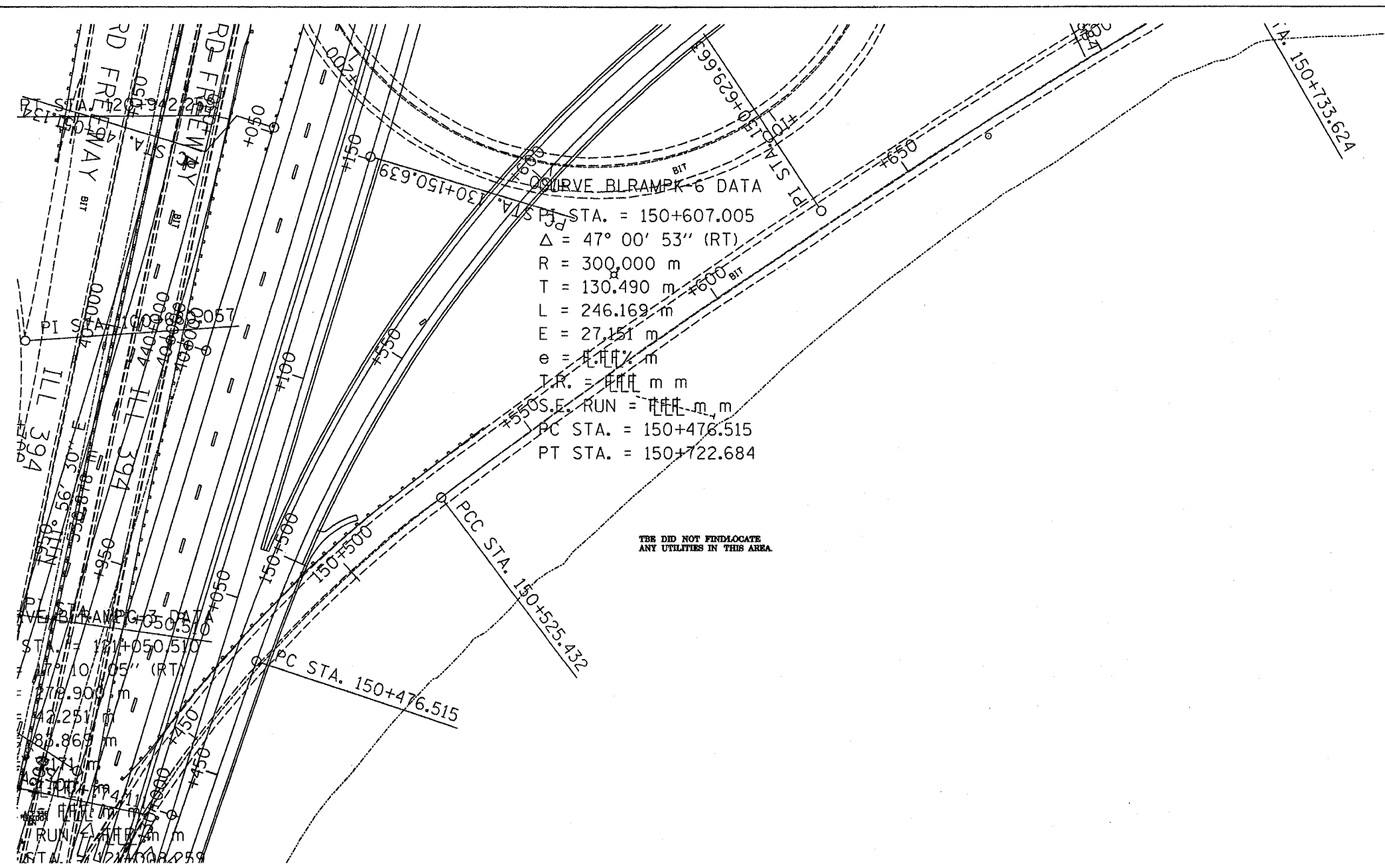

— T — T —	TELEPHONE
— W — W —	WATER
— G — G —	GAS
— CTV — CTV —	CABLE TELEVISION
— FO — FO —	FIBER OPTIC
— E — E —	ELECTRIC

TBE GROUP, INC.
 CIVIL ENGINEERING • TRANSPORTATION • ENVIRONMENTAL
 • PLANNING • UTILITY ENGINEERING/LOCATING
 SOUTHERN REGION: FL, GA, SC, NC
 NORTHERN REGION: IL, IN, MI, OH, MD, NJ, NY
 P.A., VA, CANADA
 WESTERN REGION: AZ, NV, NM, TX, CA, OR, UT, WA

IL09500122
 TBE SUE PAGE NO: 47 of 52
 Signature *[Handwritten Signature]*
 SUE Quality Level "A" : Test Holes
 SUE Quality Level "B" : Designating



205 W. WACKER DRIVE
 SUITE 1020
 CHICAGO, IL 60606
 (312) 704-1970

Utilities shown on these plans as depicted in the legend have been investigated by TBE Group, Inc in accordance with SUE Industry Standards as of 2/8/02.
 All other information shown has been provided to TBE Group, Inc by others.

REVISIONS		ILLINOIS DEPARTMENT OF TRANSPORTATION
NAME	DATE	
		E. of IL RT. 83/US RT. 6 to E. Burnham Ave. I-80/I-94 Burnham Ave. to State Line I-80/I-94 (Tollway) E. of I-94 to W. of RT. 83/US 6. I-94/IL RT. 394 S. of US 6 to 186th Street (N. bound & S. bound) Contract No. 62110, 62111, 62114, 62105, 62107, 62108 SCALE: 500 DRAWN BY: JAC SOL "B" DATE: 2/8/02 CHECKED BY:

SU-3

F.A. RTE.	SECTION	COUNTY	TOTAL SHEETS	SHEET NO.
80/94	SEE BELOW	COOK	231	93
STA.		TO STA.		
FED. ROAD DIST. NO.	ILLINOIS FED. AID PROJECT			
*10203.1 & 0304 R-6	CONTRACT # 62105			

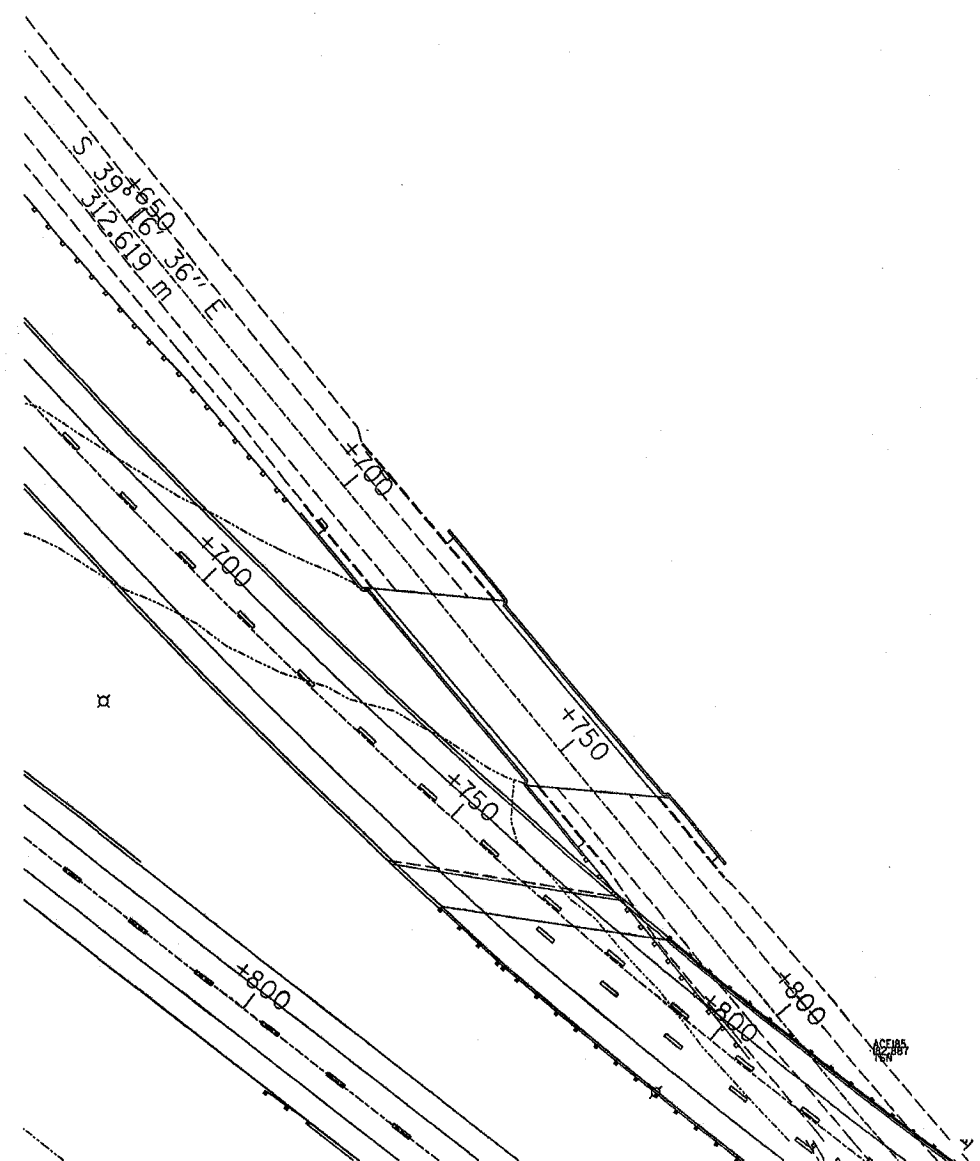

TBE DID NOT FIND/LOCATE ANY UTILITIES IN THIS AREA.

M

— T — T —	TELEPHONE
— W — W —	WATER
— G — G —	GAS
— CTV — CTV — CTV —	CABLE TELEVISION
— FO — FO — FO —	FIBER OPTIC
— E — E —	ELECTRIC

TBE GROUP, INC.
 CIVIL ENGINEERING * TRANSPORTATION * ENVIRONMENTAL
 * PLANNING * UTILITY ENGINEERING/LOCATING
 SOUTHERN REGION: FL, GA, SC, NC
 NORTHERN REGION: IL, IN, MI, OH, MD, NJ, NY
 PA, VA, CANADA
 WESTERN REGION: AZ, NV, NM, TX, CA, OR, UT, WA

IL09500122
 TBE SUE PAGE NO: 48 of 52
 Signature *Robert A. Clemens Jr.*
 SUE Quality Level "A" : Test Holes
 SUE Quality Level "B" : Designating



205 W. WACKER DRIVE
 SUITE 1020
 CHICAGO, IL 60606
 (312) 704-1970

Utilities shown on these plans as depicted in the legend have been investigated by TBE Group, Inc in accordance with SUE Industry Standards as of 2/8/02.
 All other information shown has been provided to TBE Group, Inc by others.

REVISIONS	
NAME	DATE

ILLINOIS DEPARTMENT OF TRANSPORTATION
 E. of IL RT. 83/US RT. 6 to E. Burnham Ave.
 I-80/I-94 Burnham Ave. to State Line
 I-80/I-94 (Tollway) E. of I-94 to W. of RT. 83/US 6.
 I-94/I-11 RT. 394 S. of US 6 to 186th Street (Inbound & S. bound)
 Contract No. 62110, 62111, 62114, 62105, 62107, 62108
 SCALE : 500 DRAWN BY : JAC
 SOL "B" DATE : 2/8/02 CHECKED BY

SU-4

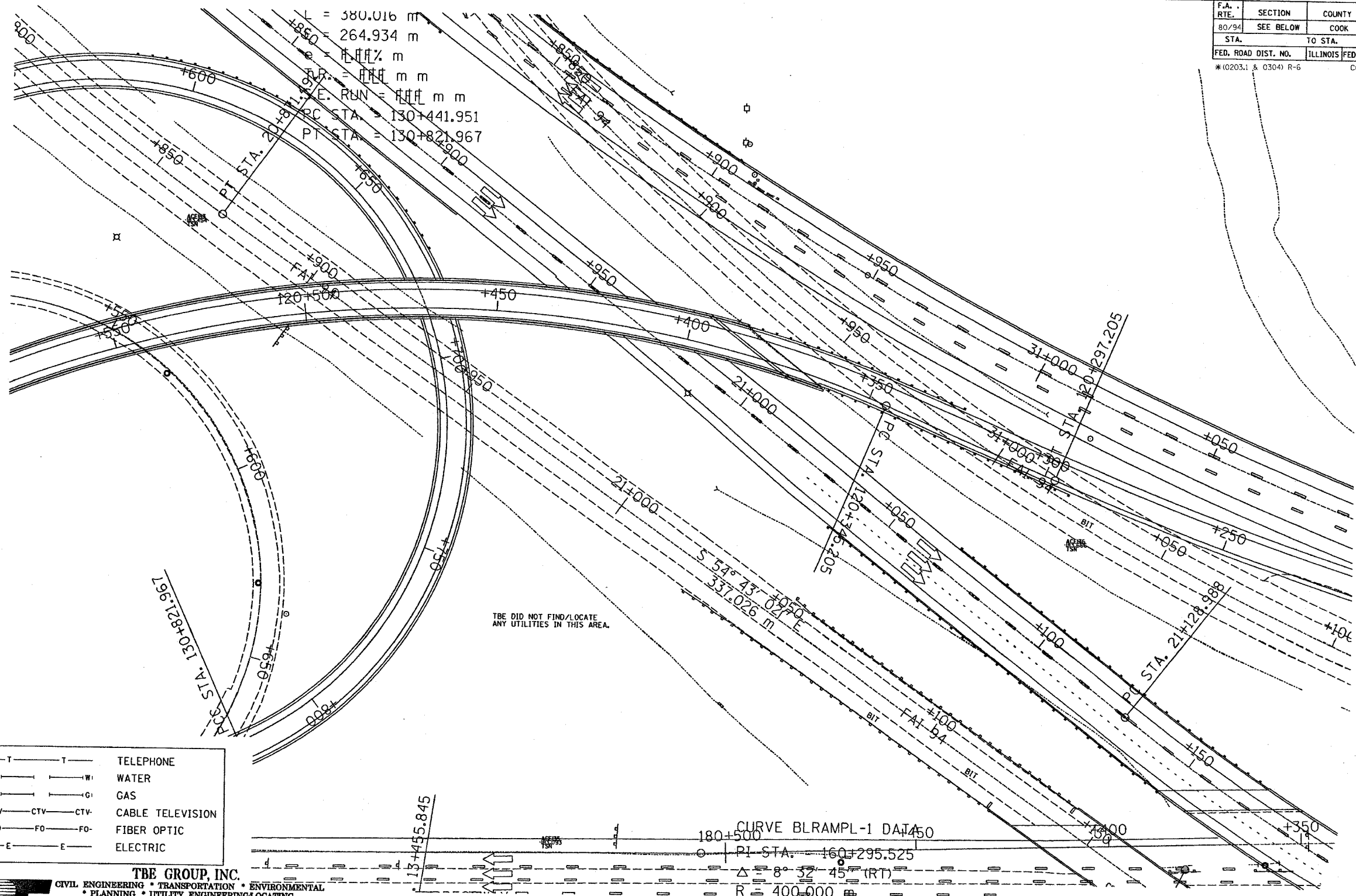

F.A. RTE.	SECTION	COUNTY	TOTAL SHEETS	SHEET NO.
80/94	SEE BELOW	COOK	231	94
STA.		TO STA.		
FED. ROAD DIST. NO.		ILLINOIS FED. AID PROJECT		
*(0203.1 & 0304) R-6		CONTRACT # 62105		

$L = 380.016 \text{ m}$
 $e = 264.934 \text{ m}$
 $\text{SUE RUN} = \text{m m}$
 $\text{PC STA} = 130+441.951$
 $\text{PT STA} = 130+821.967$

TBE DID NOT FIND/LOCATE ANY UTILITIES IN THIS AREA.

— T — T —	TELEPHONE
— W — W —	WATER
— G — G —	GAS
— CTV — CTV — CTV —	CABLE TELEVISION
— FO — FO — FO —	FIBER OPTIC
— E — E —	ELECTRIC

TBE GROUP, INC.
 CIVIL ENGINEERING * TRANSPORTATION * ENVIRONMENTAL
 * PLANNING * UTILITY ENGINEERING/LOCATING
 SOUTHERN REGION: FL, GA, SC, NC
 NORTHERN REGION: IL, IN, MI, OH, MD, NJ, NY
 PA, VA, CANADA
 WESTERN REGION: AZ, NV, NM, TX, CA, OR, UT, WA

IL09500122
 TBE SUE PAGE NO: 49 of 52
 Signature *Robert A. Clemens Jr.*
 SUE Quality Level "A" : Test Holes
 SUE Quality Level "B" : Designating



205 W. WACKER DRIVE
 SUITE 1020
 CHICAGO, IL 60606
 (312) 704-1970

CURVE BLRAMPL-1 DATA
 $\text{PI STA} = 160+295.525$
 $\Delta = 8^\circ 57' 45'' \text{ (RT)}$
 $R = 400.000 \text{ ft}$

Utilities shown on these plans as depicted in the legend have been investigated by TBE Group, Inc in accordance with SUE Industry Standards as of 2/8/02. All other information shown has been provided to TBE Group, Inc by others.

REVISIONS	
NAME	DATE

ILLINOIS DEPARTMENT OF TRANSPORTATION
 E. of IL RT. 83/US RT. 6 to E. Burnham Ave.
 I-80/I-94 Burnham Ave. to State Line
 I-80/I-94 (Tollway) E. of I-94 to W. of RT. 83/US 6.
 I-94/IL RT. 394 S. of US 6 to 186th Street (N. bound & S. bound)
 Contract No. 62110, 62111, 62114, 62105, 62107, 62108
 SCALE : 500 DRAWN BY : JAC
 SOL "B" DATE : 2/8/02 CHECKED BY

SU-5

F.A. RTE. 80/94	SECTION SEE BELOW	COUNTY COOK	TOTAL SHEETS 231	SHEET NO. 95
STA.	TO STA.			
FED. ROAD DIST. NO.	ILLINOIS	FED. AID PROJECT		
*0203.1 & 0304 R-6		CONTRACT # 62105		

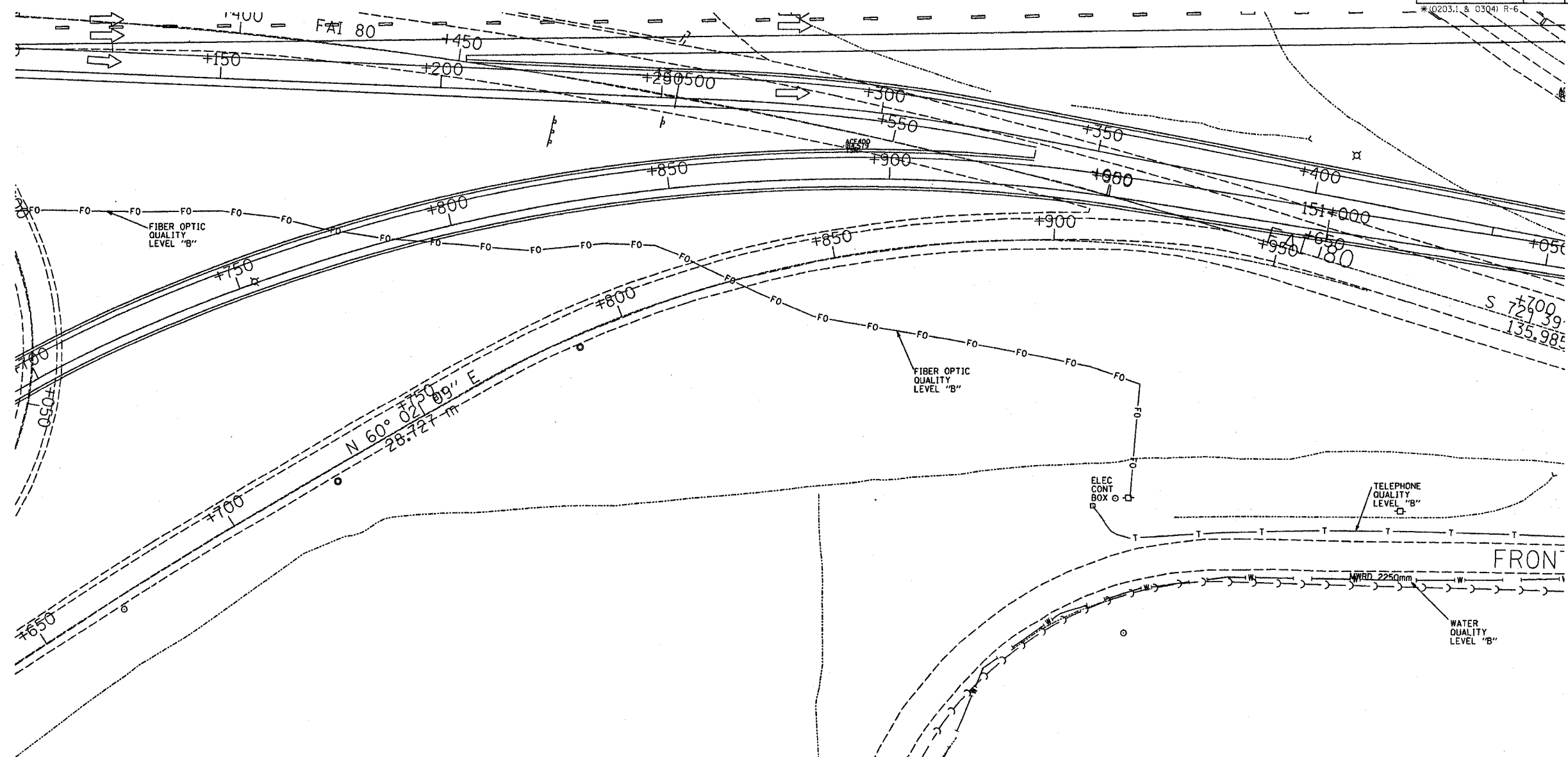

— T — T —	TELEPHONE
— W — W —	WATER
— G — G —	GAS
— CTV — CTV — CTV —	CABLE TELEVISION
— FO — FO — FO —	FIBER OPTIC
— E — E —	ELECTRIC

TBE GROUP, INC.
 CIVIL ENGINEERING • TRANSPORTATION • ENVIRONMENTAL
 • PLANNING • UTILITY ENGINEERING/LOCATING
 SOUTHERN REGION: FL, GA, SC, NC
 NORTHERN REGION: IL, IN, MI, OH, MD, NJ, NY
 PA, VA, CANADA
 WESTERN REGION: AZ, NV, NM, TX, CA, OR, UT, WA

ILO9500122
 TBE SUE PAGE NO: 24 of 52
 Signature *Robert D. Clemens Jr.*
 SUE Quality Level "A" : Test Holes
 SUE Quality Level "B" : Designating



205 W. WACKER DRIVE
 SUITE 1020
 CHICAGO, IL 60606
 (312) 704-1970

Utilities shown on these plans as depicted in the legend have been investigated by TBE Group, Inc in accordance with SUE Industry Standards as of 2/8/02. All other information shown has been provided to TBE Group, Inc by others.

SU-6

REVISIONS		ILLINOIS DEPARTMENT OF TRANSPORTATION
NAME	DATE	
		E. of IL RT. 83/US RT. 6 to E. Burnham Ave. I-80/I-94 Burnham Ave. to State Line I-80/I-94 (Tollway) E. of I-94 to W. of RT. 83/US 6. I-94/IL RT. 394 S. of US 6 to 186th Street (N. bound & S. bound) Contract No. 62110, 62111, 62114, 62105, 62107, 62108 SCALE : 500 DRAWN BY : JAC SQL "B" DATE : 2/8/02 CHECKED BY :

F.A. RTE.	SECTION	COUNTY	TOTAL SHEETS	SHEET NO.
80/94	SEE BELOW	COOK	231	96
STA.		TO STA.		
FED. ROAD DIST. NO.		ILLINOIS	FED. AID PROJECT	
*(0203.1 & 0304) R-6		CONTRACT # 62105		

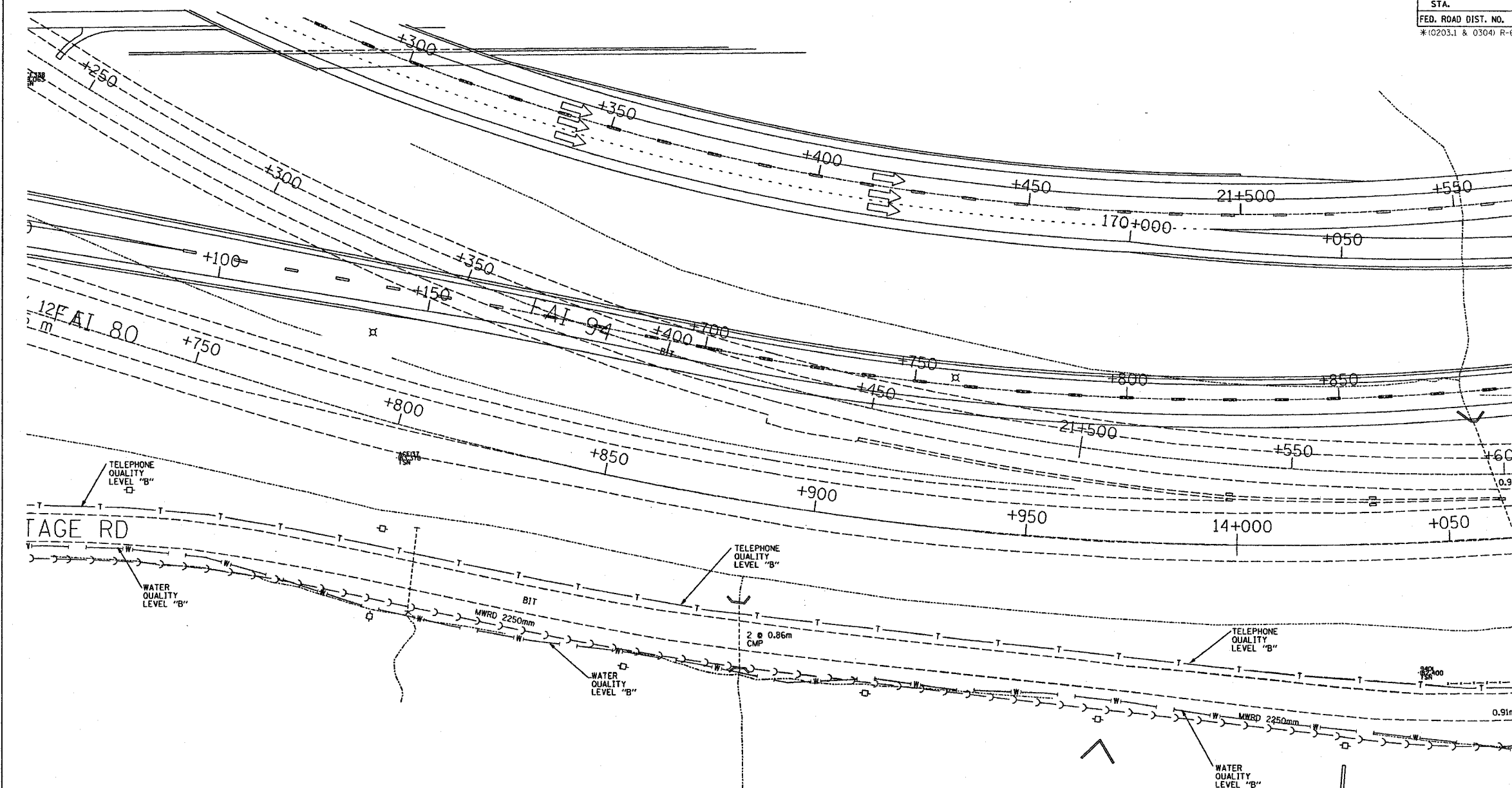

— T — T —	TELEPHONE
— W — W —	WATER
— G — G —	GAS
— CTV — CTV — CTV —	CABLE TELEVISION
— FO — FO — FO —	FIBER OPTIC
— E — E —	ELECTRIC

TBE GROUP, INC.
 CIVIL ENGINEERING * TRANSPORTATION * ENVIRONMENTAL
 * PLANNING * UTILITY ENGINEERING/LOCATING
 SOUTHERN REGION: FL, GA, SC, NC
 NORTHERN REGION: IL, IN, MI, OH, MD, NJ, NY
 PA, VA, CANADA
 WESTERN REGION: AZ, NV, NM, TX, CA, OR, UT, WA

IL09500122
 TBE SUE PAGE NO: 25 of 52
 Signature *Robert J. Clemens Jr.*
 SUE Quality Level "A" : Test Holes
 SUE Quality Level "B" : Designating



205 W. WACKER DRIVE
 SUITE 1020
 CHICAGO, IL 60606
 (312) 704-1970

Utilities shown on these plans as depicted in the legend have been investigated by TBE Group, Inc in accordance with SUE Industry Standards as of 2/8/02.
 All other information shown has been provided to TBE Group, Inc by others.

REVISIONS	
NAME	DATE

ILLINOIS DEPARTMENT OF TRANSPORTATION

E. of IL RT. 83/US RT. 6 to E. Burnham Ave.
 I-80/I-94 Burnham Ave. to State Line
 I-80/I-94 (Tollway) E. of I-94 to W. of RT. 83/US 6.
 I-94/IL RT. 394 S. of US 6 to 186th Street (N. bound & S. bound)

Contract No. 62110, 62111, 62114, 62105, 62107, 62108
 SCALE : 500 DRAWN BY : JAC
 SOL "B" DATE : 2/8/02 CHECKED BY :

SU-7

F.A. RTE.	SECTION	COUNTY	TOTAL SHEETS	SHEET NO.
80/94	SEE BELOW	COOK	231	97
STA.		TO STA.		
FED. ROAD DIST. NO.	ILLINOIS FED. AID PROJECT		CONTRACT # 62105	

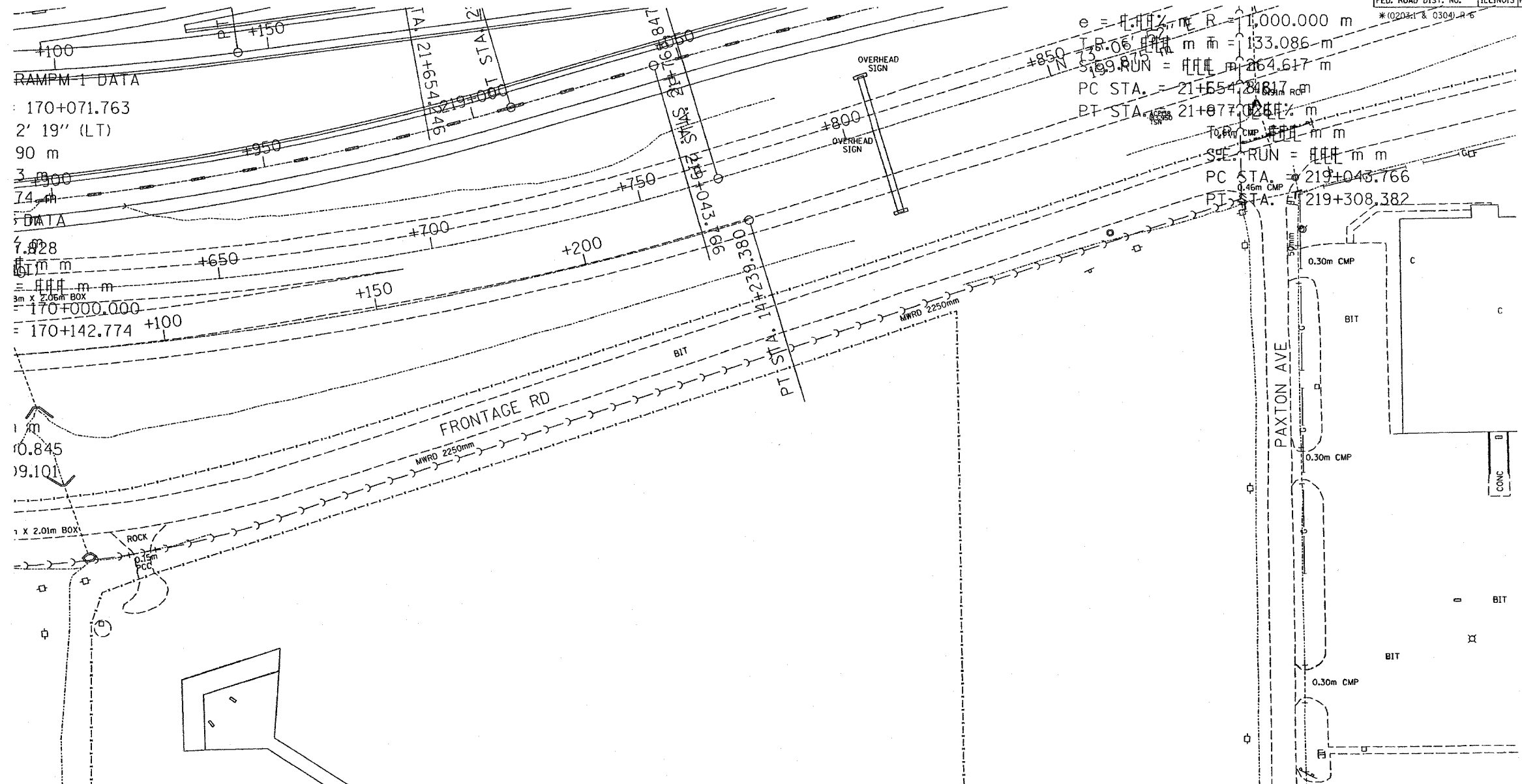

RAMP 1 DATA
 170+071.763
 2' 19" (LT)
 90 m
 3 #800
 74 m
 DATA
 7.828
 101 m
 3m x 2.06m BOX
 170+000.000
 170+142.774 +100

T	T	TELEPHONE
W	W	WATER
G	G	GAS
CTV	CTV	CABLE TELEVISION
FO	FO	FIBER OPTIC
E	E	ELECTRIC

TBE GROUP, INC.
 CIVIL ENGINEERING * TRANSPORTATION * ENVIRONMENTAL
 * PLANNING * UTILITY ENGINEERING/LOCATING
 SOUTHERN REGION: FL, GA, SC, NC
 NORTHERN REGION: IL, IN, MI, OH, MD, NJ, NY
 PA, VA, CANADA
 WESTERN REGION: AZ, NV, NM, TX, CA, OR, UT, WA

IL09500122
 TBE SUE PAGE NO: 26 of 52
 Signature *David A. Clemens Jr.*
 SUE Quality Level "A" : Test Holes
 SUE Quality Level "B" : Designating



205 W. WACKER DRIVE
 SUITE 1020
 CHICAGO, IL 60606
 (312) 704-1970

Utilities shown on these plans as depicted in the legend have been investigated by TBE Group, Inc in accordance with SUE Industry Standards as of 2/8/02.
 All other information shown has been provided to TBE Group, Inc by others.

REVISIONS		ILLINOIS DEPARTMENT OF TRANSPORTATION
NAME	DATE	
		E. of IL RT. 83/US RT. 6 to E. Burnham Ave.
		I-80/I-94 Burrham Ave. to State Line
		I-80/I-94 (Tollway) E. of I-94 to W. of RT. 83/US 6.
		I-94/IL RT. 394 S. of US 6 to 186th Street (N. bound & S. bound)
		Contract No. 62110, 62111, 62114, 62105, 62107, 62108
		SCALE : 500 DRAWN BY : JAC
		SOL "B" DATE : 2/8/02 CHECKED BY

SU-8

F.A. RTE.	SECTION	COUNTY	TOTAL SHEETS	SHEET NO.
80/94	SEE BELOW	COOK	231	98
STA.		TO STA.		
FED. ROAD DIST. NO.		ILLINOIS FED. AID PROJECT		
*(0203.1 & 0304) R-6		CONTRACT # 62105		

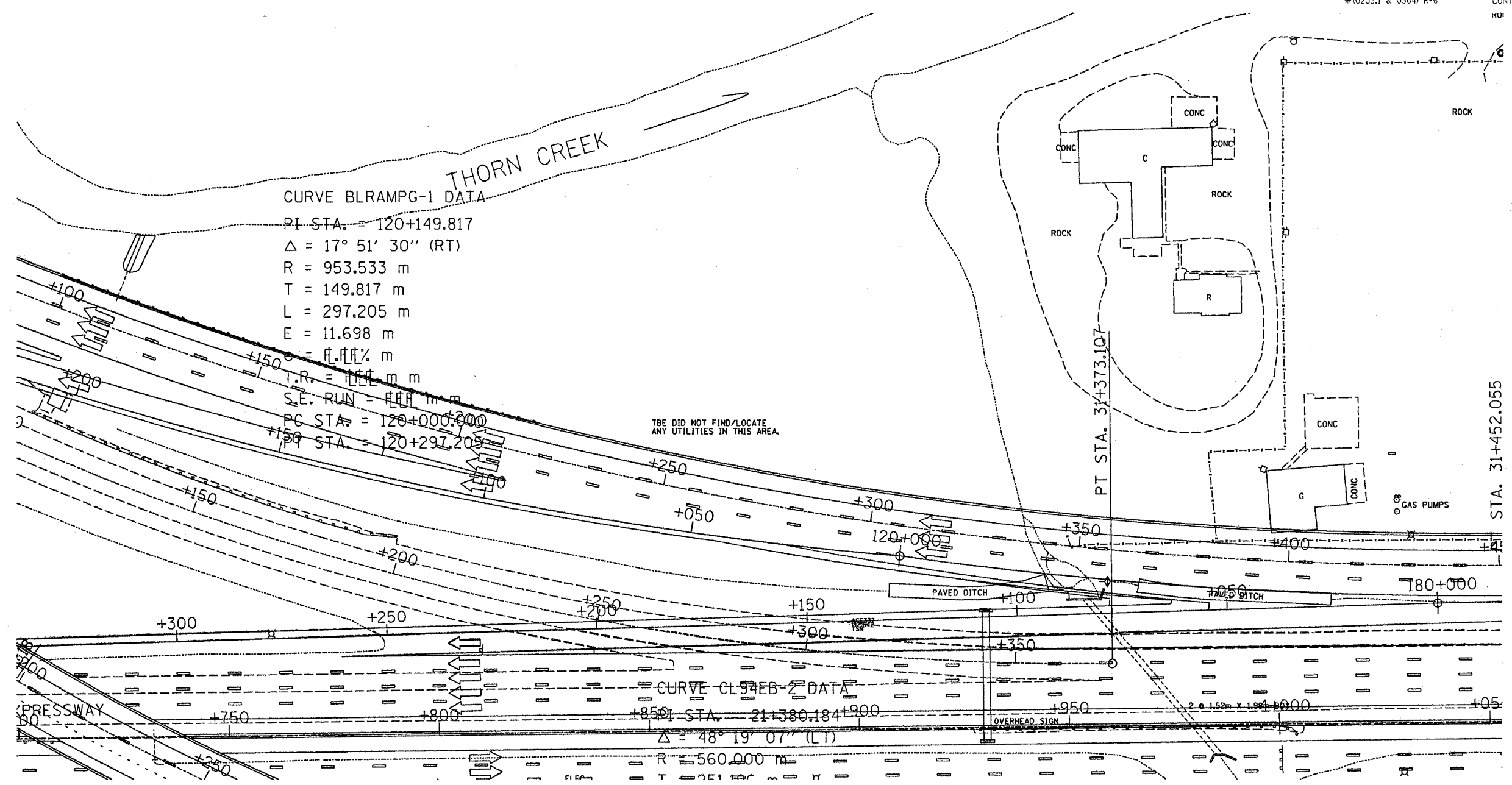

TBE GROUP, INC.
 CIVIL ENGINEERING * TRANSPORTATION * ENVIRONMENTAL
 * PLANNING * UTILITY ENGINEERING/LOCATING
 SOUTHERN REGION: FL, GA, SC, NC
 NORTHERN REGION: IL, IN, MI, OH, MD, NJ, NY
 PA, VA, CANADA
 WESTERN REGION: AZ, NV, NM, TX, CA, OR, UT, WA

IL09500122
 TBE SUE PAGE NO: 50 of 52
 Signature *Robert J. Demers Jr.*
 SUE Quality Level "A" : Test Holes
 SUE Quality Level "B" : Designating



205 W. WACKER DRIVE
 SUITE 1020
 CHICAGO, IL 60606
 (312) 704-1970

Utilities shown on these plans as depicted in the legend have been investigated by TBE Group, Inc in accordance with SUE Industry Standards as of 2/8/02. All other information shown has been provided to TBE Group, Inc by others.

REVISIONS		ILLINOIS DEPARTMENT OF TRANSPORTATION
NAME	DATE	
		E. of IL RT. 83/US RT. 6 to E. Burnham Ave.
		I-80/I-94 Burnham Ave. to State Line
		I-80/I-94 (Tollway) E. of I-94 to W. of RT. 83/US 6.
		I-94/IL RT. 394 S. of US 6 to 186th Street (N. bound & S. bound)
		Contract No. 62110, 62111, 62114, 62105, 62107, 62108
		SCALE : 500 DRAWN BY : JAC
		SOL "B" DATE : 2/8/02 CHECKED BY :

SU-9

F.A. RTE.	SECTION	COUNTY	TOTAL SHEETS	SHEET NO.
80/94	SEE BELOW	COOK	231	99
STA.	TO STA.			
FED. ROAD DIST. NO.	ILLINOIS	FED. AID PROJECT		
*0203.1 & 0304) R-6			CONTRACT # 62105	

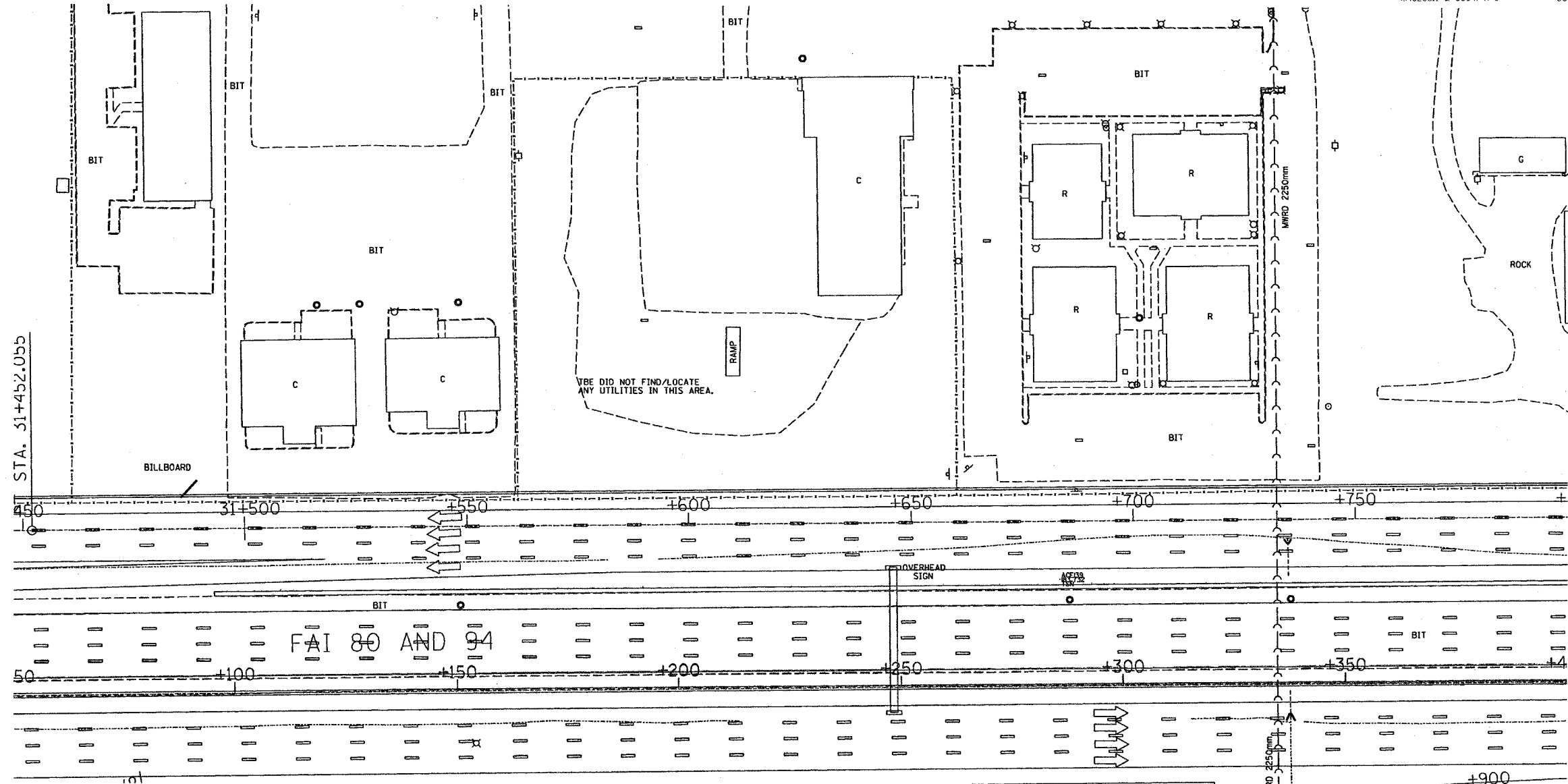

— T — T —	TELEPHONE
— W — W —	WATER
— G — G —	GAS
— CTV — CTV — CTV —	CABLE TELEVISION
— FO — FO — FO —	FIBER OPTIC
— E — E —	ELECTRIC

TBE GROUP, INC.
 CIVIL ENGINEERING • TRANSPORTATION • ENVIRONMENTAL
 • PLANNING • UTILITY ENGINEERING/LOCATING
 SOUTHERN REGION: FL, GA, SC, NC
 NORTHERN REGION: IL, IN, MI, OH, MD, NJ, NY
 PA, VA, CANADA
 WESTERN REGION: AZ, NV, NM, TX, CA, OR, UT, WA

IL09500122
 TBE SUE PAGE NO: 51 of 52
 Signature *[Signature]*
 SUE Quality Level "A": Test Holes
 SUE Quality Level "B": Designating



205 W. WACKER DRIVE
 SUITE 1020
 CHICAGO, IL 60606
 (312) 704-1970

Utilities shown on these plans as depicted in the legend have been investigated by TBE Group, Inc in accordance with SUE Industry Standards as of 2/8/02.
 All other information shown has been provided to TBE Group, Inc by others.

REVISIONS	
NAME	DATE

ILLINOIS DEPARTMENT OF TRANSPORTATION
 E. of IL RT. 83/US RT. 6 to E. Burnham Ave.
 I-80/I-94 Burnham Ave. to State Line
 I-80/I-94 Tollway E. of I-94 to W. of RT. 83/US 6.
 I-94/IL RT. 394 S. of US 6 to 186th Street N. bound & S. bound

Contract No. 62110, 62111, 62114, 62105, 62107, 62108
 SCALE: 500 DRAWN BY: JAC
 SQL "B" DATE: 2/8/02 CHECKED BY:

SU-10

F.A. RTE.	SECTION	COUNTY	TOTAL SHEETS	SHEET NO.
80/94	SEE BELOW	COOK	231	100
STA.	TO STA.			
FED. ROAD DIST. NO.	ILLINOIS	FED. AID PROJECT		
* (0203) & 03Q4 R-6 CONTRACT * 62105				

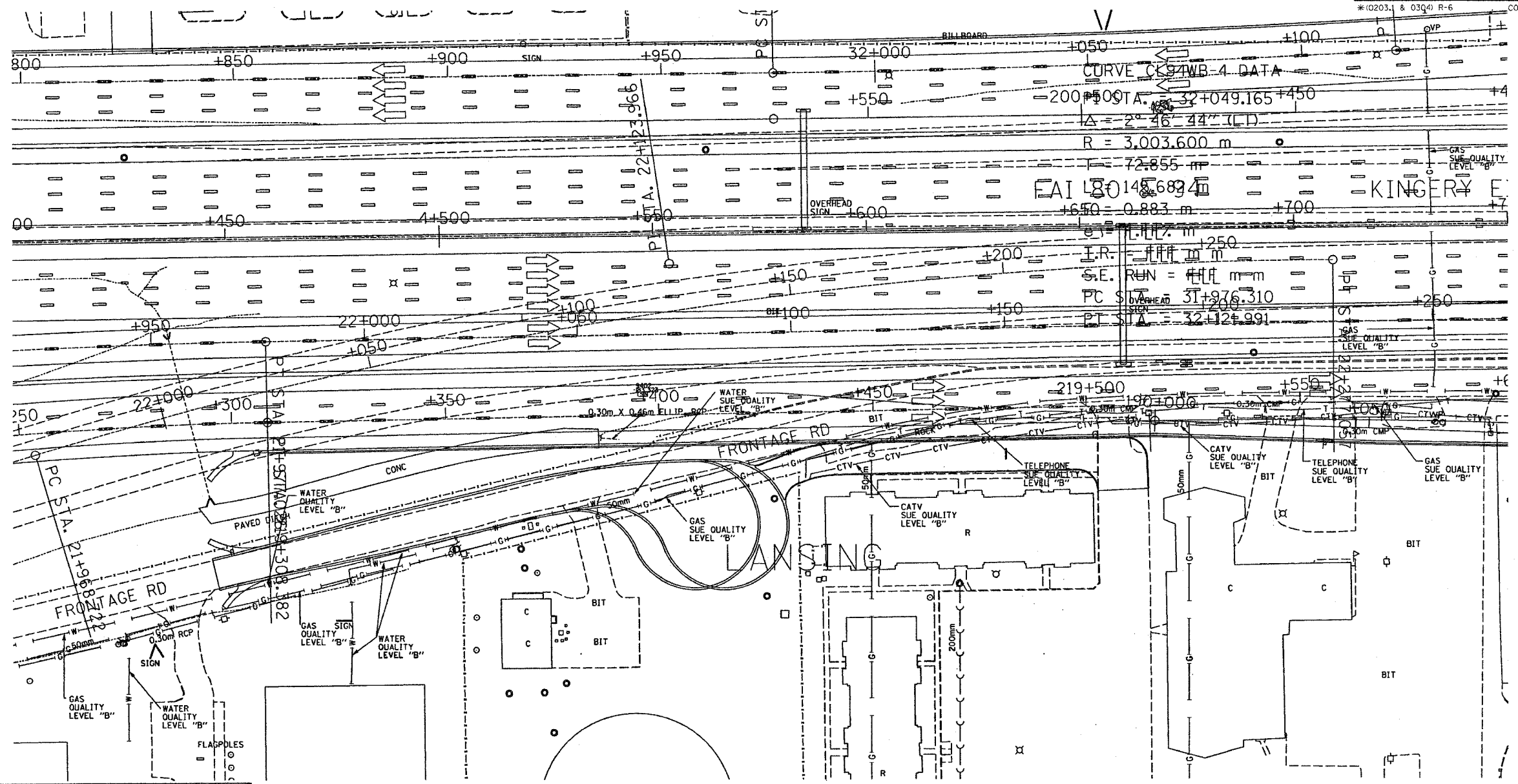

— T — T —	TELEPHONE
— W — W —	WATER
— G — G —	GAS
— CTV — CTV —	CABLE TELEVISION
— FO — FO —	FIBER OPTIC
— E — E —	ELECTRIC

TBE GROUP, INC.
 CIVIL ENGINEERING • TRANSPORTATION • ENVIRONMENTAL
 PLANNING • UTILITY ENGINEERING/LOCATING
 SOUTHERN REGION: FL, GA, SC, NC
 NORTHERN REGION: IL, IN, MI, OH, MD, NJ, NY
 PA, VA, CANADA
 WESTERN REGION: AZ, NV, NM, TX, CA, OR, UT, WA

IL09500122
 TBE SUE PAGE NO: 27 of 52
 Signature *Robert J. Demers Jr.*
 SUE Quality Level "A" : Test Holes
 SUE Quality Level "B" : Designating



205 W. WACKER DRIVE
 SUITE 1020
 CHICAGO, IL 60606
 (312) 704-1970

Utilities shown on these plans as depicted in the legend have been investigated by TBE Group, Inc in accordance with SUE Industry Standards as of 2/8/02. All other information shown has been provided to TBE Group, Inc by others.

REVISIONS		ILLINOIS DEPARTMENT OF TRANSPORTATION
NAME	DATE	
		E. of IL RT. 83/US RT. 6 to E. Burnham Ave. I-80/I-94 Burnham Ave. to State Line I-80/I-94 (Tollway) E. of I-94 to W. of RT. 83/US 6. I-94/IL RT. 394 S. of US 6 to 186th Street (Inbound & S. bound) Contract No. 62110, 62111, 62114, 62105, 62107, 62108 SCALE: 500 DRAWN BY: JAC SOL "B" DATE: 2/8/02 CHECKED BY:

SU-11