

3 PROPOSED SIGN

PLACE PROPOSED SIGN WITHIN 200' OF THE EXISTING SIGN IN RURAL AREAS. FOR PROPOSED SIGNS IN CITY LIMITS, THE SIGNS SHALL BE PLACED SO THEY DO NOT INTERFERE WITH EXISTING SIGNS AND AS DIRECTED BY THE ENGINEER.

SIGN DETAIL

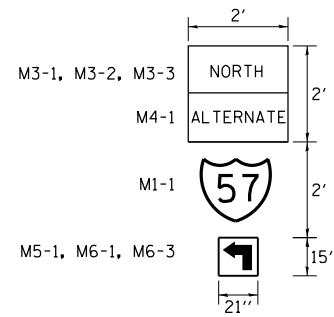

NOTES:

1. THE POSTS SHALL BE PLACED 12 FEET FROM THE EDGE OF PAVEMENT AS DIRECTED BY THE ENGINEER.
2. ALL SIGN HARDWARE REQUIRED TO INSTALL THE ALTERNATE ROUTE SIGNING SHALL BE INCLUDED IN THE COST OF SIGN PANEL TYPE 1.
3. SIGNS SHALL BE REMOVED ON COMPLETION OF THE CONTRACT AT THE DIRECTION OF THE ENGINEER. THIS WORK SHALL BE COMPLETED ACCORDING TO SECTION 724 OF THE STANDARD SPECIFICATIONS. THIS WORK WILL NOT BE PAID FOR. THE SIGNS AND POSTS SHALL BECOME THE PROPERTY OF THE CONTRACTOR.
4. THE RELOCATING, MAINTENANCE OR REPLACEMENT OF SIGNS SHALL BE PAID FOR IN ACCORDANCE WITH ARTICLE 109.04.
5. EXACT SIGN PLACEMENT WILL BE DETERMINED BY THE ENGINEER.
6. THE DISTRICT 9 OPERATIONS ENGINEER SHALL BE CONTACTED 10 DAYS PRIOR TO THE ERECTION OF SIGNS.
7. ALL SIGNS SHALL CONFORM TO THE MUTCD AND SECTION 1106 OF THE STANDARD SPECIFICATIONS.
8. ALL ALTERNATE ROUTE CHANGABLE MESSAGE BOARDS SHALL BE INCLUDED IN THE COST OF THE SMART TRAFFIC MONITORING SYSTEM

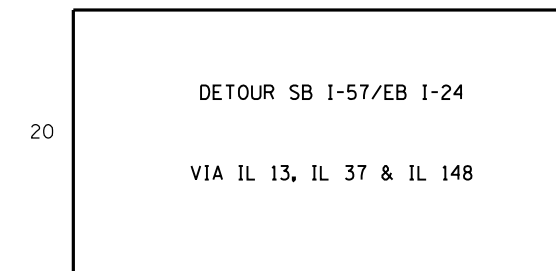
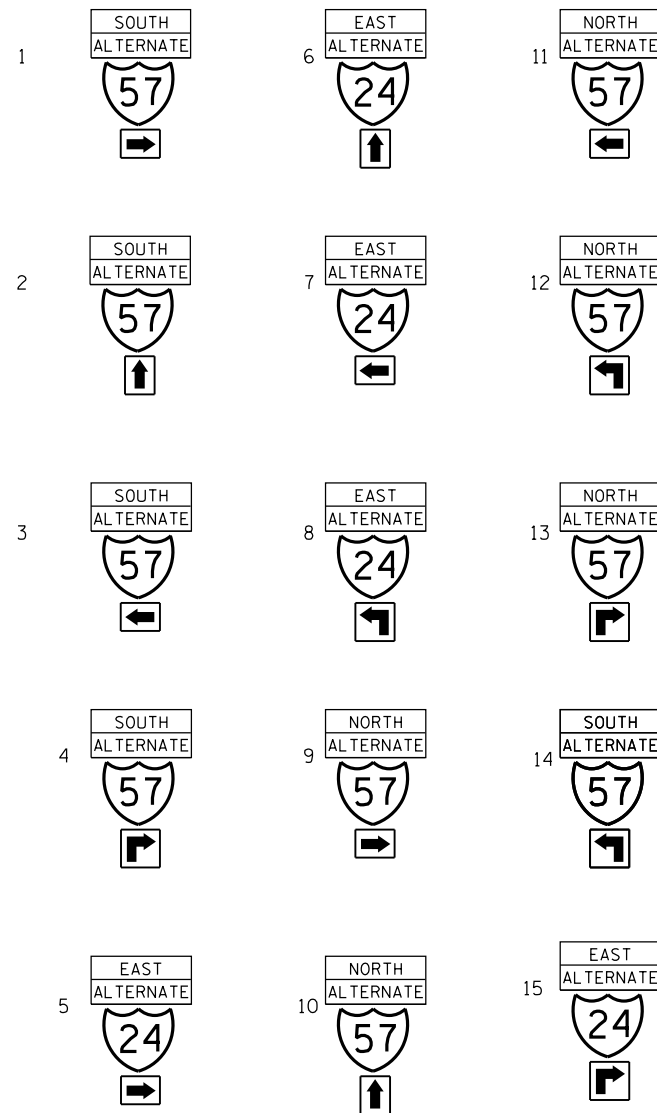

SUGGESTED MESSAGE FOR CHANGEABLE MESSAGE BOARD

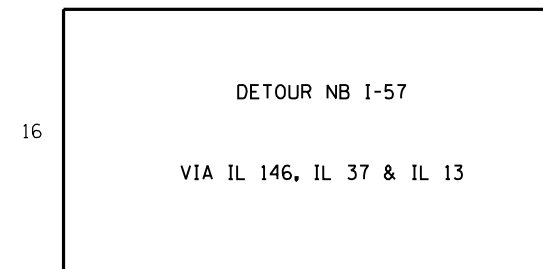

SUGGESTED MESSAGE FOR CHANGEABLE MESSAGE BOARD

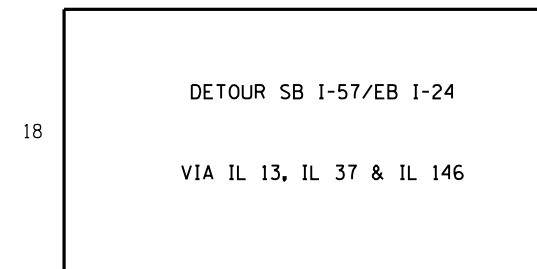

SUGGESTED MESSAGE FOR CHANGEABLE MESSAGE BOARD

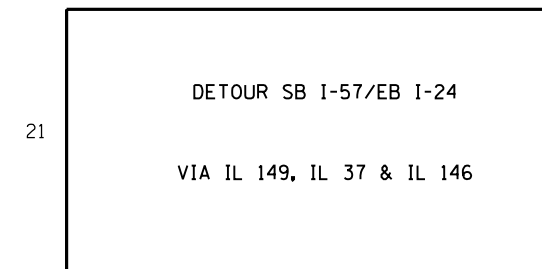

SUGGESTED MESSAGE FOR CHANGEABLE MESSAGE BOARD

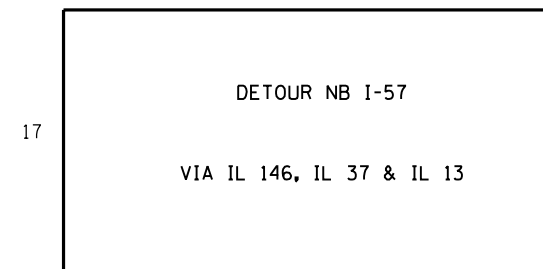

SUGGESTED MESSAGE FOR CHANGEABLE MESSAGE BOARD

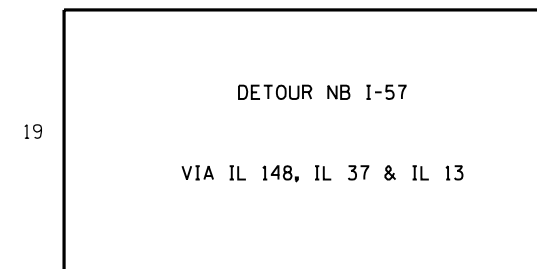

SUGGESTED MESSAGE FOR CHANGEABLE MESSAGE BOARD

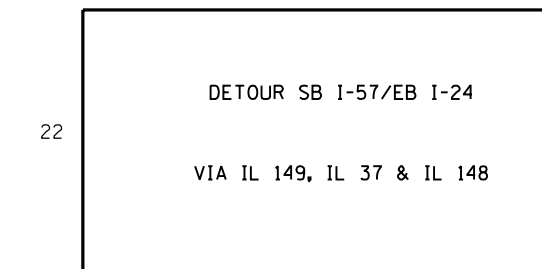

SUGGESTED MESSAGE FOR CHANGEABLE MESSAGE BOARD

FILE NAME =	USER NAME = colemm	DESIGNED -	REVISED -	STATE OF ILLINOIS DEPARTMENT OF TRANSPORTATION	ALTERNATE ROUTES SIGNING				F.A.I. RTE.	SECTION	COUNTY	TOTAL SHEETS	SHEET NO.			
Default	et:\pw\work\p\dot\colemm\d0351283\shd-stageconstruction.dgn	DRAWN -	REVISED -		SCALE:	SHEET	OF	SHEETS	STA.	TO	STA.	57	•	WILLIAMSON	107	87
	PLOT SCALE = 100.0000' / 1in.	CHECKED -	REVISED -						CONTRACT NO. 78380							
	PLOT DATE = 8/22/2014	DATE -	REVISED -						ILLINOIS FED. AID PROJECT							