

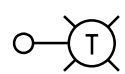

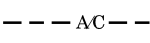



TYPICAL LAYOUT FOR TEMPORARY LIGHTING AND TRAFFIC SIGNALS

NOT TO SCALE

LEGEND

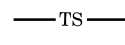
-  26,000-30,000 LUMENS, 120V, MCIII LED WITH PHOTO CELL 15' MA, 50' MH ON WOOD POLE, CLASS 4
-  3-1/C#2, AERIAL CABLE WITH MESSENGER WIRE UNLESS OTHERWISE NOTED
- TL-1A TEMPORARY LIGHTING UNIT NUMBER - ONE CIRCUIT A
-  GROUND ROD 5/8" DIA. x 10'
-  COMBINATION LIGHTING AND TRAFFIC POLE MOUNTED ELECTRICAL SERVICE BOX
-  TEMPORARY WOOD POLE - NOMINAL 60 FT., CLASS 4
-  TEMPORARY LED TRAFFIC SIGNAL HEAD, NUMBER OF SECTION AND DISPLAY AS REQUIRED.
-  TEMPORARY TRAFFIC SIGNAL SPAN WIRE, NUMBER OF CONDUCTORS AS REQUIRED.
-  TEMPORARY TRAFFIC CONTROLLER WITH UPS AND BOTTOM PLATE MOUNTED TO WOOD POLE
-  TEMPORARY VIDEO DETECTOR

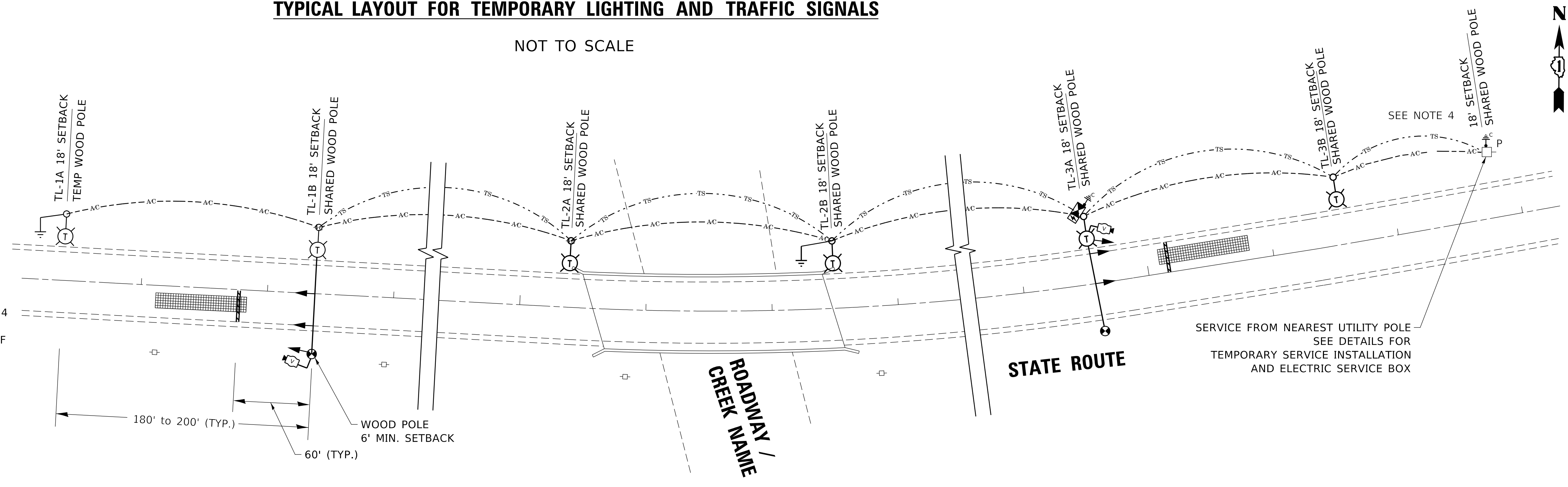



GENERAL NOTES:

1. CONTACT TO THE ELECTRIC UTILITY SHALL BE INITIATED BEFORE THE PRECONSTRUCTION MEETING, AND DOCUMENTATION OF CONTACT SHALL BE PRESENTED AT THAT MEETING. NO PLACEMENT OF POLES WILL BE ALLOWED WITHOUT EVIDENCE OF A SIGNED AGREEMENT WITH THE ELECTRIC UTILITY, FURNISHED TO THE ENGINEER.
2. UNLESS OTHERWISE INDICATED, AND EXCEPT AS OTHERWISE NOTED, THIS STANDARDIZED LAYOUT SHALL APPLY FOR BRIDGES NOT EXCEEDING A 250-FOOT SPAN. FOR BRIDGE SPANS IN EXCESS OF 250 FEET, THE POLES IMMEDIATELY ADJACENT TO THE BRIDGE SHALL BE 100-FOOT POLES (90-FOOT MOUNTING HEIGHT), WITH 56,000-60,000 LUMENS TYPE III LED HIGH-MAST LUMINAIRES AS APPROVED BY THE ENGINEER.
3. THE LAYOUT OF THE TEMPORARY EQUIPMENT WILL VARY BASED ON FIELD CONDITIONS, STAGING, UTILITY IMPACTS, AND THE ELECTRIC SERVICE LOCATION AS COORDINATED WITH THE ELECTRIC UTILITY. THE CONTRACTOR SHALL SUBMIT A PLAN INDICATING THE SETTING OF POLES, TRAFFIC SIGNALS, AND COMBINED SERVICE. THIS PLAN MUST BE APPROVED BY THE ENGINEER BEFORE ANY POLES ARE PLACED
4. THE ELECTRIC SERVICE SHALL BE 240/120V. WHERE 240V SERVICE IS NOT AVAILABLE, THE CONTRACTOR MAY SUBMIT A PROPOSAL FOR 120V SERVICE. DROP CABLE, MAIN BREAKER, AND ALL OTHER SERVICE APPURTENANCES SHALL BE APPROPRIATELY RATED AND INCLUDED REGARDLESS OF THE SERVICE VOLTAGE APPLIED.
5. THE TEMPORARY LIGHTING AND TRAFFIC SIGNAL INSTALLATION SHALL SHARE ANY COMMON ELEMENTS SUCH AS WOOD POLES, ELECTRICAL SERVICE, ELECTRIC SERVICE BOX, CABLE, ETC. THE CONTRACTOR SHALL COORDINATE TEMPORARY LIGHTING AND TRAFFIC SIGNAL INSTALLATIONS.
6. THE LIGHT POLE SETBACK FROM THE EDGE OF TRAVEL PAVEMENT SHALL BE 18 FT. UNLESS THE LIGHT POLE IS BEHIND GUARDRAIL. THE LIGHT POLES INSTALLED BEHIND THE GUARDRAIL OR BARRIER WALL SHOULD HAVE AT LEAST 8 FT. SETBACK FROM THE BACK OF THE SHOULDER AND OR AS DIRECTED BY THE ENGINEER.
7. EACH LIGHTING UNIT SHALL BE CONTROLLED BY A PHOTO CELL MOUNTED ON EACH LUMINAIRE WITH THE LIGHTING CIRCUIT FED FROM THE TEMPORARY SERVICE DISCONNECT BOX. OTHER MEANS OF LUMINAIRE CONTROL CAN BE CONSIDERED IF APPROVED BY THE ENGINEER.
8. THE CONTRACTOR SHALL SPLICE AERIAL CABLE AT THE LIGHT POLE USING HEAT SHRINKABLE CAPS WITH THE FACTORY APPLIED WATERPROOF SEALANT OR AN APPROVED UL LISTED AERIAL TAP DEVICE.
9. ALL AREAS DISTURBED UNDER THIS CONTRACT SHALL BE RESTORED TO THE ORIGINAL CONDITION OR BETTER, TO THE SATISFACTION OF THE ENGINEER.
10. THIS LAYOUT IS ONLY FOR SINGLE LANE STAGING WITHOUT PRIVATE DRIVEWAYS WITHIN SINGLE LANE WORK ZONE.

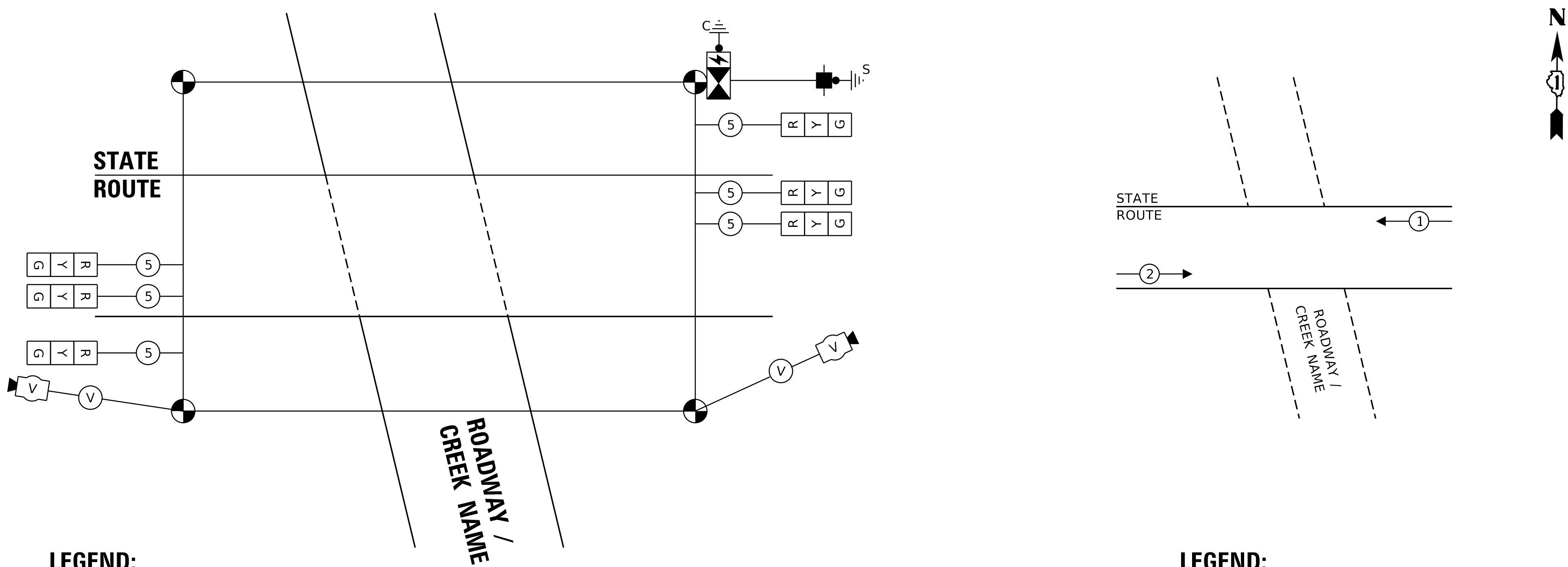
CABLE PLAN AND PHASE DESIGNATION DIAGRAM (TYPICAL)



LEGEND:

-  TEMPORARY VIDEO / RADAR DETECTOR
-  TEMPORARY SIGNAL HEAD 12" SECTION.
-  CABLE INDICATES NUMBER OF CONDUCTORS IN CABLE ALL CONDUCTORS TO BE NUMBER 14 AWG UNLESS OTHERWISE NOTED.

LEGEND:

-  NUMBER ASSOCIATED WITH PROTECTED PHASE

MODEL: Default
FILE: MainE_PlanRoom.dwg
PROJECT: I:\Projects\11815\11815.dwg
DATE: 07/28/2020 11:22:34 PM
USER: jleusa

USER NAME = jleusa	DESIGNED -	REVISED - 07/28/2020
PLOT SCALE = 50.0000' / in.	DRAWN -	REVISED -
PLOT DATE = 8/18/2020	CHECKED -	REVISED -
	DATE - 01/14/2010	REVISED -

STATE OF ILLINOIS
DEPARTMENT OF TRANSPORTATION

TEMPORARY LIGHTING AND TRAFFIC SIGNALS
FOR SINGLE LANE STAGING

SCALE: NONE SHEET 1 OF 3 SHEETS STA. TO STA.

F.A. RTE.	SECTION	COUNTY	TOTAL SHEETS	SHEET NO.
	BE-805			
ILLINOIS FED. AID PROJECT		CONTRACT NO.		