

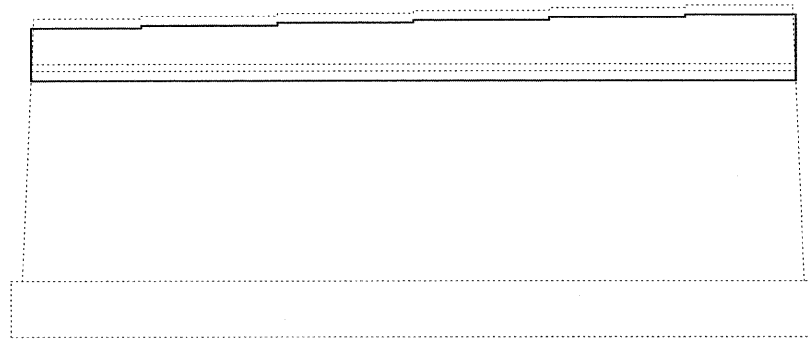

- Structural Repair of Concrete (Depth Equal to or Less Than 5")

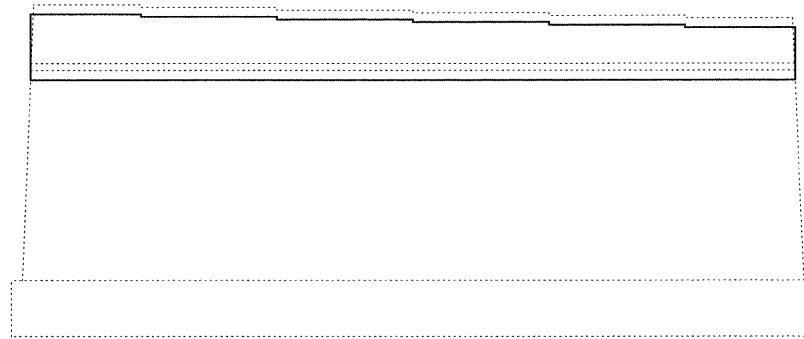

WEST BOUND PIER
(Looking North)



WEST BOUND PIER
(Looking South)



EAST BOUND PIER
(Looking North)

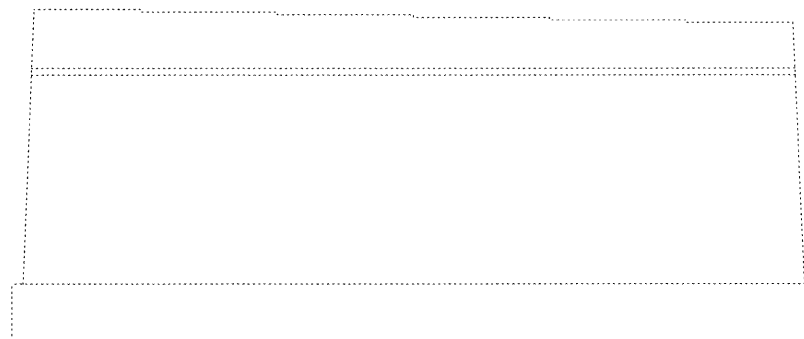

EAST BOUND PIER
(Looking South)

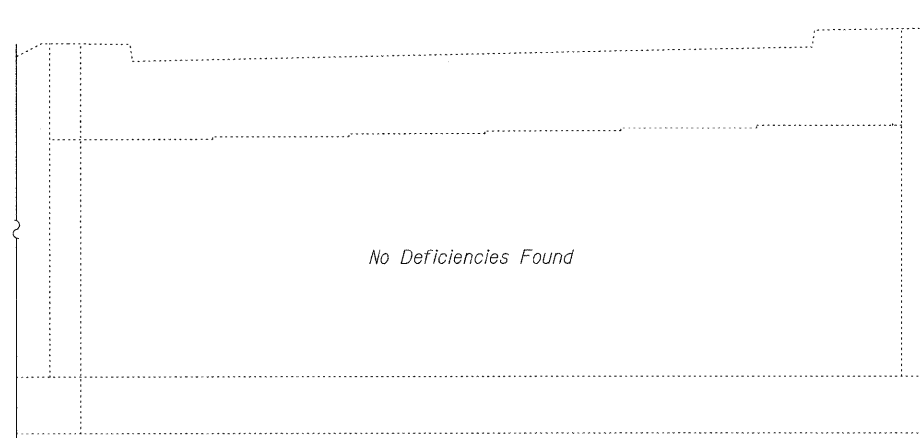

WEST BOUND NORTH ABUTMENT
(Looking North)

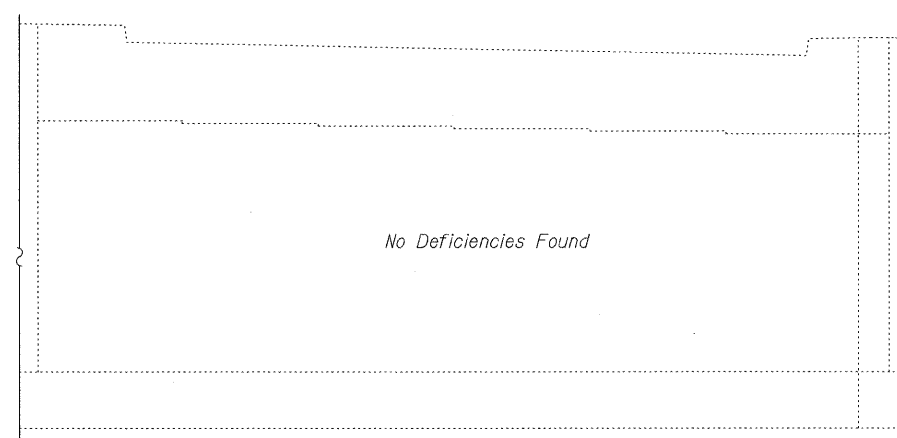

WEST BOUND SOUTH ABUTMENT
(Looking South)

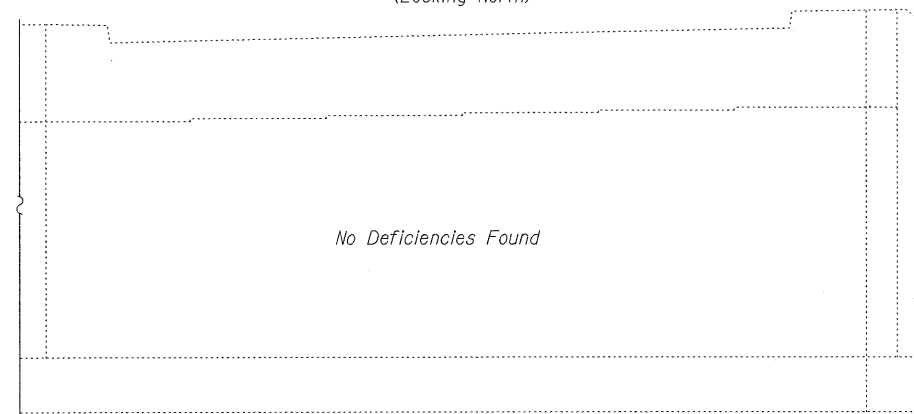

EAST BOUND NORTH ABUTMENT
(Looking North)

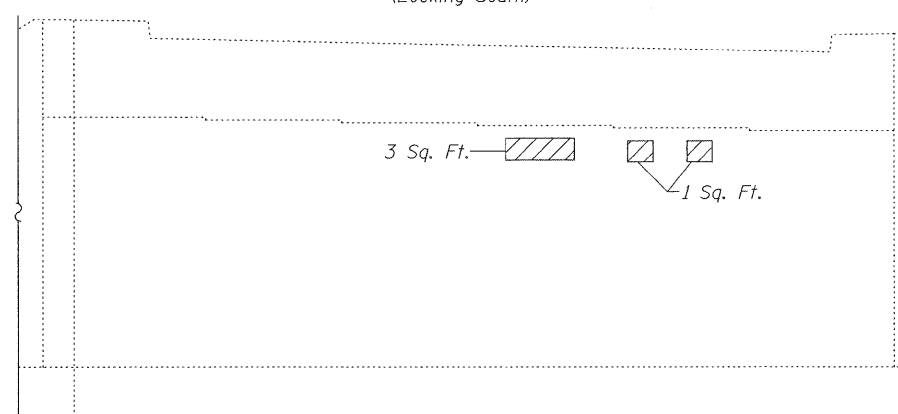

EAST BOUND SOUTH ABUTMENT
(Looking South)

BILL OF MATERIAL

Item	Unit	Total
Structural Repair of Concrete (Depth Equal to or Less Than 5")	Sq. Ft.	20

NOTE: Repair areas shown are from a survey done in 2004. Quantities have been increased to allow for additional needed repairs.

rjngroup
Excellence through Ownership

200 West Front Street
Wheaton, IL 60187

DESIGNED: WJV
CHECKED: BLB
DATE: 04/02/09

SUBSTRUCTURE REPAIR
IL RTE. 56 OVER BLACKBERRY CREEK
STATION 202+10.00
STRUCTURE NO. 045-0026 (E.B.)
STRUCTURE NO. 045-0027 (W.B.)

SHEET NO. 15	F.A.P. RTE.	SECTION	COUNTY	TOTAL SHEETS	SHEET NO.
17 SHEETS	573	61B-BR-1	KANE	37	27
			CONTRACT NO. 62817		
FED. ROAD DIST. NO. 7 ILLINOIS FED. AID PROJECT					