

PANEL SIGN DESIGN TYPE 1

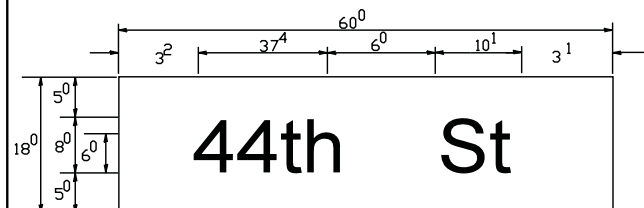

— Sq. M. each  
 7.5 Sq. Ft. each  
 2 Required  
 Design Series D

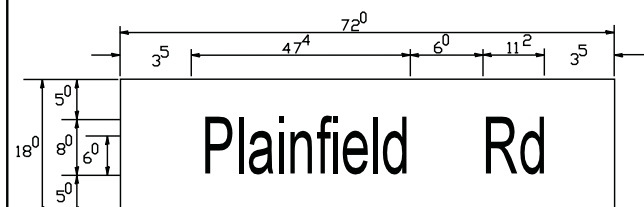

— Sq. M. each  
 9 Sq. Ft. each  
 4 Required  
 Design Series D

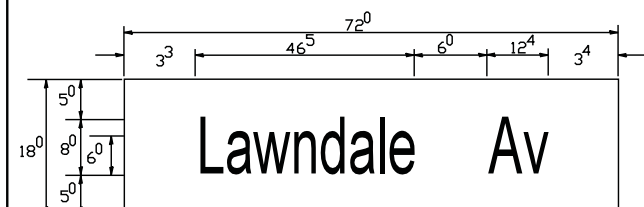

— Sq. M. each  
 9 Sq. Ft. each  
 2 Required  
 Design Series D

PANEL SIGN DESIGN TYPE 2

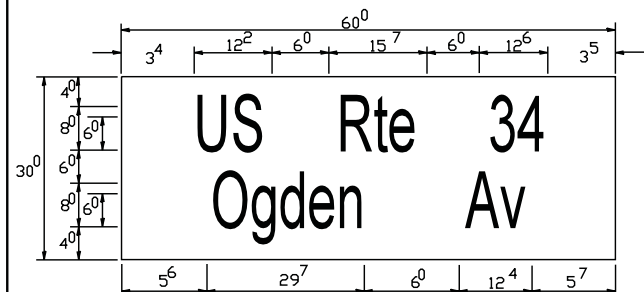

— Sq. M. each  
 12.5 Sq. Ft. each  
 4 Required  
 Design Series D

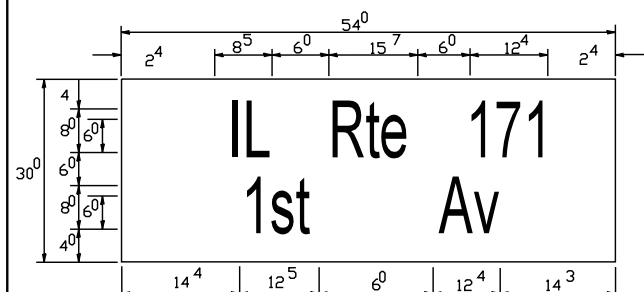

— Sq. M. each  
 11.25 Sq. Ft. each  
 6 Required  
 Design Series D

GENERAL NOTES

- WHERE MAST ARM MOUNTED STREET NAME SIGNS ARE SPECIFIED, THE MAST ARM ASSEMBLY AND POLES SHALL BE DESIGNED TO SUPPORT THE LOADINGS CALLED FOR ON STANDARDS 877001, 877002, 877006, 877011 AND 877012, AS APPLICABLE, PLUS TWO (2) SIGN PANELS 2'-6" x 8'-0" MOUNTED AS SHOWN. THE DESIGN SHALL BE IN ACCORDANCE WITH THE REQUIREMENTS OF THE CURRENT "STANDARD SPECIFICATIONS FOR STRUCTURAL SUPPORTS FOR HIGHWAY SIGNS, LUMINAIRES, AND TRAFFIC SIGNALS" AS PUBLISHED BY THE AMERICAN ASSOCIATION OF STATE HIGHWAY AND TRANSPORTATION OFFICIALS FOR 80 M.P.H. WIND VELOCITY.
- ALL SIGNS SHALL HAVE A WHITE REFLECTORIZED LEGEND AND BORDER ON A GREEN REFLECTORIZED BACKGROUND, TYPE A SHEETING.
- THE SIGN LENGTH SHOULD BE INCREASED IN 6-INCH INCREMENTS, BUT THE OVERALL LENGTH SHOULD NOT EXCEED 8'-0".
- ALL BORDERS SHALL BE 3/4" WIDE AND CORNER RADIUS SHALL BE 2-1/4".
- SIGNFIX ALUMINUM CHANNEL FRAMING SYSTEM SHALL BE USED FOR ALL SIGNS ATTACHED TO SIGNAL POLES AND POSTS. LOCAL SUPPLIERS OF THE SIGNFIX ALUMINUM CHANNEL FRAMING SYSTEM ARE:

\* J.O. HERBERT CO. MIDLOTHIAN, VA. \* WESTERN REMAC INC. WOODRIDGE, IL.

PARTS LISTING:  
 SIGN CHANNEL PART #HPN053 (MED. CHANNEL)  
 SIGN SCREWS 1/4" x 14 x 1" H.W.H. #3  
 SELF TAPPING WITH NEOPRENE WASHER  
 BRACKETS PART #HPN034 (UNIVERSAL)  
 CHANNEL CLAMPS WITH STAINLESS STEEL STRAPPING

OTHER BRANDS OF MOUNTING HARDWARE ARE ACCEPTABLE, BASED UPON THE DEPARTMENT'S APPROVAL AND COMPATIBILITY WITH THE CHANNEL/BRACKET OF THE ABOVE PRODUCT.

SUPPORTING CHANNELS

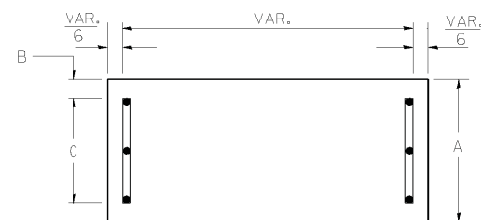

A	B	C
18"	2"	14"

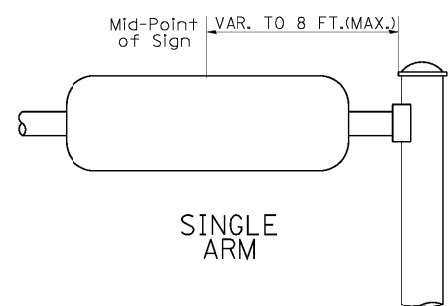

SUPPORTING CHANNELS

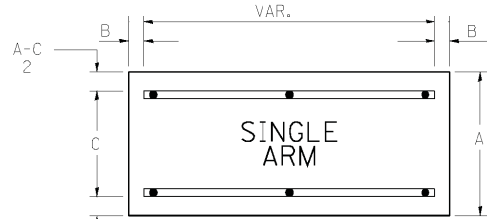

A	B	C
18"	2"	12"
30"	2"	22"

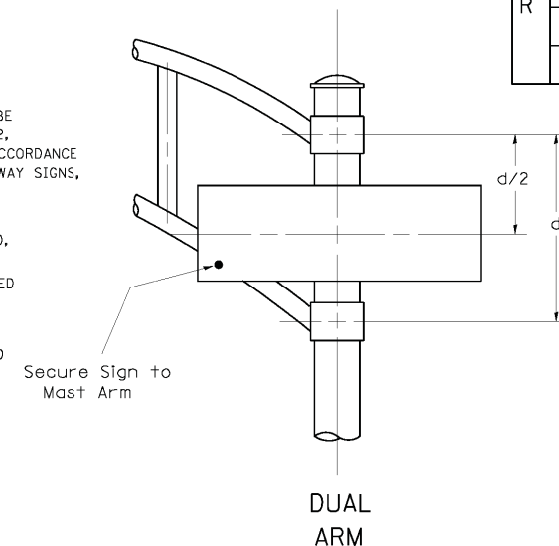

SIGNFIX ALUMINUM CHANNEL FRAMING SYSTEM shall be used. See Note #5.

Upper Case To Lower Case  
 Spacing Chart 8-6 Inch Series "C & D"

SERIES	SECOND LETTER																
	acde		g o q		bhikl		m n p r u		f w		j		s t		v y		x z
A W X	12	14	14	15	12	14	06	10	11	14	06	10	11	12	12	14	14
B	14	15	20	21	14	15	11	12	14	15	12	14	12	14	16	17	17
C E G	14	15	20	21	12	14	06	10	12	14	12	14	14	15	14	15	15
D O Q R	14	15	20	21	14	15	06	10	12	14	12	14	14	15	14	15	15
F	05	06	14	15	06	10	05	06	06	10	06	10	06	10	11	12	12
H I M N	20	21	22	24	20	21	14	15	16	17	16	17	20	21	20	21	21
J U	20	21	20	21	16	17	14	15	16	17	16	17	16	17	20	21	21
K L	11	12	16	17	11	12	05	06	11	12	11	12	11	12	12	14	14
P	12	14	14	15	12	14	05	06	11	12	11	12	12	14	12	14	14
S	12	14	16	17	12	14	06	10	12	14	12	14	12	14	12	14	14
T	11	12	16	17	06	10	06	10	11	12	11	12	11	12	12	14	14
V	06	10	14	15	11	12	06	10	12	14	12	14	12	14	12	14	14
Y	05	06	14	15	06	10	05	06	05	07	05	06	06	10	11	12	12
Z	16	17	22	24	16	17	12	14	16	17	16	17	16	17	20	21	21

Lower Case To Lower Case  
 Spacing Chart 6 Inch Series "C & D"

SERIES	SECOND LETTER																
	acde		g o q		bhikl		m n p r u		f w		j		s t		v y		x z
ad h g i j	16	17	22	24	16	17	12	14	14	15	14	15	16	17	16	17	17
l m n q u	16	17	22	24	16	17	12	14	14	15	14	15	16	17	16	17	17
b f k o p s	12	14	16	17	11	12	05	06	11	12	11	12	12	14	12	14	14
c e	12	14	16	17	12	14	06	10	12	14	12	14	12	14	12	14	14
r	06	10	12	14	06	10	03	03	05	06	05	06	06	10	06	10	10
t z	12	14	16	17	12	14	06	10	11	12	11	12	12	14	12	14	14
v y	11	12	14	15	11	12	05	06	05	07	05	06	06	10	11	12	12
w	11	12	14	15	11	12	05	06	11	12	11	12	11	12	12	14	14
x	12	14	16	17	11	12	05	06	11	12	11	12	11	12	12	14	14

Number To Number  
 Spacing Chart 8 Inch Series "C & D"

SERIES	SECOND NUMBER																			
	0		1		2		3		4		5		6		7		8		9	
0 9	16	17	16	17	14	15	12	14	14	15	14	15	16	17	12	14	16	17	16	17
1	20	21	20	21	20	21	16	17	14	15	20	21	20	21	14	15	20	21	20	21
2 3 4	14	15	14	15	14	15	12	14	12	14	14	15	14	15	11	12	16	17	14	15
5	14	15	14	15	14	15	11	12	11	12	14	15	14	15	11	12	14	15	14	15
6	16	17	14	15	14	15	12	14	14	15	14	15	11	12	14	15	14	15	14	15
7	12	14	12	14	14	15	12	15	05	06	12	14	14	15	11	12	14	15	12	14
8	16	17	16	17	14	15	12	15	12	14	14	15	16	17	12	14	16	17	14	15

EXAMPLE, 2<sup>3</sup> DENOTES 3/8"

UPPER AND LOWER CASE  
 LETTER WIDTHS

LETTERS	6 INCH UPPER CASE LETTERS		8 INCH UPPER CASE LETTERS		LETTERS	6 INCH LOWER CASE LETTERS	
	SERIES		SERIES			SERIES	
	C	D	C	D		C	D
A	3 <sup>6</sup>	5 <sup>0</sup>	5 <sup>0</sup>	6 <sup>5</sup>	a	3 <sup>5</sup>	4 <sup>2</sup>
B	3 <sup>2</sup>	4 <sup>0</sup>	4 <sup>3</sup>	5 <sup>3</sup>	b	3 <sup>5</sup>	4 <sup>2</sup>
C	3 <sup>2</sup>	4 <sup>0</sup>	4 <sup>3</sup>	5 <sup>3</sup>	c	3 <sup>5</sup>	4 <sup>1</sup>
D	3 <sup>2</sup>	4 <sup>0</sup>	4 <sup>3</sup>	5 <sup>3</sup>	d	3 <sup>5</sup>	4 <sup>2</sup>
E	3 <sup>0</sup>	3 <sup>5</sup>	4 <sup>0</sup>	4 <sup>7</sup>	e	3 <sup>5</sup>	4 <sup>2</sup>
F	3 <sup>0</sup>	3 <sup>5</sup>	4 <sup>0</sup>	4 <sup>7</sup>	f	2 <sup>3</sup>	2 <sup>6</sup>
G	3 <sup>2</sup>	4 <sup>0</sup>	4 <sup>3</sup>	5 <sup>3</sup>	g	3 <sup>5</sup>	4 <sup>2</sup>
H	3 <sup>2</sup>	4 <sup>0</sup>	4 <sup>3</sup>	5 <sup>3</sup>	h	3 <sup>5</sup>	4 <sup>2</sup>
I	0 <sup>7</sup>	0 <sup>7</sup>	1 <sup>1</sup>	1 <sup>2</sup>	i	1 <sup>1</sup>	1 <sup>1</sup>
J	3 <sup>0</sup>	3 <sup>6</sup>	4 <sup>0</sup>	5 <sup>0</sup>	j	2 <sup>0</sup>	2 <sup>2</sup>
K	3 <sup>2</sup>	4 <sup>1</sup>	4 <sup>3</sup>	5 <sup>4</sup>	k	3 <sup>5</sup>	4 <sup>2</sup>
L	3 <sup>0</sup>	3 <sup>5</sup>	4 <sup>0</sup>	4 <sup>7</sup>	l	1 <sup>1</sup>	1 <sup>1</sup>
M	3 <sup>7</sup>	4 <sup>5</sup>	5 <sup>1</sup>	6 <sup>1</sup>	m	6 <sup>0</sup>	7 <sup>0</sup>
N	3 <sup>2</sup>	4 <sup>0</sup>	4 <sup>3</sup>	5 <sup>3</sup>	n	3 <sup>5</sup>	4 <sup>2</sup>
O	3 <sup>4</sup>	4 <sup>2</sup>	4 <sup>5</sup>	5 <sup>5</sup>	o	3 <sup>6</sup>	4 <sup>3</sup>
P	3 <sup>2</sup>	4 <sup>0</sup>	4 <sup>3</sup>	5 <sup>3</sup>	p	3 <sup>5</sup>	4 <sup>2</sup>
Q	3 <sup>4</sup>	4 <sup>2</sup>	4 <sup>5</sup>	5 <sup>5</sup>	q	3 <sup>5</sup>	4 <sup>2</sup>
R	3 <sup>2</sup>	4 <sup>0</sup>	4 <sup>3</sup>	5 <sup>3</sup>	r	2 <sup>6</sup>	3 <sup>2</sup>
S	3 <sup>2</sup>	4 <sup>0</sup>	4 <sup>3</sup>	5 <sup>3</sup>	s	3 <sup>6</sup>	4 <sup>2</sup>
T	3 <sup>0</sup>	3 <sup>5</sup>	4 <sup>0</sup>	4 <sup>7</sup>	t	2 <sup>7</sup>	3 <sup>2</sup>
U	3 <sup>2</sup>	4 <sup>0</sup>	4 <sup>3</sup>	5 <sup>3</sup>	u	3 <sup>5</sup>	4 <sup>2</sup>
V	3 <sup>5</sup>	4 <sup>4</sup>	4 <sup>7</sup>	6 <sup>0</sup>	v	4 <sup>2</sup>	4 <sup>7</sup>
W	4 <sup>4</sup>	5 <sup>2</sup>	6 <sup>0</sup>	7 <sup>0</sup>	w	5 <sup>5</sup>	6 <sup>4</sup>
X	3 <sup>4</sup>	4 <sup>0</sup>	4 <sup>5</sup>	5 <sup>3</sup>	x	4 <sup>4</sup>	5 <sup>1</sup>
Y	3 <sup>6</sup>	5 <sup>0</sup>	5 <sup>0</sup>	6 <sup>6</sup>	y	4 <sup>6</sup>	5 <sup>3</sup>
Z	3 <sup>2</sup>	4 <sup>0</sup>	4 <sup>3</sup>	5 <sup>3</sup>	z	3 <sup>6</sup>	4 <sup>3</sup>

NUMBER	6 INCH SERIES		8 INCH SERIES	
	C	D	C	D
1	1 <sup>2</sup>	1 <sup>4</sup>	1 <sup>5</sup>	2 <sup>0</sup>
2	3 <sup>2</sup>	4 <sup>0</sup>	4 <sup>3</sup>	5 <sup>3</sup>
3	3 <sup>2</sup>	4 <sup>0</sup>	4 <sup>3</sup>	5 <sup>3</sup>
4	3 <sup>5</sup>	4 <sup>3</sup>	4 <sup>7</sup>	5 <sup>7</sup>
5	3 <sup>2</sup>	4 <sup>0</sup>	4 <sup>3</sup>	5 <sup>3</sup>
6	3 <sup>2</sup>	4 <sup>0</sup>	4 <sup>3</sup>	5 <sup>3</sup>
7	3 <sup>2</sup>	4 <sup>0</sup>	4 <sup>3</sup>	5 <sup>3</sup>
8	3 <sup>2</sup>	4 <sup>0</sup>	4 <sup>3</sup>	5 <sup>3</sup>
9	3 <sup>2</sup>	4 <sup>0</sup>	4 <sup>3</sup>	5 <sup>3</sup>
0	3 <sup>4</sup>	4 <sup>2</sup>	4 <sup>5</sup>	5 <sup>5</sup>

FILE NAME =	USER NAME = \$USER\$	DESIGNED - DW	REVISED -
N:\Projects\312055\DesignCAD\Sheet Files\60V34RWA-MAMSIGN.dgn		DRAWN - LV	REVISED -
		CHECKED - KM	REVISED -
		DATE - 9/25/2012	REVISED -

STATE OF ILLINOIS  
 DEPARTMENT OF TRANSPORTATION

MAST ARM MOUNTED  
 STREET NAME SIGNS

SCALE: N.T.S. SHEET NO. OF SHEETS STA. TO STA.

F.A.P. RTE. 372	SECTION 2012-0471	COUNTY COOK	TOTAL SHEETS 63	SHEET NO. 52
CONTRACT NO. 60V34				
ILLINOIS FED. AID PROJECT				