

**INDEX OF SHEETS**

- 1. COVER SHEET
- 2. GENERAL NOTES
- 3 - 5. SUMMARY OF QUANTITIES
- 6. WORK ORDER
- 7. PAVEMENT MARKING SUMMARY
- 8 - 15. TYPICAL PAVEMENT MARKING

**HIGHWAY STANDARDS**

- 701001-02 OFF-ROAD OPERATIONS 2L, 2W, MORE THAN 15' AWAY
- 701006-05 OFF-ROAD OPERATIONS 2L, 2W, 15' TO 24" FROM PAVEMENT EDGE
- 701101-05 OFF-ROAD OPERATIONS, MULTILANE, 15' TO 24" FROM PAVEMENT EDGE
- 701106-02 OFF-ROAD OPERATIONS, MULTILANE, MORE THAN 15' AWAY
- 701201-05 LANE CLOSURE, 2L, 2W, DAY ONLY, FOR SPEEDS ≥ 45 MPH
- 701301-04 LANE CLOSURE, 2L, 2W, SHORT TIME OPERATIONS
- 701311-03 LANE CLOSURE, 2L, 2W, MOVING OPERATIONS - DAY ONLY
- 701400-12 APPROACH TO LANE CLOSURE, FREEWAY/EXPRESSWAY
- 701401-13 LANE CLOSURE, FREEWAY/EXPRESSWAY
- 701406-13 LANE CLOSURE, FREEWAY/EXPRESSWAY, DAY OPERATIONS ONLY
- 701411-09 LANE CLOSURE, MULTILANE, AT ENTRANCE OR EXIT RAMP FOR SPEEDS ≥ 45 MPH
- 701426-09 LANE CLOSURE, MULTILANE INTERMITTENT OR MOVING OPERATION, FOR SPEEDS ≥ 45 MPH
- 701427-05 LANE CLOSURE, MULTILANE INTERMITTENT OR MOVING OPERATION, FOR SPEEDS ≤ 40 MPH
- 701428-01 TRAFFIC CONTROL, SETUP AND REMOVAL, FREEWAY/EXPRESSWAY
- 701501-06 URBAN LANE CLOSURE, 2L, 2W, UNDIVIDED
- 701502-09 URBAN LANE CLOSURE 2L, 2W, WITH BIDIRECTIONAL LEFT TURN LANE
- 701601-09 URBAN LANE CLOSURE, MULTILANE, 1W OR 2W WITH NONTRAVERSABLE MEDIAN
- 701602-10 URBAN LANE CLOSURE, MULTILANE, 2W WITH BIDIRECTIONAL LEFT TURN LANE
- 701701-10 URBAN LANE CLOSURE, MULTILANE INTERSECTION
- 701901-10 TRAFFIC CONTROL DEVICES

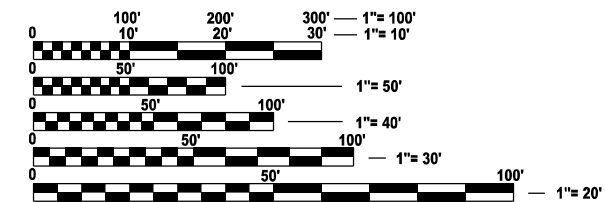

FULL SIZE PLANS HAVE BEEN PREPARED USING STANDARD ENGINEERING SCALES. REDUCED SIZED PLANS WILL NOT CONFORM TO STANDARD SCALES. IN MAKING MEASUREMENTS ON REDUCED PLANS, THE ABOVE SCALES MAY BE USED.

**J.U.L.I.E.**  
**JOINT UTILITY LOCATION INFORMATION FOR EXCAVATION**  
 1-800-892-0123  
 OR 811

**PROJECT ENGINEER: AMANDA SRAMEK**  
**PROJECT MANAGER: RON WOODSHANK**  
**DISTRICT NO. 3 (815) 434-6131**  
**CONTRACT NO. 46655**

**STATE OF ILLINOIS**  
**DEPARTMENT OF TRANSPORTATION**

**PROPOSED**  
**HIGHWAY PLANS**

**VARIOUS ROUTES**  
**SECTION D 3 HT PVMNT MRK RPR 25-12**  
**HIGH TYPE PAVEMENT MARKING**  
**VARIOUS COUNTIES**

M-60-013-25

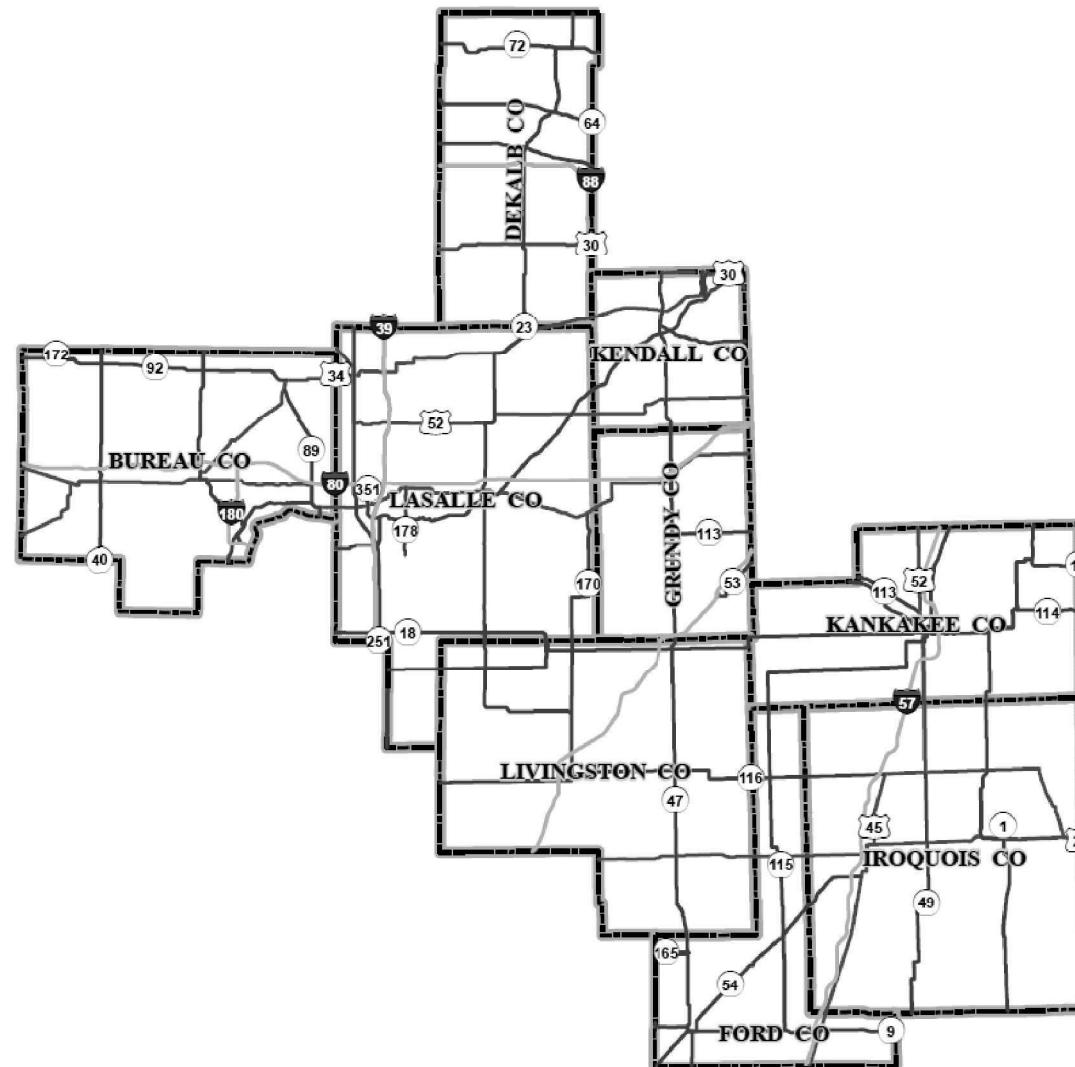

F.A. RTE.	SECTION	COUNTY	TOTAL SHEETS	SHEET NO.
VAR	D 3 HT PVMNT MRK RPR 25-12	VARIOUS	15	1
		ILLINOIS	CONTRACT NO. 46655	

D-93-008-24

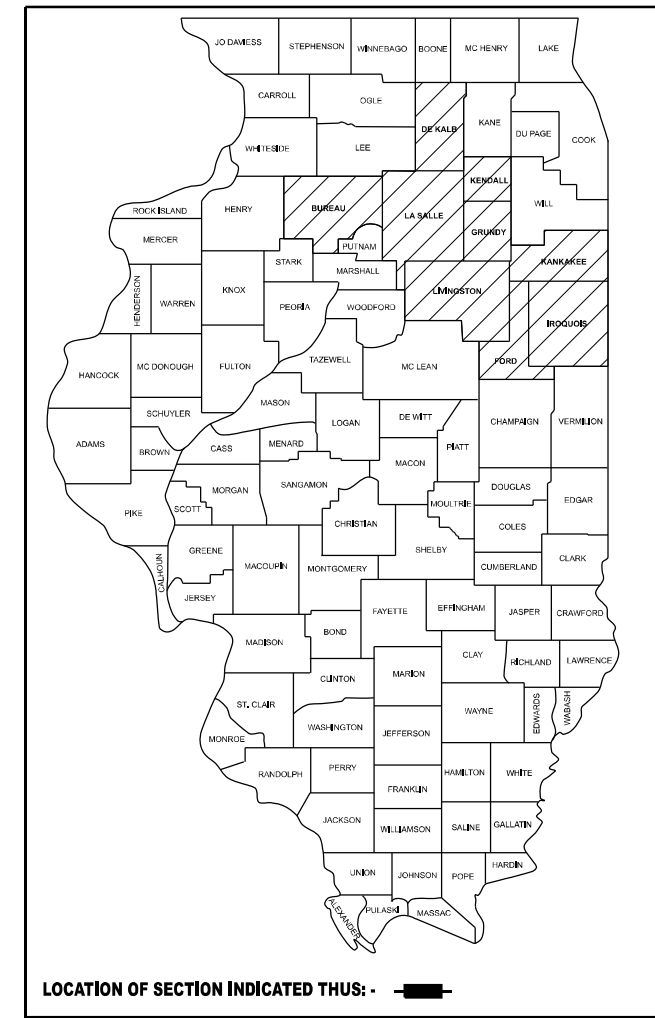

STATE OF ILLINOIS  
 DEPARTMENT OF TRANSPORTATION

SUBMITTED October 16, 2024

*Trisha Thompson*  
 REGIONAL ENGINEER

December 6, 2024

*Scott A. Clark*  
 ENGINEER OF DESIGN AND ENVIRONMENT

December 6, 2024

*James J. Quinn*  
 DIRECTOR OF HIGHWAYS PROJECT IMPLEMENTATION

**PRINTED BY THE AUTHORITY**  
**OF THE STATE OF ILLINOIS**



MODEL: D:\infuit...  
 FILE NAME: D:\infuit...  
 MODEL: D:\infuit...  
 FILE NAME: D:\infuit...

CODE NO.	ITEM	UNIT	TOTAL QUANTITY	CONSTRUCTION CODE	
				PAVEMENT MARKING 100% STATE	
				PAVEMENT MARKING 0021	NONE
78000100	THERMOPLASTIC PAVEMENT MARKING - LETTERS AND SYMBOLS	SQ FT	2000	2000	
78000200	THERMOPLASTIC PAVEMENT MARKING - LINE 4"	FOOT	8000	8000	
78000400	THERMOPLASTIC PAVEMENT MARKING - LINE 6"	FOOT	1000	1000	
78000500	THERMOPLASTIC PAVEMENT MARKING - LINE 8"	FOOT	3000	3000	
78000600	THERMOPLASTIC PAVEMENT MARKING - LINE 12"	FOOT	1000	1000	
78000650	THERMOPLASTIC PAVEMENT MARKING - LINE 24"	FOOT	1000	1000	
78001110	PAINT PAVEMENT MARKING - LINE 4"	FOOT	75000	75000	
78001130	PAINT PAVEMENT MARKING - LINE 6"	FOOT	40000	40000	
78004630	PREFORMED PLASTIC PAVEMENT MARKING, TYPE D - STANDARD - LINE 6"	FOOT	25000	25000	
78004640	PREFORMED PLASTIC PAVEMENT MARKING, TYPE D - STANDARD - LINE 8"	FOOT	10000	10000	
78004645	PREFORMED PLASTIC PAVEMENT MARKING, TYPE D - STANDARD - LINE 9"	FOOT	16000	16000	
78004720	PREFORMED PLASTIC PAVEMENT MARKING, TYPE D - STANDARD - LINE 24"	FOOT	1000	1000	
78005110	EPOXY PAVEMENT MARKING - LINE 4"	FOOT	725000	725000	
78005130	EPOXY PAVEMENT MARKING - LINE 6"	FOOT	1000	1000	

USER NAME = ronald.woodshank	DESIGNED - RW	REVISED -
DRAWN - RW	CHECKED - YP	REVISED -
PLOT SCALE = \$SCALE\$	DATE - 7/28/2023	REVISED -
PLOT DATE = 9/24/2024		

**STATE OF ILLINOIS  
DEPARTMENT OF TRANSPORTATION**

**SUMMARY OF QUANTITIES**

SCALE: SHEET 1 OF 3 SHEETS STA. TO STA.

F.A. RTE.	SECTION	COUNTY	TOTAL SHEETS	SHEET NO.
VAR	D 3 HT PVMNT MRK RPR 25-12	VARIOUS	15	3
			CONTRACT NO. 46655	
		ILLINOIS	FED. AID PROJECT	

MODEL: D:\inf\...  
 FILE NAME: ...

CODE NO.	ITEM	UNIT	TOTAL QUANTITY	CONSTRUCTION CODE	
				PAVEMENT MARKING 100% STATE	
				PAVEMENT MARKING 0021	NONE
78005140	EPOXY PAVEMENT MARKING - LINE 8"	FOOT	4000	4000	
78008210	POLYUREA PAVEMENT MARKING TYPE I - LINE 4"	FOOT	100000	100000	
78008230	POLYUREA PAVEMENT MARKING TYPE I - LINE 6"	FOOT	50000	50000	
78008240	POLYUREA PAVEMENT MARKING TYPE I - LINE 8"	FOOT	25000	25000	
78009000	MODIFIED URETHANE PAVEMENT MARKING - LETTERS AND SYMBOLS	SQ FT	8000	8000	
78009004	MODIFIED URETHANE PAVEMENT MARKING - LINE 4"	FOOT	475000	475000	
78009006	MODIFIED URETHANE PAVEMENT MARKING - LINE 6"	FOOT	95000	95000	
78009008	MODIFIED URETHANE PAVEMENT MARKING - LINE 8"	FOOT	60000	60000	
78009012	MODIFIED URETHANE PAVEMENT MARKING - LINE 12"	FOOT	8000	8000	
78009024	MODIFIED URETHANE PAVEMENT MARKING - LINE 24"	FOOT	3000	3000	
78011000	GROOVING FOR RECESSED PAVEMENT MARKING, LETTERS AND SYMBOLS	SQ FT	4000	4000	
78011025	GROOVING FOR RECESSED PAVEMENT MARKING 5"	FOOT	200000	200000	
78011035	GROOVING FOR RECESSED PAVEMENT MARKING 7"	FOOT	55000	55000	
78011045	GROOVING FOR RECESSED PAVEMENT MARKING 9"	FOOT	5000	5000	

USER NAME = ronald.woodshank	DESIGNED - RW	REVISED -
DRAWN - RW	CHECKED - YP	REVISED -
PLOT SCALE = \$SCALE\$	DATE - 7/28/2023	REVISED -
PLOT DATE = 9/24/2024		

**STATE OF ILLINOIS  
 DEPARTMENT OF TRANSPORTATION**

**SUMMARY OF QUANTITIES**

SCALE: SHEET 2 OF 3 SHEETS STA. TO STA.

F.A. RTE.	SECTION	COUNTY	TOTAL SHEETS	SHEET NO.
VAR	D 3 HT PVMNT MRK RPR 25-12	VARIOUS	15	4
			CONTRACT NO. 46655	
		ILLINOIS FED. AID PROJECT		

MODEL: D:\inf\...  
 FILE NAME: ...

CODE NO.	ITEM	UNIT	TOTAL QUANTITY	CONSTRUCTION CODE	
				PAVEMENT MARKING 100% STATE	
				PAVEMENT MARKING 0021	NONE
78011050	GROOVING FOR RECESSED PAVEMENT MARKING 10'	FOOT	7500	7500	
78011065	GROOVING FOR RECESSED PAVEMENT MARKING 13'	FOOT	500	500	
78011125	GROOVING FOR RECESSED PAVEMENT MARKING 25'	FOOT	1000	1000	
78300201	PAVEMENT MARKING REMOVAL - GRINDING	SQ FT	40000	40000	
78300202	PAVEMENT MARKING REMOVAL - WATER BLASTING	SQ FT	1000	1000	
X7800815	HOT SPRAY THERMOPLASTIC PAVEMENT MARKING LINE - 4 INCH	FOOT	70000	70000	
X7800835	HOT SPRAY THERMOPLASTIC PAVEMENT MARKING LINE - 6 INCH	FOOT	30000	30000	
X7800845	HOT SPRAY THERMOPLASTIC PAVEMENT MARKING LINE - 8 INCH	FOOT	5000	5000	
Z0008758	AERIAL SPEED CHECK MARKING	FOOT	200	200	

USER NAME = ronald.woodshank	DESIGNED - RW	REVISED -
DRAWN - RW	CHECKED - YP	REVISED -
PLOT SCALE = \$SCALE\$	DATE - 7/28/2023	REVISED -
PLOT DATE = 9/24/2024		

**STATE OF ILLINOIS  
 DEPARTMENT OF TRANSPORTATION**

SUMMARY OF QUANTITIES			
SCALE:	SHEET 3 OF 3 SHEETS	STA.	TO STA.

F.A. RTE.	SECTION	COUNTY	TOTAL SHEETS	SHEET NO.
VAR	D 3 HT PVMNT MRK RPR 25-12	VARIOUS	15	5
			CONTRACT NO. 46655	
		ILLINOIS	FED. AID PROJECT	

**WORK ORDER  
D3 HT PVMNT MRKG RPR 25-12**

**WORK ORDER NO.** \_\_\_\_\_ **DATE ISSUED** \_\_\_\_\_ **ROUTE** \_\_\_\_\_

**LOCATION DESCRIPTION** \_\_\_\_\_

**CONTRACT NO.:** 46655 **JOB NO.:** M-60-013-25

CODE NUMBER	ITEM	UNIT	QUANTITY	UNIT PRICE	ITEM COST
78000100	THERMOPLASTIC PAVEMENT MARKING - LETTERS AND SYMBOLS	SQ FT	2,000.00		
78000200	THERMOPLASTIC PAVEMENT MARKING - LINE 4"	FOOT	8,000.00		
78000400	THERMOPLASTIC PAVEMENT MARKING - LINE 6"	FOOT	1,000.00		
78000500	THERMOPLASTIC PAVEMENT MARKING - LINE 8"	FOOT	3,000.00		
78000600	THERMOPLASTIC PAVEMENT MARKING - LINE 12"	FOOT	1,000.00		
78000650	THERMOPLASTIC PAVEMENT MARKING - LINE 24"	FOOT	1,000.00		
78001110	PAINT PAVEMENT MARKING - LINE 4"	FOOT	75,000.00		
78001130	PAINT PAVEMENT MARKING - LINE 6"	FOOT	40,000.00		
78004630	PREFORMED PLASTIC PAVEMENT MARKING, TYPE D - STANDARD - LINE 6"	FOOT	25,000.00		
78004640	PREFORMED PLASTIC PAVEMENT MARKING, TYPE D - STANDARD - LINE 8"	FOOT	10,000.00		
78004645	PREFORMED PLASTIC PAVEMENT MARKING, TYPE D - STANDARD - LINE 9"	FOOT	16,000.00		
78004720	PREFORMED PLASTIC PAVEMENT MARKING, TYPE D - STANDARD - LINE 24"	FOOT	1,000.00		
78005110	EPOXY PAVEMENT MARKING - LINE 4"	FOOT	725,000.00		
78005130	EPOXY PAVEMENT MARKING - LINE 6"	FOOT	1,000.00		
78005140	EPOXY PAVEMENT MARKING - LINE 8"	FOOT	4,000.00		
78008210	POLYUREA PAVEMENT MARKING TYPE I - LINE 4"	FOOT	100,000.00		
78008230	POLYUREA PAVEMENT MARKING TYPE I - LINE 6"	FOOT	50,000.00		
78008240	POLYUREA PAVEMENT MARKING TYPE I - LINE 8"	FOOT	25,000.00		
78009000	MODIFIED URETHANE PAVEMENT MARKING - LETTERS AND SYMBOLS	SQ FT	8,000.00		
78009004	MODIFIED URETHANE PAVEMENT MARKING - LINE 4"	FOOT	475,000.00		
78009006	MODIFIED URETHANE PAVEMENT MARKING - LINE 6"	FOOT	95,000.00		
78009008	MODIFIED URETHANE PAVEMENT MARKING - LINE 8"	FOOT	60,000.00		
78009012	MODIFIED URETHANE PAVEMENT MARKING - LINE 12'	FOOT	8,000.00		
78009024	MODIFIED URETHANE PAVEMENT MARKING - LINE 24'	FOOT	3,000.00		
78011000	GROOVING FOR RECESSED PAVEMENT MARKING, LETTERS AND SYMBOLS	SQ FT	4,000.00		
78011025	GROOVING FOR RECESSED PAVEMENT MARKING 5"	FOOT	200,000.00		
78011035	GROOVING FOR RECESSED PAVEMENT MARKING 7"	FOOT	55,000.00		
78011045	GROOVING FOR RECESSED PAVEMENT MARKING 9"	FOOT	5,000.00		
78011050	GROOVING FOR RECESSED PAVEMENT MARKING 10"	FOOT	7,500.00		
78011065	GROOVING FOR RECESSED PAVEMENT MARKING 13"	FOOT	500.00		
78011125	GROOVING FOR RECESSED PAVEMENT MARKING 25"	FOOT	1,000.00		
78300201	PAVEMENT MARKING REMOVAL - GRINDING	SQ FT	40,000.00		
78300202	PAVEMENT MARKING REMOVAL - WATER BLASTING	SQ FT	1,000.00		
X7800815	HOT SPRAY THERMOPLASTIC PAVEMENT MARKING LINE - 4 INCH	FOOT	70,000.00		
X7800835	HOT SPRAY THERMOPLASTIC PAVEMENT MARKING LINE - 6 INCH	FOOT	30,000.00		
X7800845	HOT SPRAY THERMOPLASTIC PAVEMENT MARKING LINE - 8 INCH	FOOT	5,000.00		
Z0008758	AERIAL SPEED CHECK MARKING	FOOT	200.00		
<b>TOTAL COST</b>					

**DISTRICT CONTACT**

**NAME:** D3 OPERATIONS TRAFFIC ENGINEER  
**TELEPHONE:** 815 / 434-8446  
**CELL PHONE:**

**SUBMITTED BY:** \_\_\_\_\_

**REGIONAL ENGINEER**

**DATE:** \_\_\_\_\_

MODEL: D:\in\it\p\work\pvmnt\pvmnt.dwg  
FILE NAME: pvmnt.dwg  
PROJECT: D3 HT PVMNT MRKG RPR 25-12  
DRAWN BY: ronald.woodshank  
CHECKED BY: YP  
DATE: 7/28/2023  
SHEET: 15 OF 15

USER NAME = ronald.woodshank	DESIGNED - RW	REVISED -
	DRAWN - RW	REVISED -
PLOT SCALE = \$SCALE\$	CHECKED - YP	REVISED -
PLOT DATE = 9/24/2024	DATE - 7/28/2023	REVISED -

**STATE OF ILLINOIS  
DEPARTMENT OF TRANSPORTATION**

**EXAMPLE WORK ORDER  
"FOR INFORMATION ONLY"**

SCALE: \_\_\_\_\_ SHEET 1 OF 1 SHEETS STA. \_\_\_\_\_ TO STA. \_\_\_\_\_

F.A. RTE.	SECTION	COUNTY	TOTAL SHEETS	SHEET NO.
VAR	D 3 HT PVMNT MRK RPR 25-12	VARIOUS	15	6
			CONTRACT NO. 46655	
		ILLINOIS	FED. AID PROJECT	



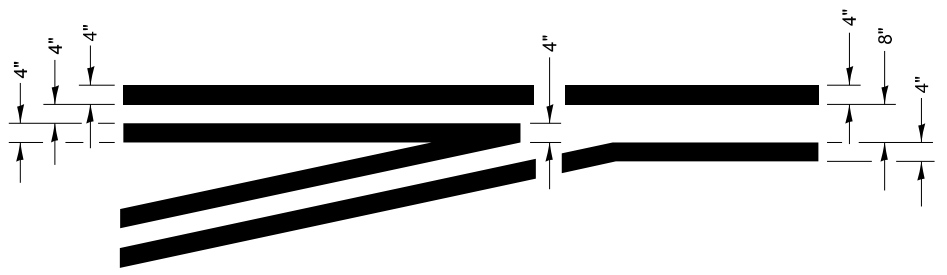

**LEFT TURN LANE  
TYPICAL APPLICATION**

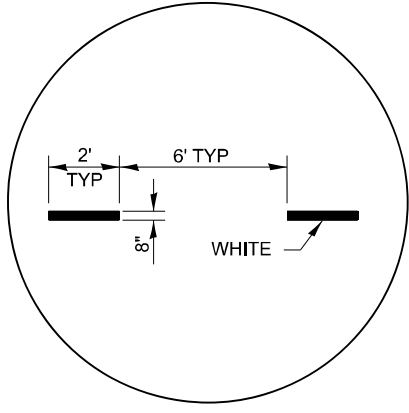

**ADVANCE AND INTERSECTION LANE  
DIVIDER, INTERSTATE RAMP  
TRANSITION LINES**

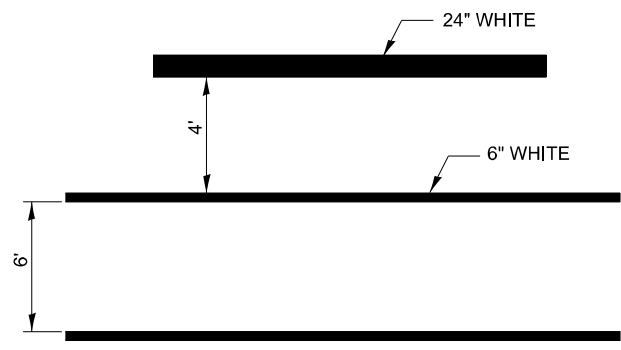

**TYPICAL SPACING DETAIL FOR  
CROSSWALKS AND STOP BARS**

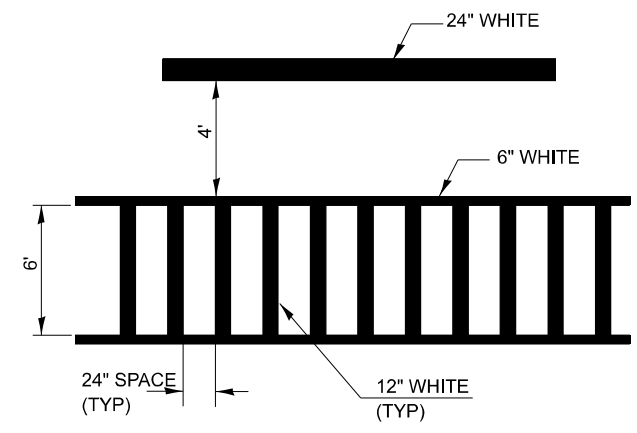

**TYPICAL SPACING DETAIL FOR  
CROSSWALKS AND STOP BARS**

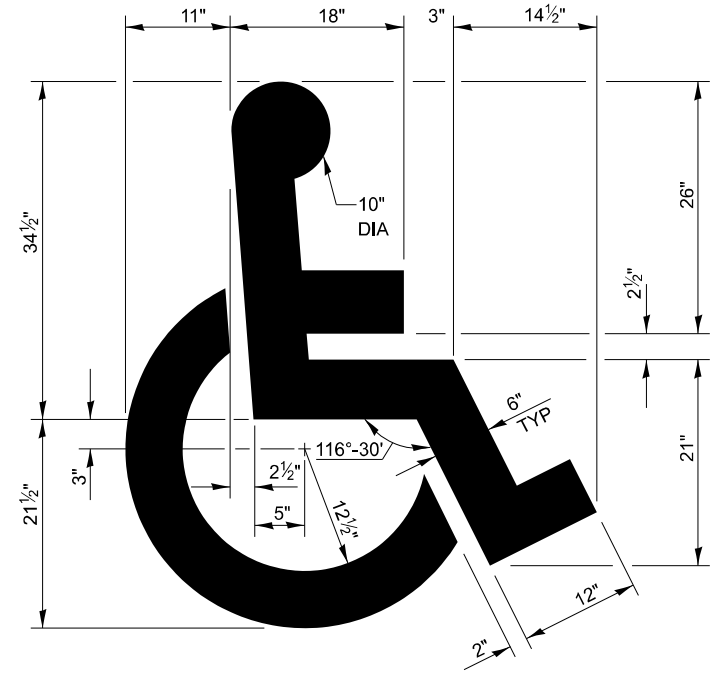

**TYPICAL DETAIL FOR  
PAINTING HANDICAP MARKINGS**

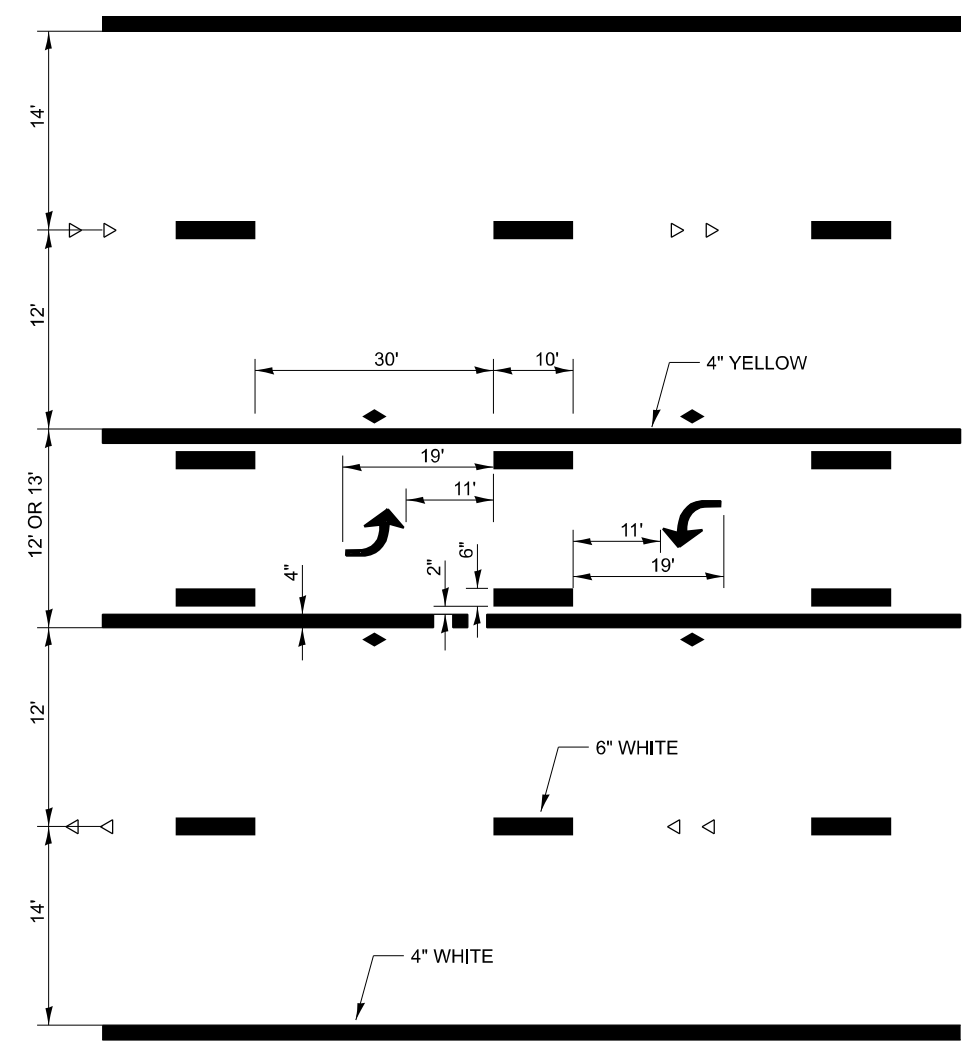

**TYPICAL APPLICATION @  
TWO WAY LEFT TURN LANE (TWLTL)**

MODEL: D:\in\...  
FILE NAME: ...

USER NAME = ronald.woodshank	DESIGNED - RW	REVISED -
DRAWN - RW	CHECKED - YP	REVISED -
PLOT SCALE = \$SCALE\$	DATE - 7/28/2023	REVISED -
PLOT DATE = 9/5/2024		

**STATE OF ILLINOIS  
DEPARTMENT OF TRANSPORTATION**

<b>TYPICAL PAVEMENT MARKING</b>			
SCALE:	SHEET 1	OF 8 SHEETS	STA. TO STA.

F.A. RTE.	SECTION	COUNTY	TOTAL SHEETS	SHEET NO.
VAR	D 3 HT PVMNT MRK RPR 25-12	VARIOUS	15	8
			CONTRACT NO. 46655	
		ILLINOIS FED. AID PROJECT		



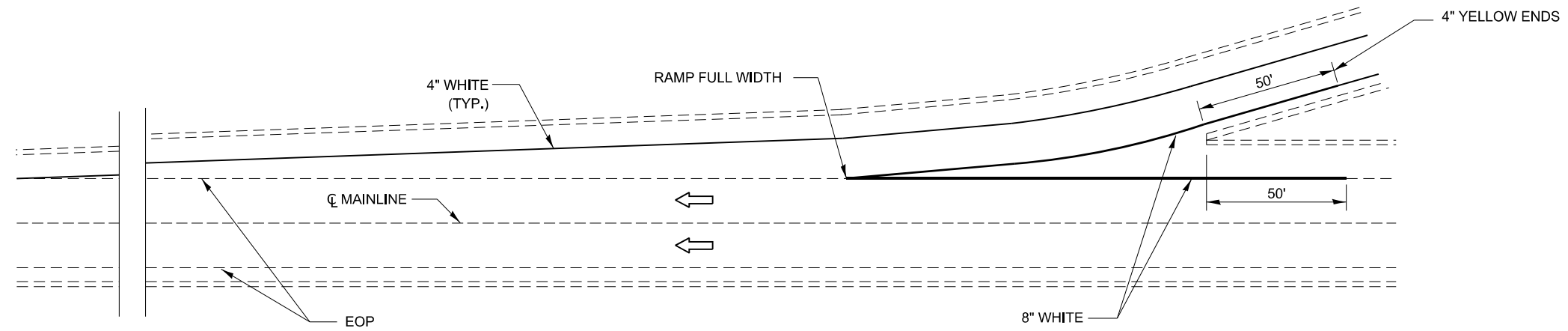

**TYPICAL PAVEMENT MARKING FOR ENTRANCE RAMP TERMINALS**

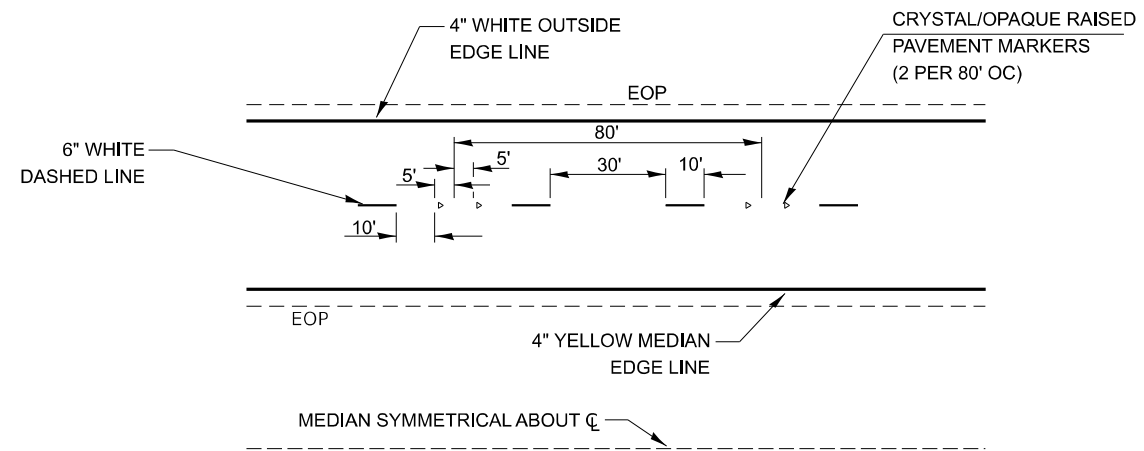

**TYPICAL PAVEMENT MARKINGS**

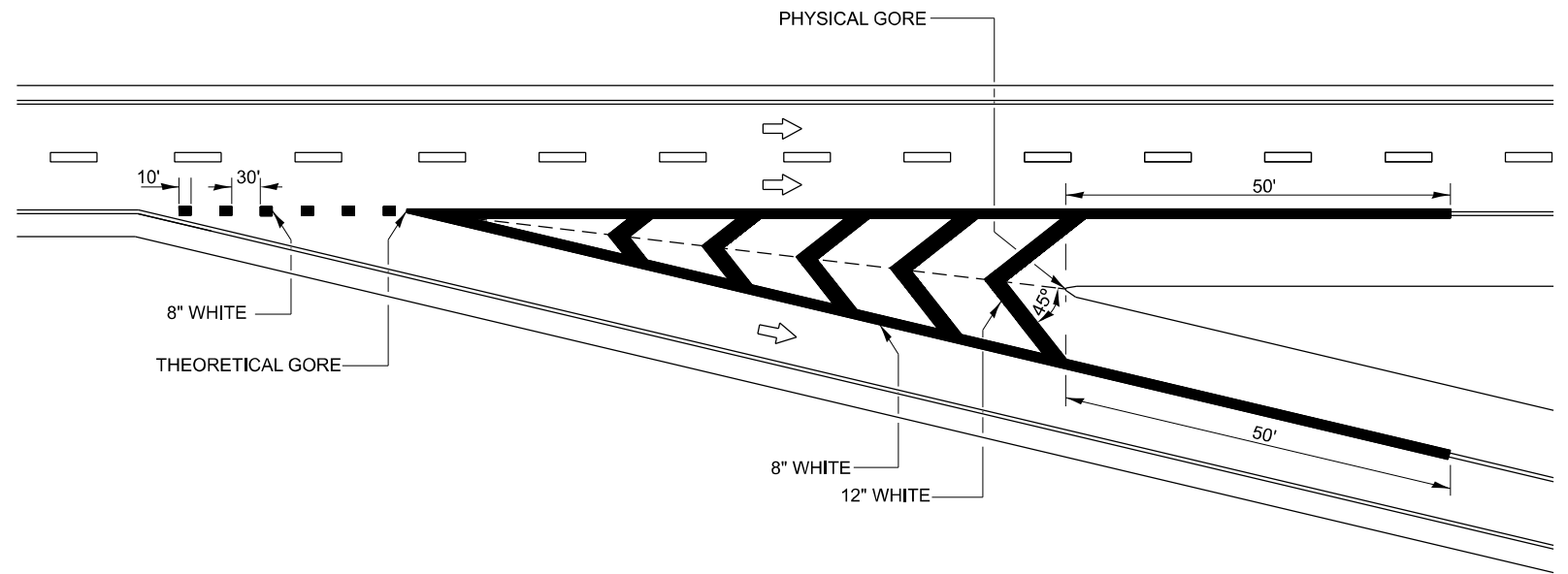

**TYPICAL PAVEMENT MARKING FOR EXIT RAMP TERMINALS**

MODEL: D:\infuit...  
 FILE NAME: ...

USER NAME = ronald.woodshank	DESIGNED - RW	REVISED -
DRAWN - RW	CHECKED - YP	REVISED -
PLOT SCALE = \$SCALE\$	DATE - 7/28/2023	REVISED -
PLOT DATE = 9/21/2024		

**STATE OF ILLINOIS  
 DEPARTMENT OF TRANSPORTATION**

**TYPICAL PAVEMENT MARKING**

SCALE: SHEET 2 OF 8 SHEETS STA. TO STA.

F.A. RTE.	SECTION	COUNTY	TOTAL SHEETS	SHEET NO.
VAR	D 3 HT PVMNT MRK RPR 25-12	VARIOUS	15	9
CONTRACT NO. 46655				
ILLINOIS FED. AID PROJECT				

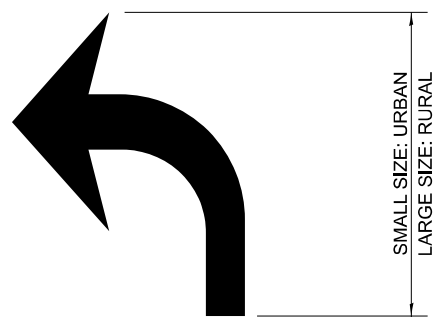

20' (6 M): URBAN  
50' (15 M): RURAL  
(BETWEEN ARROW  
AND WORD OR  
BETWEEN WORDS)

**ONLY**

**WORD AND ARROW LAYOUT**

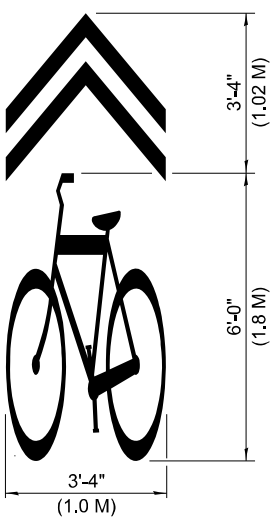

**SHARED LANE SYMBOL**

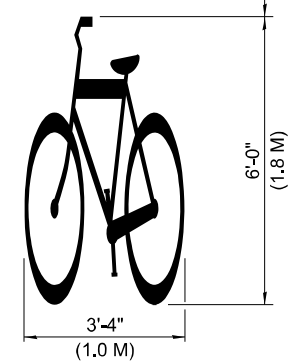
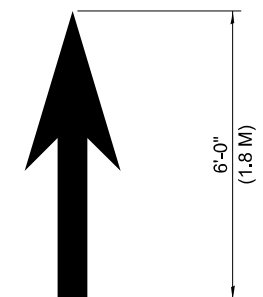

**BIKE SYMBOL**  
(ARROW IS OPTIONAL.)

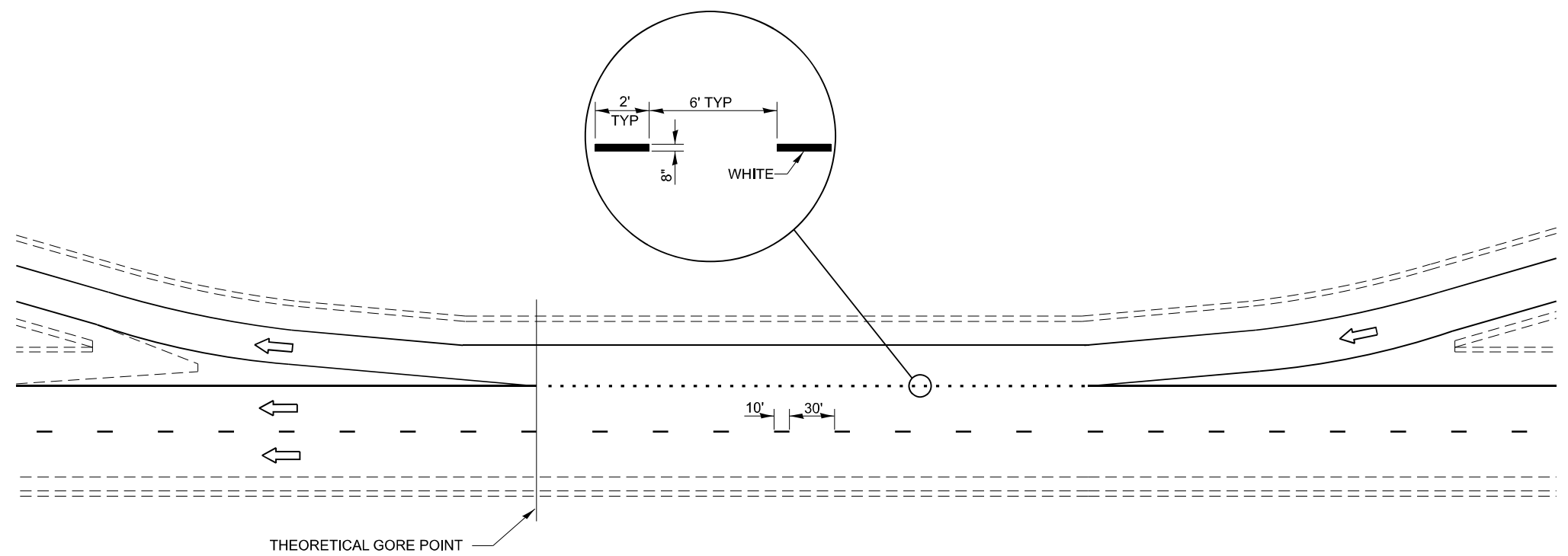

**TYPICAL CLOVERLEAF LOOP RAMP MARKINGS**

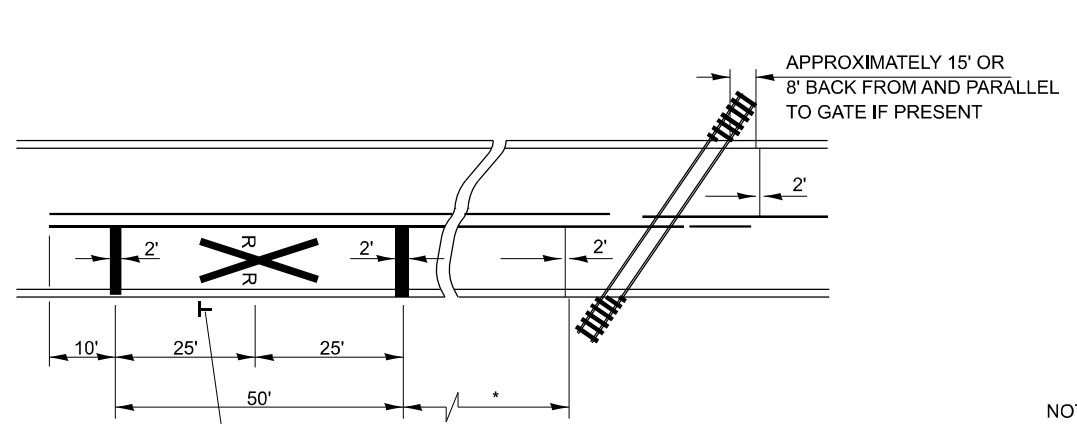

**PAVEMENT MARKINGS AT RAILROAD-HIGHWAY GRADE CROSSING**

\* MINIMUM DISTANCE  
500' FOR 55 MPH  
375' FOR 45 MPH  
250' FOR 35 MPH OR LESS

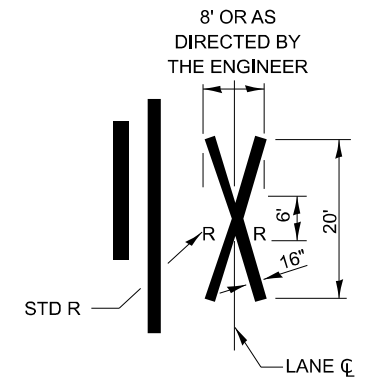

NOTES:  
THE TRANSVERSE SPREAD OF THE "X" MAY VARY ACCORDING TO LANE WIDTH.  
  
ON MULTI-LANE ROADS, THE STOP LINES SHALL EXTEND ACROSS ALL APPROACH LANES AND SEPARATE RXR SYMBOLS SHALL BE PLACED ADJACENT TO EACH OTHER IN EACH LANE.  
  
WHEN THE PAVEMENT MARKING SYMBOL IS USED, A PORTION OF THE SYMBOL SHOULD BE LOCATED DIRECTLY ADJACENT TO THE ADVANCE WARNING SIGN (W10-1).

MODEL: D:\in\it...  
FILE NAME: ...

USER NAME = ronald.woodshank	DESIGNED - RW	REVISED -
DRAWN - RW	REVISED -	
PLOT SCALE = \$SCALE\$	CHECKED - YP	REVISED -
PLOT DATE = 9/5/2024	DATE - 7/28/2023	REVISED -

STATE OF ILLINOIS  
DEPARTMENT OF TRANSPORTATION

TYPICAL PAVEMENT MARKING	
SCALE:	SHEET 3 OF 8 SHEETS STA. TO STA.

F.A. RTE.	SECTION	COUNTY	TOTAL SHEETS	SHEET NO.
VAR	D 3 HT PVMNT MRK RPR 25-12	VARIOUS	15	10
			CONTRACT NO. 46655	
		ILLINOIS FED. AID PROJECT		

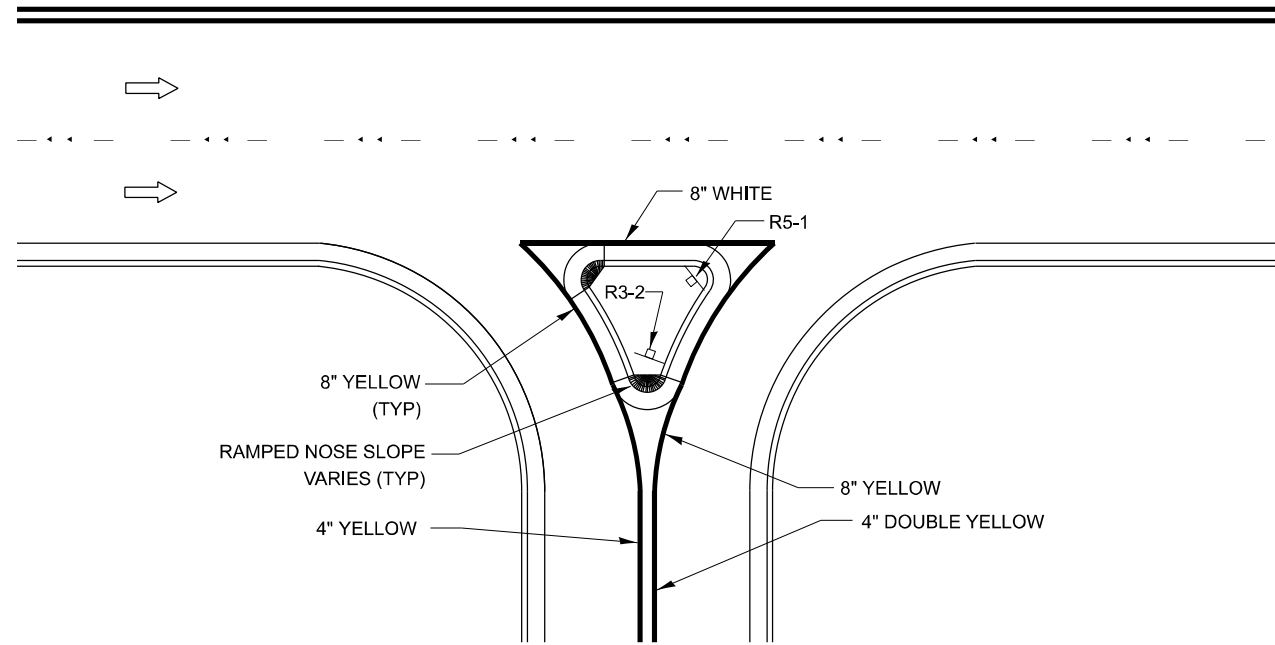

**RIGHT IN RIGHT OUT ACCESS PAVEMENT MARKING**

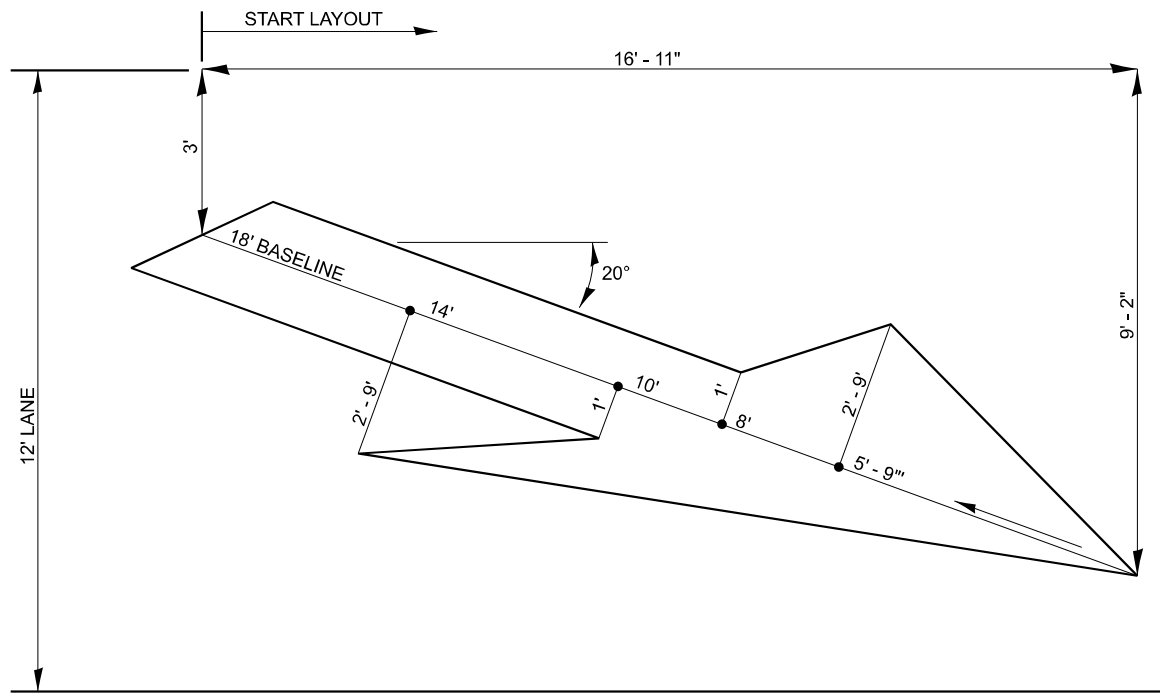

**LARGE MERGE ARROWS**  
**41.5 Sq. Ft.**

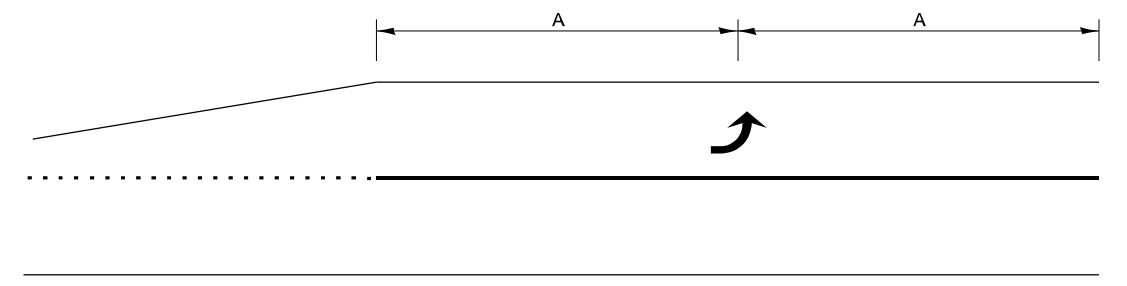

**99' AND UNDER**

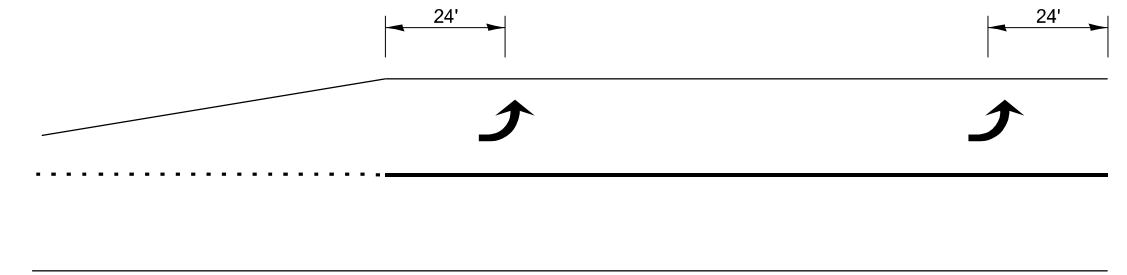

**100' TO 149'**

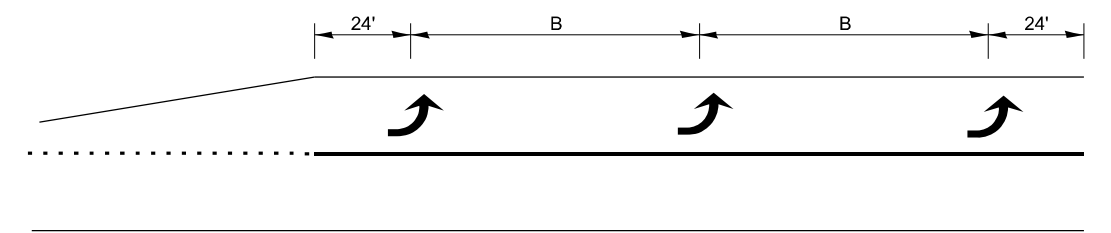

**150' AND LONGER**

**TYPICAL PLACEMENT OF ARROWS**  
**IN TURN LANES**

MODEL: D:\infuit...  
FILE NAME: ...

USER NAME = ronald.woodshank	DESIGNED - RW	REVISED -
DRAWN - RW	CHECKED - YP	REVISED -
PLOT SCALE = \$SCALE\$	DATE - 7/28/2023	REVISED -
PLOT DATE = 9/5/2024		

**STATE OF ILLINOIS**  
**DEPARTMENT OF TRANSPORTATION**

**TYPICAL PAVEMENT MARKING**

SCALE: SHEET 4 OF 8 SHEETS STA. TO STA.

F.A. RTE.	SECTION	COUNTY	TOTAL SHEETS	SHEET NO.
VAR	D 3 HT PVMNT MRK RPR 25-12	VARIOUS	15	11
CONTRACT NO. 46655				
ILLINOIS FED. AID PROJECT				

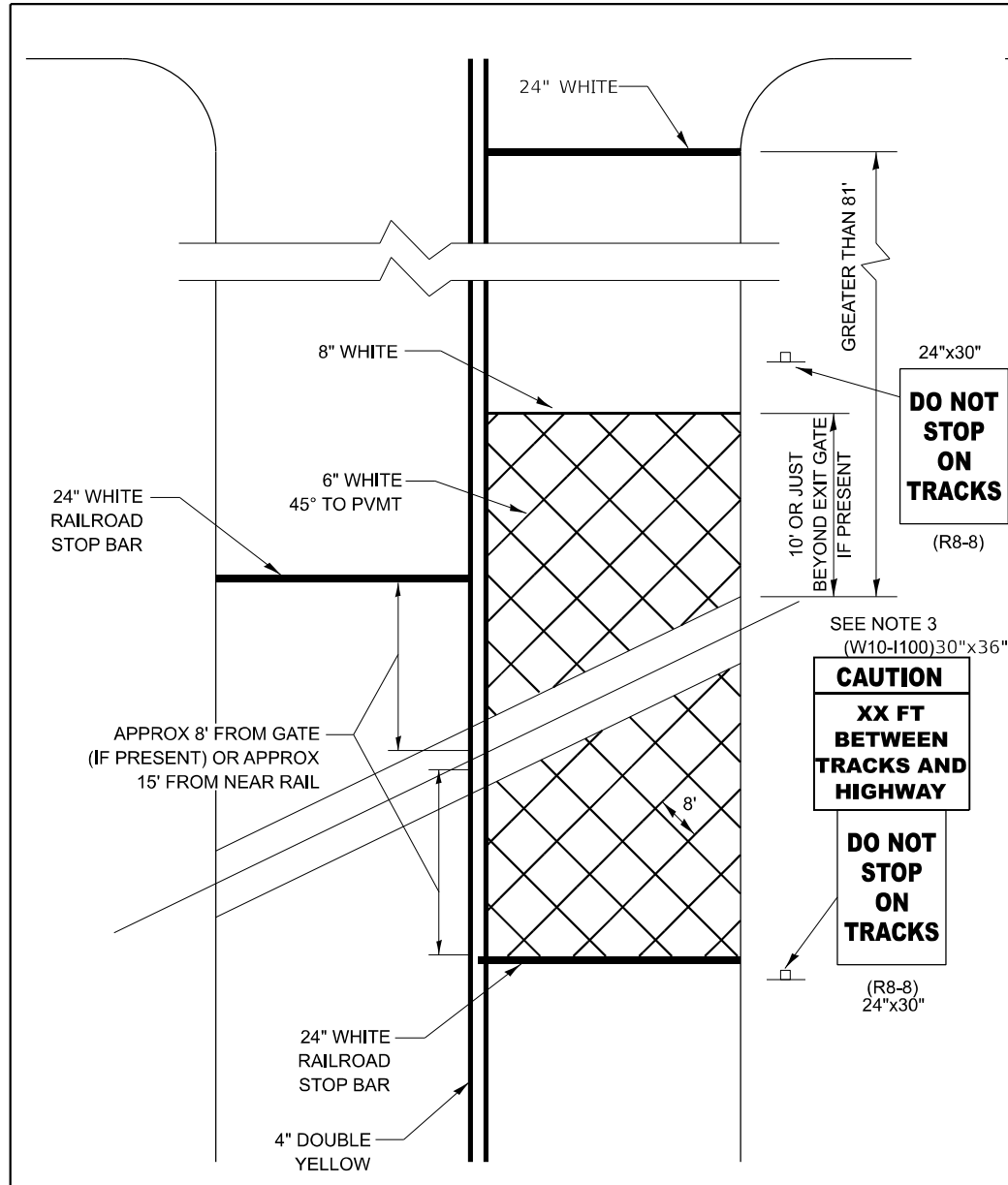

**WITH INTERSECTION TRAFFIC SIGNALS**

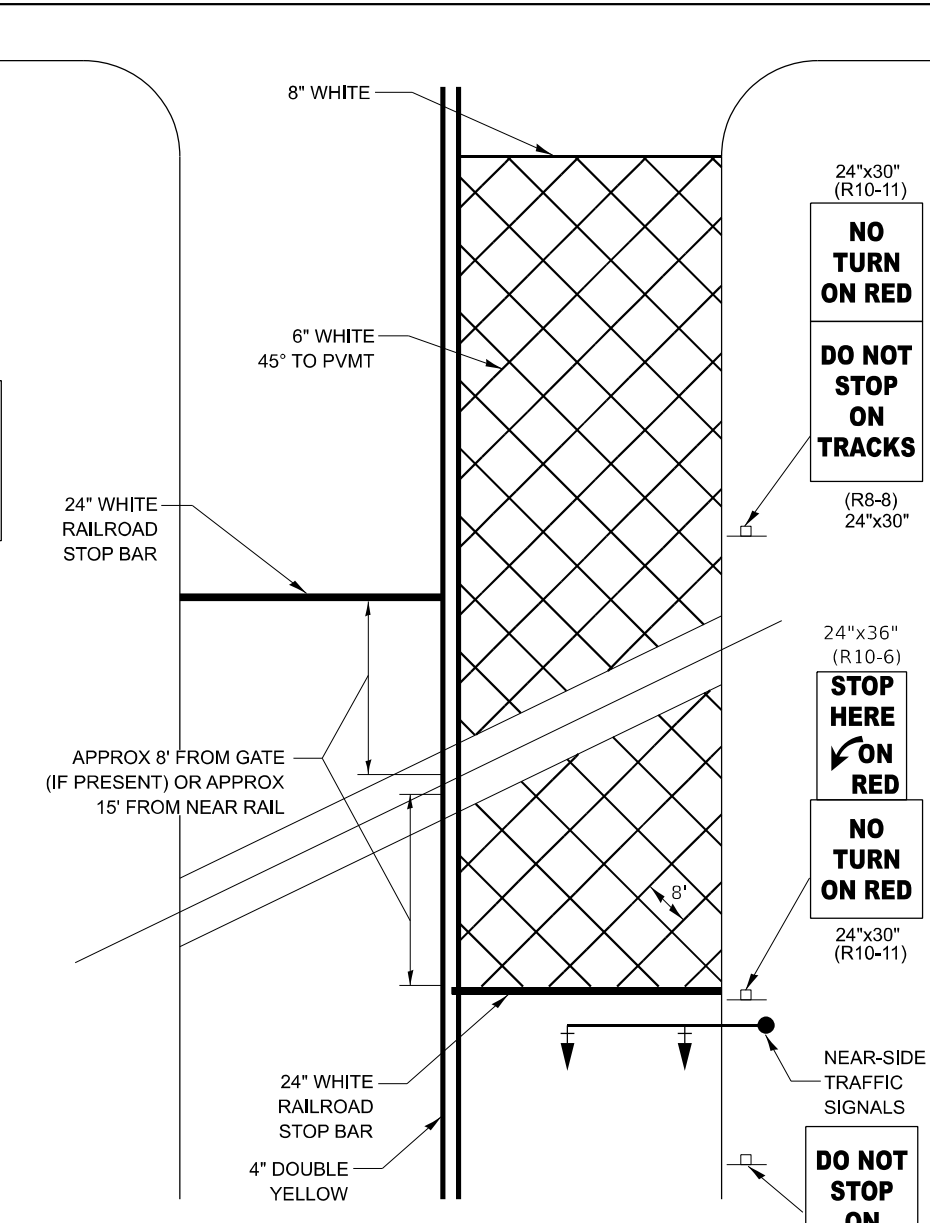

**WITH NEAR-SIDE TRAFFIC SIGNALS**

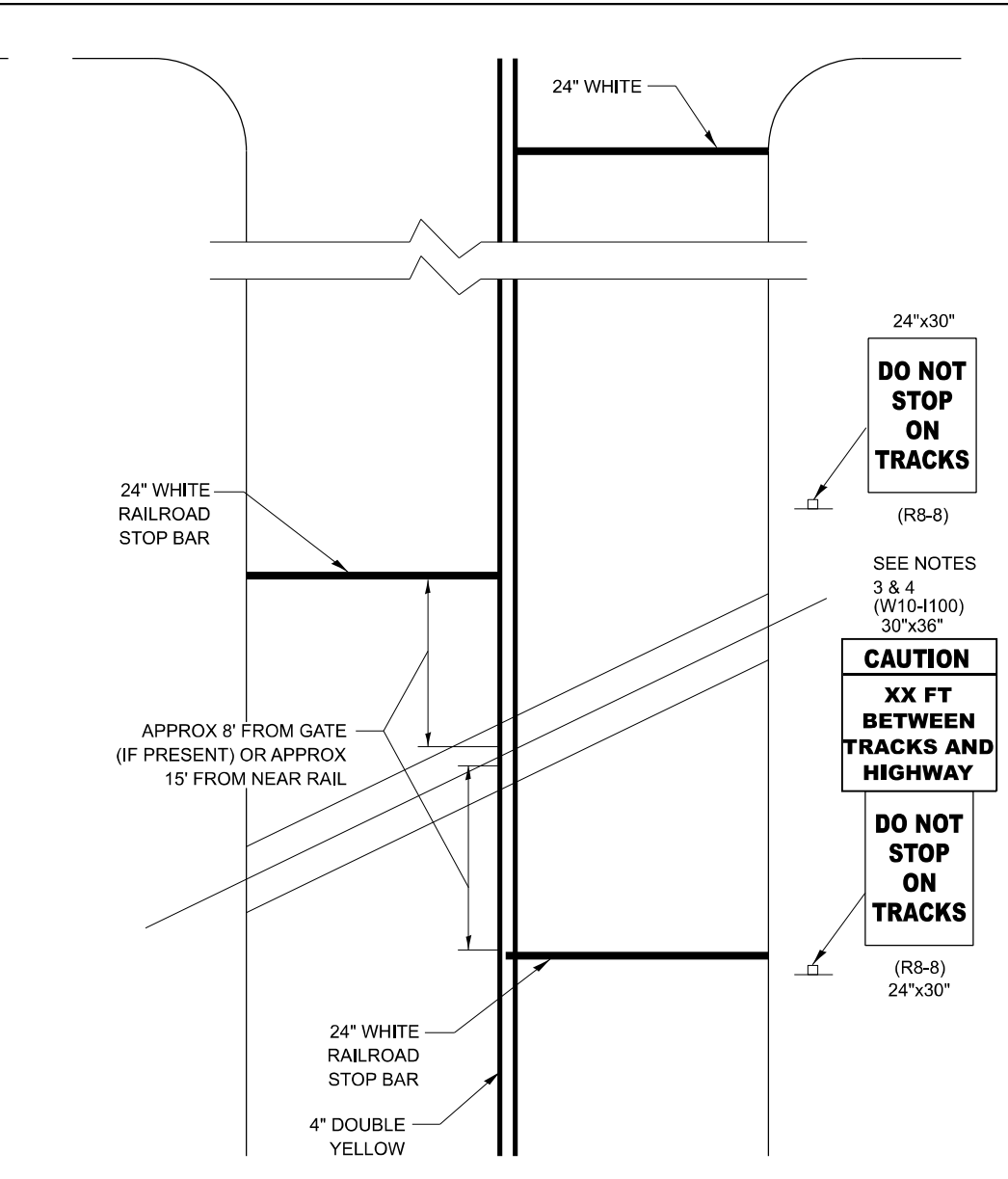

**WITH NONSIGNALIZED INTERSECTION**

- NOTES:
- PAVEMENT MARKINGS TO BE INSTALLED ONLY ON APPROACHES TO INTERSECTIONS CONTROLLED BY TRAFFIC SIGNALS WHICH ARE INTERCONNECTED WITH THE RAILROAD WARNING SIGNALS.
  - WHERE NEAR-SIDE TRAFFIC SIGNALS ARE USED THE PAVEMENT MARKINGS EXTEND TO THE INTERSECTION.
  - DISTANCE TO BE SHOWN ON SIGN MEASURED FROM A POINT 6 FEET FROM THE RAIL CLOSEST TO THE INTERSECTION OR FROM THE CLOSEST POINT ALONG THE EXIT GATE IF PRESENT OVER THE ROADWAY WHEN IN THE LOWERED POSITION TO THE STOP BAR OR CROSSWALK, WHICH EVER IS CLOSEST, ROUNDED DOWN TO NEAREST 5 FEET. WHERE THERE IS NO STOP LINE, MEASURE TO POINT WHERE DRIVER HAS A VIEW OF APPROACHING TRAFFIC.
  - THE CLEARANCE SIGN IS ALSO TO BE USED AS AN INTERIM MEASURE AT LOCATIONS WITH INTERCONNECTED INTERSECTION TRAFFIC SIGNALS WHERE IT IS PLANNED TO CHANGE THEM TO NEAR-SIDE SIGNALS AT A FUTURE TIME. IN THIS CASE, THE DISTANCE TO BE SHOWN ON THE SIGN IS MEASURED FROM THE EDGE OF THE STRIPED-OUT AREA INSTEAD OF 6 FEET FROM THE RAIL. THE SIGN IS TO BE REMOVED WHEN THE NEAR-SIDE SIGNALS ARE INSTALLED AND THE PAVEMENT MARKINGS EXTEND TO THE INTERSECTION.

MODEL: D:\rail\...  
 FILE NAME: ...  
 PROJECT: ...  
 SHEETS: 46655.dgn

USER NAME = ronald.woodshank	DESIGNED - RW	REVISED -	<b>STATE OF ILLINOIS DEPARTMENT OF TRANSPORTATION</b>	<b>TYPICAL PAVEMENT MARKING</b>			F.A. RTE.	SECTION	COUNTY	TOTAL SHEETS	SHEET NO.
DRAWN - RW	CHECKED - YP	REVISED -					VAR	D 3 HT PVMNT MRK RPR 25-12	VARIOUS	15	12
PLOT SCALE = \$SCALE\$	DATE - 7/28/2023	REVISED -		SCALE: SHEET 5 OF 8 SHEETS STA. TO STA.			CONTRACT NO. 46655				
PLOT DATE = 9/5/2024							ILLINOIS FED. AID PROJECT				

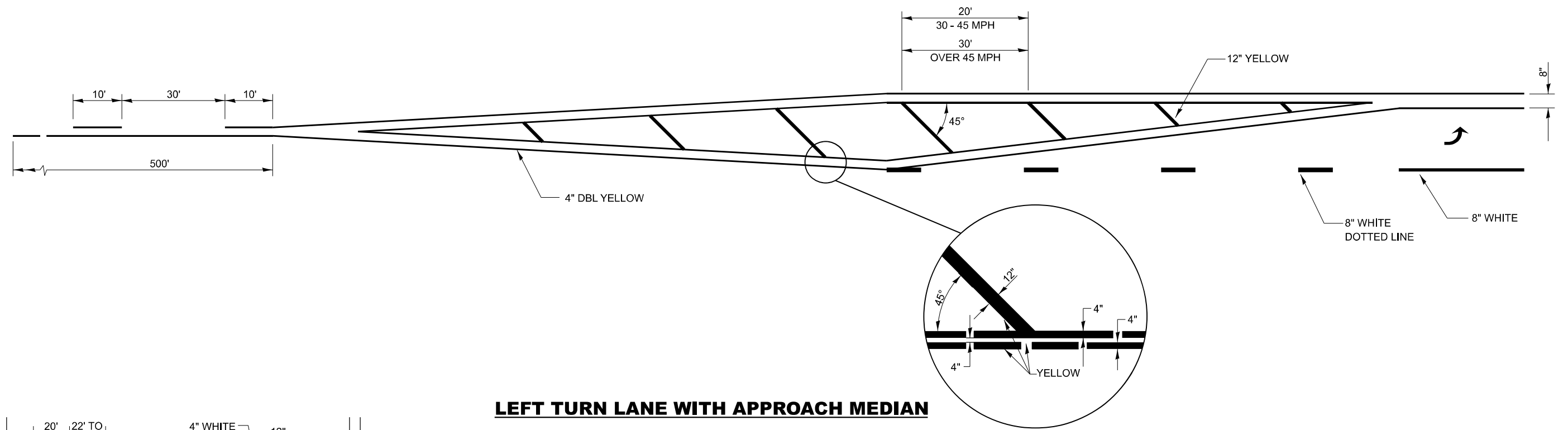

**LEFT TURN LANE WITH APPROACH MEDIAN**

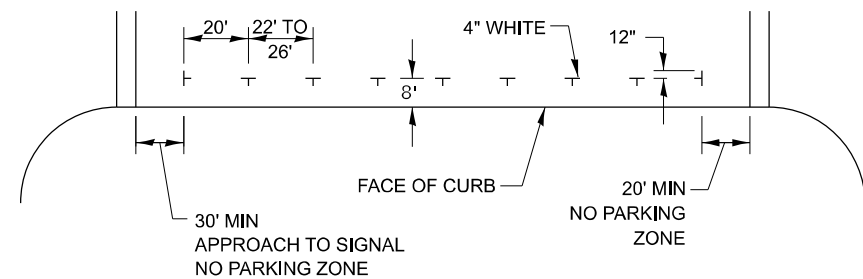

**PREFERRED METHOD**

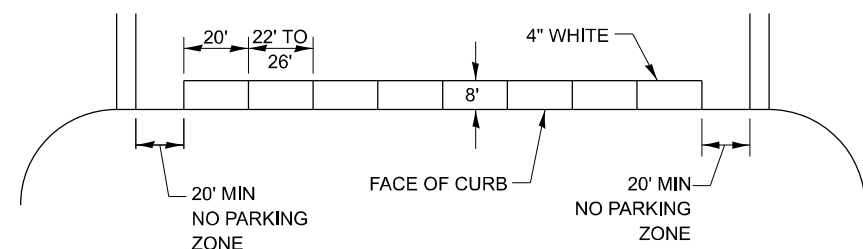

**OPTION 2**

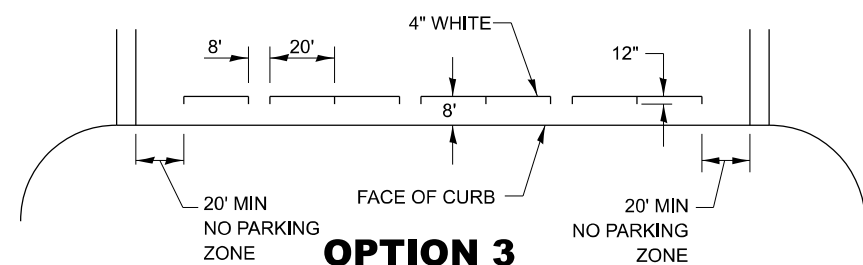

**OPTION 3**

**TYPICAL PARKING SPACING**

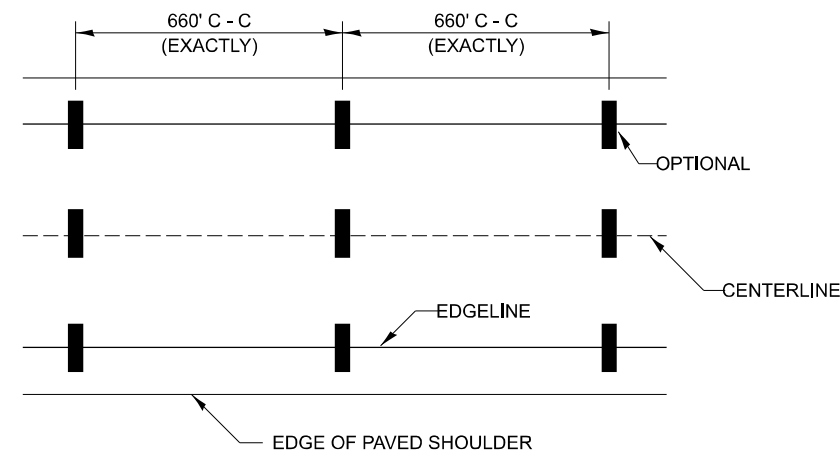

IT WILL BE NECESSARY TO HAVE A REPRESENTATIVE OF THE STATE POLICE PRESENT SO THAT THE ACCURACY OF MEASUREMENT CAN BE ATTESTED TO IN COURT.

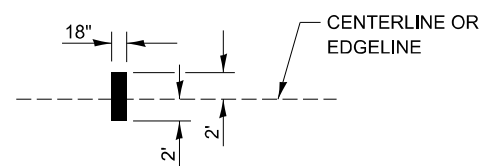

**AERIAL SPEED CHECK ZONES**

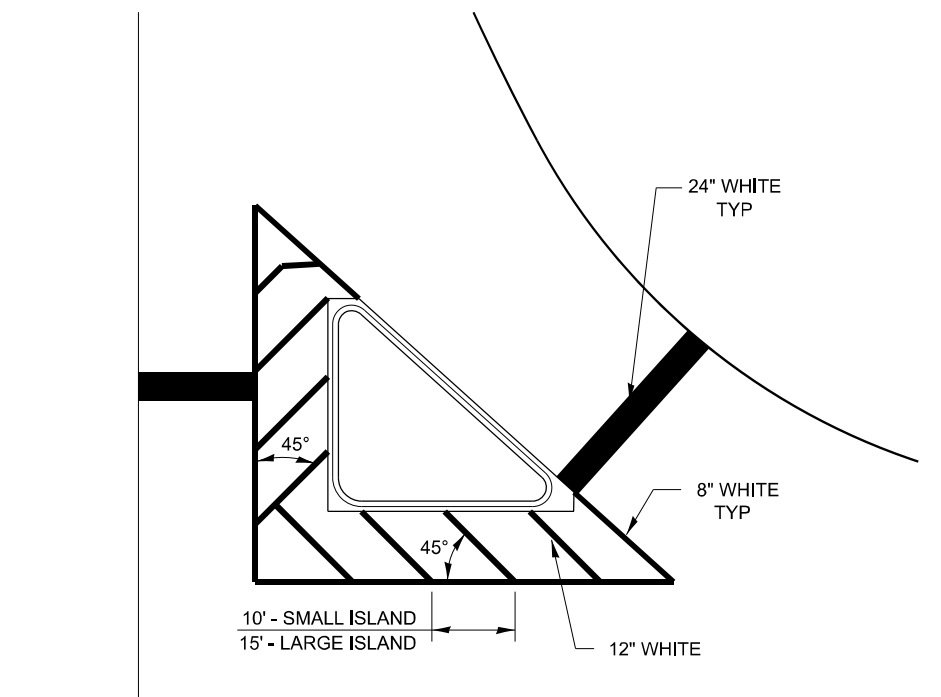

**TYPICAL ISLAND**

MODEL: D:\in\... FILE NAME: ...

USER NAME = ronald.woodshank	DESIGNED - RW	REVISED -
DRAWN - RW	REVISOR -	
PLOT SCALE = \$SCALE\$	CHECKED - YP	REVISED -
PLOT DATE = 9/5/2024	DATE - 7/28/2023	REVISED -

**STATE OF ILLINOIS  
DEPARTMENT OF TRANSPORTATION**

**TYPICAL PAVEMENT MARKING**

SCALE: SHEET 6 OF 8 SHEETS STA. TO STA.

F.A. RTE.	SECTION	COUNTY	TOTAL SHEETS	SHEET NO.
VAR	D 3 HT PVMNT MRK RPR 25-12	VARIOUS	15	13
			CONTRACT NO. 46655	
		ILLINOIS FED. AID PROJECT		

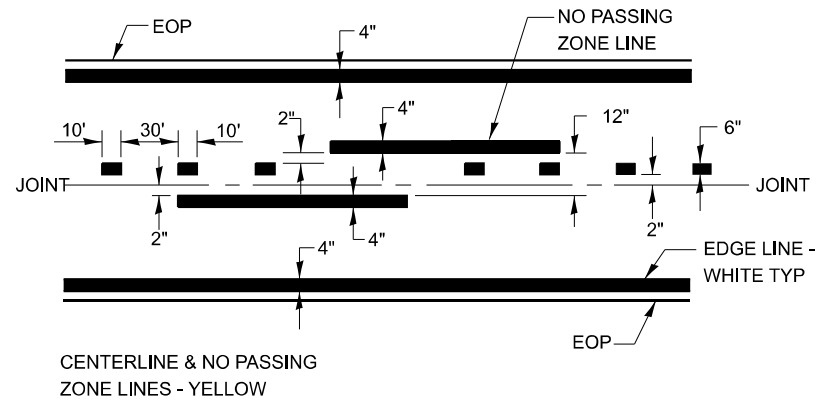

CENTERLINE & NO PASSING ZONE LINES - YELLOW

**2 LANE**

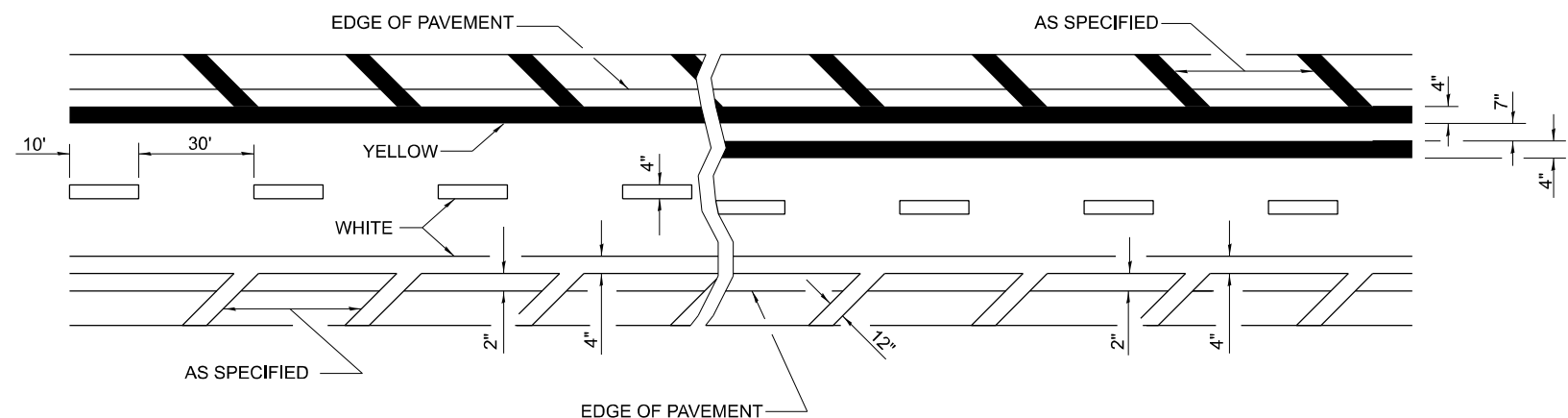

**DIVIDED**

**MULTI LANE**

**UNDIVIDED**

**LANE AND EDGE LINES**

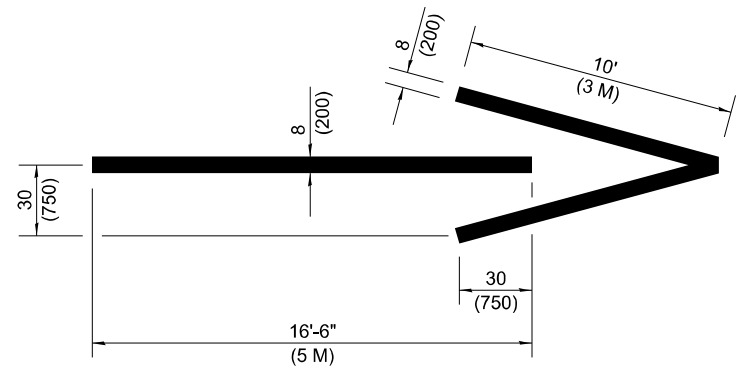

**WRONG WAY ARROW**

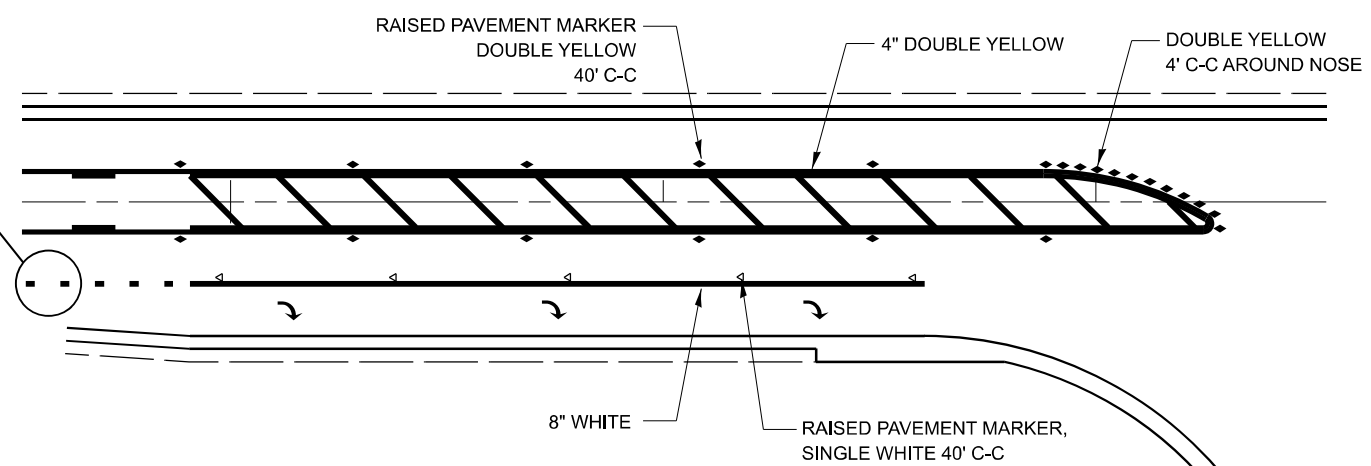
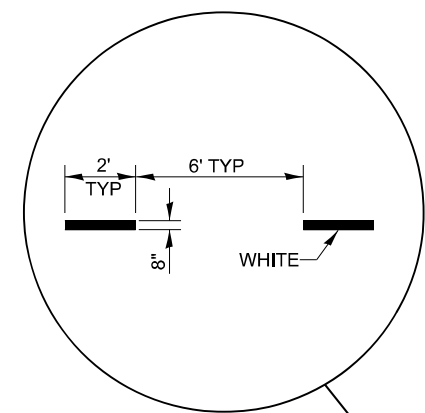

**RAISED REFLECTIVE AND PAVEMENT MARKERS @ RIGHT TURN LANE**

MODEL: D:\inf\... FILE NAME: ...

USER NAME = ronald.woodshank	DESIGNED - RW	REVISED -
DRAWN - RW	REVISOR -	
PLOT SCALE = \$SCALE\$	CHECKED - YP	REVISED -
PLOT DATE = 9/5/2024	DATE - 7/28/2023	REVISED -

**STATE OF ILLINOIS  
DEPARTMENT OF TRANSPORTATION**

**TYPICAL PAVEMENT MARKING**

SCALE: SHEET 7 OF 8 SHEETS STA. TO STA.

F.A. RTE.	SECTION	COUNTY	TOTAL SHEETS	SHEET NO.
VAR	D 3 HT PVMNT MRK RPR 25-12	VARIOUS	15	14
CONTRACT NO. 46655				
ILLINOIS FED. AID PROJECT				

MODEL: D:\in\it...  
 FILE NAME: ...  
 PROJECT: ...  
 SHEETS: 46655.dgn

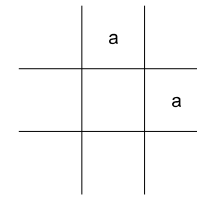
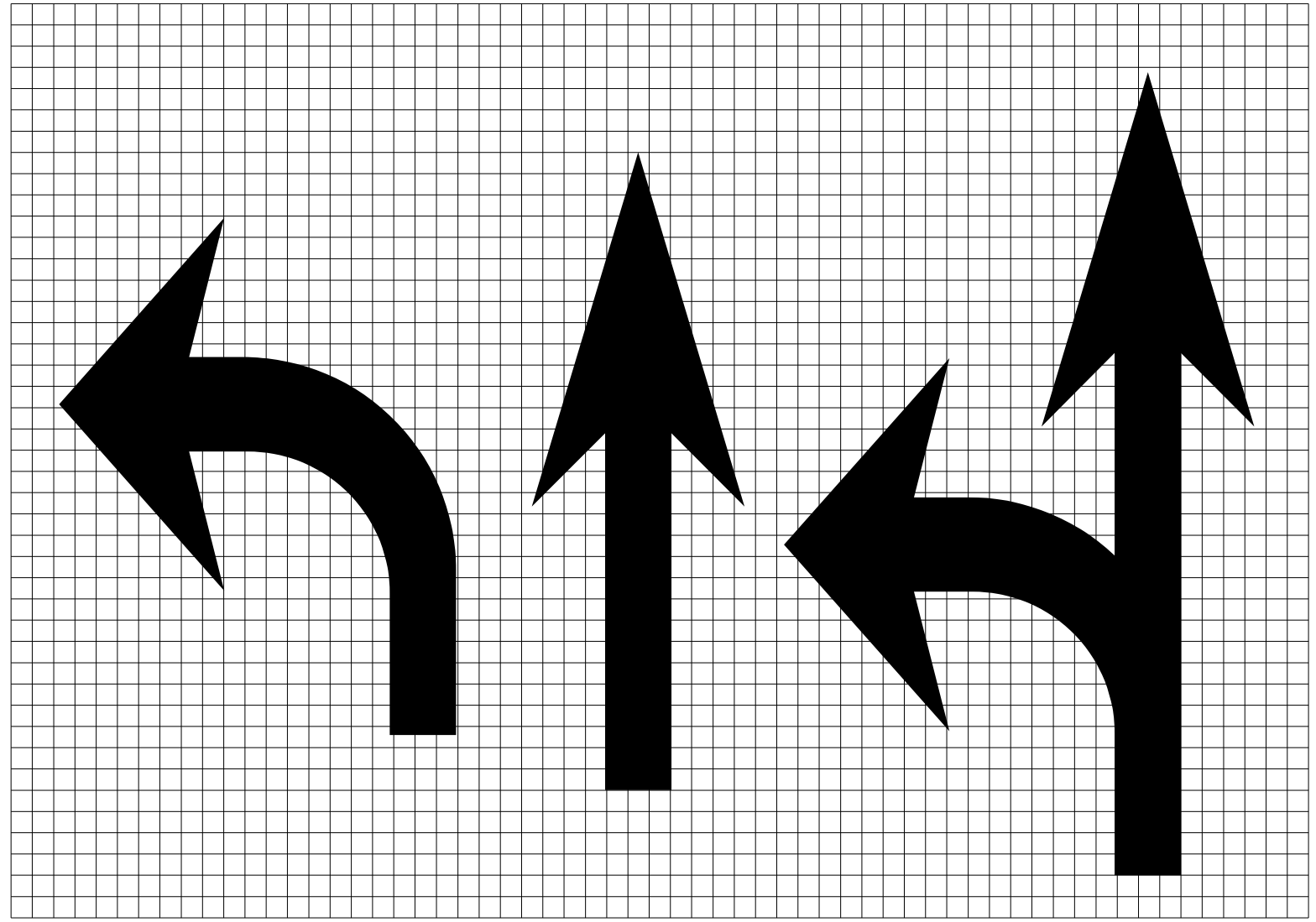

LEGEND HEIGHT	ARROW SIZE	a
6' (1.8 M)	SMALL	2.9 (74)
8' (2.4 M)	LARGE	3.8 (96)

THE SPACE BETWEEN ADJACENT LETTERS OR NUMERALS SHOULD BE APPROXIMATELY 3 (75) FOR 6' (1.8 M) LEGEND AND 4 (100) FOR 8' (2.4 M) LEGEND.

**LETTER AND ARROW GRID SCALE**

USER NAME = ronald.woodshank	DESIGNED - RW	REVISED -
	DRAWN - RW	REVISED -
PLOT SCALE = \$SCALE\$	CHECKED - YP	REVISED -
PLOT DATE = 9/5/2024	DATE - 7/28/2023	REVISED -

**STATE OF ILLINOIS  
 DEPARTMENT OF TRANSPORTATION**

**TYPICAL PAVEMENT MARKING**

SCALE: SHEET 8 OF 8 SHEETS STA. TO STA.

F.A. RTE.	SECTION	COUNTY	TOTAL SHEETS	SHEET NO.
VAR	D 3 HT PVMNT MRK RPR 25-12	VARIOUS	15	15
			CONTRACT NO. 46655	
ILLINOIS FED. AID PROJECT				