

F.A.I. 24	3B-1-3	MASSAC	11	9	5 SHEETS
FED. ROAD DIST. NO. 7		ILLINOIS	FED. RD. PROJECT		

STATE OF ILLINOIS
 DEPARTMENT OF TRANSPORTATION

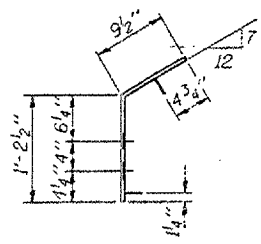
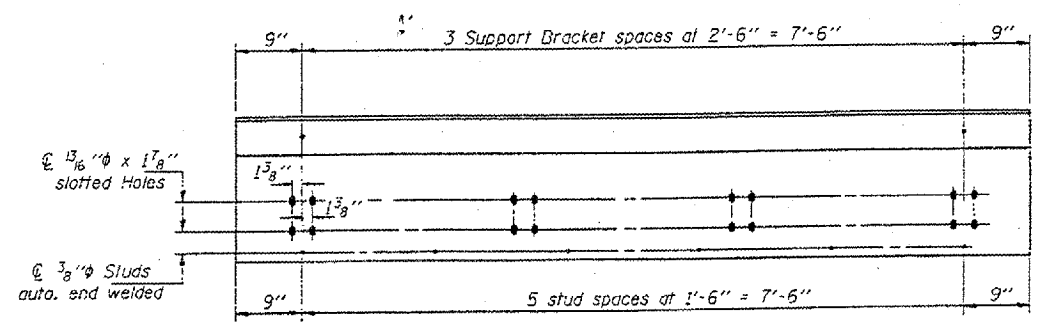

PLATE A

Pl. 5/16" x 2'-0" x 9'-0" long
 (At Piers 3, 8 & 12)
 Number Req'd: 18 Total

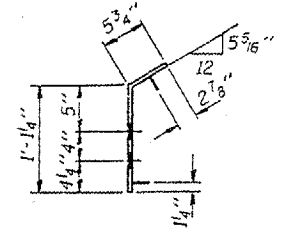
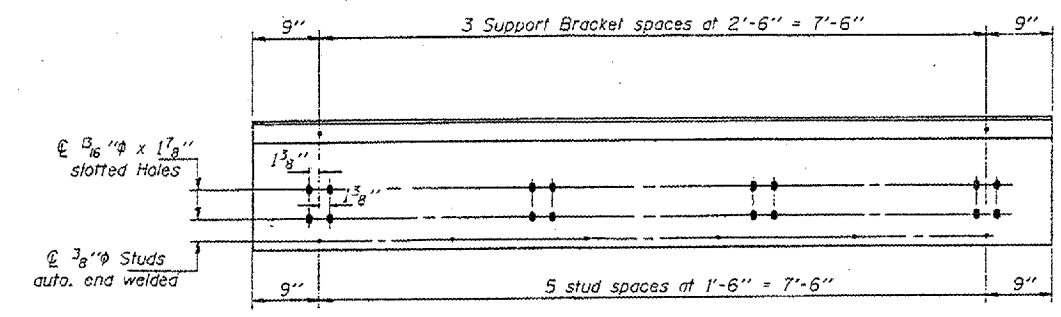

PLATE C

Pl. 5/16" x 1'-7" x 9'-0" long
 (At Piers 3, 8 & 12)
 Number Req'd: 18 Total

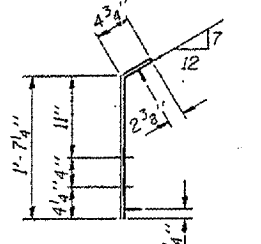
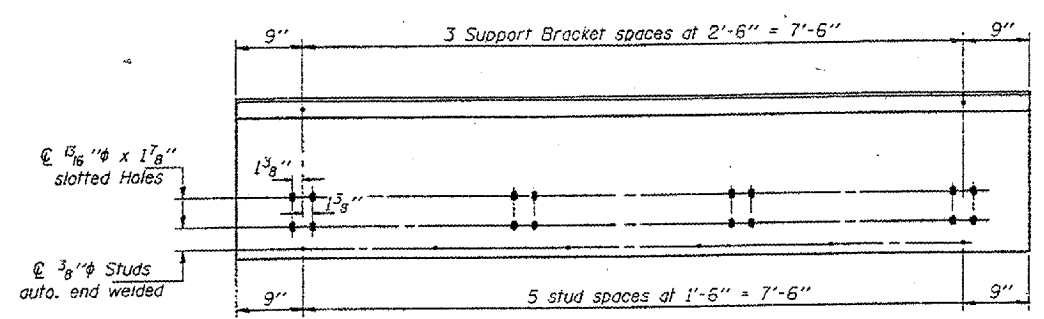

PLATE B

Pl. 5/16" x 2'-0" x 9'-0" long
 (At Piers 4 & 13)
 Number Req'd: 12 Total

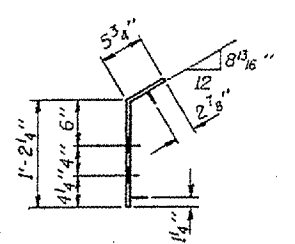
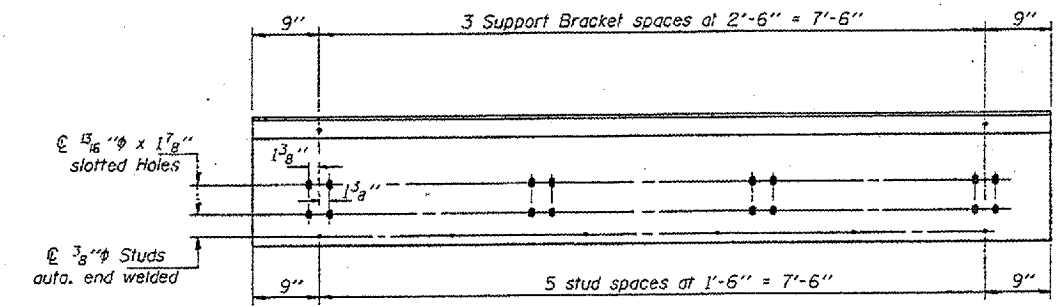
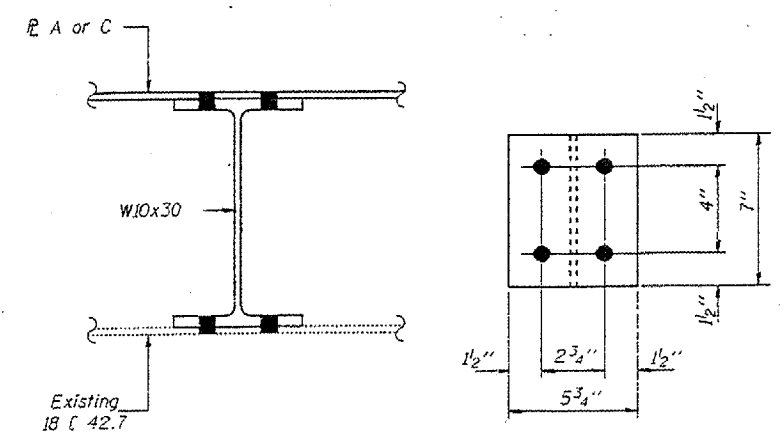
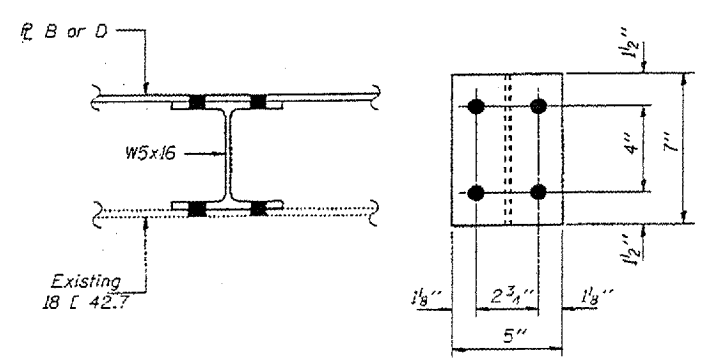

PLATE D

Pl. 5/16" x 1'-8" x 9'-0" long
 (At Piers 4 & 13)
 Number Req'd: 12 Total



SUPPORT BRACKET
W10X30
 (At Piers 3, 8 & 12)
 Number Req'd: 144 Total



SUPPORT BRACKET
W5X16
 (At Piers 4 & 13)
 Number Req'd: 96 Total

DESIGNED	KPS	FEBRUARY 29	1996
CHECKED	NJS	EXAMINED	<i>Scott E. Adams</i>
DRAWN	DHerbert	PASSED	
CHECKED	NJS KPS	ENGINEER OF BRIDGES AND STRUCTURES	

BRIDGE REPAIRS
F.A.I. 24 OVER OHIO RIVER
SEC. 64-3B-I-3
MASSAC COUNTY
S.N. 064-0035