

F.A.P. RTE.	SECTION	COUNTY	TOTAL SHEETS	SHEET NO.
322	11-13	CHRISTIAN	437	146
STA.		TO STA.		
FED. ROAD DIST. NO.		ILLINOIS FED. AID PROJECT		

POINT	FAP 322 (US 51)		TR 243		ELEVATION
	STATION	OFFSET	STATION	OFFSET	
A1	521+48.13	109.53 LT	18+90.33	12.00 RT	651.82
A2	521+46.88	97.84 LT	19+02.01	13.38 RT	652.02
A3	521+42.92	86.77 LT	19+13.04	17.46 RT	652.22
A4	521+36.49	76.92 LT	19+22.82	23.99 RT	652.42
A5	521+27.94	68.85 LT	19+30.80	32.63 RT	652.62
A6	521+17.73	63.00 LT	19+36.54	42.90 RT	652.76
A7	521+04.56	58.00 LT	19+41.39	56.13 RT	652.84
A8	520+91.02	54.08 LT	19+45.17	69.70 RT	652.89
A9	520+77.22	51.27 LT	19+47.84	83.54 RT	652.92
A10	520+63.23	49.57 LT	19+49.39	97.54 RT	652.92
A11	520+49.15	49.00 LT	19+49.80	111.63 RT	652.90

POINT	FAP 322 (US 51)		TR 243		ELEVATION
	STATION	OFFSET	STATION	OFFSET	
E1	520+80.59	13.00 RT	20+12.14	80.85 RT	652.73
E2	521+15.57	4.95 RT	20+04.46	45.79 RT	652.81
E3	521+16.41	8.97 LT	19+90.56	44.79 RT	652.86
E4	520+62.10	25.00 LT	19+73.94	98.93 RT	652.93
E5	522+42.03	13.00 LT	19+87.86	80.85 LT	653.01
E6	522+07.04	4.95 LT	19+95.54	45.79 LT	652.97
E7	522+06.20	8.97 RT	20+09.44	44.79 LT	653.02
E8	522+60.51	25.00 RT	20+26.06	98.93 LT	653.28
E9	521+61.04	25.00 LT	19+75.00	0	653.13
E10	521+61.57	25.00 RT	20+25.00	0	653.13

STATION	OFFSET	ELEVATION	OFFSET	ELEVATION
18+90.33	0.00 RT	652.00	12.00 RT	651.82
19+00.00	0.00 RT	652.15	12.00 RT	652.00
19+25.00	0.00 RT	652.61	12.00 RT	652.54
19+38.87	0.00 RT	652.89	12.00 RT	652.86

POINT	FAP 322 (US 51)		TR 243		ELEVATION
	STATION	OFFSET	STATION	OFFSET	
B1	522+49.96	61.00 LT	19+39.95	89.31 LT	653.08
B2	522+33.50	63.12 LT	19+37.65	72.86 LT	652.94
B3	522+18.11	69.34 LT	19+31.27	57.54 LT	652.75
B4	522+04.79	79.26 LT	19+21.21	44.33 LT	652.41
B5	521+94.43	92.23 LT	19+08.13	34.10 LT	651.99
B6	521+87.68	107.40 LT	18+92.89	27.52 LT	651.65
B7	521+81.89	129.00 LT	18+71.23	21.96 LT	651.35
B8	521+77.31	150.88 LT	18+49.30	17.61 LT	651.21
B9	521+73.96	172.98 LT	18+27.16	14.50 LT	651.11
B10	521+71.85	195.24 LT	18+04.88	12.63 LT	651.05
B11	521+70.98	217.58 LT	17+82.54	12.00 LT	651.03

STATION	OFFSET	ELEVATION	OFFSET	ELEVATION
18+90.33	0.00 RT	652.00	12.00 LT	651.82
19+00.00	0.00 RT	652.15	12.00 LT	652.01
19+25.00	0.00 RT	652.61	12.00 LT	652.57
19+39.12	0.00 RT	652.89	12.00 LT	652.91

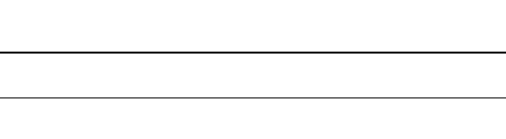
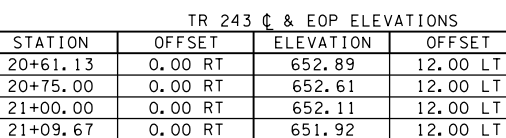
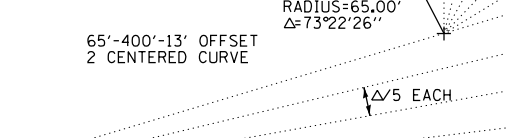
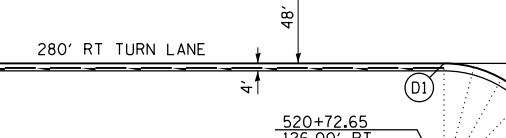
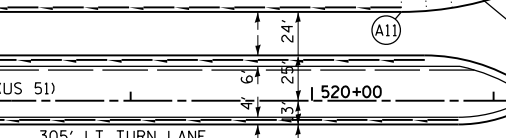
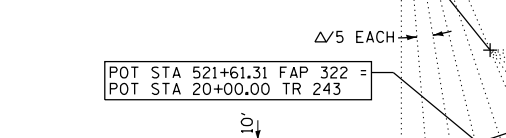
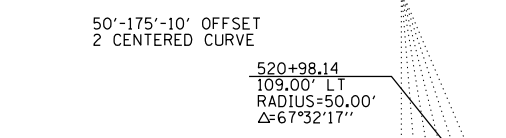
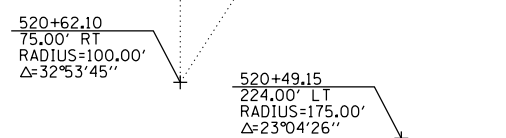
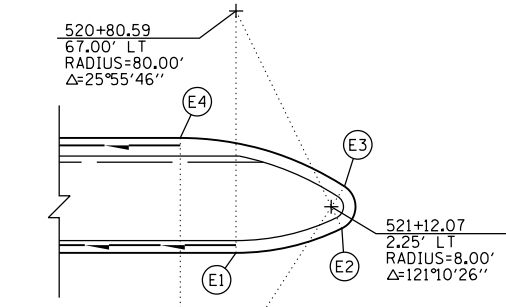

STATION	OFFSET	ELEVATION	OFFSET	ELEVATION
20+61.13	0.00 RT	652.89	12.00 LT	652.91
20+75.00	0.00 RT	652.61	12.00 LT	652.57
21+00.00	0.00 RT	652.11	12.00 LT	651.97
21+09.67	0.00 RT	651.92	12.00 LT	651.74

POINT	FAP 322 (US 51)		TR 243		ELEVATION
	STATION	OFFSET	STATION	OFFSET	
C1	521+74.48	109.53 RT	21+09.67	12.00 LT	651.74
C2	521+75.73	97.84 RT	20+97.99	13.38 LT	651.98
C3	521+79.69	86.77 RT	20+86.96	17.46 LT	652.17
C4	521+86.12	76.92 RT	20+77.18	23.99 LT	652.39
C5	521+94.68	68.85 RT	20+69.20	32.63 LT	652.69
C6	522+04.88	63.00 RT	20+63.46	42.90 LT	652.91
C7	522+18.05	58.00 RT	20+58.61	56.13 LT	653.04
C8	522+31.59	54.08 RT	20+54.83	69.70 LT	653.13
C9	522+45.40	51.27 RT	20+52.16	83.54 LT	653.21
C10	522+59.38	49.57 RT	20+50.61	97.54 LT	653.26
C11	522+73.46	49.00 RT	20+50.20	111.63 LT	653.29

POINT	FAP 322 (US 51)		TR 243		ELEVATION
	STATION	OFFSET	STATION	OFFSET	
D1	520+72.65	61.00 RT	20+60.05	89.31 RT	652.71
D2	520+89.11	63.12 RT	20+62.35	72.86 RT	652.70
D3	521+04.51	69.34 RT	20+68.73	57.54 RT	652.58
D4	521+17.82	79.26 RT	20+78.79	44.33 RT	652.32
D5	521+28.19	92.23 RT	20+91.87	34.10 RT	651.94
D6	521+34.93	107.40 RT	21+07.11	27.52 RT	651.59
D7	521+40.72	128.99 RT	21+28.77	21.96 RT	651.17
D8	521+45.30	150.88 RT	21+50.70	17.61 RT	650.81
D9	521+48.66	172.98 RT	21+72.84	14.50 RT	650.47
D10	521+50.77	195.24 RT	21+95.12	12.63 RT	650.15
D11	521+51.63	217.58 RT	22+17.46	12.00 RT	649.85

NOTES:
ALL STATIONS, OFFSETS, AND ELEVATIONS SHOWN ARE FOR FINAL PAVING.
SEE SHEETS 105 & 118 FOR PLAN AND PROFILES.

REVISIONS	
NAME	DATE

ILLINOIS DEPARTMENT OF TRANSPORTATION
GEOMETRIC DETAILS
TR 243
FAP 322 (US 51)
SECTION 11-13
CHRISTIAN COUNTY

SCALE: DATE 7/12

DRAWN BY: CHECKED BY:

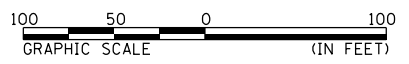

10/5/2012
D:\01\105\01032\F\PLANS_NEW\CAD - Sheets\05\2\051-shl\geom\trc_data\105_TR243.dgn