

*REF-
*REF-
*REF-

F.A.P. RTE.	SECTION	COUNTY	TOTAL SHEETS	SHEET NO.
342	(G&I2) 1-N-1	LAKE	70	39
STA.		TO STA.		
FED. ROAD DIST. NO. 1		ILLINOIS FED. AID PROJECT		

CONTRACT #: 62883

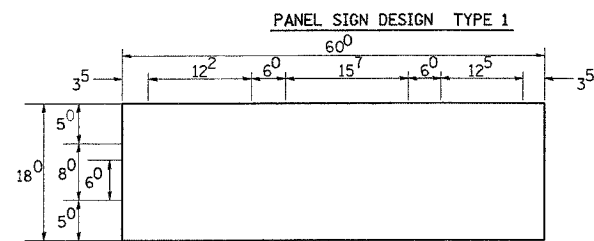

— Sq. M. each
— Sq. Ft. each
— Required
Design Series —

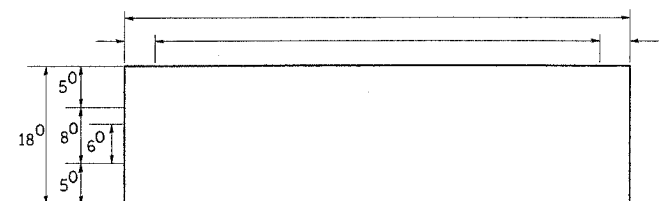

— Sq. M. each
— Sq. Ft. each
— Required
Design Series —

NOTE: SIGN DIMENSIONS ARE IN ENGLISH UNITS

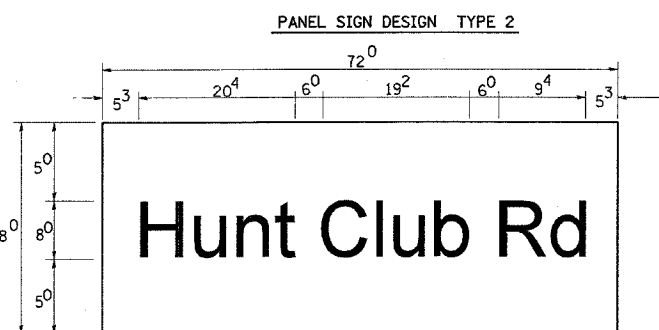

— 9 Sq. Ft. each
— 2 Required
Design Series C

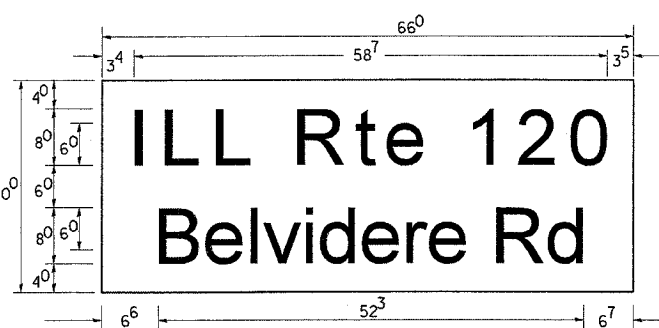

— 13.75 Sq. Ft. each
— 1 Required
Design Series D

GENERAL NOTES

- WHERE MAST ARM MOUNTED STREET NAME SIGNS ARE SPECIFIED, THE MAST ARM ASSEMBLY AND POLES SHALL BE DESIGNED TO SUPPORT THE LOADINGS CALLED FOR ON STANDARDS 834001, 834006 AND 834011, AS APPLICABLE, PLUS TWO (2) SIGN PANELS 2'-6" x 6'-0" MOUNTED AS SHOWN. THE DESIGN SHALL BE IN ACCORDANCE WITH THE REQUIREMENTS OF THE CURRENT "STANDARD SPECIFICATIONS FOR STRUCTURAL SUPPORTS FOR HIGHWAY SIGNS, LUMINAIRES, AND TRAFFIC SIGNALS" AS PUBLISHED BY THE AMERICAN ASSOCIATION OF STATE HIGHWAY AND TRANSPORTATION OFFICIALS FOR 80 M.P.H. WIND VELOCITY.
- ALL SIGNS SHALL HAVE A WHITE REFLECTORIZED LEGEND AND BORDER ON A GREEN REFLECTORIZED BACKGROUND, TYPE A SHEETING.
- THE SIGN LENGTH SHOULD BE INCREASED IN 6-INCH INCREMENTS, BUT THE OVERALL LENGTH SHOULD NOT EXCEED 6'-0".
- ALL BORDERS SHALL BE 3/4" WIDE AND CORNER RADIUS SHALL BE 2-1/4".
- SIGNFIX ALUMINUM CHANNEL FRAMING SYSTEM SHALL BE USED FOR ALL SIGNS ATTACHED TO SIGNAL POLES AND POSTS. LOCAL SUPPLIERS OF THE SIGNFIX ALUMINUM CHANNEL FRAMING SYSTEM ARE:
 - * A.K.T. CORPORATION, SCHALMURG, IL
 - * TUCKER COMPANY, INC., WAUWATOSA, WI
 - * AMERICAN FABRICATION CO., CHICAGO HEIGHTS, IL
 - * WESTERN TRAFFIC CONTROL INC., CICERO, IL

PARTS LISTING:
SIGN CHANNEL PART #HPN053 (MED. CHANNEL)
SIGN SCREWS 1/4" x 14 x 1" H.W.H. #3
BRACKETS SELF TAPPING WITH NEOPRENE WASHER
PART #HPN034 (UNIVERSAL)
CHANNEL CLAMPS WITH STAINLESS STEEL STRAPPING
OTHER BRANDS OF MOUNTING HARDWARE ARE ACCEPTABLE, BASED UPON THE DEPARTMENT'S APPROVAL AND COMPATIBILITY WITH THE CHANNEL/BACKET OF THE ABOVE PRODUCT.

SUPPORTING CHANNELS

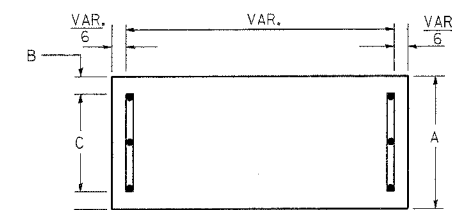

A	B	C
18"	2"	14"

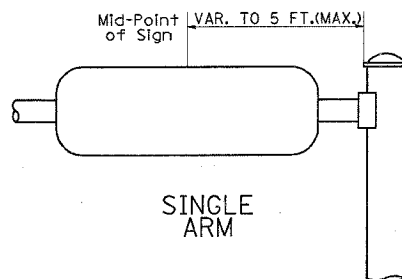

SINGLE ARM

SUPPORTING CHANNELS

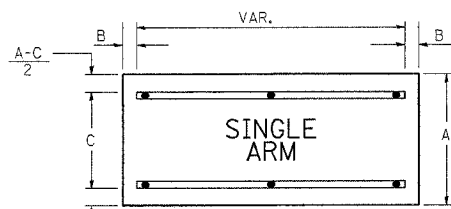

A	B	C
18"	2"	12"
30"	2"	22"

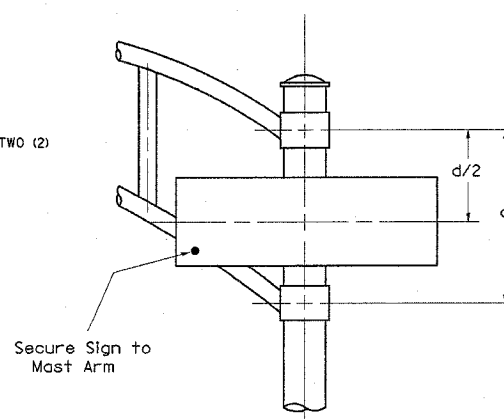

DUAL ARM

SIGNFIX ALUMINUM CHANNEL FRAMING SYSTEM
Shall be used. See Note #5.

Upper Case To Lower Case
Spacing Chart 8-6 Inch Series "C & D"

EXAMPLE, 2 DENOTES 3/8

SERIES	SECOND LETTER															
	a		b		c		d		e		f		g		h	
	code	goq	bh	ikl	m	npru	f	w	J	s	t	v	y	x	z	
A W X	12	14	14	15	12	14	06	10	11	14	06	10	11	12	12	14
B	14	15	20	21	14	15	11	12	14	15	12	14	12	14	16	17
C E G	14	15	20	21	12	14	06	10	12	14	12	14	14	15	14	15
D O Q R	14	15	20	21	14	15	06	10	12	14	12	14	14	15	14	15
F	05	06	14	15	06	10	05	06	06	10	06	10	06	10	11	12
H I M N	20	21	22	24	20	21	14	15	16	17	16	17	20	21	20	21
J U	20	21	20	21	16	17	14	15	16	17	16	17	16	17	20	21
K L	11	12	16	17	11	12	05	06	11	12	11	12	11	12	12	14
P	12	14	14	15	12	14	05	06	11	12	11	12	12	14	12	14
S	12	14	16	17	12	14	06	10	12	14	12	14	12	14	12	14
T	11	12	16	17	06	10	06	10	11	12	11	12	11	12	12	14
V	06	10	14	15	11	12	06	10	12	14	12	14	12	14	12	14
Y	05	06	14	15	06	10	05	06	05	07	05	06	06	10	11	12
Z	16	17	22	24	16	17	12	14	16	17	16	17	16	17	20	21

Lower Case To Lower Case
Spacing Chart 6 Inch Series "C & D"

SERIES	SECOND LETTER															
	a		b		c		d		e		f		g		h	
	code	goq	bh	ikl	m	npru	f	w	J	s	t	v	y	x	z	
ad h g i j	16	17	22	24	16	17	12	14	14	15	14	15	16	17	16	17
l m n q u	16	17	22	24	16	17	12	14	14	15	14	15	16	17	16	17
b f k o p s	12	14	16	17	11	12	05	06	11	12	11	12	12	14	12	14
c e	12	14	16	17	12	14	06	10	12	14	12	14	12	14	12	14
r	06	10	12	14	06	10	03	03	05	06	05	06	06	10	06	10
t z	12	14	16	17	12	14	06	10	11	12	11	12	12	14	12	14
v y	11	12	14	15	11	12	05	06	06	10	06	10	11	12	11	12
w	11	12	14	15	11	12	05	06	11	12	11	12	11	12	12	14
x	12	14	16	17	11	12	05	06	11	12	11	12	11	12	12	14

Number To Number
Spacing Chart 8 Inch Series "C & D"

SERIES	SECOND NUMBER																			
	0		1		2		3		4		5		6		7		8		9	
	C	D	C	D	C	D	C	D	C	D	C	D	C	D	C	D	C	D	C	D
0 9	16	17	16	17	14	15	12	14	14	15	14	15	16	17	12	14	16	17	16	17
1	20	21	20	21	20	21	16	17	14	15	20	21	20	21	14	15	20	21	20	21
2 3 4	14	15	14	15	14	15	12	14	12	14	14	15	14	15	11	12	16	17	14	15
5	14	15	14	15	14	15	11	12	11	12	14	15	14	15	11	12	14	15	14	15
6	16	17	14	15	14	15	12	14	14	15	14	15	14	15	11	12	14	15	14	15
7	12	14	12	14	14	15	12	15	05	06	12	14	14	15	11	12	14	15	12	14
8	16	17	16	17	14	15	12	14	14	15	16	17	12	14	16	17	14	15	14	15

LETTERS	UPPER AND LOWER CASE LETTER WIDTHS						
	6 INCH UPPER CASE LETTERS		8 INCH UPPER CASE LETTERS		LETTERS	6 INCH LOWER CASE LETTERS	
	C	D	C	D		C	D
A	36	50	50	65	a	35	42
B	32	40	43	53	b	35	42
C	32	40	43	53	c	35	41
D	32	40	43	53	d	35	42
E	30	35	40	47	e	35	42
F	30	35	40	47	f	23	26
G	32	40	43	53	g	35	42
H	32	40	43	53	h	35	42
I	07	07	11	12	i	11	11
J	30	36	40	50	j	20	22
K	32	41	43	54	k	35	42
L	30	35	40	47	l	11	11
M	37	45	51	61	m	60	70
N	32	40	43	53	n	35	42
O	34	42	45	55	o	36	43
P	32	40	43	53	p	35	42
Q	34	42	45	55	q	35	42
R	32	40	43	53	r	26	32
S	32	40	43	53	s	36	42
T	30	35	40	47	t	27	32
U	32	40	43	53	u	35	42
V	35	44	47	60	v	42	47
W	44	52	60	70	w	55	64
X	34	40	45	53	x	44	51
Y	36	50	50	66	y	46	53
Z	32	40	43	53	z	36	43

NUMBER	6 INCH SERIES		8 INCH SERIES	
	C	D	C	D
1	12	14	15	20
2	32	40	43	53
3	32	40	43	53
4	35	43	47	57
5	32	40	43	53
6	32	40	43	53
7	32	40	43	53
8	32	40	43	53
9	32	40	43	53
0	34	42	45	55

REVISIONS	
NAME	DATE
D.A.Z./D.A.G.	11/90
	6/98
CADD	10/00

Illinois Department of Transportation
DISTRICT 1
MAST ARM MOUNTED STREET NAME SIGNS
SCALE: NONE
DATE: 5/31/2006
DRAWN BY: RDB
DESIGNED BY: JHE
CHECKED BY: DAD