

SECTION	COUNTY	TOTAL SHEETS	SHEET NO.
02-00090-00-BT	DUPAGE	117	36
STA. TO STA.			
IDOT PROJECT NO. M-8003(222)			
SALT CREEK GREENWAY TRAIL			
CONTRACT NO. 83713			

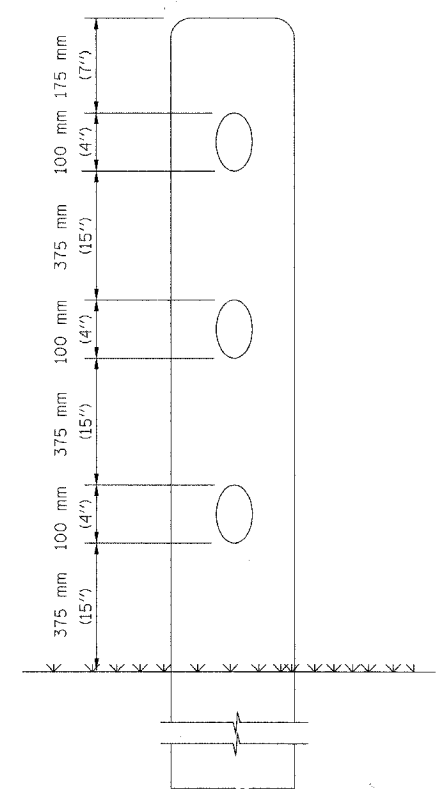

SIDE VIEW

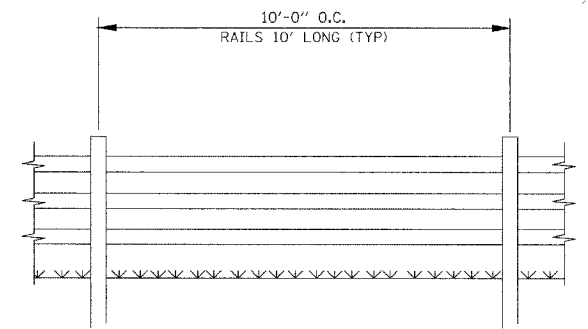

FRONT VIEW

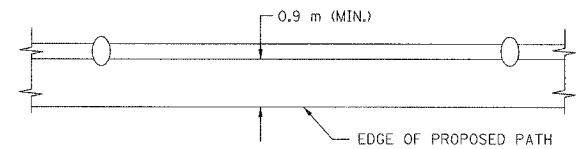

TOP VIEW

NOTE: ALL RAILS SHALL BE SPIKED TO POST W/GALVANIZED GUTTER SPIKES.

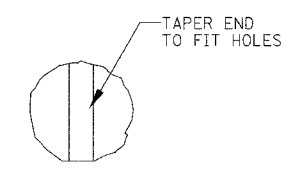

RAIL END (TYP.)

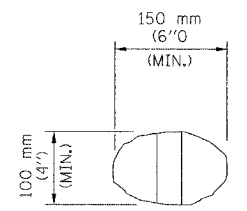

LINE POST-TOP (TYP.)

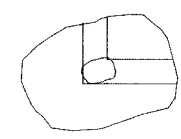

CORNER POST-TOP (TYP.)

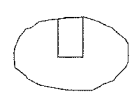

END POST TOP (TYP.)

RUSTIC RAIL FENCE DETAIL

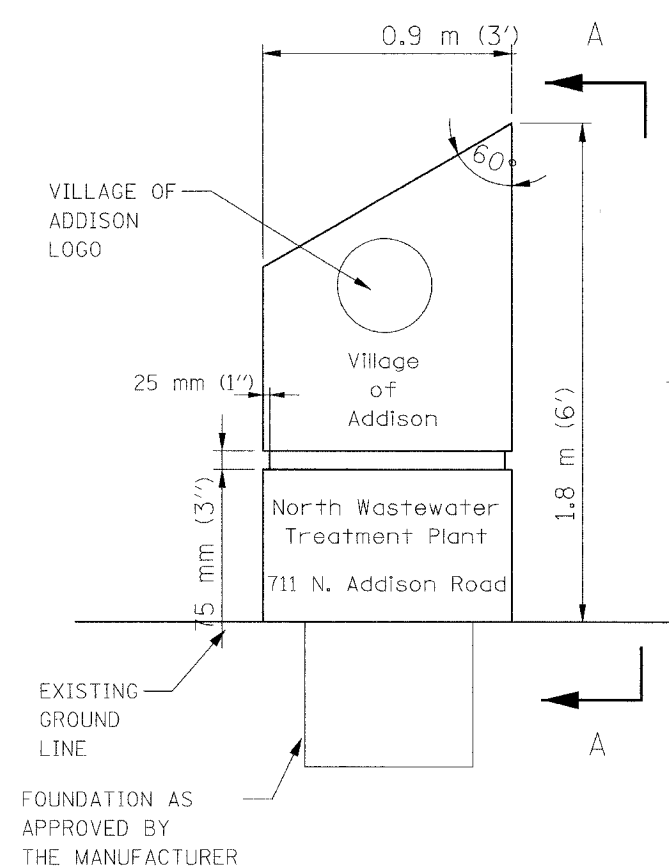

ENTRANCE MONUMENT DETAIL

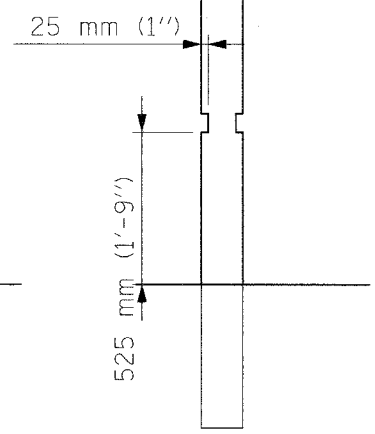

SECTION A-A

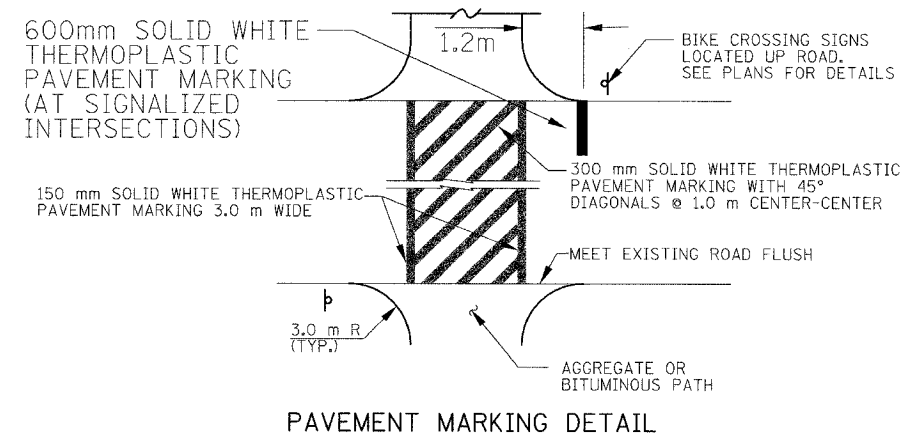

PAVEMENT MARKING DETAIL

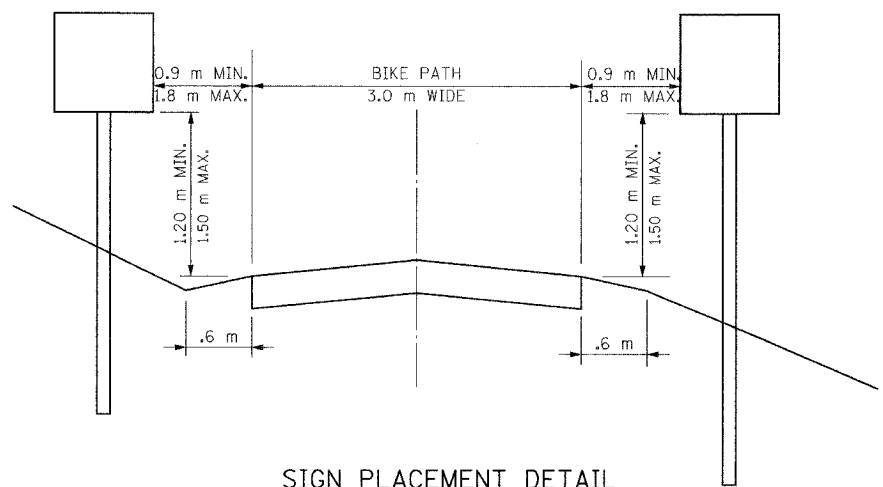

SIGN PLACEMENT DETAIL

REVISIONS		
NO.	NAME	DATE

URS 1701 GOLF ROAD, SUITE 1000 TEL (847) 228-0707
 ROLLING MEADOWS, IL 60008 FAX (847) 228-1115

VILLAGE OF ADDISON
SALT CREEK GREENWAY TRAIL
 MISCELLANEOUS DETAILS

DATE: 10/22/04 DRAWN BY: MIA&VP
 DESIGNED BY: MIA CHECKED BY: DDL