

F.A.P. RTE.	SECTION	COUNTY	TOTAL SHEETS	SHEET NO.
22	6M & TS	HENRY	257	129
STA.		TO STA.		
FED. ROAD DIST. NO.	ILLINOIS	FED. AID PROJECT		

# THRUST BLOCK DETAILS

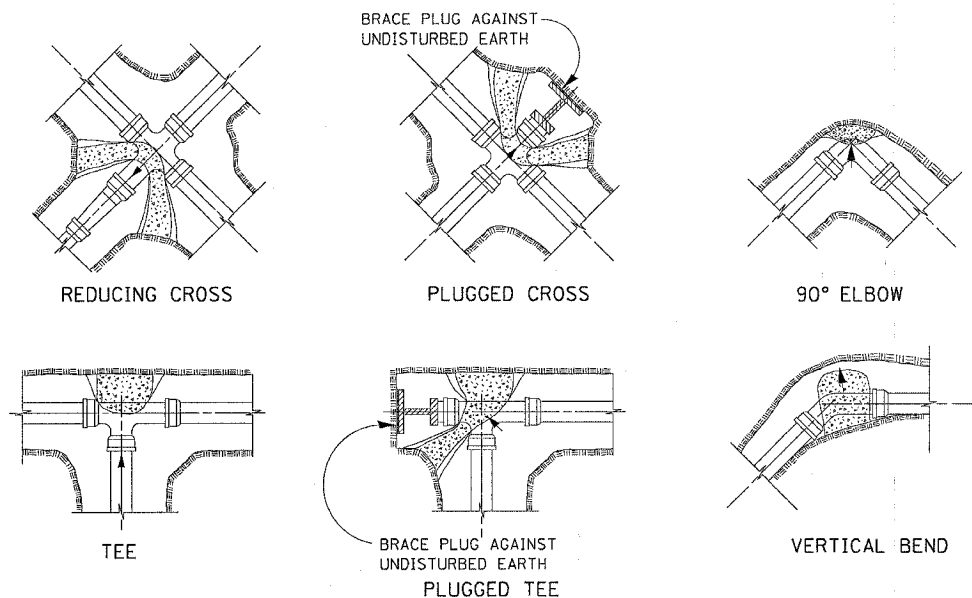

NOTES:  
 ALL BLOCKS TO BEAR AGAINST UNDISTURBED EARTH.  
 ARROWS INDICATE DIRECTION OF THRUST.  
 ALL BLOCKS TO BE CLASS SI CONCRETE.  
 ALL FITTINGS SHOWN IN PLAN EXCEPT VERTICAL BEND.

ALL DIMENSIONS ARE IN MILLIMETERS (INCHES) UNLESS OTHERWISE NOTED.

**THRUST BLOCK DETAILS 34.4**

REVISED 10-20-87

# SIDEWALK AND DRIVEWAY PAVEMENT PAY AREAS

- PAY FOR AS
- SIDEWALK REMOVAL
  - DRIVEWAY PAVEMENT REMOVAL
  - PCC SIDEWALK 127 (5)
  - PCC DRIVEWAY PAVEMENT 178 (7)

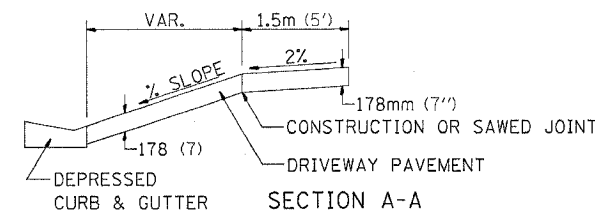
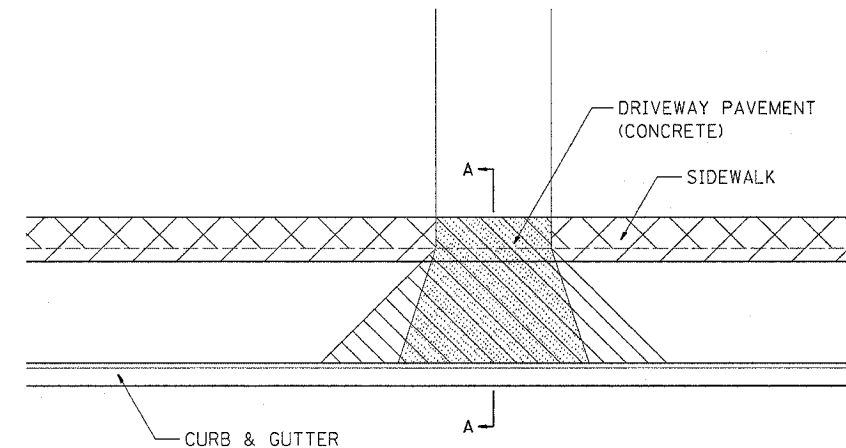

FOR DETAILS ON DIMENSIONS AND GRADES, SEE DISTRICT STANDARD 25.1 OR PLANS.

ALL DIMENSIONS ARE IN MILLIMETERS (INCHES) UNLESS OTHERWISE NOTED.

**SIDEWALK AND DRIVEWAY PAVEMENT PAY AREAS 35.4**

REVISED 10-15-04

# INFORMATIONAL WARNING SIGN (FOR NARROW TRAVEL LANES)

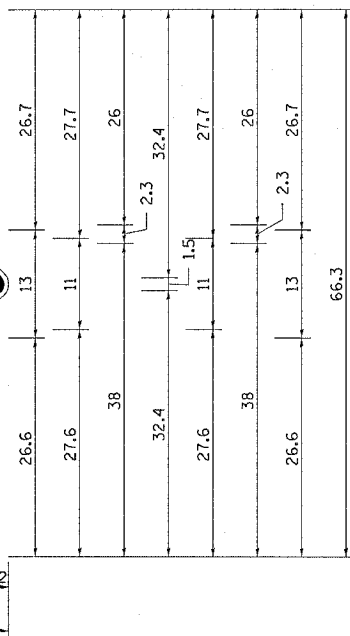
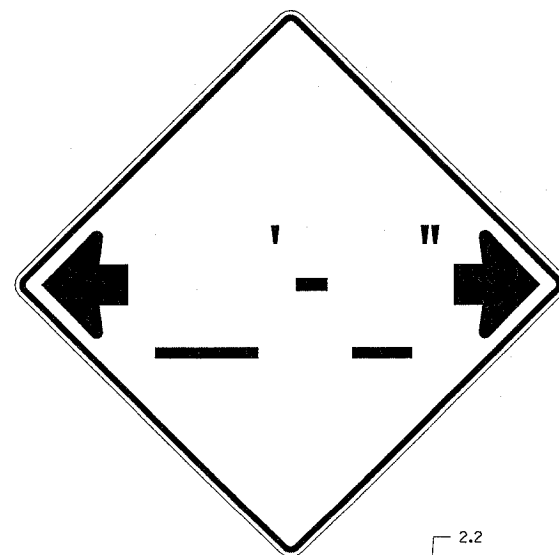

NOTES  
 W12-2 - Horizontal Clearance Sign  
 48.0" across sides, 1.9" Radius,  
 0.8" Border, 0.5" Indent, Black on  
 Orange; Standard Arrow Custom  
 10.4" X 8.1" 180° Black 1/2 Inch  
 D Series Lettering; Standard Arrow  
 Custom 10.4" X 8.1" 0°

All work to furnish and install these signs shall be included in the cost of the Traffic Control Standards and shall not be paid for separately.

ALL DIMENSIONS ARE IN INCHES UNLESS OTHERWISE NOTED.

**INFORMATIONAL WARNING SIGN (FOR NARROW TRAVEL LANES) 39.4**

REVISED 6-29-05

# REFERENCE MARKERS

REFERENCE MARKER & LAND SECTION MARKER

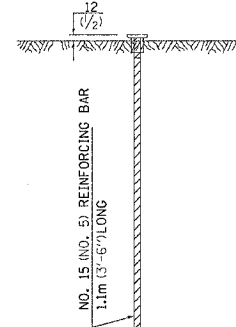

SECTION



R.O.W. CAP

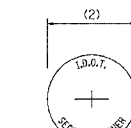

SECTION CORNER CAP

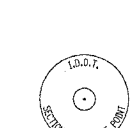

SECTION CORNER TIE POINT CAP

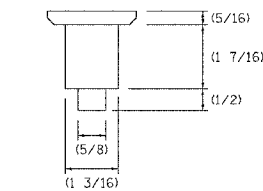

CAP DETAIL

METHOD OF REFERENCING MARKERS

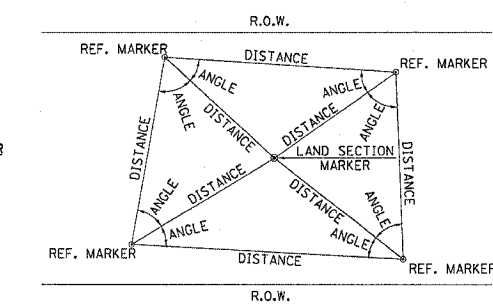

- USE INSTRUMENT TIES TO NEARBY LAND-MARKS (STEEPLES, TOWERS, SILOS, ETC...)
- IN CULTIVATED FIELDS, SET 600(2') OR MORE BELOW GROUND SURFACE.
- IN FENCE LINE OR PROTECTED AREA SET TOP AT GROUND LEVEL.

ALL DIMENSIONS ARE IN MILLIMETERS (INCHES) UNLESS OTHERWISE NOTED.

**REFERENCE MARKERS 63.4**

REVISED 4-22-05

PLOT DATE = Thu Oct 27 08:45:51 2005  
 FILE NAME = c:\pwork\2218800\101800pldgn  
 PLOT SCALE = 50  
 REFERENCE = REFERS