

PLAN
(ONLY APPLIES TO STA. 11+56.6)

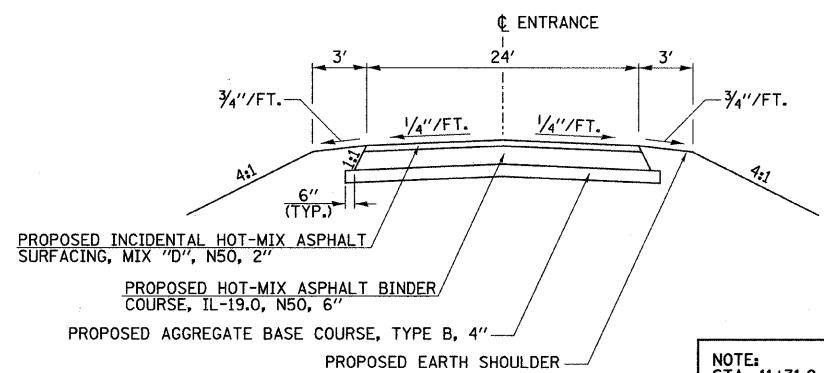

SECTION B-B

NOTE:
STA. 11+31.0 (ON SKEW) LT.
SANITARY ACCESS DRIVE
WILL MATCH EXISTING WIDTH
AND IS THE SAME PAVEMENT
THICKNESS AS SECTION A-A.
ALSO SEE CROSS SECTION.

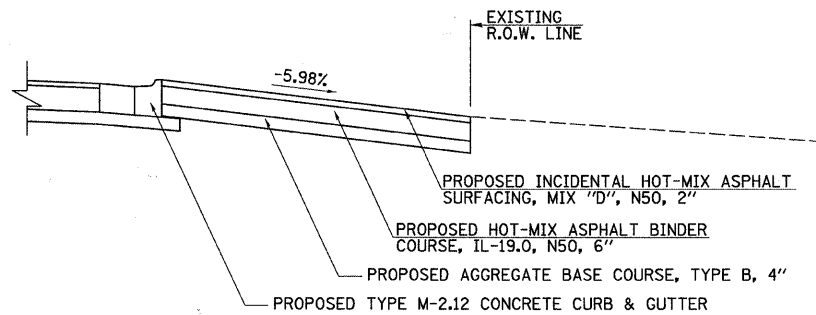

SECTION A-A

PRIVATE ENTRANCE WITH CURB & SIDEROAD DETAILS

STA. 11+31.0 (LT. (SEE NOTE))
STA. 11+56.6 (RT.)

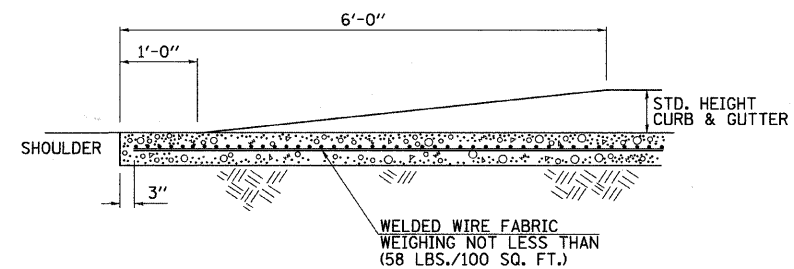

CURB DETAIL

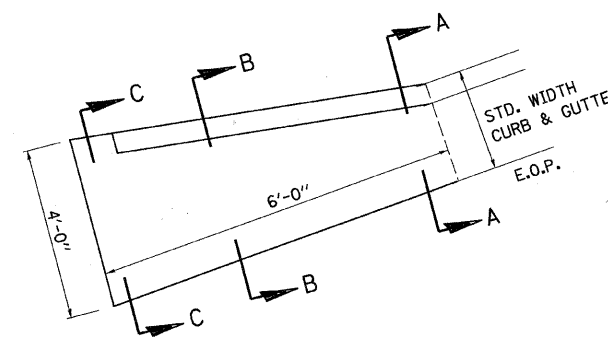

PLAN

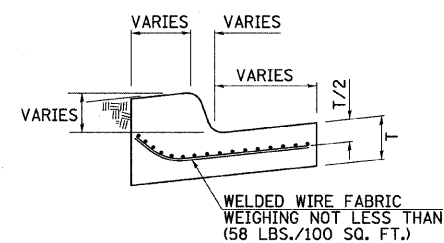

SECTION A-A

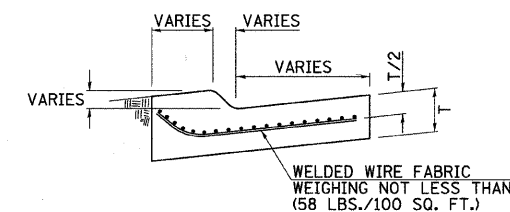

SECTION B-B

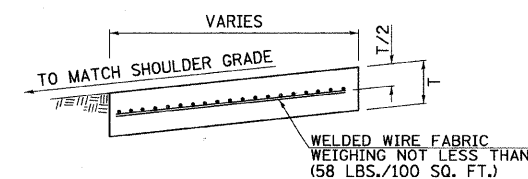

SECTION C-C

CURB & GUTTER OUTLET, SPECIAL

(TO BE PAID FOR AS COMBINATION CONCRETE CURB & GUTTER, TYPE M-2.12)

FILE NAME = v:\2882\2882h\01.dgn	USER NAME = bdeorane	DESIGNED -	REVISED -
		DRAWN -	REVISED -
	PLOT SCALE = 20.000000 "/ IN.	CHECKED -	REVISED -
	PLOT DATE = 10/3/2011	DATE -	REVISED -

**STATE OF ILLINOIS
DEPARTMENT OF TRANSPORTATION**

JOLIET ST., ENTRANCE & SPECIAL DETAILS

SCALE: N/A SHEET NO. 1 OF 1 SHEETS STA. N/A TO STA. N/A

RTE. NO.	SECTION	COUNTY	TOTAL SHEETS	SHEET NO.
N/A	07-10117-00-BR	WILL	36	8
CONTRACT NO. 63642				
FED. ROAD DIST. NO.		ILLINOIS FED. AID PROJECT		