

FABRIC BEARING PAD
(Interior - 12 Req'd.)

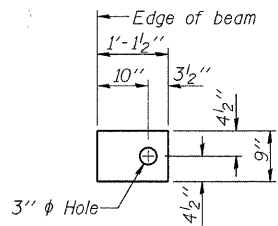

FABRIC BEARING PAD
(Exterior - 4 Req'd.)

Notes:
All bearing pads shall be 1" thick.
Omit holes when using expansion bearings.
Expansion bearing pad shall be bonded to the substructure.

FIXED

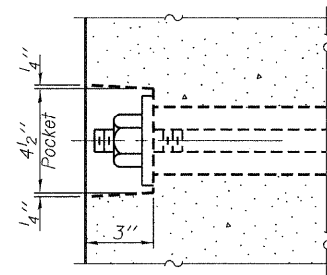

SECTION A-A

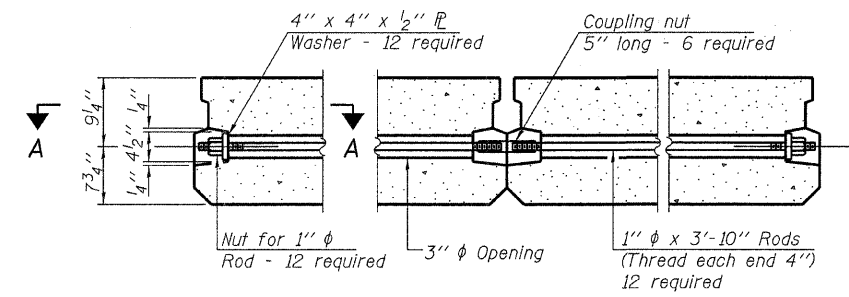

TYPICAL TRANSVERSE TIE ASSEMBLY

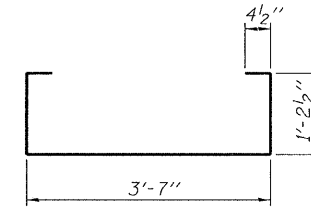

BAR S(E)

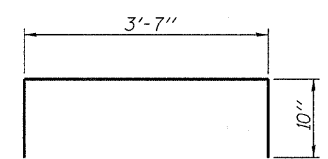

BAR S1(E)

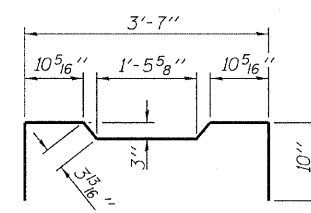

BAR S2(E)

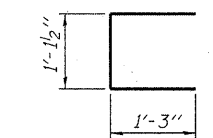

BAR U(E)

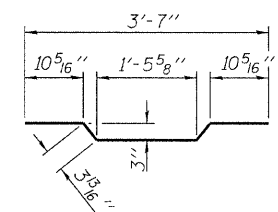

BAR A1(E)

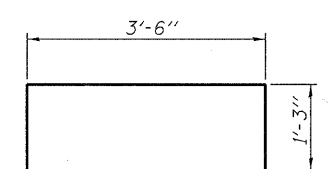

BAR U1(E)

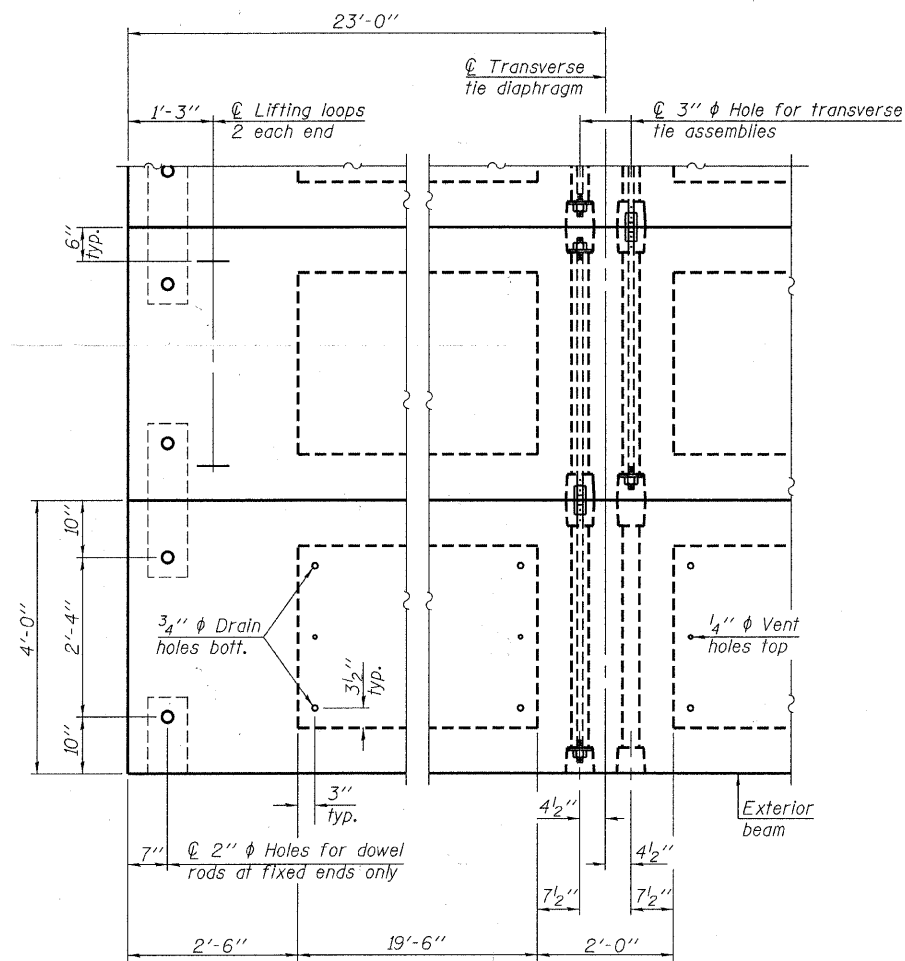

PLAN VIEW

Note: Connect beams in pairs with the transverse tie configuration shown.

NOTES

Prestressing steel shall be uncoated high strength, low relaxation 7-wire strand, Grade 270. The nominal diameter shall be 1/2" and the nominal cross-sectional area shall be 0.153 sq. in. The 1" rods in the transverse tie assembly shall be tightened to a snug fit and the threads set. Pockets on exterior faces of bridge shall be filled with grout after transverse tie assembly is in place.
Reinforcement bars shall conform to ASTM A 706, Grade 60. (See Special Provisions).
Two 1/8" fabric adjusting shims of the dimensions of the exterior bearing pad shall be provided for each bearing pad location.
A minimum 2 1/2" diameter lifting pin shall be used to engage the lifting loops during handling.
Corrosion Inhibitor, per Article 1020.05(b)(12) and 1021.06 of the Standard Specifications, shall be used in the concrete for precast prestressed concrete deck beams.
Compressive strength of prestressed concrete, f'c, shall be 6000 psi.
Compressive strength of prestressed concrete at release, f'ci, shall be 5000 psi.
All bars shall be epoxy coated.

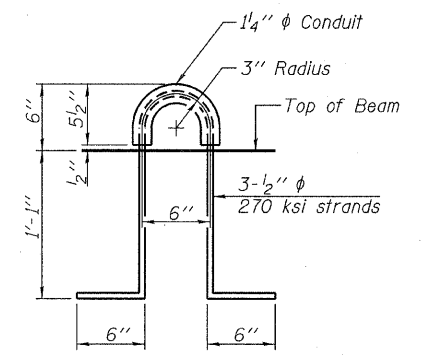

LIFTING LOOP DETAIL

BILL OF MATERIAL

Precast Prestressed Conc. Deck Bms. (17" depth)	Sq. Ft.	1,288
---	---------	-------

PD-1748-OD 7-1-10

FILE NAME = 100078-shc-bridge.dgn	USER NAME =	DESIGNED - A.S.L.	REVISED -
HAMPTON, LENZINI AND RENWICK, INC.		CHECKED - S.W.M.	REVISED -
3008 STEVENSON DRIVE, SUITE 201 SPRINGFIELD, ILLINOIS 62703	PLOT SCALE =	DRAWN - D.A.B.	REVISED -
ILLINOIS PROFESSIONAL DESIGN FIRM L3/P/E/SE CORP. 18-000099	PLOT DATE = 10/27/2011	CHECKED - S.W.M.	REVISED -

STATE OF ILLINOIS
EFFINGHAM COUNTY HIGHWAY DEPARTMENT

17" x 48" PPC DECK BEAM DETAILS
STRUCTURE NO. 025-3323

SHEET NO. 3 OF 8 SHEETS

T.R.	SECTION	COUNTY	TOTAL SHEETS	SHEET NO.
266	10-13112-00-BR	EFFINGHAM	21	16
UNION ROAD DISTRICT		CONTRACT NO. 95669		
ILLINOIS FED. AID PROJECT				