

RTE.	SECTION	COUNTY	TOTAL SHEETS	SHEET NO.
FAI80	150-21HBR	LA SALLE	460	34
STA.		TO STA.		
FED. ROAD DIST. NO.		ILLINOIS FED. AID PROJECT		

CONTRACT NO. 86603

RAMP E TIES

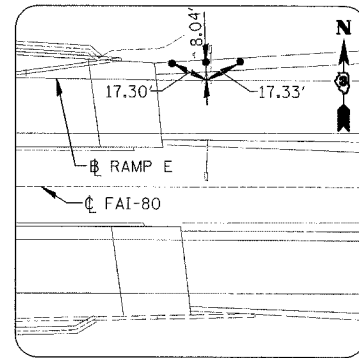

RAMP E - POT STA. 164+04.17
N. 50049.78 E. 67478.83

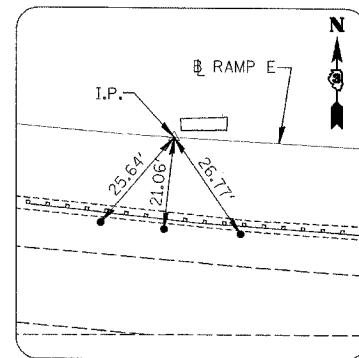

RAMP E - PC STA. 172+02.42
N. 50093.58 E. 66681.78

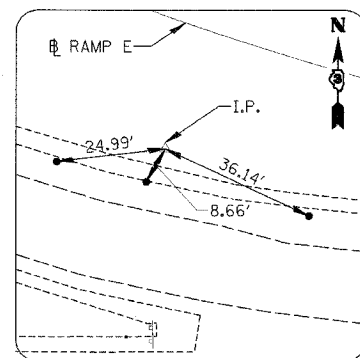

RAMP E - PI STA. 174+12.66
N. 50105.12 E. 66471.86

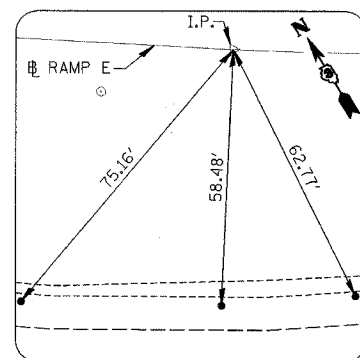

RAMP E - PT STA. 176+12.50
N. 50223.54 E. 66298.14

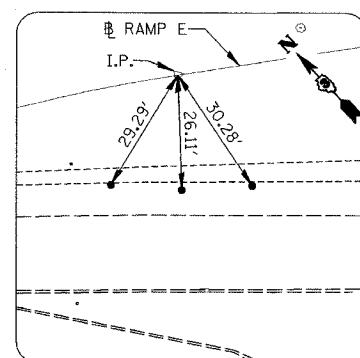

RAMP E - PC STA. 179+36.24
N. 50406.71 E. 66031.21

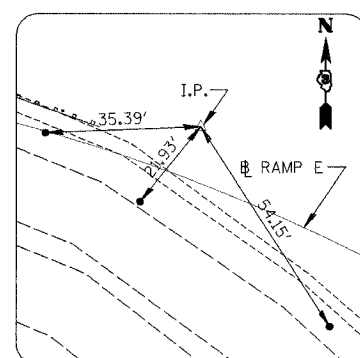

RAMP E - PI STA. 180+36.60
N. 50463.24 E. 65948.28

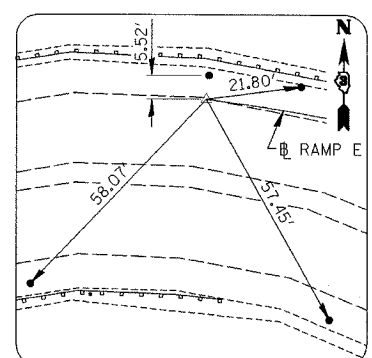

RAMP E - PT STA. 181+33.09
N. 50475.09 E. 65848.63

RAMP G TIES

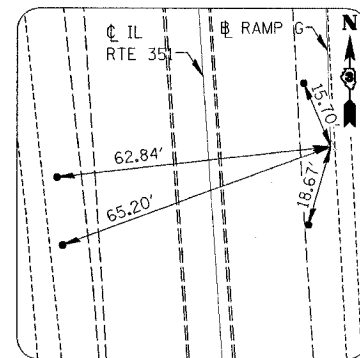

RAMP G - POT STA. 232+63.18
N. 48920.04 E. 65721.15

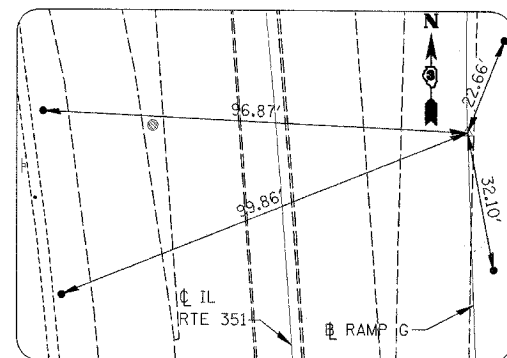

RAMP G - PC STA. 237+20.79
N. 49377.37 E. 65705.04

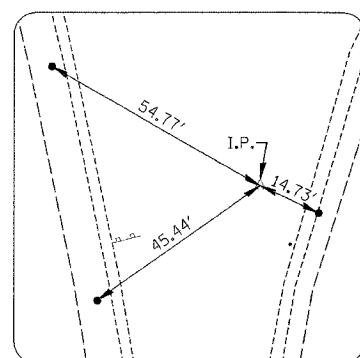

RAMP G - PI STA. 239+75.08
N. 49631.50 E. 65696.10

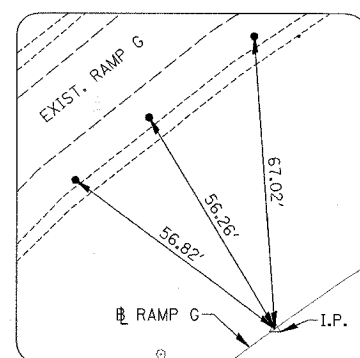

RAMP G - PCC STA. 241+87.85
N. 49780.12 E. 65902.43

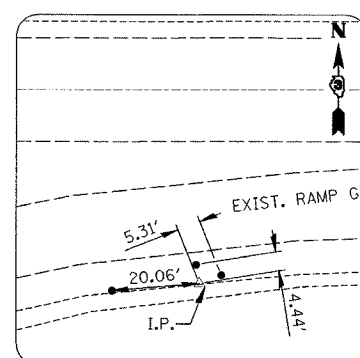

RAMP G - PI STA. 244+27.93
N. 49920.44 E. 66097.24

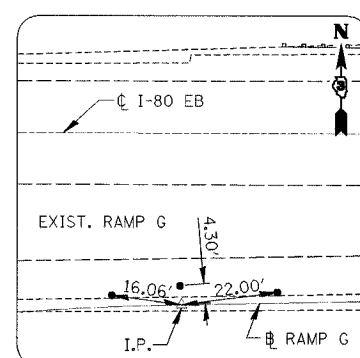

RAMP G - PT STA. 246+53.34
N. 49925.35 E. 66337.27

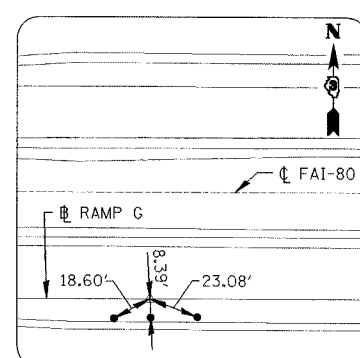

RAMP G - POT STA. 259+48.91
N. 49951.87 E. 67632.57

NOTE: ALL CONTROL AND TIE POINTS ARE PK NAILS EXCEPT AS NOTED.

REVISIONS	NAME

ILLINOIS DEPARTMENT OF TRANSPORTATION

TIES

F.A.I. 80 AT ILLINOIS ROUTE 351

SCALE: NONE
DATE: 09/04

DRAWN BY: JDC
CHECKED BY: MTD