

CENTERLINE INTERSTATE OR MULTI-LANE TWO WAY DIVIDED HIGHWAY

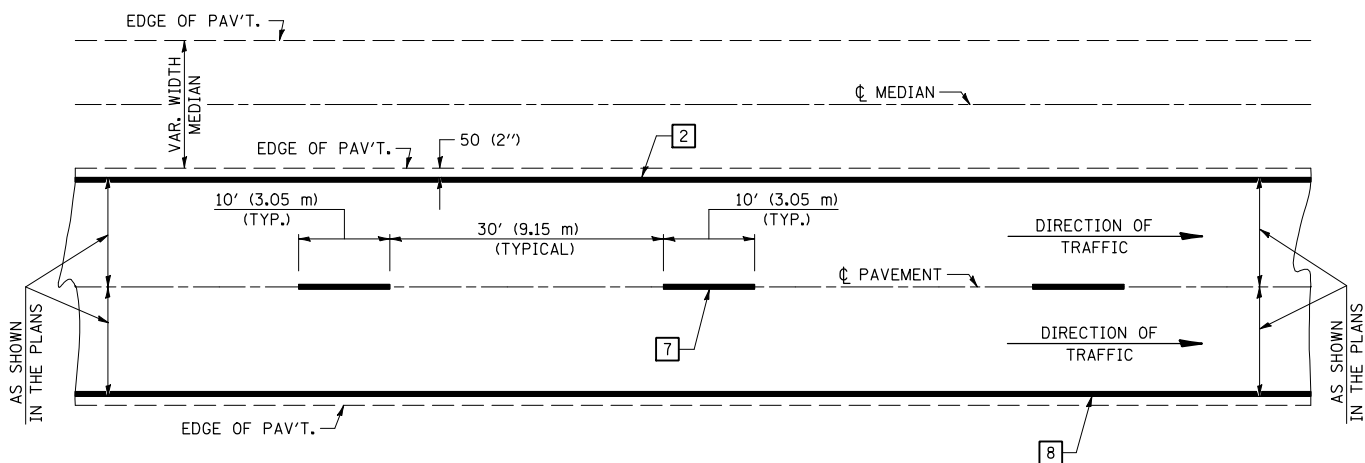

NOTE: PAVEMENT MARKINGS ARE TO BE EXTENDED THROUGH OMISSIONS WHEN APPLICABLE.

NOTE: SEE ARTICLES 780.04 & 781.03 FOR LOCATION OF STRIPES AND MARKERS RELATIVE TO EDGES OR JOINTS.

FOR RAISED REFLECTIVE PAVEMENT MARKERS, REFER TO STANDARD 781001.

TYPICAL EXIT RAMP TERMINAL

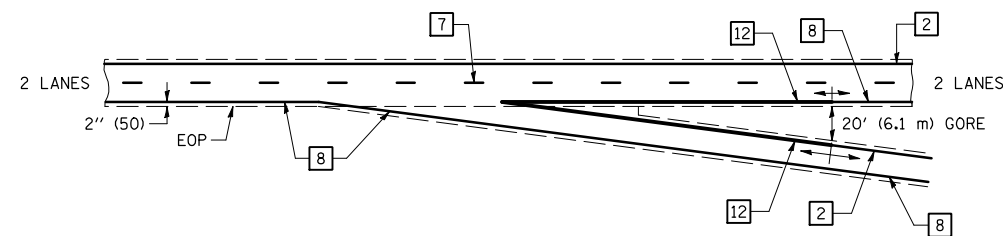

EXIT RAMP TERMINAL with EXCLUSIVE (auxiliary) LANE

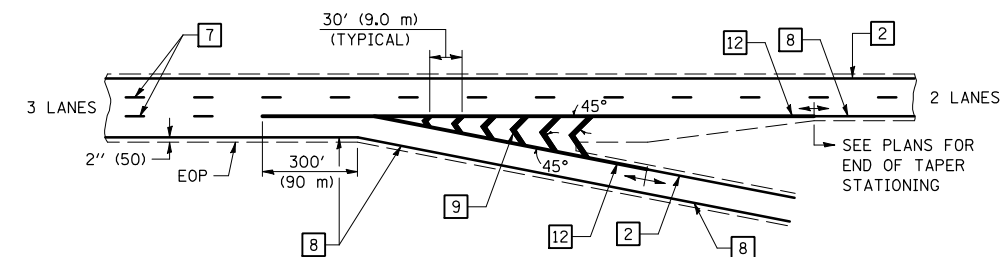

TYPICAL PAVEMENT MARKING LEGEND

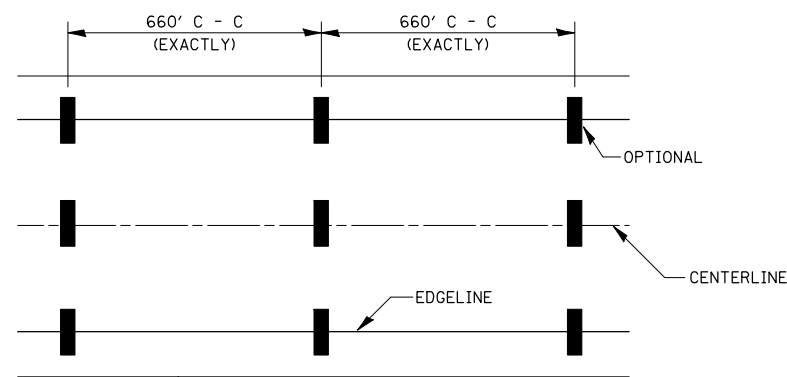

- 1 4" (100) SKIP-DASH (YELLOW)
- 2 4" (100) SOLID (YELLOW)
- 3 12" (300) DIAGONAL (YELLOW)
- 4 4" (100) DOUBLE YELLOW (NARROW)
- 5 RESERVED
- 6 RESERVED
- 7 4" (100) SKIP-DASH (WHITE)
- 8 4" (100) SOLID (WHITE)
- 9 12" (300) DIAGONAL (WHITE)
- 10 6" (150) SOLID (WHITE)
- 11 24" (600) STOP BAR (WHITE)
- 12 8" (200) SOLID (WHITE)
- 13 4" (100) LANE LINE EXTENSIONS (WHITE)

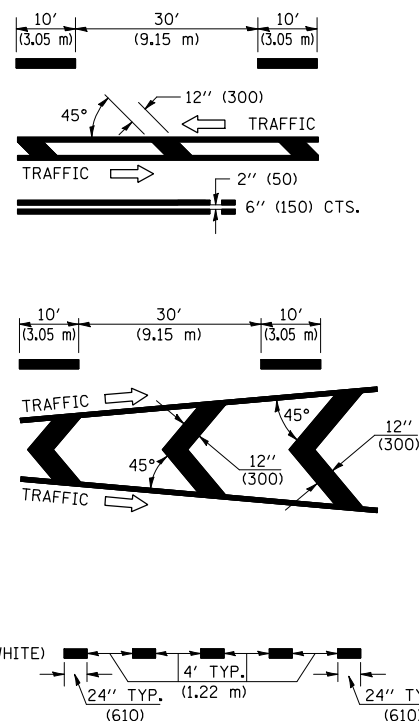

TYPICAL ENTRANCE RAMP TERMINAL

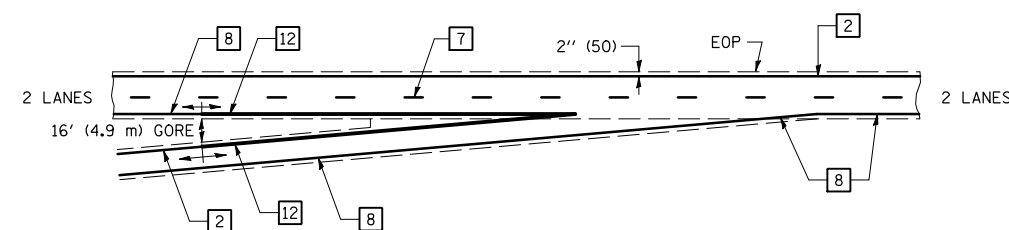

ENTRANCE RAMP TERMINAL with EXCLUSIVE LANE

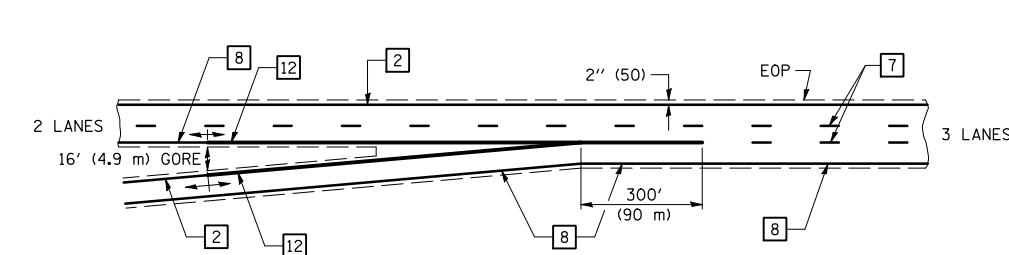

IT WILL BE NECESSARY TO HAVE A REPRESENTATIVE OF THE STATE POLICE PRESENT SO THAT THE ACCURACY OF MEASUREMENT CAN BE ATTESTED TO IN COURT.

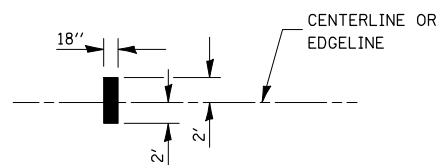

AERIAL SPEED CHECK ZONES

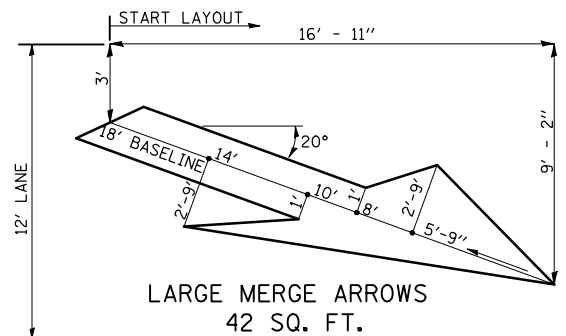

Note: All dimensions are in INCHES (millimeters) unless otherwise shown.

•FAU 7052 / FAP 729

DISTRICT 5 DETAIL NO. 7800BBBB

FILE NAME =	USER NAME = bucklesJJ	DESIGNED -	REVISED - 11/06
et\pwwork\pwwid01\BUCKLESJJ\d0132727\0970315-sht-details.dgn		DRAWN -	REVISED -
PLOT SCALE = 40.0000 ' / IN.		CHECKED -	REVISED -
PLOT DATE = 12/7/2009		DATE -	REVISED -

STATE OF ILLINOIS  
DEPARTMENT OF TRANSPORTATION

PAVEMENT MARKING (INTERSTATE & MULTI-LANE APPLICATIONS)

SCALE: SHEET NO. OF SHEETS STA. TO STA.

F.A.* RTE.	SECTION	COUNTY	TOTAL SHEETS	SHEET NO.
*		VERMILION	58	58
CONTRACT NO. 70315				
FED. ROAD DIST. NO. ILLINOIS FED. AID PROJECT				