

F.A. RTE.	SECTION	COUNTY	TOTAL SHEETS	SHEET NO.
*	**	LA SALLE	48	9

STA. \_\_\_\_\_ TO STA. \_\_\_\_\_  
 FED. ROAD DIST. NO. \_\_\_\_\_ ILLINOIS FED. AID PROJECT  
 \* FAP 68 & 68 ALT (IL 23 NB & SB)  
 \*\* (35, 51 & 48 CS, 12)TS

ELECTRICAL LOAD FOR INTERSECTION				
STREET NAME	COMPONENT	NUMBER	WATTAGE EACH	BURNTIME %
LA SALLE STREET (IL 23 SB)	RED	4	10	42
	YELLOW	4	19	5
	GREEN	4	14	53
		4	7	100
		4	5	53
WASHINGTON STREET	RED	4	10	68
	YELLOW	4	19	5
	GREEN	4	14	27
		4	7	100
		4	5	27
TRAFFIC SIGNAL CABINET	CONTROLLER	1	6	100
	UPS	1	50	100
	EMERGENCY VEHICLE PREEMPT	3	--	--

AGENCY RESPONSIBLE FOR TRAFFIC SIGNAL ENERGY CHARGES:  
CITY OF OTTAWA

NOTE:  
DAMPENING DEVICE SHALL CONSIST OF A 24" X 30" TYPE 1, UNPAINTED ALUMINUM SIGN STOCK MOUNTED HORIZONTALLY ON TOP OF MAST ARM WITH THE 30" LENGTH PERPENDICULAR TO THE ARM. COST OF THE DAMPENING DEVICE IS INCLUDED IN THE MAST ARM PAY ITEM.

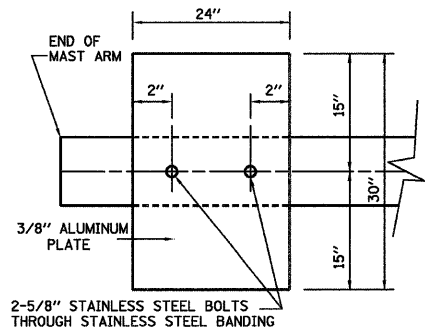

NOTE:  
MOUNT DAMPENING PLATE TO END OF EACH TRAFFIC SIGNAL MAST ARM.  
**DAMPENING PLATE DETAIL - TOP VIEW**

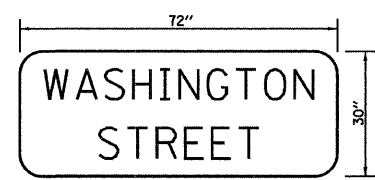

TYPE ZZ SHEETING REQUIRED  
8" D SERIES LETTERS  
1 SIGNS REQUIRED = 15 SQ. FT. EACH  
= 15 SQ. FT. TOTAL

THIS STREET NAME SIGN SHALL BE PLACED ON THE MAST ARMS PARALLEL WITH WASHINGTON STREET

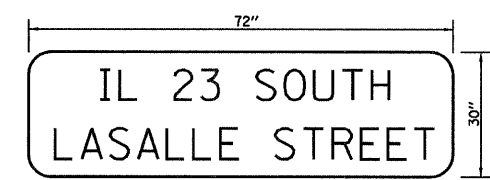

TYPE ZZ SHEETING REQUIRED  
8" D SERIES LETTERS (STATE ROUTE LETTERING)  
6" D SERIES LETTERS (CITY STREET LETTERING)  
2 SIGNS REQUIRED = 15 SQ. FT. EACH  
= 30 SQ. FT. TOTAL

THIS STREET NAME SIGN SHALL BE PLACED ON THE MAST ARMS PARALLEL WITH LA SALLE STREET

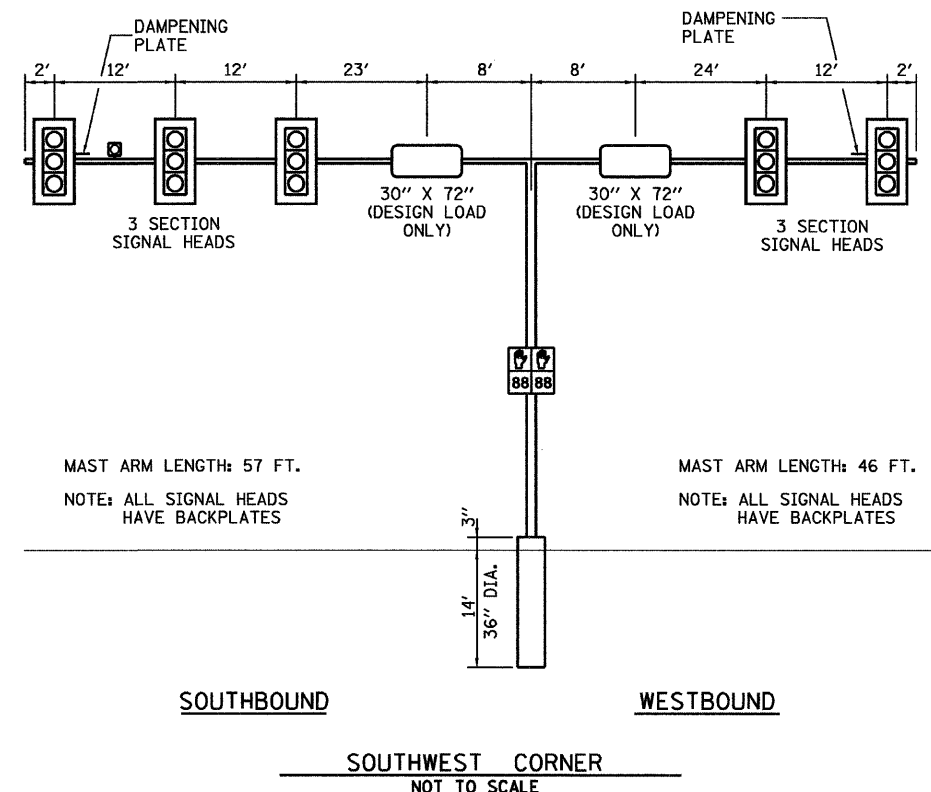
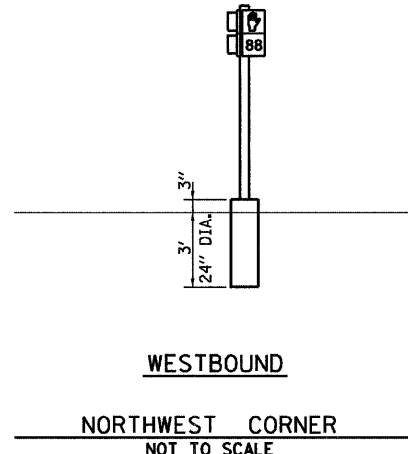
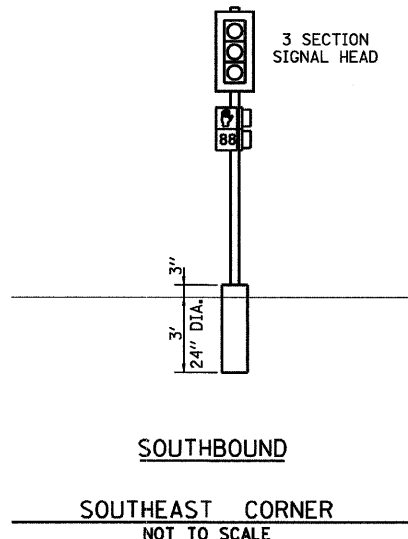
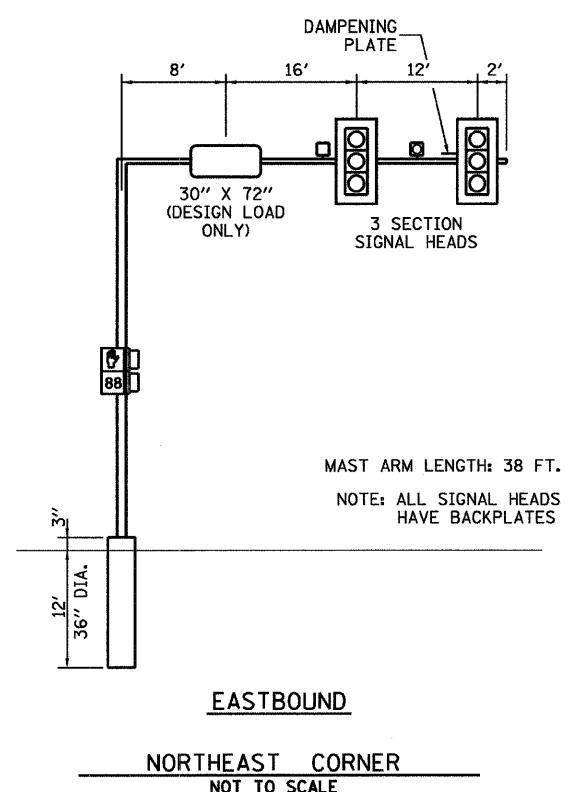

**LA SALLE STREET (IL 23 SB) / WASHINGTON STREET**

MAST ARM AND POLE SHALL BE DESIGNED FOR THE WORST CASE LOADING CONDITION WHEREBY ALL THE SIGNAL HEADS ARE LOCATED 2 FEET FURTHER OUT THAN POSITION SHOWN. HOWEVER THE INTENT IS THAT ALL SIGNAL HEADS BE CENTERED ABOVE THE LANES.

REVISIONS	
NAME	DATE

ILLINOIS DEPARTMENT OF TRANSPORTATION  
TRAFFIC SIGNAL DETAILS  
FAP 68 ALT (IL 23 SB)/LA SALLE ST  
AND WASHINGTON STREET  
SECTION 35,51 & 48 CS, 12)TS  
LA SALLE COUNTY

SCALE: VERT. \_\_\_\_\_  
HORIZ. \_\_\_\_\_  
DATE 11/08

DRAWN BY ARR  
CHECKED BY JLS