

TYPICAL ISLAND MARKING

TYPE OF MARKING	WIDTH OF LINE	PATTERN	COLOR	SPACING / REMARKS
CENTERLINE ON 2 LANE PAVEMENT	100 (4)	SKIP-DASH	YELLOW	3 m (10') LINE WITH 9 m (30') SPACE
CENTERLINE ON MULTI-LANE UNDIVIDED PAVEMENT	2 @ 100 (4)	SOLID	YELLOW	280 (11) C-C
NO PASSING ZONE LINES: FOR ONE DIRECTION FOR BOTH DIRECTIONS	100 (4) 2 @ 100 (4)	SOLID SOLID	YELLOW YELLOW	140 (5 1/2) C-C FROM SKIP-DASH CENTERLINE 280 (11) C-C OMIT SKIP-DASH CENTERLINE BETWEEN
LANE LINES	100 (4) 125 (5) ON FREEWAYS	SKIP-DASH SKIP-DASH	WHITE WHITE	3 m (10') LINE WITH 9 m (30') SPACE
DOTTED LINES (EXTENSIONS OF CENTER, LANE OR TURN LANE MARKINGS)	SAME AS LINE BEING EXTENDED	SKIP-DASH	SAME AS LINE BEING EXTENDED	600 (2') LINE WITH 1.8 m (6') SPACE
EDGE LINES	100 (4)	SOLID	YELLOW-LEFT WHITE-RIGHT	OUTLINE MOUNTABLE MEDIANS IN YELLOW; EDGE LINES ARE NOT USED NEXT TO BARRIER CURB
TURN LANE MARKINGS	150 (6) LINE; FULL SIZE LETTERS & SYMBOLS (2.4 m (8'))	SOLID	WHITE	SEE TYPICAL TURN LANE MARKING DETAIL
TWO WAY LEFT TURN MARKING	2 @ 100 (4) EACH DIRECTION	SKIP-DASH AND SOLID	YELLOW	3 m (10') LINE WITH 9 m (30') SPACE FOR SKIP-DASH; 140 (5 1/2) C-C BETWEEN SOLID LINE AND SKIP-DASH LINE
	2.4 m (8') LEFT ARROW	IN PAIRS	WHITE	SEE TYPICAL TWO-WAY LEFT TURN MARKING DETAIL
CROSSWALK LINES (PEDESTRIAN) A. DIAGONALS (BIKE & EQUESTRIAN) B. LONGITUDINAL BARS (SCHOOL)	2 @ 150 (6) 300 (12) @ 45° 300 (12) @ 90°	SOLID SOLID SOLID	WHITE WHITE WHITE	NOT LESS THAN 1.8 m (6') APART 600 (2') APART 600 (2') APART SEE TYPICAL CROSSWALK MARKING DETAILS.
STOP LINES	600 (24)	SOLID	WHITE	PLACE 1.2 m (4') IN ADVANCE OF AND PARALLEL TO CROSSWALK, IF PRESENT. OTHERWISE, PLACE AT DESIRED STOPPING POINT; PARALLEL TO CROSSROAD CENTERLINE, WHERE POSSIBLE
PAINTED MEDIANS	2 @ 100 (4) WITH 300 (12) DIAGONALS @ 45°	SOLID	YELLOW; TWO WAY TRAFFIC WHITE; ONE WAY TRAFFIC	280 (11) C-C FOR THE DOUBLE LINE SEE TYPICAL PAINTED MEDIAN MARKING.
GORE MARKING AND CHANNELIZING LINES	200 (8) WITH 300 (12) DIAGONALS @ 45°	SOLID	WHITE	DIAGONALS: 4.5 m (15') C-C (LESS THAN 50 km/h (30 MPH)) 6 m (20') C-C (50 km/h (30 MPH) TO 70 km/h (45 MPH)) 9 m (30') C-C (OVER 70 km/h (45 MPH))
RAILROAD CROSSING	600 (24) TRANSVERSE LINES; "RR" IS 1.8 m (6') LETTERS; 400 (16) LINE FOR "X"	SOLID	WHITE	SEE STATE STANDARD 780001 AREA OF: "R"=0.33m ² (3.6 SQ. FT.) EACH "X"=5.0 m ² (54.0 SQ. FT.)
SHOULDER DIAGONALS	300 (12) @ 45°	SOLID	WHITE - RIGHT YELLOW - LEFT	15 m (50') C-C (LESS THAN 50 km/h (30 MPH)) 25 m (75') C-C (50 km/h (30 MPH) TO 70 km/h (45 MPH)) 45 m (150') C-C (OVER 70 km/h (45 MPH))

FOR FURTHER DETAILS ON PAVEMENT MARKING REFER TO STANDARD SPECIFICATIONS FOR ROAD AND BRIDGE CONSTRUCTION AND STATE STANDARD 780001.

REVISIONS		ILLINOIS DEPARTMENT OF TRANSPORTATION
NAME	DATE	
		<p>DISTRICT ONE TYPICAL PAVEMENT MARKINGS OLD MONEE ROAD OVER THORN CREEK</p> <p>SCALE: VERT. N/A HORIZ. N/A DATE: 11/26/07</p> <p>DRAWN BY: MDJ CHECKED BY: DCJ</p>

SEC GROUP, INC.
Smith Engineering Consultants - SEC Automation - SEC Planning
4500 Prime Parkway, Mokena, IL 60450
t 815.285.1778 f 815.285.1781
www.secgroupinc.com e sgplanning@secgroupinc.com

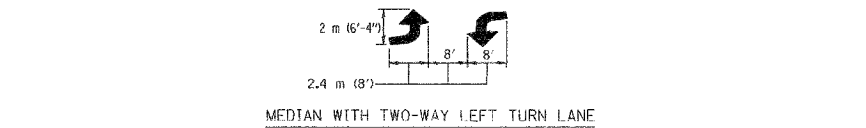
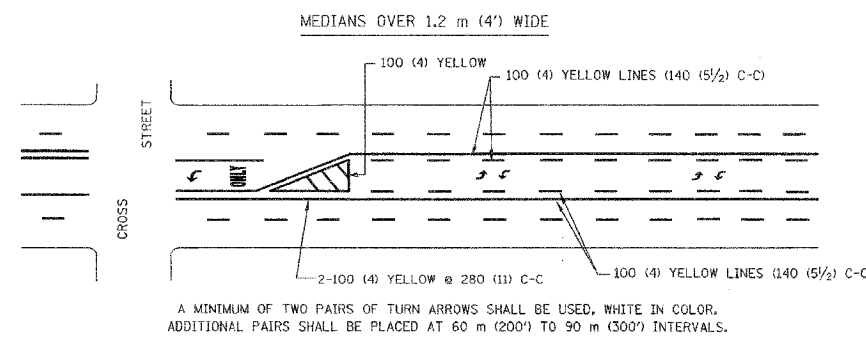
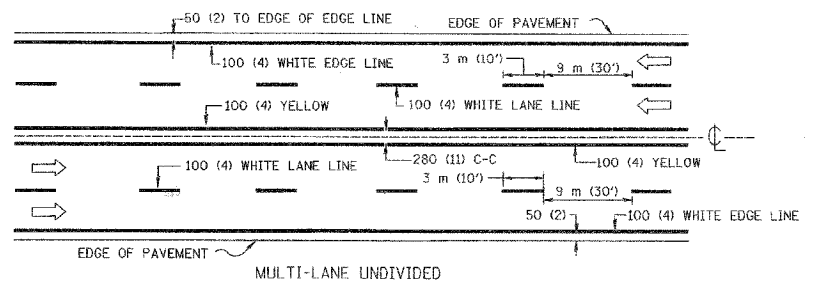

TYPICAL PAINTED MEDIAN MARKING

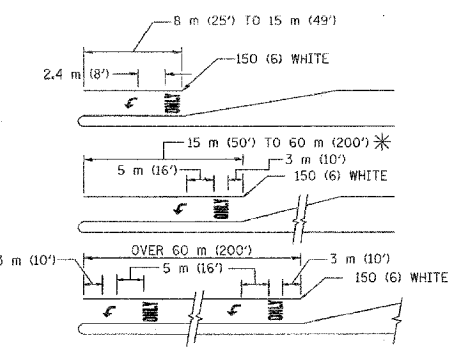

TYPICAL TURN LANE MARKING

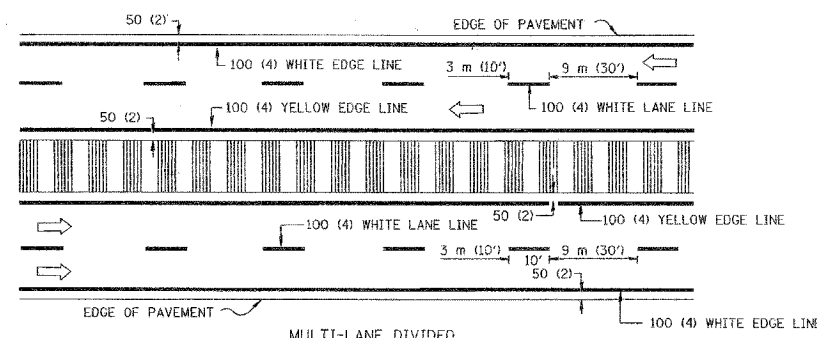

TYPICAL LANE AND EDGE LINE MARKING

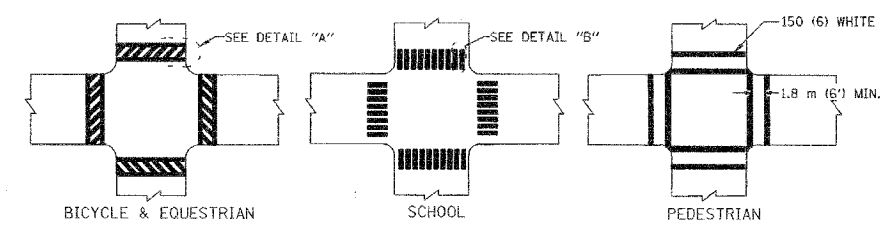

TYPICAL CROSSWALK MARKING

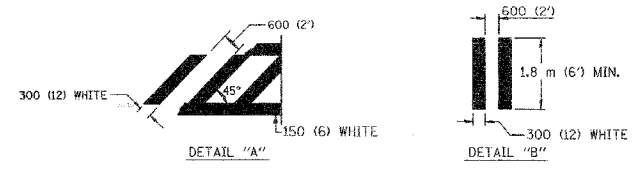

PLOT DATE = 11/21/2007
 FILE NAME = n:\pba\msh\2804\08189.wll old monee road\road\pavement\typical\p48189.dwg
 PLOT SCALE = 1:1
 USER NAME = wwood