

**ELEVATION OF BEAM AT END**

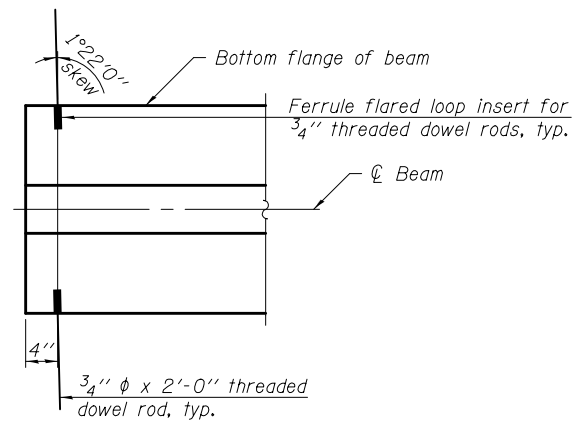

**PLAN OF BEAM AT END**

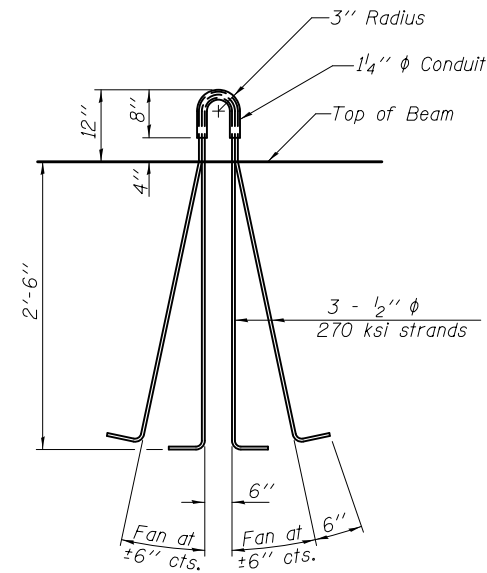

**LIFTING LOOP DETAIL**

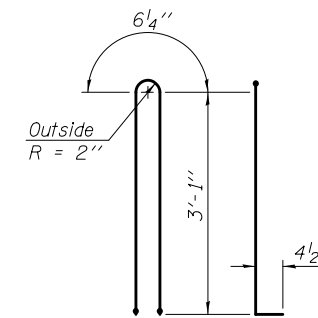

**BAR G1**

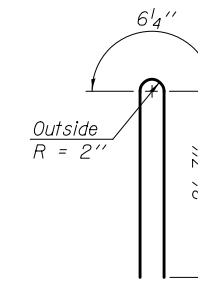

**BAR G2**

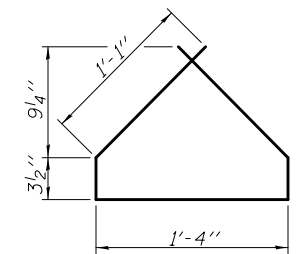

**BAR G4**

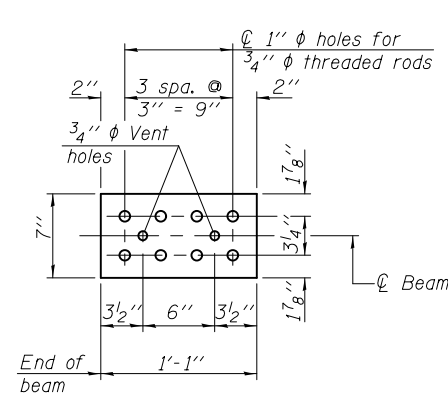

**TOP PLATE**

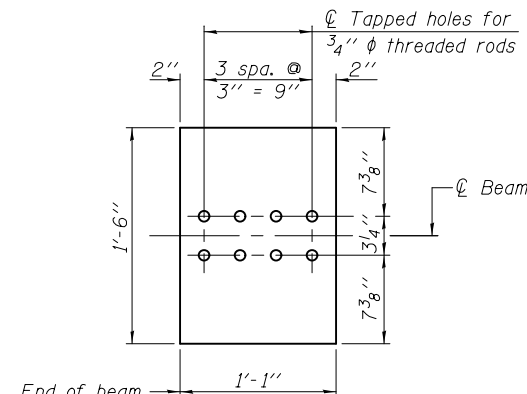

**BOTTOM PLATE**

**NOTES**

Inserts for 3/4"  $\phi$  threaded dowel rods, when specified, are to be two strut, ferrule type for interior beams and single ferrule, flared loop type for exterior beams. Prestressing steel shall be uncoated high strength, low relaxation 7-wire strand, Grade 270. The nominal diameter shall be 1/2" and the nominal cross-sectional area shall be 0.153 sq. in. A minimum 2 1/2"  $\phi$  lifting pin shall be used to engage the lifting loops during handling. The top and bottom plates shall be AASHTO M270 Grade 50. The bottom plates shall be galvanized according to AASHTO M111. Top plates and threaded rods need not be galvanized. Threaded rods shall be ASTM F 1554 Grade 55.

**BILL OF MATERIAL**

Item	Unit	Total
Furnishing and Erecting Precast Prestressed Concrete I-Beams, 36"	Ft.	218.5