

\*184-9-41A, HBK, BY, BY-1 Contract No 72541

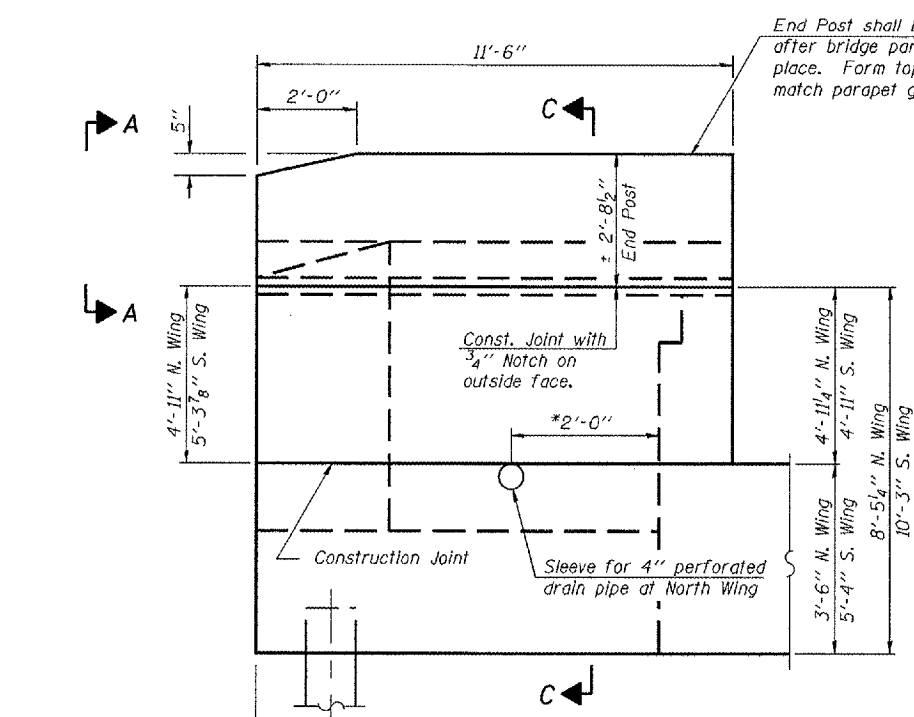

**WING WALL ELEVATION**  
Showing Dimensions

\*Dimension perpendicular to Back of Abutment

North Wing (Existing Pile) 5'-6 3/8"  
South Wing 2'-0"

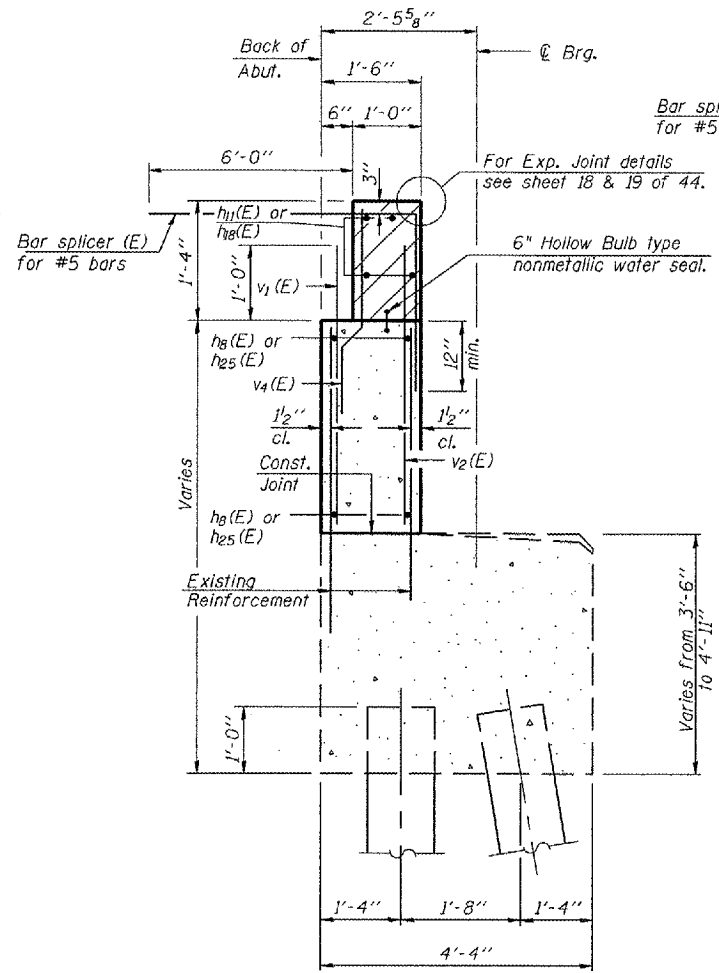

**SEC. THRU EXISTING ABUT.**

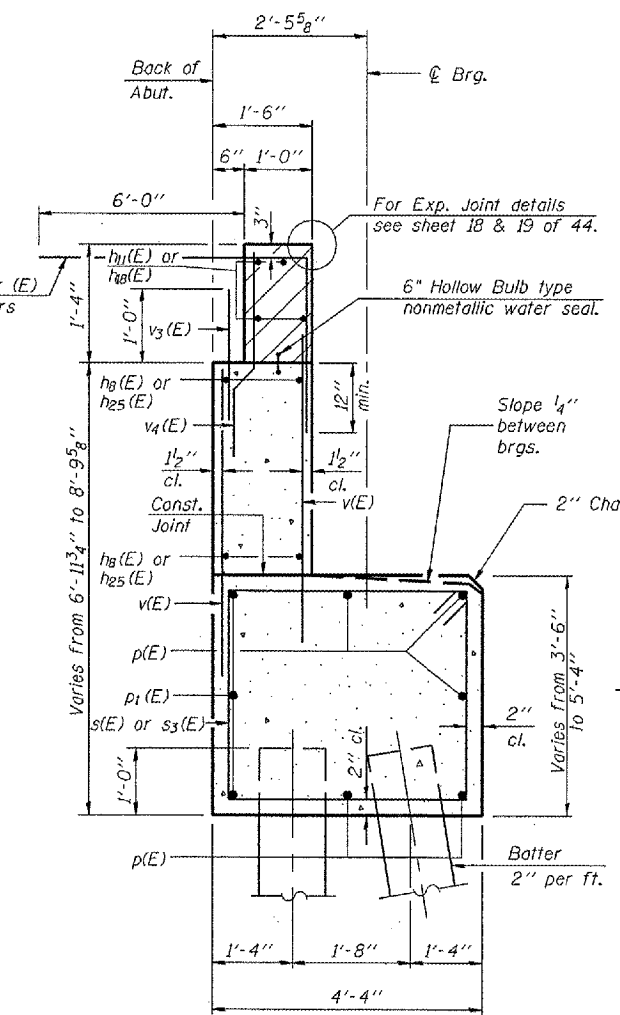

**SEC. THRU ABUT.**

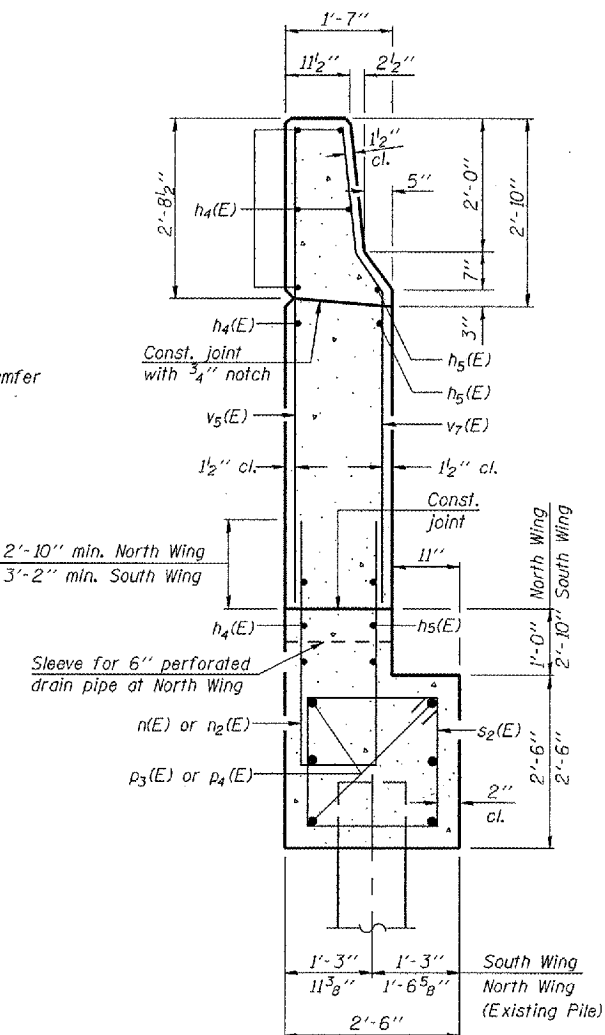

**SECTION C-C**

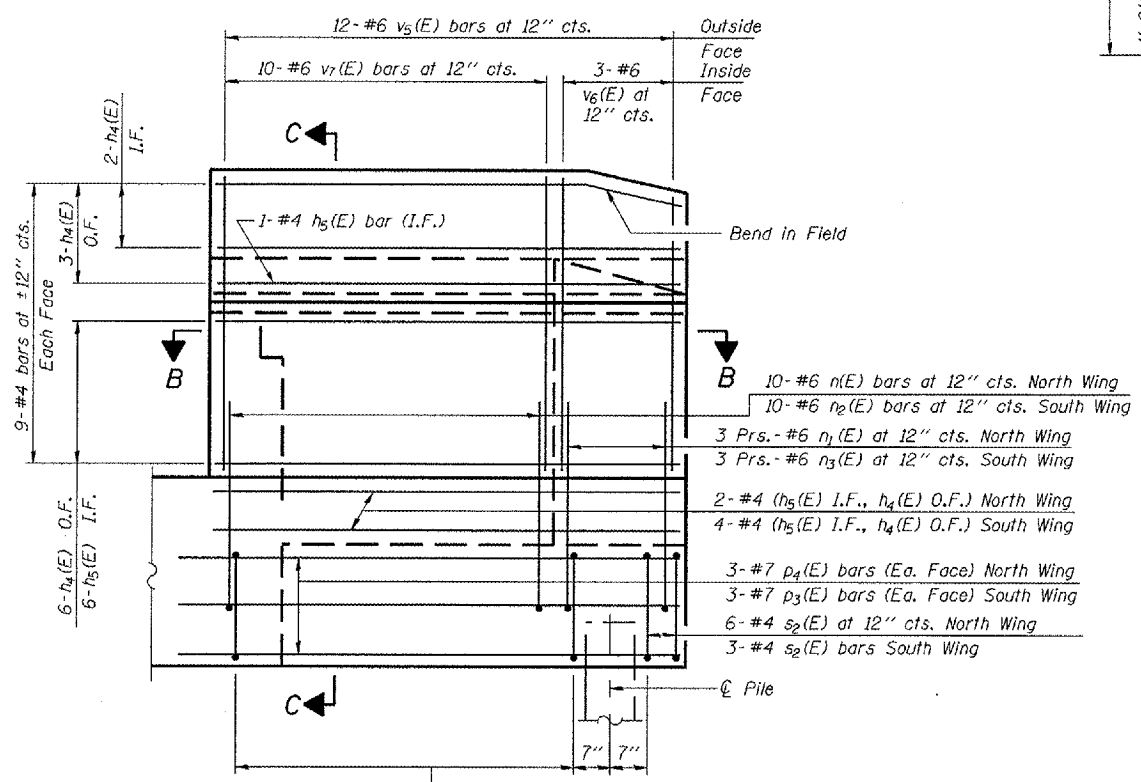

**WING WALL ELEVATION**  
Showing Reinforcement

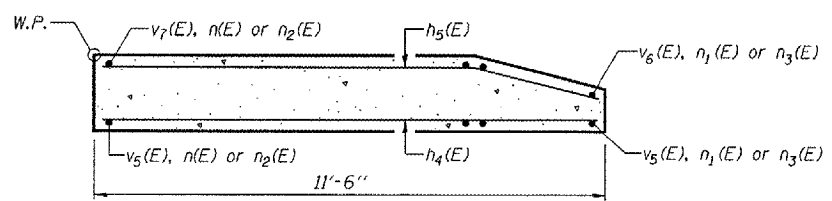

**SEC. B-B**

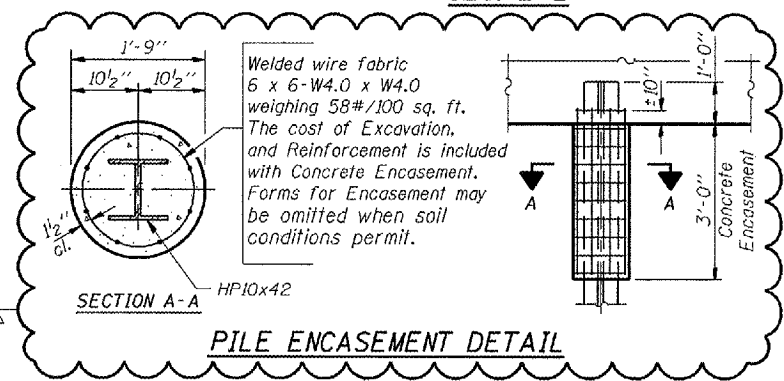

**PILE ENCASEMENT DETAIL**

**MIN. BAR LAPS**

- #4 Bar - 1'-8"
- #5 Bar - 2'-2"
- #6 Bar - 2'-7"
- #7 Bar - 3'-5"

Notes: Hatched area to be poured after superstructure forms have been removed. Quantity of concrete included with Concrete Superstructure. Space reinforcement in cap to miss anchor bolts. Pour steps monolithically with cap. Reinforcement bars designated (E) shall be epoxy coated. Quantity of concrete in end post included with Concrete Superstructure on sheet 16 of 44. Cost for sleeve shall be included with Concrete Structures.

Corporate License Number 184-001-084

**EASTBOUND-EAST ABUTMENT DETAILS**  
F.A.I. 72 OVER UNION PACIFIC RAILROAD  
SECTION (84-9-41A, HBK, BY, BY-1  
SANGAMON COUNTY  
STATION 608+51.98  
STR NO. 084-0074 EB - 084-0075 WB

© Copyright Hanson Professional Services Inc. SMS\_YEARS

**HANSON**  
96S2002B  
DATE: 01/12/06