

SECTION #	TOTAL SHEETS	SHEET NO.
06-00447-12-PV	50	6

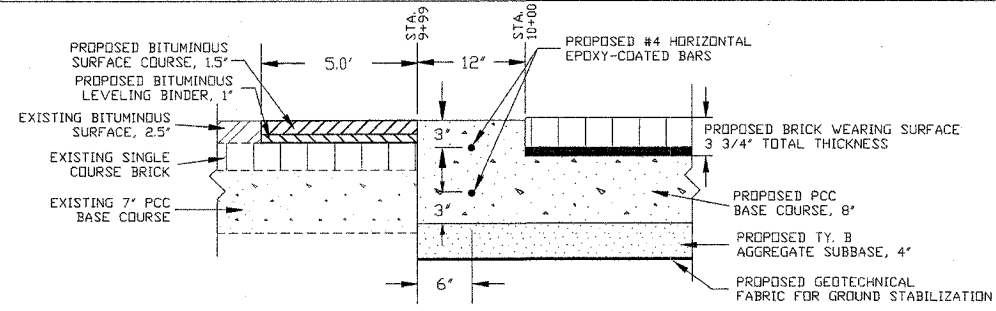

CONCRETE HEADER DETAIL
SOUTH END PROJECT
STATION 9+99 - 10+00

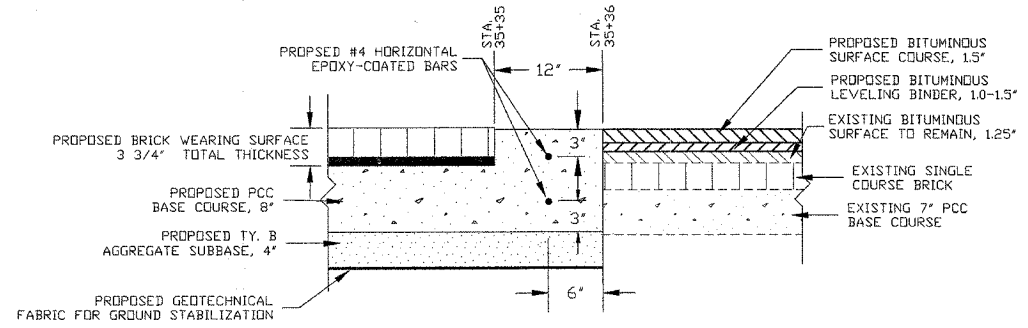

CONCRETE HEADER DETAIL
NORTH END PROJECT
STATION 35+35 - 35+36

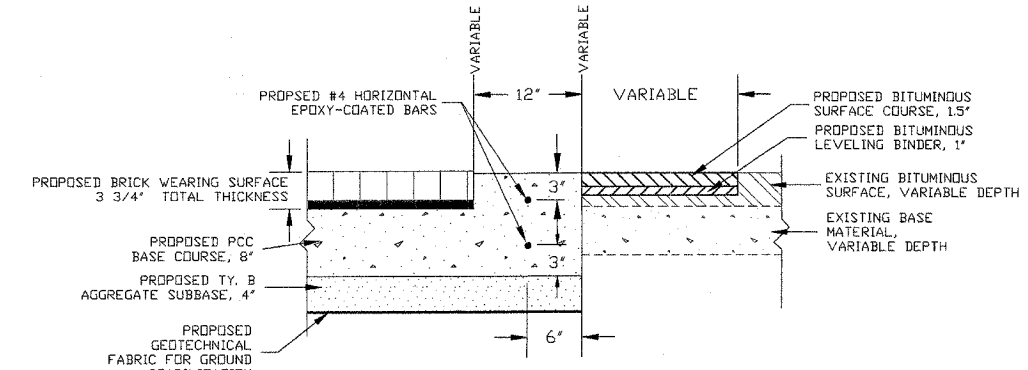

CONCRETE HEADER DETAIL
CONSTRUCTION JOINTS
VARIOUS SIDESTREET LOCATIONS

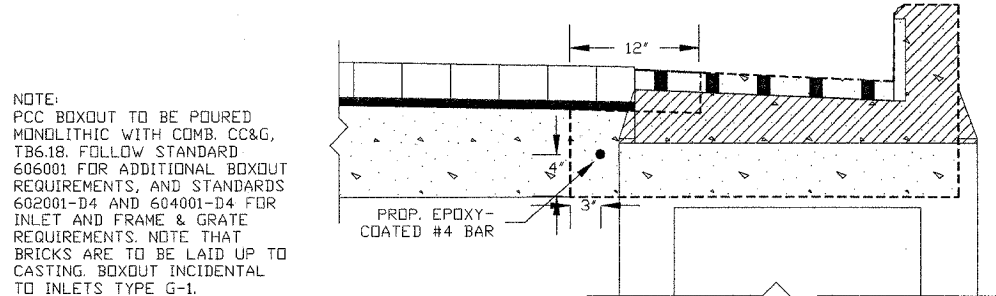

NOTE:
PCC BOXOUT TO BE POURED MONOLITHIC WITH COMB. CC&G, TB6.18. FOLLOW STANDARD 606001 FOR ADDITIONAL BOXOUT REQUIREMENTS, AND STANDARDS 602001-D4 AND 604001-D4 FOR INLET AND FRAME & GRATE REQUIREMENTS. NOTE THAT BRICKS ARE TO BE LAID UP TO CASTING BOXOUT INCIDENTAL TO INLETS TYPE G-1.

INLET TG-1 DETAIL
SECTION A-A
STATIONS 28+30 R&L

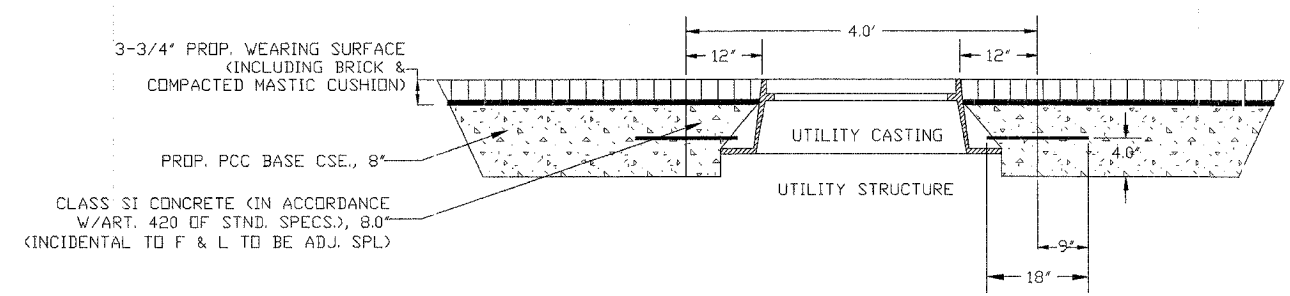
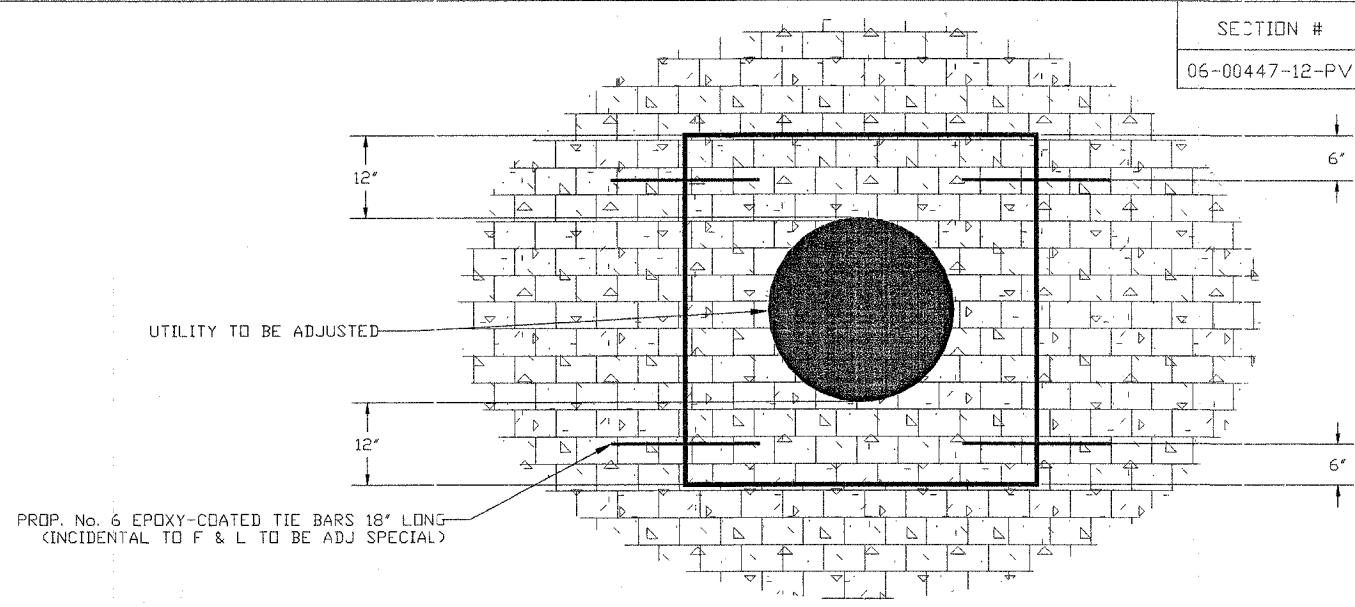

FRAME & LID ADJUST (SPECIAL) DETAIL
N.T.S.

NOTE:
PCC BOXOUT TO BE POURED AFTER COMPLETION OF PCC BASE COURSE, 8\"/>

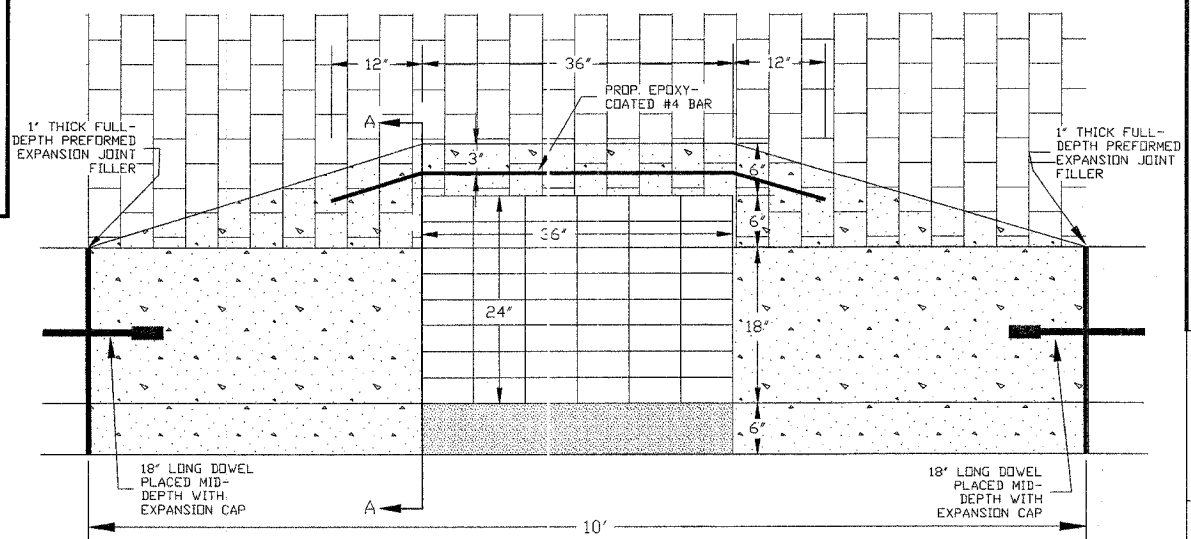

INLET TG-1 DETAIL
STATIONS 28+30 R&L

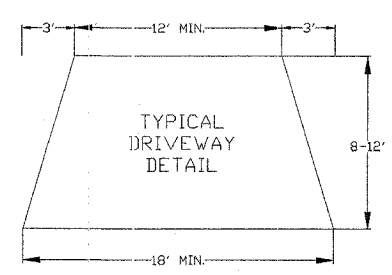

DETAILS

N. BROAD ST. BRICK RECONSTRUCTION
SECTION # 06-00447-12-PV
FAU ROUTE 6793
FEDERAL PROJECT # TE-00D4(097)
JOB # C-94-029-07
CONTRACT # 89456

