

RETURN WITH BID

State of _____)
) ss.
County of _____)

AFFIDAVIT

_____ (name of affiant), of _____,

_____, being first duly sworn upon oath, states as follows:

1. That I am the _____ (officer or position) of _____ (bidder) and have personal knowledge of the facts herein stated.
2. That, if selected under this proposal, _____ (bidder) will maintain a business office in the State of Illinois which will be located in _____ County, Illinois.
3. That this business office will serve as the primary place of employment for any persons employed in the construction contemplated by this proposal.
4. That this Affidavit is given as a requirement of state law as provided in Section 30-22(8) of the Illinois Procurement Code.

Signature

Print Name of Affiant

This instrument was acknowledged before me on the _____ day of _____, 20__ by _____.

Notary Public

(SEAL)

INSTRUCTIONS

ABOUT IDOT PROPOSALS: All proposals are potential bidding proposals. Each proposal contains all certifications and affidavits, a proposal signature sheet and a proposal bid bond.

PREQUALIFICATION

Any contractor who desires to become pre-qualified to bid on work advertised by IDOT must submit the properly completed pre-qualification forms to the Bureau of Construction no later than 4:30 p.m. prevailing time twenty-one days prior to the letting of interest. This pre-qualification requirement applies to first time contractors, contractors renewing expired ratings, contractors maintaining continuous pre-qualification or contractors requesting revised ratings. To be eligible to bid, existing pre-qualification ratings must be effective through the date of letting.

WHO CAN BID ?

Bids will be accepted from only those companies that request and receive written Authorization to Bid from IDOT's Central Bureau of Construction. This does not apply to Small Business Set-Asides.

REQUESTS FOR AUTHORIZATION TO BID

Contractors wanting to bid on items included in a particular letting must submit the properly completed "Request for Authorization to Bid/or Not For Bid Status" (BDE 124) and the ORIGINAL "Affidavit of Availability" (BC 57) to the proper office no later than 4:30 p.m. prevailing time, three (3) days prior to the letting date. This does not apply to Small Business Set-Asides.

WHAT CONSTITUTES WRITTEN AUTHORIZATION TO BID?: When a prospective prime bidder submits a "Request for Authorization to Bid/or Not For Bid Status"(BDE 124) he/she must indicate at that time which items are being requested For Bidding purposes. Only those items requested For Bidding will be analyzed. After the request has been analyzed, the bidder will be issued an **Authorization to Bid or Not for Bid Report**, approved by the Central Bureau of Construction that indicates which items have been approved For Bidding. If **Authorization to Bid** cannot be approved, the **Authorization to Bid or Not for Bid Report** will indicate the reason for denial.

ABOUT AUTHORIZATION TO BID: Firms that have not received an Authorization to Bid or Not For Bid Report within a reasonable time of complete and correct original document submittal should contact the department as to the status. Firms unsure as to authorization status should call the Prequalification Section of the Bureau of Construction at the number listed at the end of these instructions. These documents must be received three days before the letting date.

ADDENDA AND REVISIONS: It is the bidder's responsibility to determine which, if any, addenda or revisions pertain to any project they may be bidding. Failure to incorporate all relevant addenda or revisions may cause the bid to be declared unacceptable.

Each addendum or revision will be included with the Electronic Plans and Proposals. Addenda and revisions will also be placed on the Addendum/Revision Checklist and each subscription service subscriber will be notified by e-mail of each addendum and revision issued.

The Internet is the Department's primary way of doing business. The subscription server e-mails are an added courtesy the Department provides. It is suggested that bidders check IDOT's website at <http://www.dot.il.gov/desenv/deleft.html> before submitting final bid information.

IDOT IS NOT RESPONSIBLE FOR ANY E-MAIL FAILURES.

Addenda questions may be directed to the Plans and Contracts Office at (217)782-7806 or D&Econtracts@dot.il.gov

Technical questions about downloading these files may be directed to Tim Garman at (217)524-1642 or Timothy.Garman@illinois.gov.

BID SUBMITTAL GUIDELINES AND CHECKLIST

In an effort to eliminate confusion and standardize the bid submission process the Contracts Office has created the following guidelines and checklist for submitting bids.

This information has been compiled from questions received from contractors and from inconsistencies noted on submitted bids. If you have additional questions please refer to the contact information listed below.

ABOUT SUBMITTING BIDS: It is recommended that bidders deliver bid proposals in person to ensure they arrive at the proper location prior to the time specified for the receipt of bids. Any proposals received at the place of letting after the time specified will not be read.

STANDARD GUIDELINES FOR SUBMITTING BIDS

- All pages should be single sided.
- Use the Cover Page that is provided in the Bid Proposal (posted on the IDOT Web Site) as the first page of your submitted bid. This page has the Item number in the upper left-hand corner and lines provided for your company name and address in the upper right-hand corner.
- Do not use report covers, presentation folders or special bindings and do not staple multiple times on left side like a book. Use only 1 staple in the upper left hand corner. Make sure all elements of your bid are stapled together including the bid bond or guaranty check (if required).
- Do not include any certificates of eligibility, your authorization to bid, Addendum Letters or affidavit of availability.
- Do not include the Subcontractor Documentation with your bid (pages i – iii and pages a – g). This documentation is required only after you are awarded the contract.
- Use the envelope cover sheet (provided with the proposal) as the cover for the proposal envelope.
- Do not rely on overnight services to deliver your proposal prior to 10 AM on letting day. It will not be read if it is delivered after 10 AM.
- Do not submit your Substance Abuse Prevention Program (SAPP) with your bid. If you are awarded the contract this form is to be submitted to the district engineer at the pre-construction conference.

Use the following checklist to ensure completeness and the correct order in assembling your bid

Cover page followed by the Pay Items. If you are using special software or CBID to generate your schedule of prices, do not include the blank schedule of prices.

Page 4 (Item 9) – Check “YES” if you will use a subcontractor(s). Include the subcontractor(s) name, address and the dollar amount (if over \$25,000). If you will use subcontractor(s) but are uncertain who or the dollar amount; check “YES” but leave the lines blank.

After page 4, Insert affidavit for having an office in Illinois, your Cost Adjustments for Steel, Bituminous and Fuel (if applicable), and your State Board of Elections certificate of registration.

Page 10 (Paragraph J) – Check “YES” or “NO” whether your company has any business in Iran.

Page 10 (Paragraph K) – List the Union Local Name and number or certified training programs that you have in place. Do not include certificates with your bid. Keep the certificates in your office in case they are requested by IDOT.

Page 11 (Paragraph L) - Insert a copy of your State Board of Elections certificate of registration after page 4 of the bid proposal. Only include the page that has the date stamp on it. Do not include any other certificates or forms showing that you are an Illinois business.

Page 11 (Paragraph M) – Indicate if your company has hired a lobbyist in connection with the job for which you are submitting the bid proposal.

Page 12 (Paragraph C) – This is a work sheet to determine if a completed Form A is required. It is not part of the form and you do not need to make copies for each Form A that is filled out.

Pages 14-17 (Form A) – One Form A (4 pages) is required for each applicable person in your company. Copies of the Forms can be used and only need to be changed when the financial information changes. The certification signature and date must be original for each letting. Do not staple the forms together.

If you answered “NO” to all of the questions in Paragraph C (page 12), complete the first section (page 14) with your company information and then sign and date the Not Applicable statement on page 17.

Page 18 (Form B) - If you check “YES” to having other current or pending contracts it is acceptable to use the phrase, “See Affidavit of Availability on file”.

Page 20 (Workforce Projection) – Be sure to include the Duration of the Project. It is acceptable to use the phrase “Per Contract Specifications”.

Bid Bond – Submit your bid bond using the current Bid Bond Form provided in the proposal package. The Power of Attorney page should be stapled to the Bid Bond. If you are using an electronic bond, include your bid bond number on the form and attach the Proof of Insurance printed from the Surety 2000 Web Site.

Disadvantaged Business Utilization Plan and/or Good Faith Effort – The last item in your bid should be the DBE Utilization Plan (SBE 2026), DBE Participation Statement (SBE 2025) and supporting paperwork. If you have documentation for a Good Faith Effort, it should follow the SBE Forms.

The Bid Letting is now available in streaming Audio/Video from the IDOT Web Site. A link to the stream will be placed on the main page of the current letting on the day of the Letting. The stream will not begin until 10 AM. The actual reading of the bids does not begin until approximately 10:20 AM.

Following the Letting, the As-Read Tabulation of Bids will be posted by the end of the day. You will find the link on the main page of the current letting.

QUESTIONS: pre-letting up to execution of the contract

Contractor/Subcontractor pre-qualification -----217-782-3413
Small Business, Disadvantaged Business Enterprise (DBE) -----217-785-4611
Contracts, Bids, Letting process or Internet downloads-----217-785-0230
Estimates Unit -----217-785-3483

QUESTIONS: following contract execution

Including Subcontractor documentation, payments -----217-782-3413
Railroad Insurance -----217-785-0275

19

RETURN WITH BID

Proposal Submitted By
Name
Address
City

Letting March 9, 2012

NOTICE TO PROSPECTIVE BIDDERS

This proposal can be used for bidding purposes by only those companies that request and receive written AUTHORIZATION TO BID from IDOT's Central Bureau of Construction. This does not apply to Small Business Set-Asides.

BIDDERS NEED NOT RETURN THE ENTIRE PROPOSAL

Notice to Bidders, Specifications, Proposal, Contract and Contract Bond



**Illinois Department
of Transportation**

Springfield, Illinois 62764

**Contract No. 64H30
Various Counties
Section D2 GREENLIGHT 2012-2
Various Routes
District 2 Construction Funds**

PLEASE MARK THE APPROPRIATE BOX BELOW:

- A Bid Bond is included.
- A Cashier's Check or a Certified Check is included.

Plans Included
Herein

Prepared by

Checked by

S

(Printed by authority of the State of Illinois)

Page intentionally left blank

RETURN WITH BID



PROPOSAL

TO THE DEPARTMENT OF TRANSPORTATION

1. Proposal of _____

Taxpayer Identification Number (Mandatory) _____ a

for the improvement identified and advertised for bids in the Invitation for Bids as:

**Contract No. 64H30
Various Counties
Section D2 GREENLIGHT 2012-2
Various Routes
District 2 Construction Funds**

Upgrading traffic signal heads with LED lights at various locations in Carroll, Lee, Stephenson, Rock Island and Whiteside Counties.

2. The undersigned bidder will furnish all labor, material and equipment to complete the above described project in a good and workmanlike manner as provided in the contract documents provided by the Department of Transportation. This proposal will become part of the contract and the terms and conditions contained in the contract documents shall govern performance and payments.

RETURN WITH BID

3. **ASSURANCE OF EXAMINATION AND INSPECTION/WAIVER.** The undersigned further declares that he/she has carefully examined the proposal, plans, specifications, addenda, form of contract and contract bond, and special provisions, and that he/she has inspected in detail the site of the proposed work, and that he/she has familiarized themselves with all of the local conditions affecting the contract and the detailed requirements of construction, and understands that in making this proposal he/she waives all right to plead any misunderstanding regarding the same.
4. **EXECUTION OF CONTRACT AND CONTRACT BOND.** The undersigned further agrees to execute a contract for this work and present the same to the department within fifteen (15) days after the contract has been mailed to him/her. The undersigned further agrees that he/she and his/her surety will execute and present within fifteen (15) days after the contract has been mailed to him/her contract bond satisfactory to and in the form prescribed by the Department of Transportation, in the penal sum of the full amount of the contract, guaranteeing the faithful performance of the work in accordance with the terms of the contract.
5. **PROPOSAL GUARANTY.** Accompanying this proposal is either a bid bond on the department form, executed by a corporate surety company satisfactory to the department, or a proposal guaranty check consisting of a bank cashier's check or a properly certified check for not less than 5 per cent of the amount bid or for the amount specified in the following schedule:

<u>Amount of Bid</u>		<u>Proposal Guaranty</u>	<u>Amount of Bid</u>		<u>Proposal Guaranty</u>	
Up to	\$5,000	\$150	\$2,000,000	to	\$3,000,000	\$100,000
\$5,000	to \$10,000	\$300	\$3,000,000	to	\$5,000,000	\$150,000
\$10,000	to \$50,000	\$1,000	\$5,000,000	to	\$7,500,000	\$250,000
\$50,000	to \$100,000	\$3,000	\$7,500,000	to	\$10,000,000	\$400,000
\$100,000	to \$150,000	\$5,000	\$10,000,000	to	\$15,000,000	\$500,000
\$150,000	to \$250,000	\$7,500	\$15,000,000	to	\$20,000,000	\$600,000
\$250,000	to \$500,000	\$12,500	\$20,000,000	to	\$25,000,000	\$700,000
\$500,000	to \$1,000,000	\$25,000	\$25,000,000	to	\$30,000,000	\$800,000
\$1,000,000	to \$1,500,000	\$50,000	\$30,000,000	to	\$35,000,000	\$900,000
\$1,500,000	to \$2,000,000	\$75,000	over		\$35,000,000	\$1,000,000

Bank cashier's checks or properly certified checks accompanying proposals shall be made payable to the Treasurer, State of Illinois, when the state is awarding authority; the county treasurer, when a county is the awarding authority; or the city, village, or town treasurer, when a city, village, or town is the awarding authority.

If a combination bid is submitted, the proposal guaranties which accompany the individual proposals making up the combination will be considered as also covering the combination bid.

The amount of the proposal guaranty check is _____ \$(_____). If this proposal is accepted and the undersigned shall fail to execute a contract bond as required herein, it is hereby agreed that the amount of the proposal guaranty shall become the property of the State of Illinois, and shall be considered as payment of damages due to delay and other causes suffered by the State because of the failure to execute said contract and contract bond; otherwise, the bid bond shall become void or the proposal guaranty check shall be returned to the undersigned.

Attach Cashier's Check or Certified Check Here

In the event that one proposal guaranty check is intended to cover two or more proposals, the amount must be equal to the sum of the proposal guaranties which would be required for each individual proposal. If the guaranty check is placed in another proposal, state below where it may be found.

The proposal guaranty check will be found in the proposal for:

Item _____

Section No. _____

County _____

Mark the proposal cover sheet as to the type of proposal guaranty submitted.

RETURN WITH BID

6. **COMBINATION BIDS.** The undersigned further agrees that if awarded the contract for the sections contained in the following combination, he/she will perform the work in accordance with the requirements of each individual proposal comprising the combination bid specified in the schedule below, and that the combination bid shall be prorated against each section in proportion to the bid submitted for the same. If an error is found to exist in the gross sum bid for one or more of the individual sections included in a combination, the combination bid shall be corrected as provided in the specifications.

When a combination bid is submitted, the schedule below must be completed in each proposal comprising the combination.

If alternate bids are submitted for one or more of the sections comprising the combination, a combination bid must be submitted for each alternate.

Schedule of Combination Bids

Combination No.	Sections Included in Combination	Combination Bid	
		Dollars	Cents

7. **SCHEDULE OF PRICES.** The undersigned bidder submits herewith, in accordance with the rules and instructions, a schedule of prices for the items of work for which bids are sought. The unit prices bid are in U.S. dollars and cents, and all extensions and summations have been made. The bidder understands that the quantities appearing in the bid schedule are approximate and are provided for the purpose of obtaining a gross sum for the comparison of bids. If there is an error in the extension of the unit prices, the unit prices shall govern. Payment to the contractor awarded the contract will be made only for actual quantities of work performed and accepted or materials furnished according to the contract. The scheduled quantities of work to be done and materials to be furnished may be increased, decreased or omitted as provided elsewhere in the contract.

8. **AUTHORITY TO DO BUSINESS IN ILLINOIS.** Section 20-43 of the Illinois Procurement Code (30 ILCS 500/20-43) provides that a person (other than an individual acting as a sole proprietor) must be a legal entity authorized to do business in the State of Illinois prior to submitting the bid.

9. **The services of a subcontractor will or may be used.**

Check box Yes
 Check box No

For known subcontractors with subcontracts with an annual value of more than \$25,000, the contract shall include their name, address, and the dollar allocation for each subcontractor.

10. **EXECUTION OF CONTRACT:** The Department of Transportation will, in accordance with the rules governing Department procurements, execute the contract and shall be the sole entity having the authority to accept performance and make payments under the contract. Execution of the contract by the Chief Procurement Officer or the State Purchasing Officer is for approval of the procurement process and execution of the contract by the Department. Neither the Chief Procurement Officer nor the State Purchasing Officer shall be responsible for administration of the contract or determinations respecting performance or payment there under except as otherwise permitted in the Illinois Procurement Code.

ILLINOIS DEPARTMENT OF TRANSPORTATION
 SCHEDULE OF PRICES
 CONTRACT
 NUMBER -

64H30

State Job # - C-92-046-12
 PPS NBR - 0-00877-2002
 County Name - VARIOUS--
 Code - 0 - -
 District - 0 - -
 Section Number - D2 GREENLIGHT 2012-2

Project Number

Route
 VARIOUS

Item Number	Pay Item Description	Unit of Measure	Quantity	x	Unit Price	=	Total Price
X8570100	DISCONNECT SWITCH	EACH	1.000				
X8807670	SH LED RETROFIT	EACH	964.000				
X8809005	LED SF LENS COVER	EACH	260.000				
67100100	MOBILIZATION	L SUM	1.000				
70100310	TRAF CONT-PROT 701421	L SUM	1.000				
70102635	TR CONT & PROT 701701	L SUM	1.000				
85000300	MAIN EX TR SIG INSTAL	L SUM	1.000				
85700200	FAC T4 CAB	EACH	2.000				
86200200	UNINTER POWER SUP STD	EACH	6.000				
88040070	SH P LED 1F 3S BM	EACH	9.000				
88040090	SH P LED 1F 3S MAM	EACH	4.000				
88040120	SH P LED 1F 4S MAM	EACH	2.000				
88040150	SH P LED 1F 5S BM	EACH	2.000				
88040160	SH P LED 1F 5S MAM	EACH	4.000				
88102825	PED SH P LED 1F BM CT	EACH	110.000				

ILLINOIS DEPARTMENT OF TRANSPORTATION
 SCHEDULE OF PRICES
 CONTRACT
 NUMBER - 64H30

State Job # - C-92-046-12
 PPS NBR - 0-00877-2002
 County Name - VARIOUS--
 Code - 0 - -
 District - 0 - -
 Section Number - D2 GREENLIGHT 2012-2

Project Number

Route
 VARIOUS

Item Number	Pay Item Description	Unit of Measure	Quantity	x	Unit Price	=	Total Price
88200100	TS BACKPLATE	EACH	18.000				
88500500	IND L DET AMP	EACH	16.000				
88800100	PED PUSH-BUTTON	EACH	110.000				
89502100	REBUILD EX SIG HEAD	EACH	14.000				
89502375	REMOV EX TS EQUIP	EACH	26.000				

CONTRACT NUMBER

64H30

THIS IS THE TOTAL BID

\$ _____

NOTES:

- 1. Each PAY ITEM should have a UNIT PRICE and a TOTAL PRICE.**
- 2. The UNIT PRICE shall govern if no TOTAL PRICE is shown or if there is a discrepancy between the product of the UNIT PRICE multiplied by the QUANTITY.**
- 3. If a UNIT PRICE is omitted, the TOTAL PRICE will be divided by the QUANTITY in order to establish a UNIT PRICE.**
- 4. A bid may be declared UNACCEPTABLE if neither a unit price nor a total price is shown.**

RETURN WITH BID

STATE REQUIRED ETHICAL STANDARDS GOVERNING CONTRACT PROCUREMENT: ASSURANCES, CERTIFICATIONS AND DISCLOSURES

I. GENERAL

A. Article 50 of the Illinois Procurement Code establishes the duty of all State chief procurement officers, State purchasing officers, and their designees to maximize the value of the expenditure of public moneys in procuring goods, services, and contracts for the State of Illinois and to act in a manner that maintains the integrity and public trust of State government. In discharging this duty, they are charged by law to use all available information, reasonable efforts, and reasonable actions to protect, safeguard, and maintain the procurement process of the State of Illinois.

B. In order to comply with the provisions of Article 50 and to carry out the duty established therein, all bidders are to adhere to ethical standards established for the procurement process, and to make such assurances, disclosures and certifications required by law. Except as otherwise required in subsection III, paragraphs J-M, by execution of the Proposal Signature Sheet, the bidder indicates that each of the mandated assurances have been read and understood, that each certification is made and understood, and that each disclosure requirement has been understood and completed.

C. In addition to all other remedies provided by law, failure to comply with any assurance, failure to make any disclosure or the making of a false certification shall be grounds for the chief procurement officer to void the contract, or subcontract, and may result in the suspension or debarment of the bidder or subcontractor.

II. ASSURANCES

The assurances hereinafter made by the bidder are each a material representation of fact upon which reliance is placed should the Department enter into the contract with the bidder.

A. Conflicts of Interest

1. The Illinois Procurement Code provides in pertinent part:

Section 50-13. Conflicts of Interest.

(a) Prohibition. It is unlawful for any person holding an elective office in this State, holding a seat in the General Assembly, or appointed to or employed in any of the offices or agencies of state government and who receives compensation for such employment in excess of 60% of the salary of the Governor of the State of Illinois, or who is an officer or employee of the Capital Development Board or the Illinois Toll Highway Authority, or who is the spouse or minor child of any such person to have or acquire any contract, or any direct pecuniary interest in any contract therein, whether for stationery, printing, paper, or any services, materials, or supplies, that will be wholly or partially satisfied by the payment of funds appropriated by the General Assembly of the State of Illinois or in any contract of the Capital Development Board or the Illinois Toll Highway authority.

(b) Interests. It is unlawful for any firm, partnership, association or corporation, in which any person listed in subsection (a) is entitled to receive (i) more than 7 1/2% of the total distributable income or (ii) an amount in excess of the salary of the Governor, to have or acquire any such contract or direct pecuniary interest therein.

(c) Combined interests. It is unlawful for any firm, partnership, association, or corporation, in which any person listed in subsection (a) together with his or her spouse or minor children is entitled to receive (i) more than 15%, in the aggregate, of the total distributable income or (ii) an amount in excess of 2 times the salary of the Governor, to have or acquire any such contract or direct pecuniary interest therein.

(d) Securities. Nothing in this Section invalidates the provisions of any bond or other security previously offered or to be offered for sale or sold by or for the State of Illinois.

(e) Prior interests. This Section does not affect the validity of any contract made between the State and an officer or employee of the State or member of the General Assembly, his or her spouse, minor child or any combination of those persons if that contract was in existence before his or her election or employment as an officer, member, or employee. The contract is voidable, however, if it cannot be completed within 365 days after the officer, member, or employee takes office or is employed.

The current salary of the Governor is \$177,412.00. Sixty percent of the salary is \$106,447.20.

RETURN WITH BID

2. The bidder assures the Department that the award and execution of the contract would not cause a violation of Section 50-13, or that an effective exemption has been issued by the Board of Ethics to any individual subject to the Section 50-13 prohibitions pursuant to the provisions of Section 50-20 of the Code and Executive Order Number 3 (1998). Information concerning the exemption process is available from the Department upon request.

B. Negotiations

1. The Illinois Procurement Code provides in pertinent part:

Section 50-15. Negotiations.

(a) It is unlawful for any person employed in or on a continual contractual relationship with any of the offices or agencies of State government to participate in contract negotiations on behalf of that office or agency with any firm, partnership, association, or corporation with whom that person has a contract for future employment or is negotiating concerning possible future employment.

2. The bidder assures the Department that the award and execution of the contract would not cause a violation of Section 50-15, and that the bidder has no knowledge of any facts relevant to the kinds of acts prohibited therein.

C. Inducements

1. The Illinois Procurement Code provides:

Section 50-25. Inducement. Any person who offers or pays any money or other valuable thing to any person to induce him or her not to bid for a State contract or as recompense for not having bid on a State contract is guilty of a Class 4 felony. Any person who accepts any money or other valuable thing for not bidding for a State contract or who withholds a bid in consideration of the promise for the payment of money or other valuable thing is guilty of a Class 4 felony.

2. The bidder assures the Department that the award and execution of the contract would not cause a violation of Section 50-25, and that the bidder has no knowledge of any facts relevant to the kinds of acts prohibited therein.

D. Revolving Door Prohibition

1. The Illinois Procurement Code provides:

Section 50-30. Revolving door prohibition. Chief procurement officers, State purchasing officers, procurement compliance monitors, their designees whose principal duties are directly related to State procurement, and executive officers confirmed by the Senate are expressly prohibited for a period of 2 years after terminating an affected position from engaging in any procurement activity relating to the State agency most recently employing them in an affected position for a period of at least 6 months. The prohibition includes, but is not limited to: lobbying the procurement process; specifying; bidding; proposing bid, proposal, or contract documents; on their own behalf or on behalf of any firm, partnership, association, or corporation. This Section applies only to persons who terminate an affected position on or after January 15, 1999.

2. The bidder assures the Department that the award and execution of the contract would not cause a violation of Section 50-30, and that the bidder has no knowledge of any facts relevant to the kinds of acts prohibited therein.

E. Reporting Anticompetitive Practices

1. The Illinois Procurement Code provides:

Section 50-40. Reporting anticompetitive practices. When, for any reason, any vendor, bidder, contractor, chief procurement officer, State purchasing officer, designee, elected official, or State employee suspects collusion or other anticompetitive practice among any bidders, offerors, contractors, proposers, or employees of the State, a notice of the relevant facts shall be transmitted to the Attorney General and the chief procurement officer.

2. The bidder assures the Department that it has not failed to report any relevant facts concerning the practices addressed in Section 50-40 which may involve the contract for which the bid is submitted.

F. Confidentiality

1. The Illinois Procurement Code provides:

Section 50-45. Confidentiality. Any chief procurement officer, State purchasing officer, designee, or executive officer who willfully uses or allows the use of specifications, competitive bid documents, proprietary competitive information, proposals, contracts, or selection information to compromise the fairness or integrity of the procurement, bidding, or contract process shall be subject to immediate dismissal, regardless of the Personnel code, any contract, or any collective bargaining agreement, and may in addition be subject to criminal prosecution.

2. The bidder assures the Department that it has no knowledge of any fact relevant to the practices addressed in Section 50-45 which may involve the contract for which the bid is submitted.

RETURN WITH BID

G. Insider Information

1. The Illinois Procurement Act provides:

Section 50-50. Insider information. It is unlawful for any current or former elected or appointed State official or State employee to knowingly use confidential information available only by virtue of that office or employment for actual or anticipated gain for themselves or another person.

2. The bidder assures the Department that it has no knowledge of any facts relevant to the practices addressed in Section 50-50 which may involve the contract for which the bid is submitted.

III. CERTIFICATIONS

The certifications hereinafter made by the bidder are each a material representation of fact upon which reliance is placed should the Department enter into the contract with the bidder. Section 50-2 of the Illinois Procurement Code provides that every person that has entered into a multi-year contract and every subcontractor with a multi-year subcontract shall certify, by July 1 of each fiscal year covered by the contract after the initial fiscal year, to the responsible chief procurement officer whether it continues to satisfy the requirements of Article 50 pertaining to the eligibility for a contract award. If a contractor or subcontractor is not able to truthfully certify that it continues to meet all requirements, it shall provide with its certification a detailed explanation of the circumstances leading to the change in certification status. A contractor or subcontractor that makes a false statement material to any given certification required under Article 50 is, in addition to any other penalties or consequences prescribed by law, subject to liability under the Whistleblower Reward and Protection Act for submission of a false claim.

A. Bribery

1. The Illinois Procurement Code provides:

Section 50-5. Bribery.

(a) Prohibition. No person or business shall be awarded a contract or subcontract under this Code who:

(1) has been convicted under the laws of Illinois or any other state of bribery or attempting to bribe an officer or employee of the State of Illinois or any other state in that officer's or employee's official capacity; or

(2) has made an admission of guilt of that conduct that is a matter of record but has not been prosecuted for that conduct.

(b) Businesses. No business shall be barred from contracting with any unit of State or local government, or subcontracting under such a contract, as a result of a conviction under this Section of any employee or agent of the business if the employee or agent is no longer employed by the business and:

(1) the business has been finally adjudicated not guilty; or

(2) the business demonstrates to the governmental entity with which it seeks to contract, or which is signatory to the contract which the subcontract relates, and that entity finds that the commission of the offense was not authorized, requested, commanded, or performed by a director, officer, or high managerial agent on behalf of the business as provided in paragraph (2) of subsection (a) of Section 5-4 of the Criminal Code of 1961.

(c) Conduct on behalf of business. For purposes of this Section, when an official, agent, or employee of a business committed the bribery or attempted bribery on behalf of the business and in accordance with the direction or authorization of a responsible official of the business, the business shall be chargeable with the conduct.

(d) Certification. Every bid submitted to and contract executed by the State, and every subcontract subject to Section 20-120 of the Procurement Code shall contain a certification by the contractor or the subcontractor, respectively, that the contractor or subcontractor is not barred from being awarded a contract or subcontract under this Section and acknowledges that the chief procurement officer may declare the related contract void if any certifications required by this Section are false. A contractor who makes a false statement, material to the certification, commits a Class 3 felony.

2. The contractor or subcontractor certifies that it is not barred from being awarded a contract under Section 50.5.

B. Felons

1. The Illinois Procurement Code provides:

Section 50-10. Felons. Unless otherwise provided, no person or business convicted of a felony shall do business with the State of Illinois or any State agency, or enter into a subcontract, from the date of conviction until 5 years after the date of completion of the sentence for that felony, unless no person held responsible by a prosecutorial office for the facts upon which the conviction was based continues to have any involvement with the business.

2. Certification. Every bid submitted to and contract executed by the State and every subcontract subject to Section 20-120 of the Procurement Code shall contain a certification by the bidder or contractor or subcontractor, respectively, that the bidder, contractor, or subcontractor is not barred from being awarded a contract or subcontract under this Section and acknowledges that the chief procurement officer may declare the related contract void if any of the certifications required by this Section are false.

RETURN WITH BID

C. Debt Delinquency

1. The Illinois Procurement Code provides:

Section 50-11 and 50-12. Debt Delinquency.

The contractor or bidder or subcontractor, respectively, certifies that it, or any affiliate, is not barred from being awarded a contract or subcontract under the Procurement Code. Section 50-11 prohibits a person from entering into a contract with a State agency, or entering into a subcontract, if it knows or should know that it, or any affiliate, is delinquent in the payment of any debt to the State as defined by the Debt Collection Board. Section 50-12 prohibits a person from entering into a contract with a State agency, or entering into a subcontract, if it, or any affiliate, has failed to collect and remit Illinois Use Tax on all sales of tangible personal property into the State of Illinois in accordance with the provisions of the Illinois Use Tax Act. The bidder or contractor or subcontractor, respectively, further acknowledges that the chief procurement officer may declare the related contract void if this certification is false or if the bidder, contractor, or subcontractor, or any affiliate, is determined to be delinquent in the payment of any debt to the State during the term of the contract.

D. Prohibited Bidders, Contractors and Subcontractors

1. The Illinois Procurement Code provides:

Section 50-10.5 and 50-60(c). Prohibited bidders, contractors and subcontractors.

The bidder or contractor or subcontractor, respectively, certifies in accordance with 30 ILCS 500/50-10.5 that no officer, director, partner or other managerial agent of the contracting business has been convicted of a felony under the Sarbanes-Oxley Act of 2002 or a Class 3 or Class 2 felony under the Illinois Securities Law of 1953 or if in violation of Subsection (c) for a period of five years from the date of conviction. Every bid submitted to and contract executed by the State and every subcontract subject to Section 20-120 of the Procurement Code shall contain a certification by the bidder, contractor, or subcontractor, respectively, that the bidder, contractor, or subcontractor is not barred from being awarded a contract or subcontract under this Section and acknowledges that the chief procurement officer shall declare the related contract void if any of the certifications completed pursuant to this Section are false.

E. Section 42 of the Environmental Protection Act

The bidder or contractor or subcontractor, respectively, certifies in accordance with 30 ILCS 500/50-12 that the bidder, contractor, or subcontractor, is not barred from being awarded a contract or entering into a subcontract under this Section which prohibits the bidding on or entering into contracts with the State of Illinois or a State agency, or entering into any subcontract, that is subject to the Procurement Code by a person or business found by a court or the Pollution Control Board to have committed a willful or knowing violation of Section 42 of the Environmental Protection Act for a period of five years from the date of the order. The bidder or contractor or subcontractor, respectively, acknowledges that the chief procurement officer may declare the contract void if this certification is false.

F. Educational Loan

1. Section 3 of the Educational Loan Default Act provides:

§ 3. No State agency shall contract with an individual for goods or services if that individual is in default, as defined in Section 2 of this Act, on an educational loan. Any contract used by any State agency shall include a statement certifying that the individual is not in default on an educational loan as provided in this Section.

2. The bidder, if an individual as opposed to a corporation, partnership or other form of business organization, certifies that the bidder is not in default on an educational loan as provided in Section 3 of the Act.

G. Bid-Rigging/Bid Rotating

1. Section 33E-11 of the Criminal Code of 1961 provides:

§ 33E-11. (a) Every bid submitted to and public contract executed pursuant to such bid by the State or a unit of local government shall contain a certification by the prime contractor that the prime contractor is not barred from contracting with any unit of State or local government as a result of a violation of either Section 33E-3 or 33E-4 of this Article. The State and units of local government shall provide the appropriate forms for such certification.

- (b) A contractor who makes a false statement, material to the certification, commits a Class 3 felony.

A violation of Section 33E-3 would be represented by a conviction of the crime of bid-rigging which, in addition to Class 3 felony sentencing, provides that any person convicted of this offense or any similar offense of any state or the United States which contains the same elements as this offense shall be barred for 5 years from the date of conviction from contracting with any unit of State or local government. No corporation shall be barred from contracting with any unit of State or local government as a result of a conviction under this Section of any employee or agent of such corporation if the employee so convicted is no longer employed by the corporation and: (1) it has been finally adjudicated not guilty or (2) if it demonstrates to the governmental entity with which it seeks to contract and that entity finds that the commission of the offense was neither authorized, requested, commanded, nor performed by a director, officer or a high managerial agent in behalf of the corporation.

RETURN WITH BID

A violation of Section 33E-4 would be represented by a conviction of the crime of bid-rotating which, in addition to Class 2 felony sentencing, provides that any person convicted of this offense or any similar offense of any state or the United States which contains the same elements as this offense shall be permanently barred from contracting with any unit of State or local government. No corporation shall be barred from contracting with any unit of State or local government as a result of a conviction under this Section of any employee or agent of such corporation if the employee so convicted is no longer employed by the corporation and: (1) it has been finally adjudicated not guilty or (2) if it demonstrates to the governmental entity with which it seeks to contract and that entity finds that the commission of the offense was neither authorized, requested, commanded, nor performed by a director, officer or a high managerial agent in behalf of the corporation.

2. The bidder certifies that it is not barred from contracting with the Department by reason of a violation of either Section 33E-3 or Section 33E-4.

H. International Anti-Boycott

1. Section 5 of the International Anti-Boycott Certification Act provides:

§ 5. State contracts. Every contract entered into by the State of Illinois for the manufacture, furnishing, or purchasing of supplies, material, or equipment or for the furnishing of work, labor, or services, in an amount exceeding the threshold for small purchases according to the purchasing laws of this State or \$10,000.00, whichever is less, shall contain certification, as a material condition of the contract, by which the contractor agrees that neither the contractor nor any substantially-owned affiliated company is participating or shall participate in an international boycott in violation of the provisions of the U.S. Export Administration Act of 1979 or the regulations of the U.S. Department of Commerce promulgated under that Act.

2. The bidder makes the certification set forth in Section 5 of the Act.

I. Drug Free Workplace

1. The Illinois "Drug Free Workplace Act" applies to this contract and it is necessary to comply with the provisions of the "Act" if the contractor is a corporation, partnership, or other entity (including a sole proprietorship) which has 25 or more employees.

2. The bidder certifies that if awarded a contract in excess of \$5,000 it will provide a drug free workplace by:

(a) Publishing a statement notifying employees that the unlawful manufacture, distribution, dispensation, possession or use of a controlled substance, including cannabis, is prohibited in the contractor's workplace; specifying the actions that will be taken against employees for violations of such prohibition; and notifying the employee that, as a condition of employment on such contract, the employee shall abide by the terms of the statement, and notify the employer of any criminal drug statute conviction for a violation occurring in the workplace no later than five (5) days after such conviction.

(b) Establishing a drug free awareness program to inform employees about the dangers of drug abuse in the workplace; the contractor's policy of maintaining a drug free workplace; any available drug counseling, rehabilitation, and employee assistance programs; and the penalties that may be imposed upon employees for drug violations.

(c) Providing a copy of the statement required by subparagraph (1) to each employee engaged in the performance of the contract and to post the statement in a prominent place in the workplace.

(d) Notifying the Department within ten (10) days after receiving notice from an employee or otherwise receiving actual notice of the conviction of an employee for a violation of any criminal drug statute occurring in the workplace.

(e) Imposing or requiring, within 30 days after receiving notice from an employee of a conviction or actual notice of such a conviction, an appropriate personnel action, up to and including termination, or the satisfactory participation in a drug abuse assistance or rehabilitation program approved by a federal, state or local health, law enforcement or other appropriate agency.

(f) Assisting employees in selecting a course of action in the event drug counseling, treatment, and rehabilitation is required and indicating that a trained referral team is in place.

(g) Making a good faith effort to continue to maintain a drug free workplace through implementation of the actions and efforts stated in this certification.

RETURN WITH BID

J. Disclosure of Business Operations in Iran

Section 50-36 of the Illinois Procurement Code, 30ILCS 500/50-36 provides that each bid, offer, or proposal submitted for a State contract shall include a disclosure of whether or not the Company acting as the bidder, offeror, or proposing entity, or any of its corporate parents or subsidiaries, within the 24 months before submission of the bid, offer, or proposal had business operations that involved contracts with or provision of supplies or services to the Government of Iran, companies in which the Government of Iran has any direct or indirect equity share, consortiums or projects commissioned by the Government of Iran, or companies involved in consortiums or projects commissioned by the Government of Iran and either of the following conditions apply:

- (1) More than 10% of the Company's revenues produced in or assets located in Iran involve oil-related activities or mineral-extraction activities; less than 75% of the Company's revenues produced in or assets located in Iran involve contracts with or provision of oil-related or mineral-extraction products or services to the Government of Iran or a project or consortium created exclusively by that government; and the Company has failed to take substantial action.
(2) The Company has, on or after August 5, 1996, made an investment of \$20 million or more, or any combination of investments of at least \$10 million each that in the aggregate equals or exceeds \$20 million in any 12-month period, which directly or significantly contributes to the enhancement of Iran's ability to develop petroleum resources of Iran.

The terms "Business operations", "Company", "Mineral-extraction activities", "Oil-related activities", "Petroleum resources", and "Substantial action" are all defined in the Code.

Failure to make the disclosure required by the Code shall cause the bid, offer or proposal to be considered not responsive. The disclosure will be considered when evaluating the bid, offer, or proposal or awarding the contract. The name of each Company disclosed as doing business or having done business in Iran will be provided to the State Comptroller.

Check the appropriate statement:

- /___/ Company has no business operations in Iran to disclose.
/___/ Company has business operations in Iran as disclosed the attached document.

K. Apprenticeship and Training Certification (Does not apply to federal aid projects)

In accordance with the provisions of Section 30-22 (6) of the Illinois Procurement Code, the bidder certifies that it is a participant, either as an individual or as part of a group program, in the approved apprenticeship and training programs applicable to each type of work or craft that the bidder will perform with its own forces. The bidder further certifies for work that will be performed by subcontract that each of its subcontractors submitted for approval either (a) is, at the time of such bid, participating in an approved, applicable apprenticeship and training program; or (b) will, prior to commencement of performance of work pursuant to this contract, begin participation in an approved apprenticeship and training program applicable to the work of the subcontract. The Department, at any time before or after award, may require the production of a copy of each applicable Certificate of Registration issued by the United States Department of Labor evidencing such participation by the contractor and any or all of its subcontractors. Applicable apprenticeship and training programs are those that have been approved and registered with the United States Department of Labor. The bidder shall list in the space below, the official name of the program sponsor holding the Certificate of Registration for all of the types of work or crafts in which the bidder is a participant and that will be performed with the bidder's forces. Types of work or craft work that will be subcontracted shall be included and listed as subcontract work. The list shall also indicate any type of work or craft job category that does not have an applicable apprenticeship or training program. The bidder is responsible for making a complete report and shall make certain that each type of work or craft job category that will be utilized on the project as reported on the Construction Employee Workforce Projection (Form BC-1256) and returned with the bid is accounted for and listed.

Three horizontal lines for listing program sponsors.

The requirements of this certification and disclosure are a material part of the contract, and the contractor shall require this certification provision to be included in all approved subcontracts. In order to fulfill this requirement, it shall not be necessary that an applicable program sponsor be currently taking or that it will take applications for apprenticeship, training or employment during the performance of the work of this contract.

TO BE RETURNED WITH BID

L. Political Contributions and Registration with the State Board of Elections

Sections 20-160 and 50-37 of the Illinois Procurement Code regulate political contributions from business entities and any affiliated entities or affiliated persons bidding on or contracting with the state. Generally under Section 50-37, any business entity, and any affiliated entity or affiliated person of the business entity, whose current year contracts with all state agencies exceed an awarded value of \$50,000, are prohibited from making any contributions to any political committees established to promote the candidacy of the officeholder responsible for the awarding of the contracts or any other declared candidate for that office for the duration of the term of office of the incumbent officeholder or a period 2 years after the termination of the contract, whichever is longer. Any business entity and affiliated entities or affiliated persons whose state contracts in the current year do not exceed an awarded value of \$50,000, but whose aggregate pending bids and proposals on state contracts exceed \$50,000, either alone or in combination with contracts not exceeding \$50,000, are prohibited from making any political contributions to any political committee established to promote the candidacy of the officeholder responsible for awarding the pending contract during the period beginning on the date the invitation for bids or request for proposals is issued and ending on the day after the date of award or selection if the entity was not awarded or selected. Section 20-160 requires certification of registration of affected business entities in accordance with procedures found in Section 9-35 of The Election Code.

By submission of a bid, the contractor business entity acknowledges and agrees that it has read and understands Sections 20-160 and 50-37 of the Illinois Procurement Code, and that it makes the following certification:

The undersigned business entity certifies that it has registered as a business with the State Board of Elections and acknowledges a continuing duty to update the registration in accordance with the above referenced statutes. A copy of the certificate of registration shall be submitted with the bid. The bidder is cautioned that the Department will not award a contract without submission of the certificate of registration.

These requirements and compliance with the above referenced statutory sections are a material part of the contract, and any breach thereof shall be cause to void the contract under Section 50-60 of the Illinois Procurement Code. This provision does not apply to Federal-aid contracts.

M. Lobbyist Disclosure

Section 50-38 of the Illinois Procurement Code requires that any bidder or offeror on a State contract that hires a person required to register under the Lobbyist Registration Act to assist in obtaining a contract shall:

- (i) Disclose all costs, fees, compensation, reimbursements, and other remunerations paid or to be paid to the lobbyist related to the contract,
- (ii) Not bill or otherwise cause the State of Illinois to pay for any of the lobbyist's costs, fees, compensation, reimbursements, or other remuneration, and
- (iii) Sign a verification certifying that none of the lobbyist's costs, fees, compensation, reimbursements, or other remuneration were billed to the State.

This information, along with all supporting documents, shall be filed with the agency awarding the contract and with the Secretary of State. The chief procurement officer shall post this information, together with the contract award notice, in the online Procurement Bulletin.

Pursuant to Subsection (c) of this Section, no person or entity shall retain a person or entity to attempt to influence the outcome of a procurement decision made under the Procurement Code for compensation contingent in whole or in part upon the decision or procurement. Any person who violates this subsection is guilty of a business offense and shall be fined not more than \$10,000.

Bidder acknowledges that it is required to disclose the hiring of any person required to register pursuant to the Illinois Lobbyist Registration Act (25 ILCS 170) in connection with this contract.

Bidder has not hired any person required to register pursuant to the Illinois Lobbyist Registration Act in connection with this contract.

Or

Bidder has hired the following persons required to register pursuant to the Illinois Lobbyist Registration Act in connection with the contract:

Name and address of person: _____
All costs, fees, compensation, reimbursements and other remuneration paid to said person: _____

RETURN WITH BID

IV. DISCLOSURES

- A. The disclosures hereinafter made by the bidder are each a material representation of fact upon which reliance is placed should the Department enter into the contract with the bidder. The bidder further certifies that the Department has received the disclosure forms for each bid.

The chief procurement officer may void the bid, contract, or subcontract, respectively, if it is later determined that the bidder or subcontractor rendered a false or erroneous disclosure. A contractor or subcontractor may be suspended or debarred for violations of the Procurement Code. Furthermore, the chief procurement officer may void the contract and the surety providing the performance bond shall be responsible for completion of the contract.

B. Financial Interests and Conflicts of Interest

1. Section 50-35 of the Illinois Procurement Code provides that all bids of more than \$25,000 shall be accompanied by disclosure of the financial interests of the bidder. This disclosed information for the successful bidder, will be maintained as public information subject to release by request pursuant to the Freedom of Information Act, filed with the Procurement Policy Board, and shall be incorporated as a material term of the contract. Furthermore, pursuant to Section 5-5, the Procurement Policy Board may review a proposal, bid, or contract and issue a recommendation to void a contract or reject a proposal or bid based on any violation of the Procurement Code or the existence of a conflict of interest as provided in subsections (b) and (d) of Section 50-35.

The financial interests to be disclosed shall include ownership or distributive income share that is in excess of 5%, or an amount greater than 60% of the annual salary of the Governor, of the bidding entity or its parent entity, whichever is less, unless the contractor or bidder is a publicly traded entity subject to Federal 10K reporting, in which case it may submit its 10K disclosure in place of the prescribed disclosure. If a bidder is a privately held entity that is exempt from Federal 10K reporting, but has more than 200 shareholders, it may submit the information that Federal 10K companies are required to report, and list the names of any person or entity holding any ownership share that is in excess of 5%. The disclosure shall include the names, addresses, and dollar or proportionate share of ownership of each person making the disclosure, their instrument of ownership or beneficial relationship, and notice of any potential conflict of interest resulting from the current ownership or beneficial interest of each person making the disclosure having any of the relationships identified in Section 50-35 and on the disclosure form.

The current annual salary of the Governor is \$177,412.00

In addition, all disclosures shall indicate any other current or pending contracts, proposals, leases, or other ongoing procurement relationships the bidding entity has with any other unit of state government and shall clearly identify the unit and the contract, proposal, lease, or other relationship.

2. Disclosure Forms. Disclosure Form A is attached for use concerning the individuals meeting the above ownership or distributive share requirements. Subject individuals should be covered each by one form. In addition, a second form (Disclosure Form B) provides for the disclosure of current or pending procurement relationships with other (non-IDOT) state agencies. **The forms must be included with each bid.**

C. Disclosure Form Instructions

Form A Instructions for Financial Information & Potential Conflicts of Interest

If the bidder is a publicly traded entity subject to Federal 10K reporting, the 10K Report may be submitted to meet the requirements of Form A. If a bidder is a privately held entity that is exempt from Federal 10K reporting, but has more than 200 shareholders, it may submit the information that Federal 10K companies are required to report, and list the names of any person or entity holding any ownership share that is in excess of 5%. If a bidder is not subject to Federal 10K reporting, the bidder must determine if any individuals are required by law to complete a financial disclosure form. To do this, the bidder should answer each of the following questions. A "YES" answer indicates Form A must be completed. If the answer to each of the following questions is "NO", then the **NOT APPLICABLE STATEMENT** on Form A must be signed and dated by a person that is authorized to execute contracts for the bidding company. Note: These questions are for assistance only and are not required to be completed.

1. Does anyone in your organization have a direct or beneficial ownership share of greater than 5% of the bidding entity or parent entity? YES ___ NO ___
2. Does anyone in your organization have a direct or beneficial ownership share of less than 5%, but which has a value greater than 60% of the annual salary of the Governor? YES ___ NO ___
3. Does anyone in your organization receive more than 60% of the annual salary of the Governor of the bidding entity's or parent entity's distributive income? YES ___ NO ___

(Note: Distributive income is, for these purposes, any type of distribution of profits. An annual salary is not distributive income.)

4. Does anyone in your organization receive greater than 5% of the bidding entity's or parent entity's total distributive income, but which is less than 60% of the annual salary of the Governor? YES ___ NO ___

(Note: Only one set of forms needs to be completed per person per bid even if a specific individual would require a yes answer to more than one question.)

A "YES" answer to any of these questions requires the completion of Form A. The bidder must determine each individual in the bidding entity or the bidding entity's parent company that would cause the questions to be answered "Yes". Each form must be signed and dated by a person that is authorized to execute contracts for your organization. **Photocopied or stamped signatures are not acceptable.** The person signing can be, but does not have to be, the person for which the form is being completed. The bidder is responsible for the accuracy of any information provided.

If the answer to each of the above questions is "NO", then the NOT APPLICABLE STATEMENT of Form A must be signed and dated by a person that is authorized to execute contracts for your company.

RETURN WITH BID

Form B: Instructions for Identifying Other Contracts & Procurement Related Information

Disclosure Form B must be completed for each bid submitted by the bidding entity. *Note: Checking the NOT APPLICABLE STATEMENT on Form A does not allow the bidder to ignore Form B. Form B must be completed, checked, and dated or the bidder may be considered nonresponsive and the bid will not be accepted.*

The Bidder shall identify, by checking Yes or No on Form B, whether it has any pending contracts (including leases), bids, proposals, or other ongoing procurement relationship with any other (non-IDOT) State of Illinois agency. If "No" is checked, the bidder only needs to complete the check box on the bottom of Form B. If "Yes" is checked, the bidder must do one of the following:

Option I: If the bidder did not submit an Affidavit of Availability to obtain authorization to bid, the bidder must list all non-IDOT State of Illinois agency pending contracts, leases, bids, proposals, and other ongoing procurement relationships. These items may be listed on Form B or on an attached sheet(s). Do not include IDOT contracts. Contracts with cities, counties, villages, etc. are not considered State of Illinois agency contracts and are not to be included. Contracts with other State of Illinois agencies such as the Department of Natural Resources or the Capital Development Board must be included. Bidders who submit Affidavits of Availability are suggested to use Option II.

Option II: If the bidder is required and has submitted an Affidavit of Availability in order to obtain authorization to bid, the bidder may write or type "See Affidavit of Availability" which indicates that the Affidavit of Availability is incorporated by reference and includes all non-IDOT State of Illinois agency pending contracts, leases, bids, proposals, and other ongoing procurement relationships. For any contracts that are not covered by the Affidavit of Availability, the bidder must identify them on Form B or on an attached sheet(s). These might be such things as leases.

**ILLINOIS DEPARTMENT
OF TRANSPORTATION**

**Form A
Financial Information &
Potential Conflicts of Interest
Disclosure**

Contractor Name		
Legal Address		
City, State, Zip		
Telephone Number	Email Address	Fax Number (if available)

Disclosure of the information contained in this Form is required by the Section 50-35 of the Illinois Procurement Code (30 ILCS 500). Vendors desiring to enter into a contract with the State of Illinois must disclose the financial information and potential conflict of interest information as specified in this Disclosure Form. This information shall become part of the publicly available contract file. This Form A must be completed for bids in excess of \$25,000, and for all open-ended contracts. **A publicly traded company may submit a 10K disclosure (or equivalent if applicable) in satisfaction of the requirements set forth in Form A. See Disclosure Form Instructions.**

The current annual salary of the Governor is \$177,412.00.

DISCLOSURE OF FINANCIAL INFORMATION

1. Disclosure of Financial Information. The individual named below has an interest in the BIDDER (or its parent) in terms of ownership or distributive income share in excess of 5%, or an interest which has a value of more than 60% of the annual salary of the Governor. **(Make copies of this form as necessary and attach a separate Disclosure Form A for each individual meeting these requirements)**

FOR INDIVIDUAL (type or print information)	
NAME:	_____
ADDRESS	_____
Type of ownership/distributable income share:	
stock _____ sole proprietorship _____ Partnership _____ other: (explain on separate sheet):	
% or \$ value of ownership/distributable income share:	_____

2. Disclosure of Potential Conflicts of Interest. Check "Yes" or "No" to indicate which, if any, of the following potential conflict of interest relationships apply. If the answer to any question is "Yes", please attach additional pages and describe.

(a) State employment, currently or in the previous 3 years, including contractual employment of services. Yes ___ No ___

If your answer is yes, please answer each of the following questions.

1. Are you currently an officer or employee of either the Capitol Development Board or the Illinois State Toll Highway Authority? Yes ___ No ___

2. Are you currently appointed to or employed by any agency of the State of Illinois? If you are currently appointed to or employed by any agency of the State of Illinois, and your annual salary exceeds 60% of the annual salary of the Governor, provide the name the State agency for which you are employed and your annual salary. _____

RETURN WITH BID

3. If you are currently appointed to or employed by any agency of the State of Illinois, and your annual salary exceeds 60% of the annual salary of the Governor, are you entitled to receive (i) more than 7 1/2% of the total distributable income of your firm, partnership, association or corporation, or (ii) an amount in excess of 100% of the annual salary of the Governor?
Yes ___ No ___
4. If you are currently appointed to or employed by any agency of the State of Illinois, and your annual salary exceeds 60% of the annual salary of the Governor, are you and your spouse or minor children entitled to receive (i) more than 15 % in the aggregate of the total distributable income of your firm, partnership, association or corporation, or (ii) an amount in excess of two times the salary of the Governor?
Yes ___ No ___

(b) State employment of spouse, father, mother, son, or daughter, including contractual employment services in the previous 2 years.

Yes ___ No ___

If your answer is yes, please answer each of the following questions.

1. Is your spouse or any minor children currently an officer or employee of the Capitol Development Board or the Illinois State Toll Highway Authority?
Yes ___ No ___
2. Is your spouse or any minor children currently appointed to or employed by any agency of the State of Illinois? If your spouse or minor children is/are currently appointed to or employed by any agency of the State of Illinois, and his/her annual salary exceeds 60% of the annual salary of the Governor, provide the name of your spouse and/or minor children, the name of the State agency for which he/she is employed and his/her annual salary. _____

3. If your spouse or any minor children is/are currently appointed to or employed by any agency of the State of Illinois, and his/her annual salary exceeds 60% of the annual salary of the Governor, are you entitled to receive (i) more than 7 1/2% of the total distributable income of your firm, partnership, association or corporation, or (ii) an amount in excess of 100% of the annual salary of the Governor?
Yes ___ No ___
4. If your spouse or any minor children are currently appointed to or employed by any agency of the State of Illinois, and his/her annual salary exceeds 60% of the annual salary of the Governor, are you and your spouse or minor children entitled to receive (i) more than 15 % in the aggregate of the total distributable income of your firm, partnership, association or corporation, or (ii) an amount in excess of 2 times the salary of the Governor?
Yes ___ No ___

(c) Elective status; the holding of elective office of the State of Illinois, the government of the United States, any unit of local government authorized by the Constitution of the State of Illinois or the statutes of the State of Illinois currently or in the previous 3 years.
Yes ___ No ___

(d) Relationship to anyone holding elective office currently or in the previous 2 years; spouse, father, mother, son, or daughter.
Yes ___ No ___

(e) Appointive office; the holding of any appointive government office of the State of Illinois, the United States of America, or any unit of local government authorized by the Constitution of the State of Illinois or the statutes of the State of Illinois, which office entitles the holder to compensation in excess of the expenses incurred in the discharge of that office currently or in the previous 3 years.
Yes ___ No ___

(f) Relationship to anyone holding appointive office currently or in the previous 2 years; spouse, father, mother, son, or daughter.
Yes ___ No ___

(g) Employment, currently or in the previous 3 years, as or by any registered lobbyist of the State government.
Yes ___ No ___

RETURN WITH BID/OFFER

(h) Relationship to anyone who is or was a registered lobbyist in the previous 2 years; spouse, father, mother, son, or daughter. Yes ___ No ___

(i) Compensated employment, currently or in the previous 3 years, by any registered election or reelection committee registered with the Secretary of State or any county clerk of the State of Illinois, or any political action committee registered with either the Secretary of State or the Federal Board of Elections. Yes ___ No ___

(j) Relationship to anyone; spouse, father, mother, son, or daughter; who was a compensated employee in the last 2 years by any registered election or re-election committee registered with the Secretary of State or any county clerk of the State of Illinois, or any political action committee registered with either the Secretary of State or the Federal Board of Elections. Yes ___ No ___

2. Communication Disclosure.

Disclose the name and address of each lobbyist and other agent of the bidder or offeror who is not identified in Section 2 of this form, who is has communicated, is communicating, or may communicate with any State officer or employee concerning the bid or offer. This disclosure is a continuing obligation and must be promptly supplemented for accuracy throughout the process and throughout the term of the contract. If no person is identified, enter "None" on the line below:

Name and address of person(s): _____

RETURN WITH BID

4. Debarment Disclosure. For each of the persons identified under Sections 2 and 3 of this form, disclose whether any of the following has occurred within the previous 10 years: debarment from contracting with any governmental entity; professional licensure discipline; bankruptcies; adverse civil judgments and administrative findings; and criminal felony convictions. This disclosure is a continuing obligation and must be promptly supplemented for accuracy throughout the procurement process and term of the contract. If no person is identified, enter "None" on the line below:

Name of person(s): _____

Nature of disclosure: _____

APPLICABLE STATEMENT

This Disclosure Form A is submitted on behalf of the INDIVIDUAL named on previous page. Under penalty of perjury, I certify the contents of this disclosure to be true and accurate to the best of my knowledge.

Completed by: _____ Date _____
Signature of Individual or Authorized Representative

NOT APPLICABLE STATEMENT

Under penalty of perjury, I have determined that no individuals associated with this organization meet the criteria that would require the completion of this Form A.

This Disclosure Form A is submitted on behalf of the CONTRACTOR listed on the previous page.

_____ Date _____
Signature of Authorized Representative

The bidder has a continuing obligation to supplement these disclosures under Sec. 50-35 of the Procurement Code.

RETURN WITH BID

ILLINOIS DEPARTMENT
OF TRANSPORTATION

Form B
Other Contracts &
Procurement Related Information
Disclosure

Contractor Name		
Legal Address		
City, State, Zip		
Telephone Number	Email Address	Fax Number (if available)

Disclosure of the information contained in this Form is required by the Section 50-35 of the Illinois Procurement Act (30 ILCS 500). This information shall become part of the publicly available contract file. This Form B must be completed for bids in excess of \$25,000, and for all open-ended contracts.

DISCLOSURE OF OTHER CONTRACTS AND PROCUREMENT RELATED INFORMATION

1. Identifying Other Contracts & Procurement Related Information. The BIDDER shall identify whether it has any pending contracts (including leases), bids, proposals, or other ongoing procurement relationship with any other State of Illinois agency: Yes ___ No ___

If "No" is checked, the bidder only needs to complete the signature box on the bottom of this page.

2. If "Yes" is checked. Identify each such relationship by showing State of Illinois agency name and other descriptive information such as bid or project number (attach additional pages as necessary). SEE DISCLOSURE FORM INSTRUCTIONS:

THE FOLLOWING STATEMENT MUST BE CHECKED

<input type="checkbox"/>	_____	_____
	Signature of Authorized Representative	Date

RETURN WITH BID

SPECIAL NOTICE TO CONTRACTORS

The following requirements of the Illinois Department of Human Rights' Rules and Regulations are applicable to bidders on all construction contracts advertised by the Illinois Department of Transportation:

CONSTRUCTION EMPLOYEE UTILIZATION PROJECTION

- (a) All bidders on construction contracts shall complete and submit, along with and as part of their bids, a Bidder's Employee Utilization Form (Form BC-1256) setting forth a projection and breakdown of the total workforce intended to be hired and/or allocated to such contract work by the bidder including a projection of minority and female employee utilization in all job classifications on the contract project.
- (b) The Department of Transportation shall review the Employee Utilization Form, and workforce projections contained therein, of the contract awardee to determine if such projections reflect an underutilization of minority persons and/or women in any job classification in accordance with the Equal Employment Opportunity Clause and Section 7.2 of the Illinois Department of Human Rights' Rules and Regulations for Public Contracts adopted as amended on September 17, 1980. If it is determined that the contract awardee's projections reflect an underutilization of minority persons and/or women in any job classification, it shall be advised in writing of the manner in which it is underutilizing and such awardee shall be considered to be in breach of the contract unless, prior to commencement of work on the contract project, it submits revised satisfactory projections or an acceptable written affirmative action plan to correct such underutilization including a specific timetable geared to the completion stages of the contract.
- (c) The Department of Transportation shall provide to the Department of Human Rights a copy of the contract awardee's Employee Utilization Form, a copy of any required written affirmative action plan, and any written correspondence related thereto. The Department of Human Rights may review and revise any action taken by the Department of Transportation with respect to these requirements.

RETURN WITH BID

**Contract No. 64H30
Various Counties
Section D2 GREENLIGHT 2012-2
Various Routes
District 2 Construction Funds**

PART II. WORKFORCE PROJECTION - continued

- B. Included in "Total Employees" under Table A is the total number of **new hires** that would be employed in the event the undersigned bidder is awarded this contract.

The undersigned bidder projects that: (number) _____ new hires would be recruited from the area in which the contract project is located; and/or (number) _____ new hires would be recruited from the area in which the bidder's principal office or base of operation is located.

- C. Included in "Total Employees" under Table A is a projection of numbers of persons to be employed directly by the undersigned bidder as well as a projection of numbers of persons to be employed by subcontractors.

The undersigned bidder estimates that (number) _____ persons will be directly employed by the prime contractor and that (number) _____ persons will be employed by subcontractors.

PART III. AFFIRMATIVE ACTION PLAN

- A. The undersigned bidder understands and agrees that in the event the foregoing minority and female employee utilization projection included under **PART II** is determined to be an underutilization of minority persons or women in any job category, and in the event that the undersigned bidder is awarded this contract, he/she will, prior to commencement of work, develop and submit a written Affirmative Action Plan including a specific timetable (geared to the completion stages of the contract) whereby deficiencies in minority and/or female employee utilization are corrected. Such Affirmative Action Plan will be subject to approval by the contracting agency and the **Department of Human Rights**.
- B. The undersigned bidder understands and agrees that the minority and female employee utilization projection submitted herein, and the goals and timetable included under an Affirmative Action Plan if required, are deemed to be part of the contract specifications.

Company _____ Telephone Number _____

Address _____

NOTICE REGARDING SIGNATURE

The Bidder's signature on the Proposal Signature Sheet will constitute the signing of this form. The following signature block needs to be completed if revisions are required.

Signature: _____ Title: _____ Date: _____

- Instructions: All tables must include subcontractor personnel in addition to prime contractor personnel.
- Table A - Include both the number of employees that would be hired to perform the contract work and the total number currently employed (Table B) that will be allocated to contract work, and include all apprentices and on-the-job trainees. The "Total Employees" column should include all employees including all minorities, apprentices and on-the-job trainees to be employed on the contract work.
- Table B - Include all employees currently employed that will be allocated to the contract work including any apprentices and on-the-job trainees currently employed.
- Table C - Indicate the racial breakdown of the total apprentices and on-the-job trainees shown in Table A.

RETURN WITH BID
Contract No. 64H30
Various Counties
Section D2 GREENLIGHT 2012-2
Various Routes
District 2 Construction Funds

PROPOSAL SIGNATURE SHEET

The undersigned bidder hereby makes and submits this bid on the subject Proposal, thereby assuring the Department that all requirements of the Invitation for Bids and rules of the Department have been met, that there is no misunderstanding of the requirements of paragraph 3 of this Proposal, and that the contract will be executed in accordance with the rules of the Department if an award is made on this bid.

(IF AN INDIVIDUAL)

Firm Name _____

Signature of Owner _____

Business Address _____

(IF A CO-PARTNERSHIP)

Firm Name _____

By _____

Business Address _____

Name and Address of All Members of the Firm:

(IF A CORPORATION)

Corporate Name _____

By _____

Signature of Authorized Representative

Typed or printed name and title of Authorized Representative

Attest _____

Signature

(IF A JOINT VENTURE, USE THIS SECTION FOR THE MANAGING PARTY AND THE SECOND PARTY SHOULD SIGN BELOW)

Business Address _____

(IF A JOINT VENTURE)

Corporate Name _____

By _____

Signature of Authorized Representative

Typed or printed name and title of Authorized Representative

Attest _____

Signature

Business Address _____

If more than two parties are in the joint venture, please attach an additional signature sheet.



Return with Bid

Division of Highways
Proposal Bid Bond
(Effective November 1, 1992)

Item No.
Letting Date

KNOW ALL MEN BY THESE PRESENTS, That We

as PRINCIPAL, and

as SURETY, are held jointly, severally and firmly bound unto the STATE OF ILLINOIS in the penal sum of 5 percent of the total bid price, or for the amount specified in the bid proposal under "Proposal Guaranty" in effect on the date of the Invitation for Bids, whichever is the lesser sum, well and truly to be paid unto said STATE OF ILLINOIS, for the payment of which we bind ourselves, our heirs, executors, administrators, successors and assigns.

THE CONDITION OF THE FOREGOING OBLIGATION IS SUCH, that whereas, the PRINCIPAL has submitted a bid proposal to the STATE OF ILLINOIS, acting through the Department of Transportation, for the improvement designated by the Transportation Bulletin Item Number and Letting Date indicated above.

NOW, THEREFORE, if the Department shall accept the bid proposal of the PRINCIPAL; and if the PRINCIPAL shall, within the time and as specified in the bidding and contract documents, submit a DBE Utilization Plan that is accepted and approved by the Department; and if, after award by the Department, the PRINCIPAL shall enter into a contract in accordance with the terms of the bidding and contract documents including evidence of the required insurance coverages and providing such bond as specified with good and sufficient surety for the faithful performance of such contract and for the prompt payment of labor and material furnished in the prosecution thereof; or if, in the event of the failure of the PRINCIPAL to make the required DBE submission or to enter into such contract and to give the specified bond, the PRINCIPAL pays to the Department the difference not to exceed the penalty hereof between the amount specified in the bid proposal and such larger amount for which the Department may contract with another party to perform the work covered by said bid proposal, then this obligation shall be null and void, otherwise, it shall remain in full force and effect.

IN THE EVENT the Department determines the PRINCIPAL has failed to comply with any requirement as set forth in the preceding paragraph, then Surety shall pay the penal sum to the Department within fifteen (15) days of written demand therefor. If Surety does not make full payment within such period of time, the Department may bring an action to collect the amount owed. Surety is liable to the Department for all its expenses, including attorney's fees, incurred in any litigation in which it prevails either in whole or in part.

In TESTIMONY WHEREOF, the said PRINCIPAL and the said SURETY have caused this instrument to be signed by their respective officers this day of A.D.,

PRINCIPAL SURETY
(Company Name) (Company Name)
By (Signature & Title) By: (Signature of Attorney-in-Fact)

Notary Certification for Principal and Surety

STATE OF ILLINOIS,
County of
I, , a Notary Public in and for said County, do hereby certify that
and
(Insert names of individuals signing on behalf of PRINCIPAL & SURETY)

who are each personally known to me to be the same persons whose names are subscribed to the foregoing instrument on behalf of PRINCIPAL and SURETY, appeared before me this day in person and acknowledged respectively, that they signed and delivered said instrument as their free and voluntary act for the uses and purposes therein set forth.

Given under my hand and notarial seal this day of A.D.
My commission expires
Notary Public

In lieu of completing the above section of the Proposal Bid Form, the Principal may file an Electronic Bid Bond. By signing the proposal and marking the check box next to the Signature and Title line below, the Principal is ensuring the identified electronic bid bond has been executed and the Principal and Surety are firmly bound unto the State of Illinois under the conditions of the bid bond as shown above.

Electronic Bid Bond ID# Company / Bidder Name Signature and Title



(1) Policy

It is public policy that disadvantageded businesses as defined in 49 CFR Part 26 and the Special Provision shall have the maximum opportunity to participate in the performance of contracts financed in whole or in part with Federal or State funds. Consequently the requirements of 49 CFR Part 26 apply to this contract.

(2) Obligation

The contractor agrees to ensure that disadvantageded businesses as defined in 49 CFR Part 26 and the Special Provision have the maximum opportunity to participate in the performance of contracts or subcontracts financed in whole or in part with Federal or State funds. The contractor shall take all necessary and reasonable steps in accordance with 49 CFR Part 26 and the Special Provision to ensure that said businesses have the maximum opportunity to compete for and perform under this contract. The contractor shall not discriminate on the basis of race, color, national origin or sex in the award and performance of contracts.

(3) Project and Bid Identification

Complete the following information concerning the project and bid:

Route _____
Section _____
Project _____
County _____
Letting Date _____
Contract No. _____
Letting Item No. _____

Total Bid _____
Contract DBE Goal _____ (Percent) _____ (Dollar Amount)

(4) Assurance

I, acting in my capacity as an officer of the undersigned bidder (or bidders if a joint venture), hereby assure the Department that on this project my company : (check one)

[] Meets or exceeds contract award goals and has provided documented participation as follows:
Disadvantaged Business Participation _____ percent

Attached are the signed participation statements, forms SBE 2025, required by the Special Provision evidencing availability and use of each business participating in this plan and assuring that each business will perform a commercially useful function in the work of the contract.

[] Failed to meet contract award goals and has included good faith effort documentation to meet the goals and that my company has provided participation as follows:

Disadvantaged Business Participation _____ percent

The contract goals should be accordingly modified or waived. Attached is all information required by the Special Provision in support of this request including good faith effort. Also attached are the signed participation statements, forms SBE 2025, required by the Special Provision evidencing availability and use of each business participating in this plan and assuring that each business will perform a commercially useful function in the work of the contract.

Company _____
By _____
Title _____
Date _____

The "as read" Low Bidder is required to comply with the Special Provision.
Submit only one utilization plan for each project. The utilization plan shall be submitted in accordance with the special provision.
Bureau of Small Business Enterprises
2300 South Dirksen Parkway
Springfield, Illinois 62764
Local Let Projects
Submit forms to the
Local Agency

The Department of Transportation is requesting disclosure of information that is necessary to accomplish the purpose as outlined under State and Federal law. Disclosure of this information is REQUIRED. Failure to provide any information will result in the contract not being awarded. This form has been approved by the State Forms Manager Center.



Illinois Department of Transportation

DBE Participation Statement

Subcontractor Registration _____

Letting _____

Participation Statement

Item No. _____

(1) Instructions

Contract _____

This form must be completed for each disadvantaged business participating in the Utilization Plan. This form shall be submitted in accordance with the special provision and will be attached to the Utilization Plan form. If additional space is needed complete an additional form for the firm.

(2) Work

Pay Item No.	Description	Quantity	Unit Price	Total
Total				

(3) Partial Payment Items

For any of the above items which are partial pay items, specifically describe the work and subcontract dollar amount:

(4) Commitment

The undersigned certify that the information included herein is true and correct, and that the DBE firm listed below has agreed to perform a commercially useful function in the work of the contract item(s) listed above and to execute a contract with the prime contractor. The undersigned further understand that no changes to this statement may be made without prior approval from the Department's Bureau of Small Business Enterprises and that complete and accurate information regarding actual work performed on this project and the payment therefore must be provided to the Department.

Signature for Prime Contractor

Signature for DBE Firm

Title _____

Title _____

Date _____

Date _____

Contact _____

Contact _____

Phone _____

Phone _____

Firm Name _____

Firm Name _____

Address _____

Address _____

City/State/Zip _____

City/State/Zip _____

E _____

WC _____

The Department of Transportation is requesting disclosure of information that is necessary to accomplish the statutory purpose as outlined under the state and federal law. Disclosure of this information is **REQUIRED**. Failure to provide any information will result in the contract not being awarded. This form has been approved by the State Forms Management Center.

PROPOSAL ENVELOPE



PROPOSALS

for construction work advertised for bids by the
Illinois Department of Transportation

Item No.	Item No.	Item No.

Submitted By:

Name:
Address:
Phone No.

Bidders should use an IDOT proposal envelope or affix this form to the front of a 10" x 13" envelope for the submittal of bids. If proposals are mailed, they should be enclosed in a second or outer envelope addressed to:

Engineer of Design and Environment - Room 326
Illinois Department of Transportation
2300 South Dirksen Parkway
Springfield, Illinois 62764

NOTICE

Individual bids, including Bid Bond and/or supplemental information if required, should be securely stapled.

CONTRACTOR OFFICE COPY OF CONTRACT SPECIFICATIONS

NOTICE

None of the following material needs to be returned with the bid package unless the special provisions require documentation and/or other information to be submitted.

Contract No. 64H30
Various Counties
Section D2 GREENLIGHT 2012-2
Various Routes
District 2 Construction Funds



Illinois Department of Transportation

SUBCONTRACTOR DOCUMENTATION

Public Acts 96-0795 and 96-0920, enacted substantial changes to the provisions of the Illinois Procurement Code (30 ILCS 500). Among the changes are provisions affecting subcontractors. The Contractor awarded this contract will be required as a material condition of the contract to implement and enforce the contract requirements applicable to subcontractors approved in accordance with article 108.01 of the Standard Specifications for Road and Bridge Construction.

If the Contractor seeks approval of subcontractors to perform a portion of the work, and approval is granted by the Department, the Contractor shall provide a copy of the subcontract to the Chief Procurement Officer within 20 calendar days after execution of the subcontract.

The subcontract shall contain the certifications required to be made by subcontractors pursuant to Article 50 of the Illinois Procurement Code. This Notice to Bidders includes a document incorporating all required subcontractor certifications and disclosures for use by the Contractor in compliance with this mandate. The document is entitled State Required Ethical Standards Governing Subcontractors.

RETURN WITH SUBCONTRACT

STATE ETHICAL STANDARDS GOVERNING SUBCONTRACTORS

Article 50 of the Illinois Procurement Code establishes the duty of all State chief procurement officers, State purchasing officers, and their designees to maximize the value of the expenditure of public moneys in procuring goods, services, and contracts for the State of Illinois and to act in a manner that maintains the integrity and public trust of State government. In discharging this duty, they are charged by law to use all available information, reasonable efforts, and reasonable actions to protect, safeguard, and maintain the procurement process of the State of Illinois.

The certifications hereinafter made by the subcontractor are each a material representation of fact upon which reliance is placed should the Department approve the subcontractor. The chief procurement officer may terminate or void the subcontract approval if it is later determined that the bidder or subcontractor rendered a false or erroneous certification.

Section 50-2 of the Illinois Procurement Code provides that every person that has entered into a multi-year contract and every subcontractor with a multi-year subcontract shall certify, by July 1 of each fiscal year covered by the contract after the initial fiscal year, to the responsible chief procurement officer whether it continues to satisfy the requirements of Article 50 pertaining to the eligibility for a contract award. If a contractor or subcontractor is not able to truthfully certify that it continues to meet all requirements, it shall provide with its certification a detailed explanation of the circumstances leading to the change in certification status. A contractor or subcontractor that makes a false statement material to any given certification required under Article 50 is, in addition to any other penalties or consequences prescribed by law, subject to liability under the Whistleblower Reward and Protection Act for submission of a false claim.

A. Bribery

1. The Illinois Procurement Code provides:

Section 50-5. Bribery.

(a) Prohibition. No person or business shall be awarded a contract or subcontract under this Code who:

(1) has been convicted under the laws of Illinois or any other state of bribery or attempting to bribe an officer or employee of the State of Illinois or any other state in that officer's or employee's official capacity; or

(2) has made an admission of guilt of that conduct that is a matter of record but has not been prosecuted for that conduct.

(b) Businesses. No business shall be barred from contracting with any unit of State or local government, or subcontracting under such a contract, as a result of a conviction under this Section of any employee or agent of the business if the employee or agent is no longer employed by the business and:

(1) the business has been finally adjudicated not guilty; or

(2) the business demonstrates to the governmental entity with which it seeks to contract, or which is signatory to the contract to which the subcontract relates, and that entity finds that the commission of the offense was not authorized, requested, commanded, or performed by a director, officer, or high managerial agent on behalf of the business as provided in paragraph (2) of subsection (a) of Section 5-4 of the Criminal Code of 1961.

(c) Conduct on behalf of business. For purposes of this Section, when an official, agent, or employee of a business committed the bribery or attempted bribery on behalf of the business and in accordance with the direction or authorization of a responsible official of the business, the business shall be chargeable with the conduct.

(d) Certification. Every bid submitted to and contract executed by the State, and every subcontract subject to Section 20-120 of the Procurement Code shall contain a certification by the contractor or the subcontractor, respectively, that the contractor or subcontractor is not barred from being awarded a contract or subcontract under this Section and acknowledges that the chief procurement officer may declare the related contract void if any certifications required by this Section are false. A contractor who makes a false statement, material to the certification, commits a Class 3 felony.

2. The contractor or subcontractor certifies that it is not barred from being awarded a contract under Section 50.5.

B. Felons

1. The Illinois Procurement Code provides:

Section 50-10. Felons. Unless otherwise provided, no person or business convicted of a felony shall do business with the State of Illinois or any State agency, or enter into a subcontract, from the date of conviction until 5 years after the date of completion of the sentence for that felony, unless no person held responsible by a prosecutorial office for the facts upon which the conviction was based continues to have any involvement with the business.

2. Certification. Every bid submitted to and contract executed by the State and every subcontract subject to Section 20-120 of the Procurement Code shall contain a certification by the bidder or contractor or subcontractor, respectively, that the bidder, contractor, or subcontractor is not barred from being awarded a contract or subcontract under this Section and acknowledges that the chief procurement officer may declare the related contract void if any of the certifications required by this Section are false.

RETURN WITH SUBCONTRACT

C. Debt Delinquency

1. The Illinois Procurement Code provides:

Section 50-11 and 50-12. Debt Delinquency.

The contractor or bidder or subcontractor, respectively, certifies that it, or any affiliate, is not barred from being awarded a contract or subcontract under the Procurement Code. Section 50-11 prohibits a person from entering into a contract with a State agency, or entering into a subcontract, if it knows or should know that it, or any affiliate, is delinquent in the payment of any debt to the State as defined by the Debt Collection Board. Section 50-12 prohibits a person from entering into a contract with a State agency, or entering into a subcontract, if it, or any affiliate, has failed to collect and remit Illinois Use Tax on all sales of tangible personal property into the State of Illinois in accordance with the provisions of the Illinois Use Tax Act. The bidder or contractor or subcontractor, respectively, further acknowledges that the chief procurement officer may declare the related contract void if this certification is false or if the bidder, contractor, or subcontractor, or any affiliate, is determined to be delinquent in the payment of any debt to the State during the term of the contract.

D. Prohibited Bidders, Contractors and Subcontractors

1. The Illinois Procurement Code provides:

Section 50-10.5 and 50-60(c). Prohibited bidders, contractors and subcontractors.

The bidder or contractor or subcontractor, respectively, certifies in accordance with 30 ILCS 500/50-10.5 that no officer, director, partner or other managerial agent of the contracting business has been convicted of a felony under the Sarbanes-Oxley Act of 2002 or a Class 3 or Class 2 felony under the Illinois Securities Law of 1953 or if in violation of Subsection (c) for a period of five years from the date of conviction.. Every bid submitted to and contract executed by the State and every subcontract subject to Section 20-120 of the Procurement Code shall contain a certification by the bidder, contractor, or subcontractor, respectively, that the bidder, contractor, or subcontractor is not barred from being awarded a contract or subcontract under this Section and acknowledges that the chief procurement officer shall declare the related contract void if any of the certifications completed pursuant to this Section are false.

E. Section 42 of the Environmental Protection Act

The bidder or contractor or subcontractor, respectively, certifies in accordance with 30 ILCS 500/50-12 that the bidder, contractor, or subcontractor, is not barred from being awarded a contract or entering into a subcontract under this Section which prohibits the bidding on or entering into contracts with the State of Illinois or a State agency, or entering into any subcontract, that is subject to the Procurement Code by a person or business found by a court or the Pollution Control Board to have committed a willful or knowing violation of Section 42 of the Environmental Protection Act for a period of five years from the date of the order. The bidder or contractor or subcontractor, respectively, acknowledges that the chief procurement officer may declare the contract void if this certification is false.

The undersigned, on behalf of the subcontracting company, has read and understands the above certifications and makes the certifications as required by law.

_____ Name of Subcontracting Company		
_____ Authorized Officer	_____ Date	

RETURN WITH SUBCONTRACT
SUBCONTRACTOR DISCLOSURES

I. DISCLOSURES

- A. The disclosures hereinafter made by the subcontractor are each a material representation of fact upon which reliance is placed. The subcontractor further certifies that the Department has received the disclosure forms for each subcontract.

The chief procurement officer may void the bid, contract, or subcontract, respectively, if it is later determined that the bidder or subcontractor rendered a false or erroneous disclosure. A contractor or subcontractor may be suspended or debarred for violations of the Procurement Code. Furthermore, the chief procurement officer may void the contract or subcontract.

B. Financial Interests and Conflicts of Interest

1. Section 50-35 of the Illinois Procurement Code provides that all subcontracts with a total value of \$25,000 or more from subcontractors identified in Section 20-120 of the Illinois Procurement Code, shall be accompanied by disclosure of the financial interests of the subcontractor. This disclosed information for the subcontractor, will be maintained as public information subject to release by request pursuant to the Freedom of Information Act, filed with the Procurement Policy Board, and shall be incorporated as a material term of the Prime Contractor's contract. Furthermore, pursuant to this Section, the Procurement Policy Board may recommend to allow or void a contract or subcontract based on a potential conflict of interest.

The financial interests to be disclosed shall include ownership or distributive income share that is in excess of 5%, or an amount greater than 60% of the annual salary of the Governor, of the subcontracting entity or its parent entity, whichever is less, unless the subcontractor is a publicly traded entity subject to Federal 10K reporting, in which case it may submit its 10K disclosure in place of the prescribed disclosure. If a subcontractor is a privately held entity that is exempt from Federal 10K reporting, but has more than 200 shareholders, it may submit the information that Federal 10K companies are required to report, and list the names of any person or entity holding any ownership share that is in excess of 5%. The disclosure shall include the names, addresses, and dollar or proportionate share of ownership of each person making the disclosure, their instrument of ownership or beneficial relationship, and notice of any potential conflict of interest resulting from the current ownership or beneficial interest of each person making the disclosure having any of the relationships identified in Section 50-35 and on the disclosure form.

The current annual salary of the Governor is \$177,412.00.

In addition, all disclosures shall indicate any other current or pending contracts, subcontracts, proposals, leases, or other ongoing procurement relationships the subcontracting entity has with any other unit of state government and shall clearly identify the unit and the contract, subcontract, proposal, lease, or other relationship.

2. Disclosure Forms. Disclosure Form A is attached for use concerning the individuals meeting the above ownership or distributive share requirements. Subject individuals should be covered each by one form. In addition, a second form (Disclosure Form B) provides for the disclosure of current or pending procurement relationships with other (non-IDOT) state agencies.

C. Disclosure Form Instructions

Form A Instructions for Financial Information & Potential Conflicts of Interest

If the subcontractor is a publicly traded entity subject to Federal 10K reporting, the 10K Report may be submitted to meet the requirements of Form A. If a subcontractor is a privately held entity that is exempt from Federal 10K reporting, but has more than 200 shareholders, it may submit the information that Federal 10K companies are required to report, and list the names of any person or entity holding any ownership share that is in excess of 5%. If a subcontractor is not subject to Federal 10K reporting, the subcontractor must determine if any individuals are required by law to complete a financial disclosure form. To do this, the subcontractor should answer each of the following questions. A "YES" answer indicates Form A must be completed. If the answer to each of the following questions is "NO", then the **NOT APPLICABLE STATEMENT** on the second page of Form A must be signed and dated by a person that is authorized to execute contracts for the subcontracting company. Note: These questions are for assistance only and are not required to be completed.

1. Does anyone in your organization have a direct or beneficial ownership share of greater than 5% of the bidding entity or parent entity? YES ___ NO ___
2. Does anyone in your organization have a direct or beneficial ownership share of less than 5%, but which has a value greater than 60% of the annual salary of the Governor? YES ___ NO ___
3. Does anyone in your organization receive more than 60% of the annual salary of the Governor of the subcontracting entity's or parent entity's distributive income? YES ___ NO ___

(Note: Distributive income is, for these purposes, any type of distribution of profits. An annual salary is not distributive income.)

4. Does anyone in your organization receive greater than 5% of the subcontracting entity's or parent entity's total distributive income, but which is less than 60% of the annual salary of the Governor? YES ___ NO ___

(Note: Only one set of forms needs to be completed per person per subcontract even if a specific individual would require a yes answer to more than one question.)

A "YES" answer to any of these questions requires the completion of Form A. The subcontractor must determine each individual in the subcontracting entity or the subcontracting entity's parent company that would cause the questions to be answered "Yes". Each form must be signed and dated by a person that is authorized to execute contracts for your organization. **Photocopied or stamped signatures are not acceptable.** The person signing can be, but does not have to be, the person for which the form is being completed. The subcontractor is responsible for the accuracy of any information provided.

If the answer to each of the above questions is "NO", then the **NOT APPLICABLE STATEMENT** on page 2 of Form A must be signed and dated by a person that is authorized to execute contracts for your company.

RETURN WITH SUBCONTRACT

Form B: Instructions for Identifying Other Contracts & Procurement Related Information

Disclosure Form B must be completed for each subcontract submitted by the subcontracting entity. *Note: Checking the NOT APPLICABLE STATEMENT on Form A does not allow the subcontractor to ignore Form B. Form B must be completed, checked, and dated or the subcontract will not be approved.*

The Subcontractor shall identify, by checking Yes or No on Form B, whether it has any pending contracts, subcontracts, leases, bids, proposals, or other ongoing procurement relationship with any other (non-IDOT) State of Illinois agency. If "No" is checked, the subcontractor only needs to complete the check box on the bottom of Form B. If "Yes" is checked, the subcontractor must list all non-IDOT State of Illinois agency pending contracts, subcontracts, leases, bids, proposals, and other ongoing procurement relationships. These items may be listed on Form B or on an attached sheet(s). Contracts with cities, counties, villages, etc. are not considered State of Illinois agency contracts and are not to be included. Contracts or subcontracts with other State of Illinois agencies such as the Department of Natural Resources or the Capital Development Board must be included.

ILLINOIS DEPARTMENT OF TRANSPORTATION

Form A Subcontractor: Financial Information & Potential Conflicts of Interest Disclosure

Form with fields: Subcontractor Name, Legal Address, City, State, Zip, Telephone Number, Email Address, Fax Number (if available)

Disclosure of the information contained in this Form is required by the Section 50-35 of the Illinois Procurement Code (30 ILCS 500). Subcontractors desiring to enter into a subcontract of a State of Illinois contract must disclose the financial information and potential conflict of interest information as specified in this Disclosure Form. This information shall become part of the publicly available contract file. This Form A must be completed for subcontracts with a total value of \$25,000 or more, from subcontractors identified in Section 20-120 of the Illinois Procurement Code, and for all open-ended contracts. A publicly traded company may submit a 10K disclosure (or equivalent if applicable) in satisfaction of the requirements set forth in Form A. See Disclosure Form Instructions.

The current annual salary of the Governor is \$177,412.00.

DISCLOSURE OF FINANCIAL INFORMATION

1. Disclosure of Financial Information. The individual named below has an interest in the SUBCONTRACTOR (or its parent) in terms of ownership or distributive income share in excess of 5%, or an interest which has a value of more than 60% of the annual salary of the Governor. (Make copies of this form as necessary and attach a separate Disclosure Form A for each individual meeting these requirements)

FOR INDIVIDUAL (type or print information) NAME: ADDRESS Type of ownership/distributable income share: stock sole proprietorship Partnership other: (explain on separate sheet): % or \$ value of ownership/distributable income share:

2. Disclosure of Potential Conflicts of Interest. Check "Yes" or "No" to indicate which, if any, of the following potential conflict of interest relationships apply. If the answer to any question is "Yes", please attach additional pages and describe.

(a) State employment, currently or in the previous 3 years, including contractual employment of services. Yes ___ No ___

If your answer is yes, please answer each of the following questions.

- 1. Are you currently an officer or employee of either the Capitol Development Board or the Illinois State Toll Highway Authority? Yes ___ No ___
2. Are you currently appointed to or employed by any agency of the State of Illinois? If you are currently appointed to or employed by any agency of the State of Illinois, and your annual salary exceeds 60% of the annual salary of the Governor, provide the name the State agency for which you are employed and your annual salary.

RETURN WITH SUBCONTRACT

3. If you are currently appointed to or employed by any agency of the State of Illinois, and your annual salary exceeds 60% of the annual salary of the Governor, are you entitled to receive (i) more than 7 1/2% of the total distributable income of your firm, partnership, association or corporation, or (ii) an amount in excess of 100% of the annual salary of the Governor?
Yes ___ No ___

4. If you are currently appointed to or employed by any agency of the State of Illinois, and your annual salary exceeds 60% of the annual salary of the Governor, are you and your spouse or minor children entitled to receive (i) more than 15 % in the aggregate of the total distributable income of your firm, partnership, association or corporation, or (ii) an amount in excess of two times the salary of the Governor?
Yes ___ No ___

(b) State employment of spouse, father, mother, son, or daughter, including contractual employment services in the previous 2 years.

Yes ___ No ___

If your answer is yes, please answer each of the following questions.

1. Is your spouse or any minor children currently an officer or employee of the Capitol Development Board or the Illinois Toll Highway Authority?
Yes ___ No ___

2. Is your spouse or any minor children currently appointed to or employed by any agency of the State of Illinois? If your spouse or minor children is/are currently appointed to or employed by any agency of the State of Illinois, and his/her annual salary exceeds 60% of the annual salary of the Governor, provide the name of your spouse and/or minor children, the name of the State agency for which he/she is employed and his/her annual salary. _____

3. If your spouse or any minor children is/are currently appointed to or employed by any agency of the State of Illinois, and his/her annual salary exceeds 60% of the annual salary of the Governor, as of 7/1/07) are you entitled to receive (i) more then 7 1/2% of the total distributable income of your firm, partnership, association or corporation, or (ii) an amount in excess of 100% of the annual salary of the Governor?
Yes ___ No ___

4. If your spouse or any minor children are currently appointed to or employed by any agency of the State of Illinois, and his/her annual salary exceeds 60% of the annual salary of the Governor, are you and your spouse or minor children entitled to receive (i) more than 15 % in the aggregate of the total distributable income of your firm, partnership, association or corporation, or (ii) an amount in excess of two times the annual salary of the Governor?
Yes ___ No ___

(c) Elective status; the holding of elective office of the State of Illinois, the government of the United States, any unit of local government authorized by the Constitution of the State of Illinois or the statutes of the State of Illinois currently or in the previous 3 years.
Yes ___ No ___

(d) Relationship to anyone holding elective office currently or in the previous 2 years; spouse, father, mother, son, or daughter.
Yes ___ No ___

(e) Appointive office; the holding of any appointive government office of the State of Illinois, the United States of America, or any unit of local government authorized by the Constitution of the State of Illinois or the statutes of the State of Illinois, which office entitles the holder to compensation in excess of the expenses incurred in the discharge of that office currently or in the previous 3 years.
Yes ___ No ___

(f) Relationship to anyone holding appointive office currently or in the previous 2 years; spouse, father, mother, son, or daughter.
Yes ___ No ___

(g) Employment, currently or in the previous 3 years, as or by any registered lobbyist of the State government.
Yes ___ No ___

RETURN WITH SUBCONTRACT

(h) Relationship to anyone who is or was a registered lobbyist in the previous 2 years; spouse, father, mother, son, or daughter. Yes ___ No ___

(i) Compensated employment, currently or in the previous 3 years, by any registered election or reelection committee registered with the Secretary of State or any county clerk of the State of Illinois, or any political action committee registered with either the Secretary of State or the Federal Board of Elections. Yes ___ No ___

(j) Relationship to anyone; spouse, father, mother, son, or daughter; who was a compensated employee in the last 2 years by any registered election or re-election committee registered with the Secretary of State or any county clerk of the State of Illinois, or any political action committee registered with either the Secretary of State or the Federal Board of Elections. Yes ___ No ___

3. Communication Disclosure.

Disclose the name and address of each lobbyist and other agent of the bidder or offeror who is not identified in Section 2 of this form, who is has communicated, is communicating, or may communicate with any State officer or employee concerning the bid or offer. This disclosure is a continuing obligation and must be promptly supplemented for accuracy throughout the process and throughout the term of the contract. If no person is identified, enter "None" on the line below:

Name and address of person(s): _____

RETURN WITH SUBCONTRACT

4. Debarment Disclosure. For each of the persons identified under Sections 2 and 3 of this form, disclose whether any of the following has occurred within the previous 10 years: debarment from contracting with any governmental entity; professional licensure discipline; bankruptcies; adverse civil judgments and administrative findings; and criminal felony convictions. This disclosure is a continuing obligation and must be promptly supplemented for accuracy throughout the procurement process and term of the contract. If no person is identified, enter "None" on the line below:

Name of person(s): _____

Nature of disclosure: _____

APPLICABLE STATEMENT

This Disclosure Form A is submitted on behalf of the INDIVIDUAL named on previous page. Under penalty of perjury, I certify the contents of this disclosure to be true and accurate to the best of my knowledge.

Completed by: _____ Date _____
Signature of Individual or Authorized Officer

NOT APPLICABLE STATEMENT

Under penalty of perjury, I have determined that no individuals associated with this organization meet the criteria that would require the completion of this Form A.

This Disclosure Form A is submitted on behalf of the SUBCONTRACTOR listed on the previous page.

_____ Date _____
Signature of Authorized Officer

RETURN WITH SUBCONTRACT

ILLINOIS DEPARTMENT
OF TRANSPORTATION

Form B
Subcontractor: Other Contracts &
Procurement Related Information
Disclosure

Subcontractor Name		
Legal Address		
City, State, Zip		
Telephone Number	Email Address	Fax Number (if available)

Disclosure of the information contained in this Form is required by the Section 50-35 of the Illinois Procurement Act (30 ILCS 500). This information shall become part of the publicly available contract file. This Form B must be completed for subcontracts with a total value of \$25,000 or more, from subcontractors identified in Section 20-120 of the Illinois Procurement Code, and for all open-ended contracts.

DISCLOSURE OF OTHER CONTRACTS, SUBCONTRACTS, AND PROCUREMENT RELATED INFORMATION

1. Identifying Other Contracts & Procurement Related Information. The SUBCONTRACTOR shall identify whether it has any pending contracts, subcontracts, including leases, bids, proposals, or other ongoing procurement relationship with any other State of Illinois agency: Yes ___ No ___

If **“No” is checked**, the subcontractor only needs to complete the signature box on the bottom of this page.

2. If “Yes” is checked. Identify each such relationship by showing State of Illinois agency name and other descriptive information such as bid or project number (attach additional pages as necessary). SEE DISCLOSURE FORM INSTRUCTIONS:

THE FOLLOWING STATEMENT MUST BE CHECKED

<input type="checkbox"/>	_____	_____
	Signature of Authorized Officer	Date



- 1. TIME AND PLACE OF OPENING BIDS.** Sealed proposals for the improvement described herein will be received by the Department of Transportation at the Harry R. Hanley Building, 2300 South Dirksen Parkway, in Springfield, Illinois until 10:00 o'clock a.m., March 9, 2012. All bids will be gathered, sorted, publicly opened and read in the auditorium at the Department of Transportation's Harry R. Hanley Building shortly after the 10:00 a.m. cut off time.
- 2. DESCRIPTION OF WORK.** The proposed improvement is identified and advertised for bids in the Invitation for Bids as:

**Contract No. 64H30
Various Counties
Section D2 GREENLIGHT 2012-2
Various Routes
District 2 Construction Funds**

Upgrading traffic signal heads with LED lights at various locations in Carroll, Lee, Stephenson, Rock Island and Whiteside Counties.

- 3. INSTRUCTIONS TO BIDDERS.** (a) This Notice, the invitation for bids, proposal and letter of award shall, together with all other documents in accordance with Article 101.09 of the Standard Specifications for Road and Bridge Construction, become part of the contract. Bidders are cautioned to read and examine carefully all documents, to make all required inspections, and to inquire or seek explanation of the same prior to submission of a bid.

(b) State law, and, if the work is to be paid wholly or in part with Federal-aid funds, Federal law requires the bidder to make various certifications as a part of the proposal and contract. By execution and submission of the proposal, the bidder makes the certification contained therein. A false or fraudulent certification shall, in addition to all other remedies provided by law, be a breach of contract and may result in termination of the contract.
- 4. AWARD CRITERIA AND REJECTION OF BIDS.** This contract will be awarded to the lowest responsive and responsible bidder considering conformity with the terms and conditions established by the Department in the rules, Invitation for Bids and contract documents. The issuance of plans and proposal forms for bidding based upon a prequalification rating shall not be the sole determinant of responsibility. The Department reserves the right to determine responsibility at the time of award, to reject any or all proposals, to readvertise the proposed improvement, and to waive technicalities.

By Order of the
Illinois Department of Transportation

Ann L. Schneider,
Secretary

INDEX
FOR
SUPPLEMENTAL SPECIFICATIONS
AND RECURRING SPECIAL PROVISIONS

Adopted January 1, 2012

This index contains a listing of SUPPLEMENTAL SPECIFICATIONS and frequently used RECURRING SPECIAL PROVISIONS.

SUPPLEMENTAL SPECIFICATIONS

Std. Spec. Sec.

Page
No.

No Supplemental Specifications this year.

RECURRING SPECIAL PROVISIONS

The following RECURRING SPECIAL PROVISIONS indicated by an "X" are applicable to this contract and are included by reference:

<u>CHECK SHEET #</u>	<u>PAGE NO.</u>
1	1
	Additional State Requirements for Federal-Aid Construction Contracts (Eff. 2-1-69) (Rev. 1-1-10)
2	4
	Subletting of Contracts (Federal-Aid Contracts) (Eff. 1-1-88) (Rev. 5-1-93)
3 X	5
	EEO (Eff. 7-21-78) (Rev. 11-18-80)
4 X	15
	Specific Equal Employment Opportunity Responsibilities Non Federal-Aid Contracts (Eff. 3-20-69) (Rev. 1-1-94)
5 X	20
	Required Provisions - State Contracts (Eff. 4-1-65) (Rev. 1-1-12)
6	25
	Asbestos Bearing Pad Removal (Eff. 11-1-03)
7	26
	Asbestos Waterproofing Membrane and Asbestos Hot-Mix Asphalt Surface Removal (Eff. 6-1-89) (Rev. 1-1-09)
8	27
	Haul Road Stream Crossings, Other Temporary Stream Crossings, and In-Stream Work Pads (Eff. 1-2-92) (Rev. 1-1-98)
9	28
	Construction Layout Stakes Except for Bridges (Eff. 1-1-99) (Rev. 1-1-07)
10	31
	Construction Layout Stakes (Eff. 5-1-93) (Rev. 1-1-07)
11	34
	Use of Geotextile Fabric for Railroad Crossing (Eff. 1-1-95) (Rev. 1-1-07)
12	36
	Subsealing of Concrete Pavements (Eff. 11-1-84) (Rev. 1-1-07)
13	40
	Hot-Mix Asphalt Surface Correction (Eff. 11-1-87) (Rev. 1-1-09)
14	42
	Pavement and Shoulder Resurfacing (Eff. 2-1-00) (Rev. 1-1-09)
15	43
	PCC Partial Depth Hot-Mix Asphalt Patching (Eff. 1-1-98) (Rev. 1-1-07)
16	45
	Patching with Hot-Mix Asphalt Overlay Removal (Eff. 10-1-95) (Rev. 1-1-07)
17	46
	Polymer Concrete (Eff. 8-1-95) (Rev. 1-1-08)
18	48
	PVC Pipeliner (Eff. 4-1-04) (Rev. 1-1-07)
19	49
	Pipe Underdrains (Eff. 9-9-87) (Rev. 1-1-07)
20	50
	Guardrail and Barrier Wall Delineation (Eff. 12-15-93) (Rev. 1-1-12)
21	54
	Bicycle Racks (Eff. 4-1-94) (Rev. 1-1-12)
22	56
	Temporary Modular Glare Screen System (Eff. 1-1-00) (Rev. 1-1-07)
23	58
	Temporary Portable Bridge Traffic Signals (Eff. 8-1-03) (Rev. 1-1-07)
24	60
	Work Zone Public Information Signs (Eff. 9-1-02) (Rev. 1-1-07)
25	61
	Night Time Inspection of Roadway Lighting (Eff. 5-1-96)
26	62
	English Substitution of Metric Bolts (Eff. 7-1-96)
27	63
	English Substitution of Metric Reinforcement Bars (Eff. 4-1-96) (Rev. 1-1-03)
28	64
	Calcium Chloride Accelerator for Portland Cement Concrete (Eff. 1-1-01)
29	65
	Portland Cement Concrete Inlay or Overlay for Pavements (Eff. 11-1-08) (Rev. 1-1-12)
30	68
	Quality Control of Concrete Mixtures at the Plant (Eff. 8-1-00) (Rev. 1-1-11)
31	76
	Quality Control/Quality Assurance of Concrete Mixtures (Eff. 4-1-92) (Rev. 1-1-11)

TABLE OF CONTENTS

TRAFFIC CONTROL PLAN.....	1
MAINTENANCE OF EXISTING TRAFFIC SIGNAL INSTALLATION	2
FULL-ACTUATED CONTROLLER AND TYPE IV CABINET.....	3
REBUILD EXISTING SIGNAL HEAD	4
SIGNAL HEAD, LED, RETROFIT.....	4
DISCONNECT SWITCH.....	4
LED SIGNAL FACE, LENS COVER	5
AGREEMENT TO PLAN QUANTITY (BDE).....	5
CONSTRUCTION AIR QUALITY - DIESEL VEHICLE EMISSIONS CONTROL (BDE)	5
CONSTRUCTION AIR QUALITY - IDLING RESTRICTIONS (BDE)	6
DISADVANTAGED BUSINESS ENTERPRISE PARTICIPATION (BDE)	7
PAYMENTS TO SUBCONTRACTORS (BDE).....	16
PAYROLLS AND PAYROLL RECORDS (BDE).....	17
SUBCONTRACTOR MOBILIZATION PAYMENTS (BDE).....	18
TRAFFIC CONTROL DEFICIENCY DEDUCTION (BDE).....	19
UTILITY COORDINATION AND CONFLICTS (BDE).....	19
WORKING DAYS (BDE).....	24

STATE OF ILLINOIS
SPECIAL PROVISIONS

The following Special Provisions supplement the "Standard Specifications for Road and Bridge Construction", adopted January 1, 2012, the latest edition of the "Manual on Uniform Traffic Control Devices for Streets and Highways" and the "Manual of Test Procedures for Materials" in effect on the date of invitation for bids, and the "Supplemental Specifications and Recurring Special Provisions" indicated on the Check Sheet included herein which apply to and govern the construction of Various Routes, Section D2 Greenlight 2012-2, in Various Counties, Contract 64H30 and in case of conflict with any part, or parts, of said Specifications, the said Special Provisions shall take precedence and shall govern.

LOCATION OF PROJECT

Various locations within Carroll, Lee, Whiteside, Rock Island and Stephenson Counties

DESCRIPTION OF PROJECT

Traffic signal lamps replacement with LED modules, UPS and various safety upgrades.

TRAFFIC CONTROL PLAN

Effective January 14, 1999

Traffic Control shall be according to the applicable sections of the Standard Specifications for Road and Bridge Construction, the applicable guidelines contained in the National Manual on Uniform Traffic Control Devices for Streets and Highways, Illinois Supplement to the National Manual on Uniform Traffic Control Devices, these special provisions, and any special details and Highway Standards contained herein and in the plans.

Special attention is called to Articles 107.09 and 107.14 of the Standard Specifications for Road and Bridge Construction and the following Highway Standards relating to traffic control.

Standards:

701101 701106 701406 701421 701701 701901
720001

Signs:

No bracing shall be allowed on post-mounted signs.

Post-mounted signs shall be installed using standard 720011, 728001, 729001, on 4" X 4" wood posts, or on any other "break away" connection if accepted by the FHWA and corresponding letter is provided to the resident.

All signs are required on both sides of the road when the median is greater than 10 feet and on one way roadways.

The "WORKERS" (W21-1a(O)-48) signs shall be replaced with symbol "Right or Left Lane Closed Ahead" (W4-2R or L(O)-48) signs on multilane sections with a lane closure.

A four way stop with minimum of 2 signs per leg shall be required during the removal and replacement of the Traffic Control cabinets at the intersection shown on the plans.

Pavement Marking:

All temporary pavement markings that will be operational during the winter months (December through March) shall be paint.

Devices:

A minimum of 3 drums spaced at 1.2 meters (4 feet) shall be placed at each return when the side road is open.

Vertical barricades shall not be allowed as a device.

Flaggers:

Flagger shall be required on all legs of the intersection for temporary lane closers.

The Contractor shall have all lanes open on weekends, unless prior approval is obtained from the Resident Engineer.

All workers shall wear pants and vests meeting ANSI Class 3 garment requirements during hours of darkness.

When replacing signal heads, close one (1) lane using Traffic Control and Protection 701701 & 701406. Side roads signal heads installation shall be completed using Traffic Control and Protection 701701.

Work Hour Restrictions:

1 Lane closure
M-W No closures 3-6
T-F No closures 1-6

No weekend closures

Full Closures allowed
11:00 PM to 5:00 AM

MAINTENANCE OF EXISTING TRAFFIC SIGNAL INSTALLATION

This work shall be in accordance with Section 850 of the current Standard and Specifications for road and Bridge Construction.

This work shall consist of maintaining an existing traffic signal installation that has been designated to remain in operation during modification.

Basis of Payment: This work will be paid for at the contract unit price per each being one (1) the percentages of the whole are shown on the summary of quantities. Each municipality has been pro-rated at a percentage for work being completed for **MAINTENANCE OF EXISTING TRAFFIC SIGNAL INSTALLATION.**

FULL-ACTUATED CONTROLLER AND TYPE IV CABINET

The controller shall conform to the specifications as stated in Section 857 of the "Standard Specifications for Road and Bridge Construction."

A separate 20-amp breaker shall be provided for a street light circuit.

The police door compartment shall contain a manual control cord which the signals may be operated manually. The inside door toggle switch shall be protected from accidental contact by vertical metal slats. The slats shall extend beyond the switches, in a manner similar to the terminals on the back panel. A plastic plans holder shall be installed on the cabinet door. The holder shall be at least 11 inches high by 17 inches wide, shall open from the side and shall not interfere with the filter. The holder shall have a means of closing the side opening to prevent water from entering.

A Plexiglas cover, or other high strength nonconductive cover, shall be installed over, and completely cover, the power panel. The cover shall completely shield the service wires, and circuit breaker wires from accidental contact.

A Plexiglas cover, or other high strength nonconductive cover, shall be installed over and completely cover, the power terminals for the thermostatically controlled exhaust fan. The thermostat shall be of the knob type capable of adjustment by hand and without tools. The thermostat and terminals shall be mounted on the left or right side of the controller cabinet.

The contractor shall have a factory-trained technician from the manufacturer and/or supplier, with expertise in the controllers being installed, present during the controller installation. He/She will be expected to be able to program the controller timer, trouble-shoot and correct any problems with the equipment that arises and verify that the equipment is functioning according to the plans and specifications.

The traffic signal controller and cabinet assembly shall be fully tested by the equipment supplier. The supplier of the controller assembly shall provide a Certificate of Acceptance verifying that the conflict monitor has been tested, under load, for all possible combinations and functions properly.

The cabinet shall have an aluminum finish.

Basis of Payment:

This item shall be paid for at the contract unit price each for **FULL-ACTUATED CONTROLLER AND TYPE IV CABINET**, which price shall be payment in full for furnishing the equipment described above and installing it in satisfactory operating condition.

MAINTENANCE OF TRAFFIC

The mainline shall be kept open to one-way traffic at all times during working hours and two-way traffic during non-working hours.

The Contractor shall have all lanes open on weekends, unless prior approval is obtained from the Resident Engineer.

REBUILD EXISTING SIGNAL HEAD

This work shall be consist of removing broken signal mounting brackets and the installation of signal head visors at the locations indicated on the Plans sheets and as directed by the resident engineer. This work shall be in accordance with Section 895 of the current "Standard Specifications for Road and Bridge Construction."

Basis of Payment:

This item shall be paid for at the contract unit price each (i.e. a visor counts as one, a bracket counts as one) for **REBUILD EXISTING SIGNAL HEAD**, which price shall be payment in full for furnishing the necessary labor, materials, and equipment necessary to complete the work described above and as shown on the plans.

SIGNAL HEAD, LED, RETROFIT

This work shall be to retrofit the existing traffic signal heads, as indicated on the plan sheets with LED sections. This work will require the removal of the existing signal section, optical units and replacing them with LED units as specified in the special provision for light emitting diode. This work shall include any parts and labor to install the LED unit to the satisfaction on the Resident Engineer.

Basis of Payment:

This item shall be paid for at contract unit price each lens (i.e. one five section signal head would be considered as 5 - each) for **SIGNAL HEAD, LED, RETROFIT**, which price shall be payment in full for furnishing the necessary labor, materials, and equipment necessary to complete the work described above and as shown on the plans.

DISCONNECT SWITCH

This work shall the removal and replacement of the disconnect switch at the intersection of IL 26 at Empire in Freeport. This work shall be in accordance with Article 1086.1 (a3) in the current "Standard Specifications for Road and Bridge Construction."

Basis of Payment:

This item shall be paid for at the contract unit price each for **DISCONNECT SWITCH**, which price shall be payment in full for furnishing the necessary labor, material and equipment necessary to complete the work described above and shown on plans.

LED SIGNAL FACE, LENS COVER

This work shall consist of the installation of LED lens covers on the LED signals locations as indicated on the plan sheets.

The Lens shall be less than 13 oz each and 100% UV Stabilized Virgin Polycarbonate. The "Snow Sentry" by FORTRAN is presently approved by District 2

Basis of Payment:

This item shall be paid for at the contract unit price each for **LED SIGNAL FACE, LENS COVER,**

This shall be payment in full for furnishing the parts and labor as describe above to the satisfaction the Resident Engineer.

AGREEMENT TO PLAN QUANTITY (BDE)

Effective: January 1, 2012

Revise the second paragraph of Article 202.07(a) of the Standard Specifications to read:

"When the plans or work have been altered, or when disagreement exists between the Contractor and the Engineer as to the accuracy of the plan quantities, either party shall, before any work is started which would affect the measurement, have the right to request in writing and thereby cause the quantities involved to be measured. When plan quantities are revised by the issuance of revised plan sheets that are made part of the contract, and the Contractor and the Engineer have agreed in writing that the revised quantities are accurate, no further measurement will be required and payment will be made for the revised quantities shown."

CONSTRUCTION AIR QUALITY - DIESEL VEHICLE EMISSIONS CONTROL (BDE)

Effective: April 1, 2009

Revised: January 2, 2012

Diesel Vehicle Emissions Control. The reduction of construction air emissions shall be accomplished by using cleaner burning diesel fuel. The term "equipment" refers to any and all diesel fuel powered devices rated at 50 hp and above, to be used on the project site in excess of seven calendar days over the course of the construction period on the project site (including any "rental" equipment).

All equipment on the jobsite, with engine ratings of 50 hp and above, shall be required to: use Ultra Low Sulfur Diesel fuel (ULSD) exclusively (15 ppm sulfur content or less).

Diesel powered equipment in non-compliance will not be allowed to be used on the project site, and is also subject to a notice of non-compliance as outlined below.

The Contractor shall certify that only ULSD will be used in all jobsite equipment. The certification shall be presented to the Department prior to the commencement of the work.

If any diesel powered equipment is found to be in non-compliance with any portion of this specification, the Engineer will issue the Contractor a notice of non-compliance and identify an appropriate period of time, as outlined below under environmental deficiency deduction, in which to bring the equipment into compliance or remove it from the project site.

Any costs associated with bringing any diesel powered equipment into compliance with these diesel vehicle emissions controls shall be considered as included in the contract unit prices bid for the various items of work involved and no additional compensation will be allowed. The Contractor's compliance with this notice and any associated regulations shall also not be grounds for a claim.

Environmental Deficiency Deduction. When the Engineer is notified, or determines that an environmental control deficiency exists, he/she will notify the Contractor in writing, and direct the Contractor to correct the deficiency within a specified time period. The specified time-period, which begins upon Contractor notification, will be from 1/2 hour to 24 hours long, based on the urgency of the situation and the nature of the deficiency. The Engineer shall be the sole judge regarding the time period.

The deficiency will be based on lack of repair, maintenance and diesel vehicle emissions control.

If the Contractor fails to correct the deficiency within the specified time frame, a daily monetary deduction will be imposed for each calendar day or fraction thereof the deficiency continues to exist. The calendar day(s) will begin when the time period for correction is exceeded and end with the Engineer's written acceptance of the correction. The daily monetary deduction will be \$1,000.00 for each deficiency identified.

If a Contractor or subcontractor accumulates three environmental deficiency deductions in a contract period, the Contractor will be shutdown until the deficiency is corrected. Such a shutdown will not be grounds for any extension of contract time, waiver of penalties, or be grounds for any claim.

CONSTRUCTION AIR QUALITY - IDLING RESTRICTIONS (BDE)

Effective: April 1, 2009

Idling Restrictions. The Contractor shall establish truck-staging areas for all diesel powered vehicles that are waiting to load or unload material at the jobsite. Staging areas shall be located where the diesel emissions from the equipment will have a minimum impact on adjacent sensitive receptors. The Department will review the selection of staging areas, whether within or outside the existing highway right-of-way, to avoid locations near sensitive areas or populations to the extent possible. Sensitive receptors include, but are not limited to, hospitals, schools, residences, motels, hotels, daycare facilities, elderly housing and convalescent facilities. Diesel powered engines shall also be located as far away as possible from fresh air intakes, air conditioners, and windows. The Engineer will approve staging areas before implementation.

Diesel powered vehicle operators may not cause or allow the motor vehicle, when it is not in motion, to idle for more than a total of 10 minutes within any 60 minute period, except under any of the following circumstances:

- 1) The motor vehicle has a gross vehicle weight rating of less than 8000 lb (3630 kg).
- 2) The motor vehicle idles while forced to remain motionless because of on-highway traffic, an official traffic control device or signal, or at the direction of a law enforcement official.
- 3) The motor vehicle idles when operating defrosters, heaters, air conditioners, or other equipment solely to prevent a safety or health emergency.
- 4) A police, fire, ambulance, public safety, other emergency or law enforcement motor vehicle, or any motor vehicle used in an emergency capacity, idles while in an emergency or training mode and not for the convenience of the vehicle operator.
- 5) The primary propulsion engine idles for maintenance, servicing, repairing, or diagnostic purposes if idling is necessary for such activity.
- 6) A motor vehicle idles as part of a government inspection to verify that all equipment is in good working order, provided idling is required as part of the inspection.
- 7) When idling of the motor vehicle is required to operate auxiliary equipment to accomplish the intended use of the vehicle (such as loading, unloading, mixing, or processing cargo; controlling cargo temperature; construction operations, lumbering operations; oil or gas well servicing; or farming operations), provided that this exemption does not apply when the vehicle is idling solely for cabin comfort or to operate non-essential equipment such as air conditioning, heating, microwave ovens, or televisions.
- 8) When the motor vehicle idles due to mechanical difficulties over which the operator has no control.
- 9) The outdoor temperature is less than 32 °F (0 °C) or greater than 80 °F (26 °C).

When the outdoor temperature is greater than or equal to 32 °F (0 °C) or less than or equal to 80 °F (26 °C), a person who operates a motor vehicle operating on diesel fuel shall not cause or allow the motor vehicle to idle for a period greater than 30 minutes in any 60 minute period while waiting to weigh, load, or unload cargo or freight, unless the vehicle is in a line of vehicles that regularly and periodically moves forward.

The above requirements do not prohibit the operation of an auxiliary power unit or generator set as an alternative to idling the main engine of a motor vehicle operating on diesel fuel.

Environmental Deficiency Deduction. When the Engineer is notified, or determines that an environmental control deficiency exists based on non-compliance with the idling restrictions, he/she will notify the Contractor, and direct the Contractor to correct the deficiency.

If the Contractor fails to correct the deficiency a monetary deduction will be imposed. The monetary deduction will be \$1,000.00 for each deficiency identified.

DISADVANTAGED BUSINESS ENTERPRISE PARTICIPATION (BDE)

Effective: September 1, 2000

Revised: August 2, 2011

FEDERAL OBLIGATION. The Department of Transportation, as a recipient of federal financial assistance, is required to take all necessary and reasonable steps to ensure nondiscrimination in the award and administration of contracts.

Consequently, the federal regulatory provisions of 49 CFR Part 26 apply to this contract concerning the utilization of disadvantaged business enterprises. For the purposes of this Special Provision, a disadvantaged business enterprise (DBE) means a business certified by the Department in accordance with the requirements of 49 CFR Part 26 and listed in the Illinois Unified Certification Program (IL UCP) DBE Directory.

STATE OBLIGATION. This Special Provision will also be used by the Department to satisfy the requirements of the Business Enterprise for Minorities, Females, and Persons with Disabilities Act, 30 ILCS 575. When this Special Provision is used to satisfy state law requirements on 100 percent state-funded contracts, the federal government has no involvement in such contracts (not a federal-aid contract) and no responsibility to oversee the implementation of this Special Provision by the Department on those contracts. DBE participation on 100 percent state-funded contracts will not be credited toward fulfilling the Department's annual overall DBE goal required by the US Department of Transportation to comply with the federal DBE program requirements.

CONTRACTOR ASSURANCE. The Contractor makes the following assurance and agrees to include the assurance in each subcontract that the Contractor signs with a subcontractor.

The Contractor, subrecipient, or subcontractor shall not discriminate on the basis of race, color, national origin, or sex in the performance of this contract. The Contractor shall carry out applicable requirements of 49 CFR Part 26 in the award and administration of contracts funded in whole or in part with federal or state funds. Failure by the Contractor to carry out these requirements is a material breach of this contract, which may result in the termination of this contract or such other remedy as the recipient deems appropriate.

OVERALL GOAL SET FOR THE DEPARTMENT. As a requirement of compliance with 49 CFR Part 26, the Department has set an overall goal for DBE participation in its federally assisted contracts. That goal applies to all federal-aid funds the Department will expend in its federally assisted contracts for the subject reporting fiscal year. The Department is required to make a good faith effort to achieve the overall goal. The dollar amount paid to all approved DBE companies performing work called for in this contract is eligible to be credited toward fulfillment of the Department's overall goal.

CONTRACT GOAL TO BE ACHIEVED BY THE CONTRACTOR. This contract includes a specific DBE utilization goal established by the Department. The goal has been included because the Department has determined that the work of this contract has subcontracting opportunities that may be suitable for performance by DBE companies. The determination is based on an assessment of the type of work, the location of the work, and the availability of DBE companies to do a part of the work. The assessment indicates that, in the absence of unlawful discrimination, and in an arena of fair and open competition, DBE companies can be expected to perform **0.00%** of the work. This percentage is set as the DBE participation goal for this contract. Consequently, in addition to the other award criteria established for this contract, the Department will only award this contract to a bidder who makes a good faith effort to meet this goal of DBE participation in the performance of the work. A bidder makes a good faith effort for award consideration if either of the following is done in accordance with the procedures set for in this Special Provision:

- (a) The bidder documents that enough DBE participation has been obtained to meet the goal: or

- (b) The bidder documents that a good faith effort has been made to meet the goal, even though the effort did not succeed in obtaining enough DBE participation to meet the goal.

DBE LOCATOR REFERENCES. Bidders shall consult the IL UCP DBE Directory as a reference source for DBE-certified companies. In addition, the Department maintains a letting and item specific DBE locator information system whereby DBE companies can register their interest in providing quotes on particular bid items advertised for letting. Information concerning DBE companies willing to quote work for particular contracts may be obtained by contacting the Department's Bureau of Small Business Enterprises at telephone number (217)785-4611, or by visiting the Department's website at www.dot.il.gov.

BIDDING PROCEDURES. Compliance with this Special Provision is a material bidding requirement. The failure of the bidder to comply will render the bid not responsive.

- (a) The bidder shall submit a Disadvantaged Business Utilization Plan on Department forms SBE 2025 and 2026 with the bid.
- (b) The Utilization Plan shall indicate that the bidder either has obtained sufficient DBE participation commitments to meet the contract goal or has not obtained enough DBE participation commitments in spite of a good faith effort to meet the goal. The Utilization Plan shall further provide the name, telephone number, and telefax number of a responsible official of the bidder designated for purposes of notification of plan approval or disapproval under the procedures of this Special Provision.
- (c) The Utilization Plan shall include a DBE Participation Commitment Statement, Department form SBE 2025, for each DBE proposed for the performance of work to achieve the contract goal. For bidding purposes, submission of the completed SBE 2025 forms, signed by the DBEs and faxed to the bidder will be acceptable as long as the original is available and provided upon request. All elements of information indicated on the said form shall be provided, including but not limited to the following:
- (1) The names and addresses of DBE firms that will participate in the contract;
 - (2) A description, including pay item numbers, of the work each DBE will perform;
 - (3) The dollar amount of the participation of each DBE firm participating. The dollar amount of participation for identified work shall specifically state the quantity, unit price, and total subcontract price for the work to be completed by the DBE. If partial pay items are to be performed by the DBE, indicate the portion of each item, a unit price where appropriate and the subcontract price amount;
 - (4) DBE Participation Commitment Statements, form SBE 2025, signed by the bidder and each participating DBE firm documenting the commitment to use the DBE subcontractors whose participation is submitted to meet the contract goal;
 - (5) if the bidder is a joint venture comprised of DBE companies and non-DBE companies, the plan must also include a clear identification of the portion of the work to be performed by the DBE partner(s); and,

- (6) If the contract goal is not met, evidence of good faith efforts.

GOOD FAITH EFFORT PROCEDURES. The contract will not be awarded until the Utilization Plan submitted by the apparent successful bidder is approved. All information submitted by the bidder must be complete, accurate and adequately document that enough DBE participation has been obtained or document that good faith efforts of the bidder, in the event enough DBE participation has not been obtained, before the Department will commit to the performance of the contract by the bidder. The Utilization Plan will be approved by the Department if the Utilization Plan documents sufficient commercially useful DBE work performance to meet the contract goal or the bidder submits sufficient documentation of a good faith effort to meet the contract goal pursuant to 49 CFR Part 26, Appendix A. The Utilization Plan will not be approved by the Department if the Utilization Plan does not document sufficient DBE participation to meet the contract goal unless the apparent successful bidder documented in the Utilization Plan that it made a good faith effort to meet the goal. This means that the bidder must show that all necessary and reasonable steps were taken to achieve the contract goal. Necessary and reasonable steps are those which, by their scope, intensity and appropriateness to the objective, could reasonably be expected to obtain sufficient DBE participation, even if they were not successful. The Department will consider the quality, quantity, and intensity of the kinds of efforts that the bidder has made. Mere *pro forma* efforts, in other words, efforts done as a matter of form, are not good faith efforts; rather, the bidder is expected to have taken genuine efforts that would be reasonably expected of a bidder actively and aggressively trying to obtain DBE participation sufficient to meet the contract goal.

- (a) The following is a list of types of action that the Department will consider as part of the evaluation of the bidder's good faith efforts to obtain participation. These listed factors are not intended to be a mandatory checklist and are not intended to be exhaustive. Other factors or efforts brought to the attention of the Department may be relevant in appropriate cases, and will be considered by the Department.
- (1) Soliciting through all reasonable and available means (e.g. attendance at pre-bid meetings, advertising and/or written notices) the interest of all certified DBE companies that have the capability to perform the work of the contract. The bidder must solicit this interest within sufficient time to allow the DBE companies to respond to the solicitation. The bidder must determine with certainty if the DBE companies are interested by taking appropriate steps to follow up initial solicitations.
 - (2) Selecting portions of the work to be performed by DBE companies in order to increase the likelihood that the DBE goals will be achieved. This includes, where appropriate, breaking out contract work items into economically feasible units to facilitate DBE participation, even when the prime Contractor might otherwise prefer to perform these work items with its own forces.
 - (3) Providing interested DBE companies with adequate information about the plans, specifications, and requirements of the contract in a timely manner to assist them in responding to a solicitation.
 - (4) a. Negotiating in good faith with interested DBE companies. It is the bidder's responsibility to make a portion of the work available to DBE subcontractors and suppliers and to select those portions of the work or material needs consistent with the available DBE subcontractors and suppliers, so as to facilitate DBE participation.

Evidence of such negotiation includes the names, addresses, and telephone numbers of DBE companies that were considered; a description of the information provided regarding the plans and specifications for the work selected for subcontracting; and evidence as to why additional agreements could not be reached for DBE companies to perform the work.

- b. A bidder using good business judgment would consider a number of factors in negotiating with subcontractors, including DBE subcontractors, and would take a firm's price and capabilities as well as contract goals into consideration. However, the fact that there may be some additional costs involved in finding and using DBE companies is not in itself sufficient reason for a bidder's failure to meet the contract DBE goal, as long as such costs are reasonable. Also the ability or desire of a bidder to perform the work of a contract with its own organization does not relieve the bidder of the responsibility to make good faith efforts. Bidders are not, however, required to accept higher quotes from DBE companies if the price difference is excessive or unreasonable.
- (5) Not rejecting DBE companies as being unqualified without sound reasons based on a thorough investigation of their capabilities. The bidder's standing within its industry, membership in specific groups, organizations, or associations and political or social affiliations (for example union vs. non-union employee status) are not legitimate causes for the rejection or non-solicitation of bids in the bidder's efforts to meet the project goal.
 - (6) Making efforts to assist interested DBE companies in obtaining bonding, lines of credit, or insurance as required by the recipient or Contractor.
 - (7) Making efforts to assist interested DBE companies in obtaining necessary equipment, supplies, materials, or related assistance or services.
 - (8) Effectively using the services of available minority/women community organizations; minority/women contractors' groups; local, state, and federal minority/women business assistance offices; and other organizations as allowed on a case-by-case basis to provide assistance in the recruitment and placement of DBE companies.
- (b) If the Department determines that the apparent successful bidder has made a good faith effort to secure the work commitment of DBE companies to meet the contract goal, the Department will award the contract provided that it is otherwise eligible for award. If the Department determines that the bidder has failed to meet the requirements of this Special Provision or that a good faith effort has not been made, the Department will notify the responsible company official designated in the Utilization Plan that the bid is not responsive. The notification shall include a statement of reasons for the determination.
 - (c) The bidder may request administrative reconsideration of a determination adverse to the bidder within the five working days after the receipt of the notification date of the determination by delivering the request to the Department of Transportation, Bureau of Small Business Enterprises, Contract Compliance Section, 2300 South Dirksen Parkway, Room 319, Springfield, Illinois 62764 (Telefax: (217)785-1524). Deposit of the request in the United States mail on or before the fifth business day shall not be deemed delivery.

The determination shall become final if a request is not made and delivered. A request may provide additional written documentation and/or argument concerning the issues raised in the determination statement of reasons, provided the documentation and arguments address efforts made prior to submitting the bid. The request will be forwarded to the Department's Reconsideration Officer. The Reconsideration Officer will extend an opportunity to the bidder to meet in person in order to consider all issues of documentation and whether the bidder made a good faith effort to meet the goal. After the review by the Reconsideration Officer, the bidder will be sent a written decision within ten working days after receipt of the request for consideration, explaining the basis for finding that the bidder did or did not meet the goal or make adequate good faith efforts to do so. A final decision by the Reconsideration Officer that a good faith effort was made shall approve the Utilization Plan submitted by the bidder and shall clear the contract for award. A final decision that a good faith effort was not made shall render the bid not responsive.

CALCULATING DBE PARTICIPATION. The Utilization Plan values represent work anticipated to be performed and paid for upon satisfactory completion. The Department is only able to count toward the achievement of the overall goal and the contract goal the value of payments made for the work actually performed by DBE companies. In addition, a DBE must perform a commercially useful function on the contract to be counted. A commercially useful function is generally performed when the DBE is responsible for the work and is carrying out its responsibilities by actually performing, managing, and supervising the work involved. The Department and Contractor are governed by the provisions of 49 CFR Part 26.55(c) on questions of commercially useful functions as it affects the work. Specific counting guidelines are provided in 49 CFR Part 26.55, the provisions of which govern over the summary contained herein.

- (a) DBE as the Contractor: 100 percent goal credit for that portion of the work performed by the DBE's own forces, including the cost of materials and supplies. Work that a DBE subcontracts to a non-DBE does not count toward the DBE goals.
- (b) DBE as a joint venture Contractor: 100 percent goal credit for that portion of the total dollar value of the contract equal to the distinct, clearly defined portion of the work performed by the DBE's own forces.
- (c) DBE as a subcontractor: 100 percent goal credit for the work of the subcontract performed by the DBE's own forces, including the cost of materials and supplies, excluding the purchase of materials and supplies or the lease of equipment by the DBE subcontractor from the prime Contractor or its affiliates. Work that a DBE subcontractor in turn subcontracts to a non-DBE does not count toward the DBE goal.
- (d) DBE as a trucker: 100 percent goal credit for trucking participation provided the DBE is responsible for the management and supervision of the entire trucking operation for which it is responsible.

At least one truck owned, operated, licensed, and insured by the DBE must be used on the contract. Credit will be given for the following:

- (1) The DBE may lease trucks from another DBE firm, including an owner-operator who is certified as a DBE.

The DBE who leases trucks from another DBE receives credit for the total value of the transportation services the lessee DBE provides on the contract.

- (2) The DBE may also lease trucks from a non-DBE firm, including from an owner-operator. The DBE who leases trucks from a non-DBE is entitled to credit only for the fee or commission is receives as a result of the lease arrangement.

(e) DBE as a material supplier:

- (1) 60 percent goal credit for the cost of the materials or supplies purchased from a DBE regular dealer.
- (2) 100 percent goal credit for the cost of materials of supplies obtained from a DBE manufacturer.
- (3) 100 percent credit for the value of reasonable fees and commissions for the procurement of materials and supplies if not a regular dealer or manufacturer.

CONTRACT COMPLIANCE. Compliance with this Special Provision is an essential part of the contract. The Department is prohibited by federal regulations from crediting the participation of a DBE included in the Utilization Plan toward either the contract goal or the Department's overall goal until the amount to be applied toward the goals has been paid to the DBE. The following administrative procedures and remedies govern the compliance by the Contractor with the contractual obligations established by the Utilization Plan. After approval of the Utilization Plan and award of the contract, the Utilization Plan and individual DBE Participation Statements become part of the contract. If the Contractor did not succeed in obtaining enough DBE participation to achieve the advertised contract goal, and the Utilization Plan was approved and contract awarded based upon a determination of good faith, the total dollar value of DBE work calculated in the approved Utilization Plan as a percentage of the awarded contract value shall become the amended contract goal. All work indicated for performance by an approved DBE shall be performed, managed, and supervised by the DBE executing the Participation Statement.

- (a) **NO AMENDMENT.** No amendment to the Utilization Plan may be made without prior written approval from the Department's Bureau of Small Business Enterprises. All requests for amendment to the Utilization Plan shall be submitted to the Department of Transportation, Bureau of Small Business Enterprises, Contract Compliance Section, 2300 South Dirksen Parkway, Room 319, Springfield, Illinois 62764. Telephone number (217)785-4611. Telefax number (217)785-1524.
- (b) **TERMINATION OR REPLACEMENT.** The Contractor shall not terminate or replace a DBE listed on the approved Utilization Plan, or perform with other forces work designated for a listed DBE except as provided in the Special Provision.
- (c) **CHANGES TO WORK.** Any deviation from the DBE condition-of-award or contract plans, specifications, or special provisions must be approved, in writing, by the Department as provided elsewhere in the Contract. The Contractor shall notify affected DBEs in writing of any changes in the scope of work which result in a reduction in the dollar amount condition-of-award to the contract.

Where the revision includes work committed to a new DBE subcontractor, not previously involved in the project, then a Request for Approval of Subcontractor, Department form BC 260A, must be signed and submitted. If the commitment of work is in the form of additional tasks assigned to an existing subcontract, than a new Request for Approval of Subcontractor shall not be required. However, the Contractor must document efforts to assure that the existing DBE subcontractor is capable of performing the additional work and has agreed in writing to the change.

(d) ALTERNATIVE WORK METHODS. In addition to the above requirements for reductions in the condition of award, additional requirements apply to the two cases of Contractor-initiated work substitution proposals. Where the contract allows alternate work methods which serve to delete or create underruns in condition of award DBE work, and the Contractor selects that alternate method or, where the Contractor proposes a substitute work method or material that serves to diminish or delete work committed to a DBE and replace it with other work, then the Contractor must demonstrate one of the following:

- (1) That the replacement work will be performed by the same DBE (as long as the DBE is certified in the respective item of work) in a modification of the condition of award; or
- (2) That the DBE is aware that its work will be deleted or will experience underruns and has agreed in writing to the change. If this occurs, the Contractor shall substitute other work of equivalent value to a certified DBE or provide documentation of good faith efforts to do so; or
- (3) That the DBE is not capable of performing the replacement work or has declined to perform the work at a reasonable competitive price. If this occurs, the Contractor shall substitute other work of equivalent value to a certified DBE or provide documentation of good faith efforts to do so.

(e) TERMINATION AND REPLACEMENT PROCEDURES. The Contractor shall not terminate or replace a DBE subcontractor listed in the approved Utilization Plan without prior written consent. This includes, but is not limited to, instances in which the Contractor seeks to perform work originally designated for a DBE subcontractor with its own forces or those of an affiliate, a non-DBE firm, or with another DBE firm. Written consent will be granted only if the Bureau of Small Business Enterprises agrees, for reasons stated in its concurrence document, that the Contractor has good cause to terminate or replace the DBE firm. Before transmitting to the Bureau of Small Business Enterprises any request to terminate and/or substitute a DBE subcontractor, the Contractor shall give notice in writing to the DBE subcontractor, with a copy to the Bureau, of its intent to request to terminate and/or substitute, and the reason for the request. The Contractor shall give the DBE five days to respond to the Contractor's notice.

The DBE so notified shall advise the Bureau and the Contractor of the reasons, if any, why it objects to the proposed termination of its subcontract and why the Bureau should not approve the Contractor's action. If required in a particular case as a matter of public necessity, the Bureau may provide a response period shorter than five days.

For purposes of this paragraph, good cause includes the following circumstances:

- (1) The listed DBE subcontractor fails or refuses to execute a written contract;
- (2) The listed DBE subcontractor fails or refuses to perform the work of its subcontract in a way consistent with normal industry standards. Provided, however, that good cause does not exist if the failure or refusal of the DBE subcontractor to perform its work on the subcontract results from the bad faith or discriminatory action of the prime contractor;
- (3) The listed DBE subcontractor fails or refuses to meet the prime Contractor's reasonable, nondiscriminatory bond requirements;
- (4) The listed DBE subcontractor becomes bankrupt, insolvent, or exhibits credit unworthiness;
- (5) The listed DBE subcontractor is ineligible to work on public works projects because of suspension and debarment proceedings pursuant 2 CFR Parts 180, 215 and 1,200 or applicable state law.
- (6) You have determined that the listed DBE subcontractor is not a responsible contractor;
- (7) The listed DBE subcontractor voluntarily withdraws from the projects and provides to you written notice of its withdrawal;
- (8) The listed DBE is ineligible to receive DBE credit for the type of work required;
- (9) A DBE owner dies or becomes disabled with the result that the listed DBE contractor is unable to complete its work on the contract;
- (10) Other documented good cause that compels the termination of the DBE subcontractor. Provided, that good cause does not exist if the prime Contractor seeks to terminate a DBE it relied upon to obtain the contract so that the prime Contractor can self-perform the work for which the DBE contractor was engaged or so that the prime Contractor can substitute another DBE or non-DBE contractor after contract award.

When a DBE is terminated, or fails to complete its work on the Contract for any reason the Contractor shall make a good faith effort to find another DBE to substitute for the original DBE to perform at least the same amount of work under the contract as the terminated DBE to the extent needed to meet the established Contract goal.

- (f) PAYMENT RECORDS. The Contractor shall maintain a record of payments for work performed to the DBE participants. The records shall be made available to the Department for inspection upon request.

After the performance of the final item of work or delivery of material by a DBE and final payment therefore to the DBE by the Contractor, but not later than thirty calendar days after payment has been made by the Department to the Contractor for such work or material, the Contractor shall submit a DBE Payment Agreement on Department form SBE 2115 to the Regional Engineer. If full and final payment has not been made to the DBE, the DBE Payment Agreement shall indicate whether a disagreement as to the payment required exists between the Contractor and the DBE or if the Contractor believes that the work has not been satisfactorily completed. If the Contractor does not have the full amount of work indicated in the Utilization Plan performed by the BDE companies indicated in the Utilization Plan and after good faith efforts are reviewed, the Department may deduct from contract payments to the Contractor the amount of the goal not achieved as liquidated and ascertained damages. The Contractor may request an administrative reconsideration of any amount deducted as damages pursuant to subsection (h) of this part.

- (g) **ENFORCEMENT**. The Department reserves the right to withhold payment to the Contractor to enforce the provisions of this Special Provision. Final payment shall not be made on the contract until such time as the Contractor submits sufficient documentation demonstrating achievement of the goal in accordance with this Special Provision or after liquidated damages have been determined and collected.
- (h) **RECONSIDERATION**. Notwithstanding any other provision of the contract, including but not limited to Article 109.09 of the Standard Specifications, the Contractor may request administrative reconsideration of a decision to deduct the amount of the goal not achieved as liquidated damages. A request to reconsider shall be delivered to the Contract Compliance Section and shall be handled and considered in the same manner as set forth in paragraph (c) of "Good Faith Effort Procedures" of this Special Provision, except a final decision that a good faith effort was not made during contract performance to achieve the goal agreed to in the Utilization Plan shall be the final administrative decision of the Department.

PAYMENTS TO SUBCONTRACTORS (BDE)

Effective: June 1, 2000

Revised: January 1, 2006

Federal regulations found at 49 CFR §26.29 mandate the Department to establish a contract clause to require Contractors to pay subcontractors for satisfactory performance of their subcontracts and to set the time for such payments.

State law also addresses the timing of payments to be made to subcontractors and material suppliers. Section 7 of the Prompt Payment Act, 30 ILCS 540/7, requires that when a Contractor receives any payment from the Department, the Contractor shall make corresponding, proportional payments to each subcontractor and material supplier performing work or supplying material within 15 calendar days after receipt of the Department payment. Section 7 of the Act further provides that interest in the amount of two percent per month, in addition to the payment due, shall be paid to any subcontractor or material supplier by the Contractor if the payment required by the Act is withheld or delayed without reasonable cause.

The Act also provides that the time for payment required and the calculation of any interest due applies to transactions between subcontractors and lower-tier subcontractors and material suppliers throughout the contracting chain.

This Special Provision establishes the required federal contract clause, and adopts the 15 calendar day requirement of the State Prompt Payment Act for purposes of compliance with the federal regulation regarding payments to subcontractors. This contract is subject to the following payment obligations.

When progress payments are made to the Contractor according to Article 109.07 of the Standard Specifications, the Contractor shall make a corresponding payment to each subcontractor and material supplier in proportion to the work satisfactorily completed by each subcontractor and for the material supplied to perform any work of the contract. The proportionate amount of partial payment due to each subcontractor and material supplier throughout the contracting chain shall be determined by the quantities measured or otherwise determined as eligible for payment by the Department and included in the progress payment to the Contractor. Subcontractors and material suppliers shall be paid by the Contractor within 15 calendar days after the receipt of payment from the Department. The Contractor shall not hold retainage from the subcontractors. These obligations shall also apply to any payments made by subcontractors and material suppliers to their subcontractors and material suppliers; and to all payments made to lower tier subcontractors and material suppliers throughout the contracting chain. Any payment or portion of a payment subject to this provision may only be withheld from the subcontractor or material supplier to whom it is due for reasonable cause.

This Special Provision does not create any rights in favor of any subcontractor or material supplier against the State or authorize any cause of action against the State on account of any payment, nonpayment, delayed payment, or interest claimed by application of the State Prompt Payment Act. The Department will not approve any delay or postponement of the 15 day requirement except for reasonable cause shown after notice and hearing pursuant to Section 7(b) of the State Prompt Payment Act. State law creates other and additional remedies available to any subcontractor or material supplier, regardless of tier, who has not been paid for work properly performed or material furnished. These remedies are a lien against public funds set forth in Section 23(c) of the Mechanics Lien Act, 770 ILCS 60/23(c), and a recovery on the Contractor's payment bond according to the Public Construction Bond Act, 30 ILCS 550.

PAYROLLS AND PAYROLL RECORDS (BDE)

Effective: January 2, 2012

Revise Section IV of Check Sheet #5 of the Recurring Special Provisions to read:

"IV.COMPLIANCE WITH THE PREVAILING WAGE ACT

1. **Prevailing Wages.** All wages paid by the Contractor and each subcontractor shall be in compliance with The Prevailing Wage Act (820 ILCS 130), as amended, except where a prevailing wage violates a federal law, order, or ruling, the rate conforming to the federal law, order, or ruling shall govern. The Contractor shall be responsible to notify each subcontractor of the wage rates set forth in this contract and any revisions thereto.

If the Department of Labor revises the wage rates, the Contractor will not be allowed additional compensation on account of said revisions.

2. Payroll Records. The Contractor and each subcontractor shall make and keep, for a period of three years from the later of the date of final payment under the contract or completion of the contract, records of the wages paid to his/her workers. The payroll records shall include each worker's name, address, telephone number, social security number, classification, rate of pay, number of hours worked each day, starting and ending times of work each day, total hours worked each week, itemized deductions made, and actual wages paid. Upon seven business days' notice, these records shall be available at a location within the State, during reasonable hours, for inspection by the Department; the Department of Labor; and Federal, State or local law enforcement agencies and prosecutors.
3. Submission of Payroll Records. The Contractor and each subcontractor shall submit payroll records to the Engineer each week from the start to the completion of their respective work, except that full social security numbers and home addresses shall not be included on weekly transmittals. Instead the payrolls shall include an identification number for each employee (e.g., the last four digits of the employee's social security number). In addition, starting and ending times of work each day may be omitted from the payroll records submitted to the Engineer. The submittals shall be on the Department's form SBE 48, or an approved facsimile. When there has been no activity during a work week, a payroll record shall still be submitted with the appropriate box ("No Work", "Suspended", or "Complete") checked on the form.

Each submittal shall be accompanied by a statement signed by the Contractor or subcontractor, or an officer, employee or officer thereof, which avers that: (i) he or she has examined the records and such records are true and accurate; (ii) the hourly rate paid to each worker is not less than the general prevailing rate of hourly wages required by the Act; and (iii) the Contractor or subcontractor is aware that filing a payroll record that he/she knows to be false is a Class A misdemeanor.

4. Employee Interviews. The Contractor and each subcontractor shall permit his/her employees to be interviewed on the job, during working hours, by compliance investigators of the Department or the Department of Labor."

SUBCONTRACTOR MOBILIZATION PAYMENTS (BDE)

Effective: April 2, 2005

Revised: April 1, 2011

To account for the preparatory work and operations necessary for the movement of subcontractor personnel, equipment, supplies, and incidentals to the project site and for all other work or operations that must be performed or costs incurred when beginning work approved for subcontracting according to Article 108.01 of the Standard Specifications, the Contractor shall make a mobilization payment to each subcontractor.

This mobilization payment shall be made at least 14 days prior to the subcontractor starting work. The amount paid shall be equal to 3 percent of the amount of the subcontract reported on form BC 260A submitted for the approval of the subcontractor's work.

The mobilization payment to the subcontractor is an advance payment of the reported amount of the subcontract and is not a payment in addition to the amount of the subcontract; therefore, the amount of the advance payment will be deducted from future progress payments.

This provision shall be incorporated directly or by reference into each subcontract approved by the Department.

TRAFFIC CONTROL DEFICIENCY DEDUCTION (BDE)

Effective: August 1, 2011

Revise the third sentence of the third paragraph of Article 105.03(b) of the Standard Specifications to read:

“The daily monetary deduction will be \$2,500.”

UTILITY COORDINATION AND CONFLICTS (BDE)

Effective: April 1, 2011

Revised: January 1, 2012

Revise Article 105.07 of the Standard Specifications to read:

“**105.07 Cooperation with Utilities.** The Department reserves the right at any time to allow work by utilities on or near the work covered by the contract. The Contractor shall conduct his/her work so as not to interfere with or hinder the progress or completion of the work being performed by utilities. The Contractor shall also arrange the work and shall place and dispose of the materials being used so as not to interfere with the operations of utility work in the area.

The Contractor shall cooperate with the owners of utilities in their removal and rearrangement operations so work may progress in a reasonable manner, duplication or rearrangement of work may be reduced to a minimum, and services rendered by those parties will not be unnecessarily interrupted.

The Contractor shall coordinate with any planned utility adjustment or new installation and the Contractor shall take all precautions to prevent disturbance or damage to utility facilities. Any failure on the part of the utility owner, or their representative, to proceed with any planned utility adjustment or new installation shall be reported promptly by the Contractor to the Engineer.”

Revise the first sentence of the last paragraph of Article 107.19 of the Standard Specifications to read:

“When the Contractor encounters unexpected regulated substances due to the presence of utilities in unanticipated locations, the provisions of Article 107.40 shall apply; otherwise, if the Engineer does not direct a resumption of operations, the provisions of Article 108.07 shall apply.”

Revise Article 107.31 of the Standard Specification to read:

“107.31 Reserved.”

Add the following four Articles to Section 107 of the Standard Specifications:

“107.37 Locations of Utilities within the Project Limits. All known utilities existing within the limits of construction are either indicated on the plans or visible above ground. For the purpose of this Article, the limits of proposed construction are defined as follows:

(a) Limits of Proposed Construction for Utilities Paralleling the Roadway.

- (1) The horizontal limits shall be a vertical plane, outside of, parallel to, and 2 ft (600 mm) distant at right angles from the plan or revised slope limits.

In cases where the limits of excavation for structures are not shown on the plans, the horizontal limits shall be a vertical plane 4 ft (1.2 m) outside the edges of structure footings or the structure where no footings are required.

- (2) The upper vertical limits shall be the regulations governing the roadbed clearance for the specific utility involved.
- (3) The lower vertical limits shall be either the top of the utility at the depth below the proposed grade as prescribed by the governing agency or the limits of excavation, whichever is less.

(b) Limits of Proposed Construction for Utilities Crossing the Roadway in a Generally Transverse Direction.

- (1) Utilities crossing excavations for structures that are normally made by trenching such as sewers, underdrains, etc. and all minor structures such as manholes, inlets, foundations for signs, foundations for traffic signals, etc., the limits shall be the space to be occupied by the proposed permanent construction, unless otherwise required by the regulations governing the specific utility involved.
- (2) For utilities crossing the proposed site of major structures such as bridges, sign trusses, etc., the limits shall be as defined above for utilities extending in the same general direction as the roadway.

It is understood and agreed that the Contractor has considered in the bid all of the permanent and temporary utilities in their present and/or adjusted positions as indicated in the contract. It is further understood the actual location of the utilities may be located anywhere within the tolerances provided in 220 ILCS 50/2.8 or Administrative Code Title 92 Part 530.40(c), and the proximity of some utilities to construction may require extraordinary measures by the Contractor to protect those utilities.

No additional compensation will be allowed for any delays, inconveniences, or damages sustained by the Contractor due to the presence of or any claimed interference from known utility facilities or any adjustment of them, except as specifically provided in the contract.

107.38 Adjustments of Utilities within the Project Limits. The adjustment of utilities consists of the relocation, removal, replacement, rearrangements, reconstruction, improvement, disconnection, connection, shifting, new installation, or altering of an existing utility facility in any manner.

Utilities which are to be adjusted shall be adjusted by the utility owner or the owner's representative or by the Contractor as a contract item. Generally, arrangements for adjusting known utilities will be made by the Department prior to project construction; however, utilities will not necessarily be adjusted in advance of project construction and, in some cases, utilities will not be removed from the proposed construction limits as described in Article 107.37. When utility adjustments must be performed in conjunction with construction, the utility adjustment work will be indicated in the contract.

The Contractor may make arrangements for adjustment of utilities indicated in the contract, but not scheduled by the Department for adjustment, provided the Contractor furnishes the Department with a signed agreement with the utility owner covering the adjustments to be made. The cost of any such adjustments shall be the responsibility of the Contractor.

107.39 Contractor's Responsibility for Locating and Protecting Utility Property and Services. At points where the Contractor's operations are adjacent to properties or facilities of utility companies, or are adjacent to other property, damage to which might result in considerable expense, loss, or inconvenience, work shall not be commenced until all arrangements necessary for the protection thereof have been made.

Within the State of Illinois, a State-Wide One Call Notice System has been established for notifying utilities. Outside the city limits of the City of Chicago, the system is known as the Joint Utility Locating Information for Excavators (JULIE) System. Within the city limits of the City of Chicago the system is known as DIGGER. All utility companies and municipalities which have buried utility facilities in the State of Illinois are a part of this system.

The Contractor shall call JULIE (800-892-0123) or DIGGER (312-744-7000), a minimum of 48 hours in advance of work being done in the area, and they will notify all member utility companies involved their respective utility should be located.

For utilities which are not members of JULIE or DIGGER, the Contractor shall contact the owners directly. The plan general notes will indicate which utilities are not members of JULIE or DIGGER.

The following table indicates the color of markings required of the State-Wide One Call Notification System.

Utility Service	Color
Electric Power, Distribution and Transmission	Safety Red
Municipal Electric Systems	Safety Red
Gas Distribution and Transmission	High Visibility Safety Yellow
Oil Distribution and Transmission	High Visibility Safety Yellow
Telephone and Telegraph System	Safety Alert Orange
Community Antenna Television Systems	Safety Alert Orange

Water Systems	Safety Precaution Blue
Sewer Systems	Safety Green
Non-Potable Water and Slurry Lines	Safety Purple
Temporary Survey	Safety Pink
Proposed Excavation	Safety White (Black when snow is on the ground)

The State-Wide One Call Notification System will provide for horizontal locations of utilities. When it is determined that the vertical location of the utility is necessary to facilitate construction, the Engineer may make the request for location from the utility after receipt of notice from the Contractor. If the utility owner does not field locate their facilities to the satisfaction of the Engineer, the Engineer will authorize the Contractor in writing to proceed to locate the facilities in the most economical and reasonable manner, subject to the approval of the Engineer, and be paid according to Article 109.04.

The Contractor shall be responsible for maintaining the excavations or markers provided by the utility owners.

The Contractor shall take all necessary precautions for the protection of the utility facilities. The Contractor shall be responsible for any damage or destruction of utility facilities resulting from neglect, misconduct, or omission in the Contractor's manner or method of execution or non-execution of the work, or caused by defective work or the use of unsatisfactory materials. Whenever any damage or destruction of a utility facility occurs as a result of work performed by the Contractor, the utility company will be immediately notified. The utility company will make arrangements to restore such facility to a condition equal to that existing before any such damage or destruction was done.

In the event of interruption of utility services as a result of accidental breakage or as a result of being exposed or unsupported, the Contractor shall promptly notify the proper authority and shall cooperate with the said authority in the restoration of service. If water service is interrupted, repair work shall be continuous until the service is restored. No work shall be undertaken around fire hydrants until provisions for continued service have been approved by the local fire authority.

107.40 Conflicts with Utilities. Except as provided hereinafter, the discovery of a utility in an unanticipated location will be evaluated according to Article 104.03. It is understood and agreed that the Contractor has considered in the bid all facilities not meeting the definition of a utility in an unanticipated location and no additional compensation will be allowed for any delays, inconveniences, or damages sustained by the Contractor due to the presence of or any claimed interference from such facilities.

When the Contractor discovers a utility in an unanticipated location, the Contractor shall not interfere with said utility, shall take proper precautions to prevent damage or interruption of the utility, and shall promptly notify the Engineer of the nature and location of said utility.

(a) Definition. A utility in an unanticipated location is defined as an active or inactive utility, which is either:

- (1) Located underground and (a) not shown in any way in any location on the contract documents; (b) not identified in writing by the Department to the Contractor prior to the letting; or (c) not located relative to the location shown in the contract within the tolerances provided in 220 ILCS 50/2.8 or Administrative Code Title 92 Part 530.40(c); or
- (2) Located above ground or underground and not relocated as provided in the contract.

Service connections shall not be considered to be utilities in unanticipated locations.

(b) Compensation. Compensation will not be allowed for delays, inconveniences, or damages sustained by the Contractor from conflicts with facilities not meeting the above definition; or if a conflict with a utility in an unanticipated location does not cause a shutdown of the work applicable to the utility or a documentable reduction in the rate of progress exceeding the limits set herein. The provisions of Article 104.03 notwithstanding, compensation for delays caused by a utility in an unanticipated location will be paid according to the provisions of this Article governing minor and major delays or reduced rate of production which are defined as follows:

- (1) Minor Delay. A minor delay occurs when the Contractor's operation is completely stopped by a utility in an unanticipated location for more than two hours, but not to exceed three weeks.
- (2) Major Delay. A major delay occurs when the Contractor's operation is completely stopped by a utility in an unanticipated location for more than three weeks.
- (3) Reduced Rate of Production Delay. A reduced rate of production delay occurs when the contractor's rate of production decreases by more than 25 percent and lasts longer than seven days.

(c) Payment. Payment for Minor, Major and Reduced Rate of Production Delays will be made as follows.

- (1) Minor Delay. Labor idled which cannot be used on other work will be paid for according to Article 109.04(b)(1) and (2) for the time between start of the delay and the minimum remaining hours in the work shift required by the prevailing practice in the area.

Equipment idled which cannot be used on other work, and which is authorized to standby on the project site by the Engineer, will be paid for according to Article 109.04(b)(4).

- (2) Major Delay. Labor will be the same as for a minor delay.

Equipment will be the same as for a minor delay, except Contractor-owned equipment will be limited to three weeks plus the cost of move-out to either the Contractor's yard or another job, whichever is less.

Rental equipment may be paid for longer than three weeks provided the Contractor presents adequate support to the Department (including lease agreement) to show retaining equipment on the job is the most economical course to follow and in the public interest.

- (3) Reduced Rate of Production Delay. The Contractor will be compensated for the reduced productivity for labor and equipment time in excess of the 25 percent threshold for that portion of the delay in excess of seven days. Determination of compensation will be in accordance with Article 104.02, except labor and material additives will not be permitted.

Whether covered by (1), (2) or (3) above, additional traffic control required as a result of the operation(s) delayed will be paid for according to Article 109.04 for the total length of the delay.

If the delay is clearly shown to have caused work, which would have otherwise been completed, to be done after material or labor costs have increased, such increases may be paid. Payment for materials will be limited to increased cost substantiated by documentation furnished by the Contractor. Payment for increased labor rates will include those items in Article 109.04(b)(1) and (2), except the 35 percent and ten percent additives will not be permitted. On a working day contract, a delay occurring between November 30 and May 1, when work has not started, will not be considered as eligible for payment of measured labor and material costs.

Project overhead (not including interest) will be allowed when all progress on the contract has been delayed, and will be calculated as 15 percent of the delay claim.

- (d) Other Obligations of Contractor. Upon payment of a claim under this provision, the Contractor shall assign subrogation rights to the Department for the Department's efforts of recovery from any other party for monies paid by the Department as a result of any claim under this Provision. The Contractor shall fully cooperate with the Department in its efforts to recover from another party any money paid to the Contractor for delay damages under this Provision."

WORKING DAYS (BDE)

Effective: January 1, 2002

The Contractor shall complete the work within 30 working days.

STATE OF ILLINOIS

DEPARTMENT OF TRANSPORTATION

DIVISION OF HIGHWAYS

PROPOSED HIGHWAY PLANS

ROUTE VARIOUS SECTION VARIOUS

D2 GREENLIGHT 2012-2 VARIOUS COUNTY

C-92-066-12

10629

CONTRACT NO. 64H30

D2-902-12

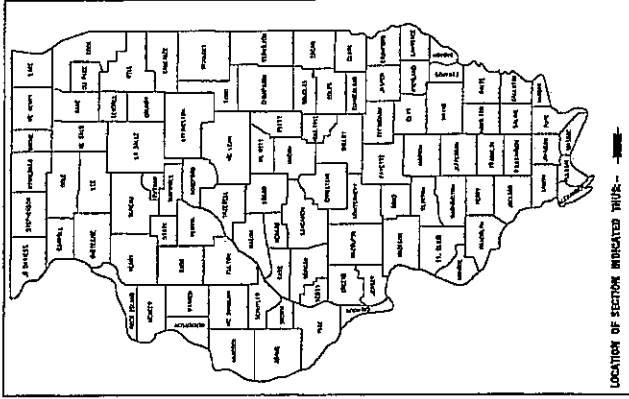

- INDEX OF SHEETS
1. COVER SHEET AND INDEX OF SHEETS
 2. SUMMARY OF QUANTITIES
 3. GENERAL NOTES
 4. LIST OF UPS AND SNOW SHIELD ONLY LOCATIONS
 5. IDOT LOCATIONS TABULATIONS
 6. IDOT PLAN SHEETS
 7. FREEPORT LOCATIONS TABULATIONS
 - 8 - 25. FREEPORT PLAN SHEETS
 26. MORRISON LOCATIONS TABULATIONS
 - 27-29 MORRISON PLANS SHEETS

- STANDARD
- 701101-02
 - 701106-02
 - 701406-06
 - 701421-04
 - 701701-08
 - 701901-02
 - 720001-01
 - 720006-02
 - 857001-01
 - 862001-01
 - 873001-02
 - 880006-01

SULLIVAN
 JOB UTILITY LOCATION INFORMATION FOR EXCAVATION
 1-800-432-0723
 OR 811

PROJECT ENGINEER SCOTT KULLERSTRAND 815-284-5468
 PROJECT MANAGER KRISTINE HILL 815-284-5476

CONTRACT NO. 64H30

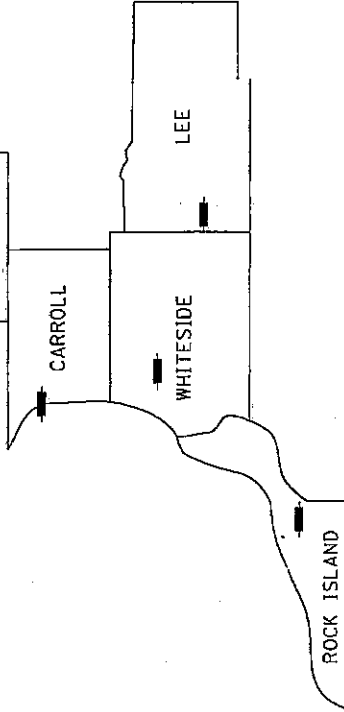

STATE OF ILLINOIS
 DEPARTMENT OF TRANSPORTATION
 DIVISION OF HIGHWAYS

SUBMITTED 12-8-20
Eric S. MacLellan
 DEPUTY DIRECTOR OF HIGHWAYS, REGION ENGINEER

20

ENGINEER OF DESIGN AND ENVIRONMENT

20

DIRECTOR OF HIGHWAYS, CHIEF ENGINEER

PRINTED BY THE AUTHORITY
 OF THE STATE OF ILLINOIS

SHEET 2 OF 29
 CONTRACT 64H30
 VARIOUS ROUTES
 VARIOUS COUNTIES

RURAL URBAN RURAL

	IDOT	FREEPORT		MORRISON		TOTAL
		100%/0%	95%/5%	95%/5%	STATE/LOCAL	
SUMMARY OF QUANTITIES						
		0021	0021	0021	0021	
67100100	MOBILIZATION	LSUM	0.19	0.69	0.12	1
70100310	TRAFFIC CONTROL AND PROTECTION, STANDARD 701421	LSUM	0.19	0.69	0.12	1
70102635	TRAFFIC CONTROL AND PROTECTION, STANDARD 701701	LSUM	0.19	0.69	0.12	1
85000300	MAINTENANCE OF EXISTING TRAFFIC SIGNALS	LSUM	0.19	0.69	0.12	1
86200200	UNINTERRUPTIBLE POWER SUPPLY, STANDARD	EACH	4	2	0	6
85700200	FULL-ACTUATED CONTROLLER AND TYPE IV CABINET	EACH	0	2	0	2
88040070	SIGNAL HEAD, POLYCARBONATE, LED, 1-FACE, 3-SECTION, BRACKET MOUNTED	EACH	0	0	9	9
88040090	SIGNAL HEAD, POLYCARBONATE, LED, 1-FACE, 3-SECTION, MAST ARM MOUNTED	EACH	0	3	1	4
88040120	SIGNAL HEAD, POLYCARBONATE, LED, 1-FACE, 4-SECTION, MAST ARM MOUNTED	EACH	0	1	1	2
88040150	SIGNAL HEAD, POLYCARBONATE, LED, 1-FACE, 5-SECTION, BRACKET MOUNTED	EACH	0	1	1	2
88040160	SIGNAL HEAD, POLYCARBONATE, LED, 1-FACE, 5-SECTION, MAST ARM MOUNTED	EACH	0	3	1	4
88102025	PEDESTRIAN SIGNAL HEAD, POLYCARBONATE, LED, 1-FACE, BRACKET MOUNTED, WITH COUNT DOWN TIMER	EACH	4	82	24	110
88200100	TRAFFIC SIGNAL BACK-PLATE	EACH	0	16	2	18
88500500	INDUCTION LOOP DETECTOR AMPLIFIER	EACH	0	16	0	16
88800100	PEDESTRIAN PUSH-BUTTON	EACH	4	82	24	110
89502100	REBUILD EXISTING SIGNAL HEAD	EACH	0	14	0	14
89502375	REMOVE EXISTING TRAFFIC SIGNAL EQUIPMENT	EACH	5	18	3	26
X8807670	SIGNAL HEAD, LED, RETROFIT	EACH	43	830	91	964
X8570100	DISCONNECT SWITCH	EACH	0	1	0	1
X8609005	LED SIGNAL FACE, LENS COVER	EACH	260	0	0	260

General Notes IDOT locations:

1. Uninterruptible Power Supply, Standard, pay item to be install shall include Modifications of the existing controller cabinet.
2. The item Signal Head, LED, Retrofit shall be paid for as each per indication. The complete signal head layouts are indicated on the plan sheets per intersection.
3. Traffic Signal Equipment to be removed are as listed on the plans sheets per each intersection and shall remain the property of the Department of Transportation.

General Notes Freeport:

1. Uninterruptible Power Supply, Standard, pay item to be install shall include Modifications of the existing controller cabinet.
2. Full-Actuated Controller and Type IV, Cabinet, pay item shall include all material and labor to place the cabinet on the existing foundation.
3. The item Signal Head, LED, Retrofit shall be paid for as each per indication. The complete signal head layouts are indicated on the plan sheets per intersection.
4. Rebuild the Existing Traffic Signal Head refers to any brackets on the bracket mounded signal head that are broken and the replacement and installation of signal head visors as indicated on the plans sheets.
5. Traffic Signal Equipment to be removed are as listed on the plans sheets per each intersection and shall remain the property of the Freeport.

General Notes Morrison:

1. The item Signal Head, LED, Retrofit shall be paid for as each per indication. The complete signal head layouts are indicated on the plan sheets per intersection.
2. Traffic Signal Equipment to be removed are as listed on the plans sheets per each intersection and shall remain the property of the Morrison.
3. Any brackets, hardware and labor shall be included in the cost for the replacement of signal at US 30 at Genesee.

SHEET 4 OF 29
 CONTRACT 64H30
 SEC 02 GREENLIGHT 2012-2
 VARIOUS ROUTES
 VARIOUS COUNTIES

**UNINTERRUPTIBLE POWER SUPPLY, STANDARD
 AND SNOW SHIELD LENS
 INSTALLATION ONLY AT THE FOLLOWING INTERSECTIONS;**

- IL 2 AT SAUK ROAD, LEE CO
- AVE OF THE CITIES AT IL 5, ROCK ISLAND CO
- AVE OF THE CITIES AT IL 84, ROCK ISLAND CO
- IL 5 AT BARSTOW RD, ROCK ISLAND CO

IDOT	UPS	Snow Shields
IL 2 at Sauk Road	1	53
IL 5 at Colona Rd	1	76
IL 84 at Colona Rd	1	28
IL 5 at Barstow Rd	1	41

PROJECT NO. 03-00-00-00-00-00 SHEET NO. 04 OF 29 SHEETS ID STA. _____ TO STA. _____	STATE OF ILLINOIS DEPARTMENT OF TRANSPORTATION	UPS AND SNOW SHIELD LENS LOCATIONS IDOT ONLY	SECTION _____ COUNTY _____ CONTRACT NO. _____ ALIQUOT/ID. NO. _____
DESIGNED BY _____ DRAWN BY _____ CHECKED BY _____ DATE _____	REVISIONS: 1. _____ 2. _____ 3. _____	SCALE: _____	SHEET NO. 04 OF 29 SHEETS

SHEET 5 OF 29
Contract 64H30
VARIOUS ROUTES
VARIOUS COUNTIES

IDOT	Location	UPS	Snow Shields	Retro-fit Existing Signals with LED						Ped Heads	Ped Buttons	
				5 - Section MAM	5 - Section BM	4 - Section MAM	3 - Section MAM	3 - Section BM	3 - Section MAM			
	IL 2 at Sauk Road	1	53									
	IL 5 at Colona Rd	1	76									
	IL 84 at Colona Rd	1	28									
	IL 5 at Barstow Rd	1	41									
	US 52 & IL 64 at IL 84	1	62	2	2	2	3	2	4			4

SHEET OF 6 OF 29
 CONTRACT 64H30
 SEC D2 GREENLIGHT 2012-2
 VARIOUS ROUTES
 VARIOUS COUNTIES

PHASE DESIGNATION DIAGRAM

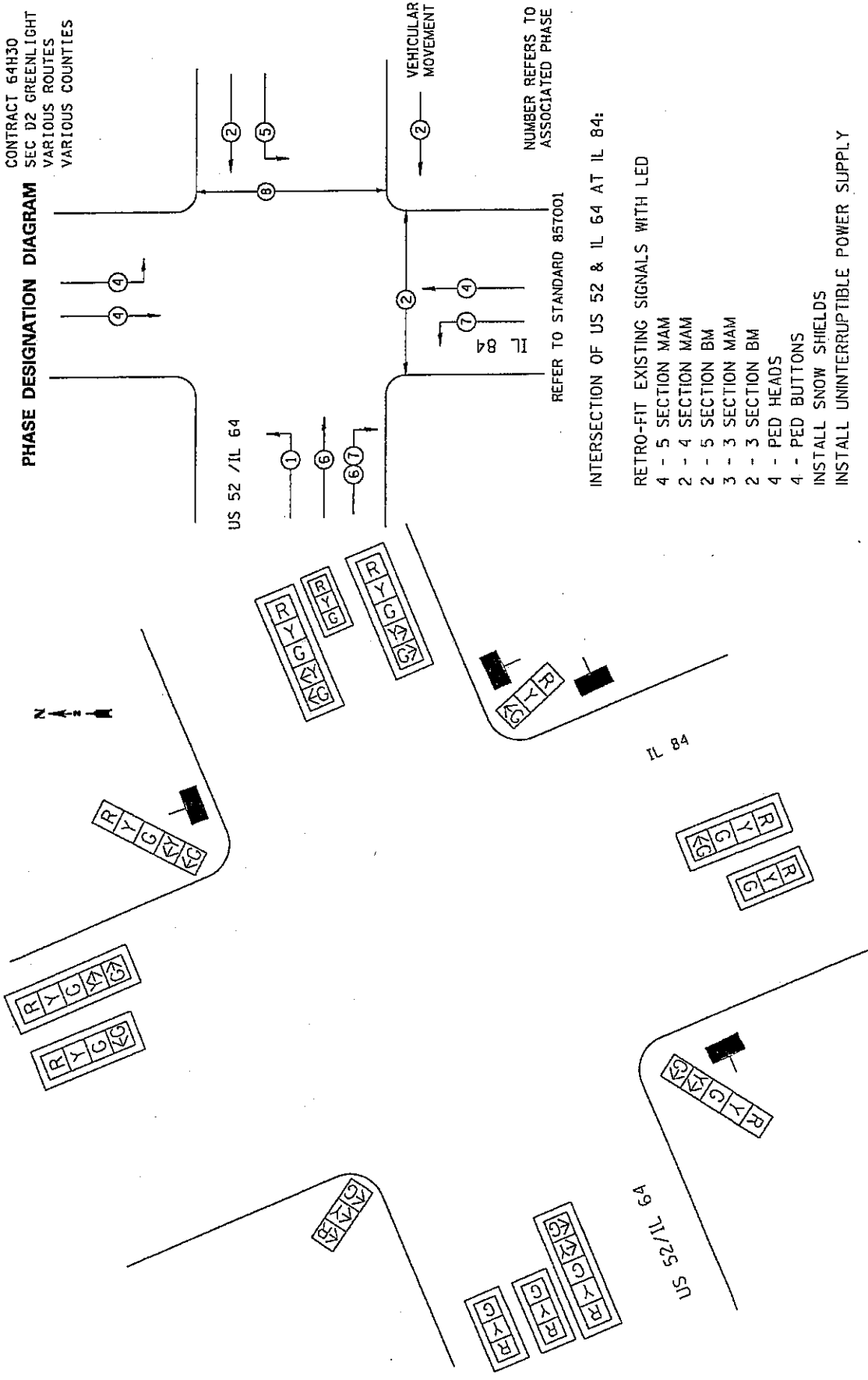

NUMBER REFERS TO ASSOCIATED PHASE

REFER TO STANDARD 85T001

INTERSECTION OF US 52 & IL 64 AT IL 84:

RETRO-FIT EXISTING SIGNALS WITH LED

- 4 - 5 SECTION MAM
- 2 - 4 SECTION MAM
- 2 - 5 SECTION BM
- 3 - 3 SECTION MAM
- 2 - 3 SECTION BM
- 4 - PED HEADS
- 4 - PED BUTTONS

INSTALL SNOW SHIELDS
 INSTALL UNINTERRUPTIBLE POWER SUPPLY

FILE NAME: _____ APPROVED: _____ DATE: _____		DESIGNED: _____ DRAWN: _____ CHECKED: _____ DATE: _____		REVISIONS: REVISION: _____ REVISION: _____ REVISION: _____	
PROJECT NO.: 102277 / A DATE: 1/10/08		SHEET NO. OF SHEETS: 57A TO STA. _____		COUNTY: _____ SECTION: _____ CONTRACT NO.: _____ ILLUSTRATED BY: _____	
STATE OF ILLINOIS DEPARTMENT OF TRANSPORTATION					
US 52/IL 64 AND IL 84 IDOT (JANABKA)					

SHEET 7 OF 29
 Contract 64H30
 VARIOUS ROUTES
 VARIOUS COUNTIES

Location	Retro fit				R/R SIGNAL HEAD				Ped Head	Ped Buttons	Cabinet	UPS	Brackets *	Visors *	BACKPLATE	Disconnect	Detector Amplifier
	3-Sec MAM	3-Sec BM	4-Sec MAM	5-Sec MAM	3-Sec MAM	5-Sec MAM	3-Sec BM	5-Sec MAM									
Freeport																	
US BR 20 at Park Blvd	7			4					4	4							
US BR 20 at Hunt Crestwood	8			2					4	4							
US BR 20 at Turner Ave	8			2					4	4							
US BR 20 at Harlem Ave	7			3					8	8							
US BR 20 at IL 26	8	1		4					8	8		1	2				
IL 26 at Stephenson St	4			4					8	8	1						
IL 26 at Lincoln Blvd	8								8	8							
IL 26 at Empire St	1								8	8	1	1				1	8
IL 26 at Youngs Lane	6			4									2	2			
IL 26 at South St	10	5		2									1	1			
IL 26 at Meadow Dr	8	2		2									2				
IL 26 at K-mart	8	2		2									1		10		
IL 75 at Stephenson St	6	3							8	8							8
IL 75 at Main St	6	3							8	8				2	6		
IL 75 at Commercial Ave	6								2	2							
South St at Locust	6			4					4	4			1				
South St at Aldi/Osco	7	4		1													
South St at Walnut Ave	8			4					8	8							
TOTAL	366	60	4	190	210	3	3	1	82	82	2	2	9	5	16	1	16

SHEET B OF 29
 CONTRACT 64H30
 SEC D2 GREENLIGHT 2012-2
 VARIOUS ROUTES
 VARIOUS COUNTIES

PHASE DESIGNATION DIAGRAM

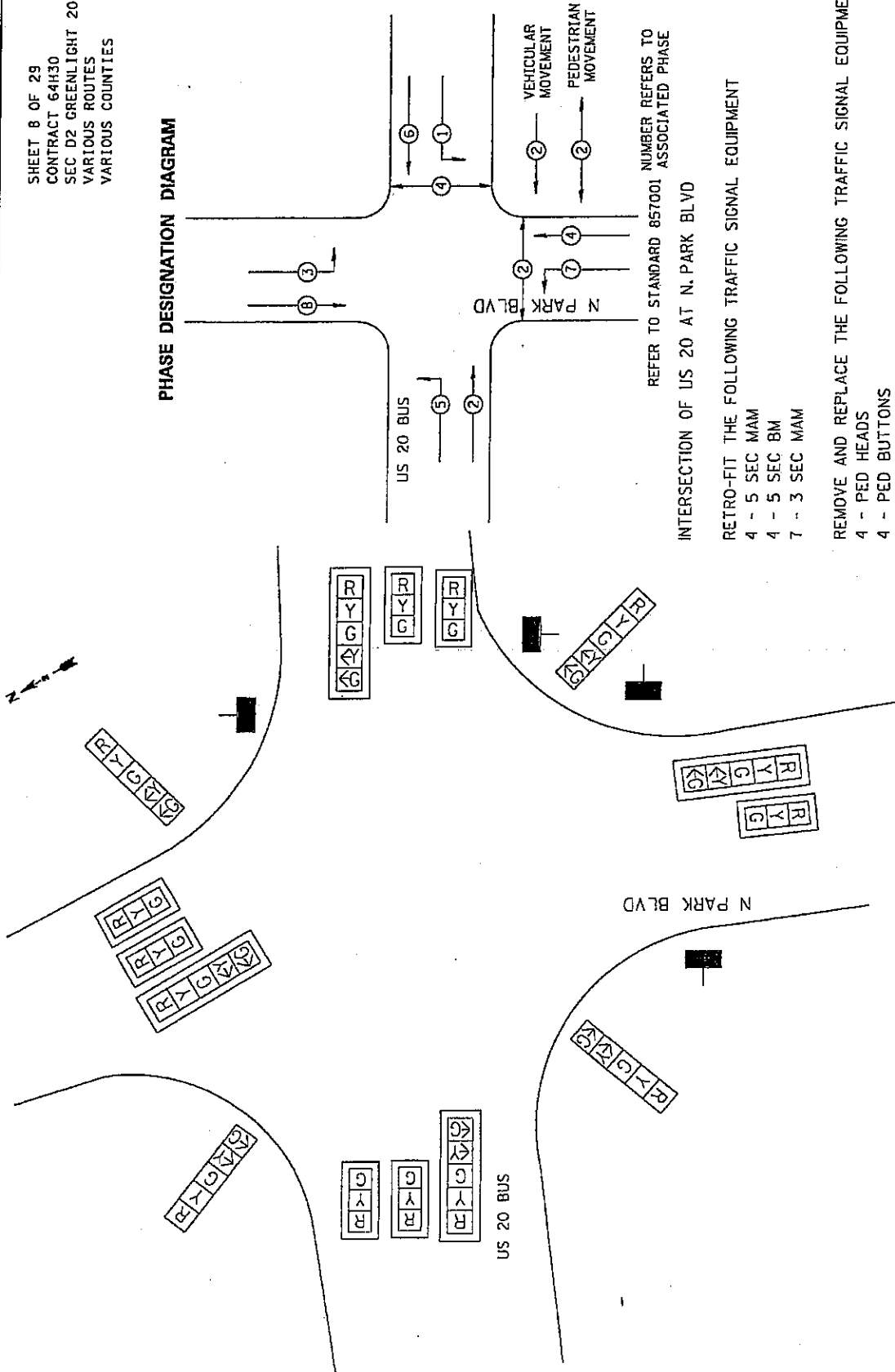

REFER TO STANDARD 857001 NUMBER REFERS TO ASSOCIATED PHASE

INTERSECTION OF US 20 AT N. PARK BLVD

RETRO-FIT THE FOLLOWING TRAFFIC SIGNAL EQUIPMENT

- 4 - 5 SEC MAM
- 4 - 5 SEC BM
- 7 - 3 SEC MAM

REMOVE AND REPLACE THE FOLLOWING TRAFFIC SIGNAL EQUIPMENT

- 4 - PED HEADS
- 4 - PED BUTTONS

DESIGNED	DATE	BY	REVISION	DATE	BY
CHECKED	DATE	BY	REVISION	DATE	BY
DATE	DATE	DATE	DATE	DATE	DATE
STATE OF ILLINOIS DEPARTMENT OF TRANSPORTATION			US 20 AT N. PARK BLVD PREPARED		
SCALE: SHEET NO. OF SHEETS 1 STA. TO STA.			COUNTY CONTRACT NO.		

SHEET 11 OF 29
 CONTRACT 64H30
 SEC D2 GREENLIGHT 2012-2
 VARIOUS ROUTES
 VARIOUS COUNTIES

PHASE DESIGNATION DIAGRAM

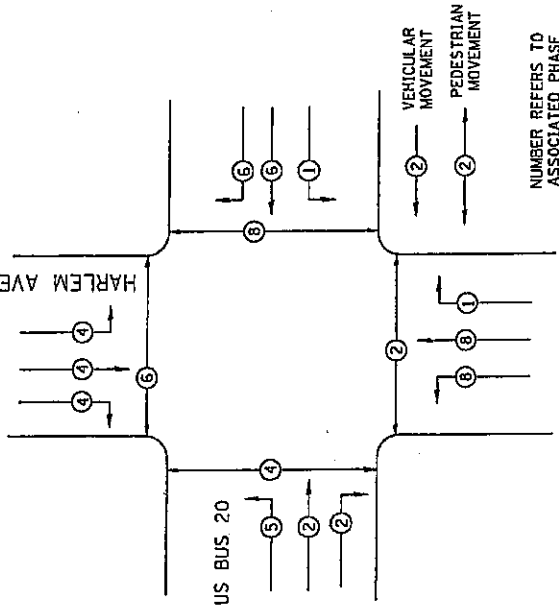

REFER TO STANDARD 857001

INTERSECTION OF US BUS 20 AT HARLEM AVE
 RETRO-FIT THE FOLLOWING SIGNAL HEADS
 3 - 5 SECTION MAM
 3 - 5 SECTION BM
 7 - 3 SECTION MAM

REMOVE AND REPLACE EXISTING TRAFFIC SIGNAL EQUIPMENT
 8 - PED BUTTON
 8 - PED HEAD

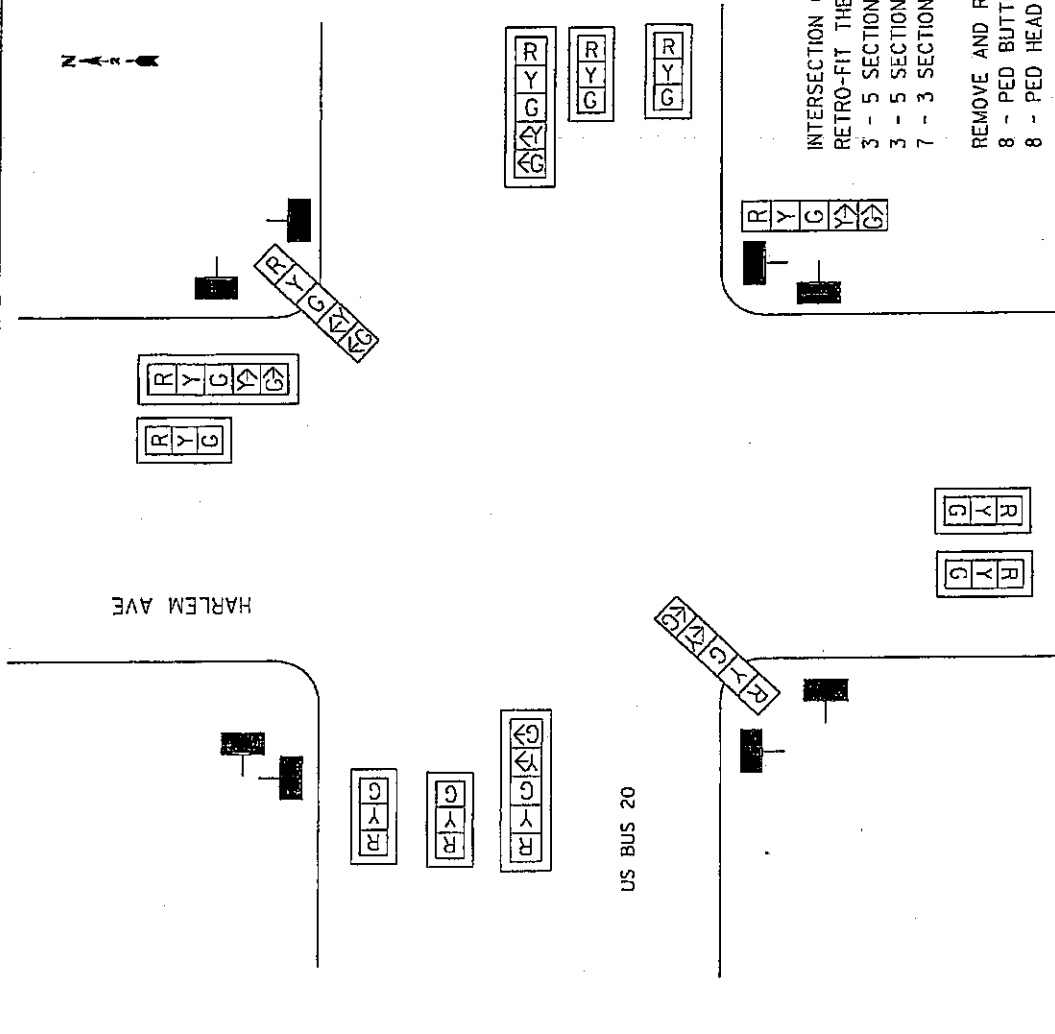

DESIGNED	CHECKED	DATE	DESIGNED	CHECKED	DATE
DRAWN	REVISION		REVISION		
PROJECT ENGINEER / IN CHARGE	PROJECT NO.	SHEET NO.	OF	SHEETS	TO STA.
DATE					
STATE OF ILLINOIS DEPARTMENT OF TRANSPORTATION			BUS 20 AT HARLEM FREEPORT		
SEE NAME - POINTS			COUNTY		
NOT SCALE - DIMENSIONS / IN.			SECTION		
NOT DATE - DIMENSIONS / IN.			SHEET NO.		
			NUMBER OF SHEETS		
			CONTRACT NO.		

SHEET 13 OF 29
 CONTRACT 64H30
 SEC D2 GREENLIGHT 2012-2
 VARIOUS ROUTES
 VARIOUS COUNTIES

PHASE DESIGNATION DIAGRAM

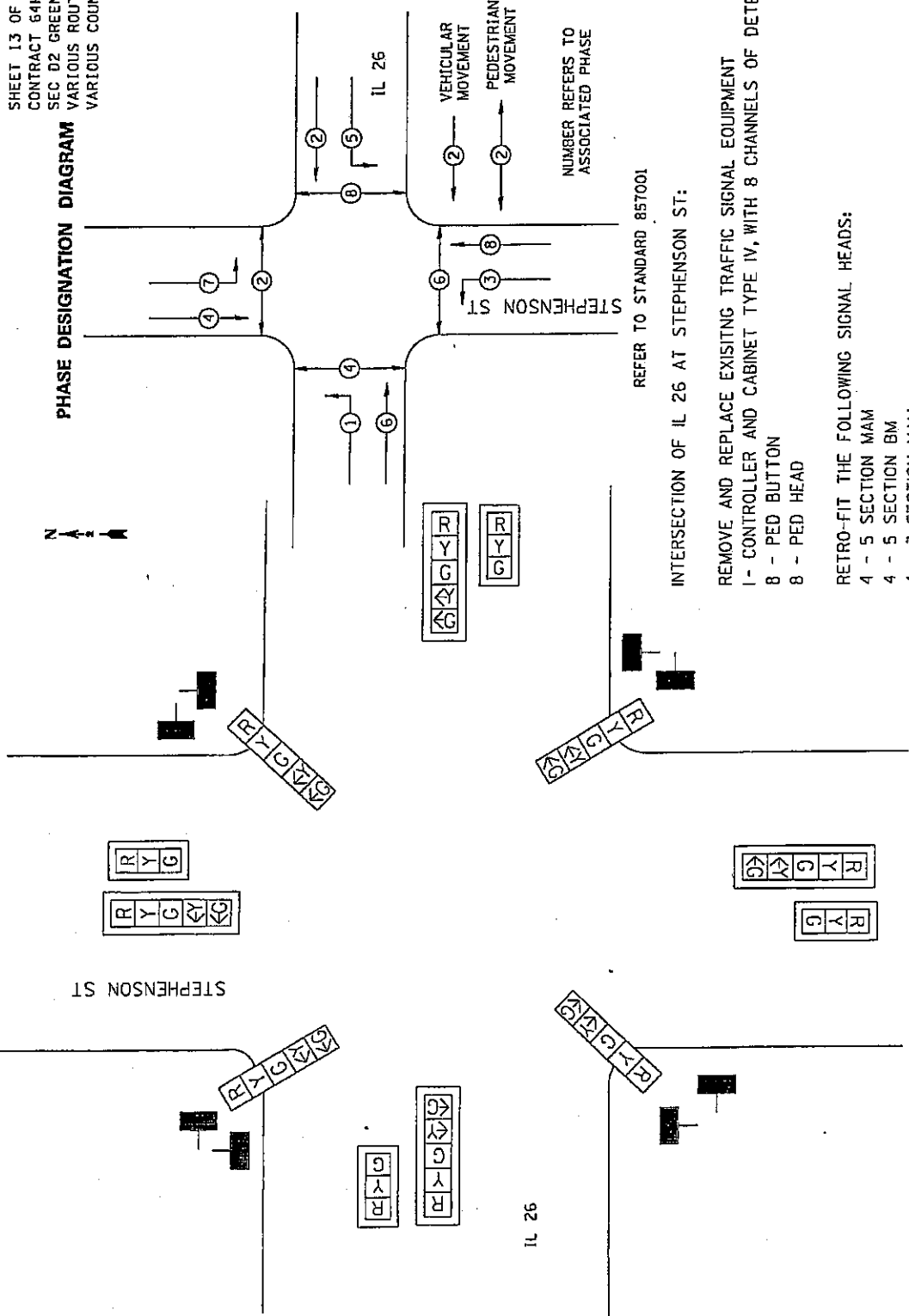

REFER TO STANDARD 85T001

INTERSECTION OF IL 26 AT STEPHENSON ST:

- REMOVE AND REPLACE EXISTING TRAFFIC SIGNAL EQUIPMENT
- 1 - CONTROLLER AND CABINET TYPE IV, WITH 8 CHANNELS OF DETECTION
- 8 - PED BUTTON
- 8 - PED HEAD

RETRO-FIT THE FOLLOWING SIGNAL HEADS:

- 4 - 5 SECTION MAM
- 4 - 5 SECTION BM
- 4 - 3 SECTION MAM

DATE: 11/15/11	DESIGNED BY: []	CHECKED BY: []	APPROVED BY: []	SCALE: []	SHEET NO. OF [] SHEETS [] TOTAL TO STA. []	SECTION: []	COUNTY: []	CONTRACT NO.: []	PROJECT: []
STATE OF ILLINOIS DEPARTMENT OF TRANSPORTATION				IL 26 AT STEPHENSON ST PREPARED					

SHEET 14 OF 29
 CONTRACT 64H30
 SEC 02 GREENLIGHT 2012-2
 VARIOUS ROUTES
 VARIOUS COUNTIES

PHASE DESIGNATION DIAGRAM

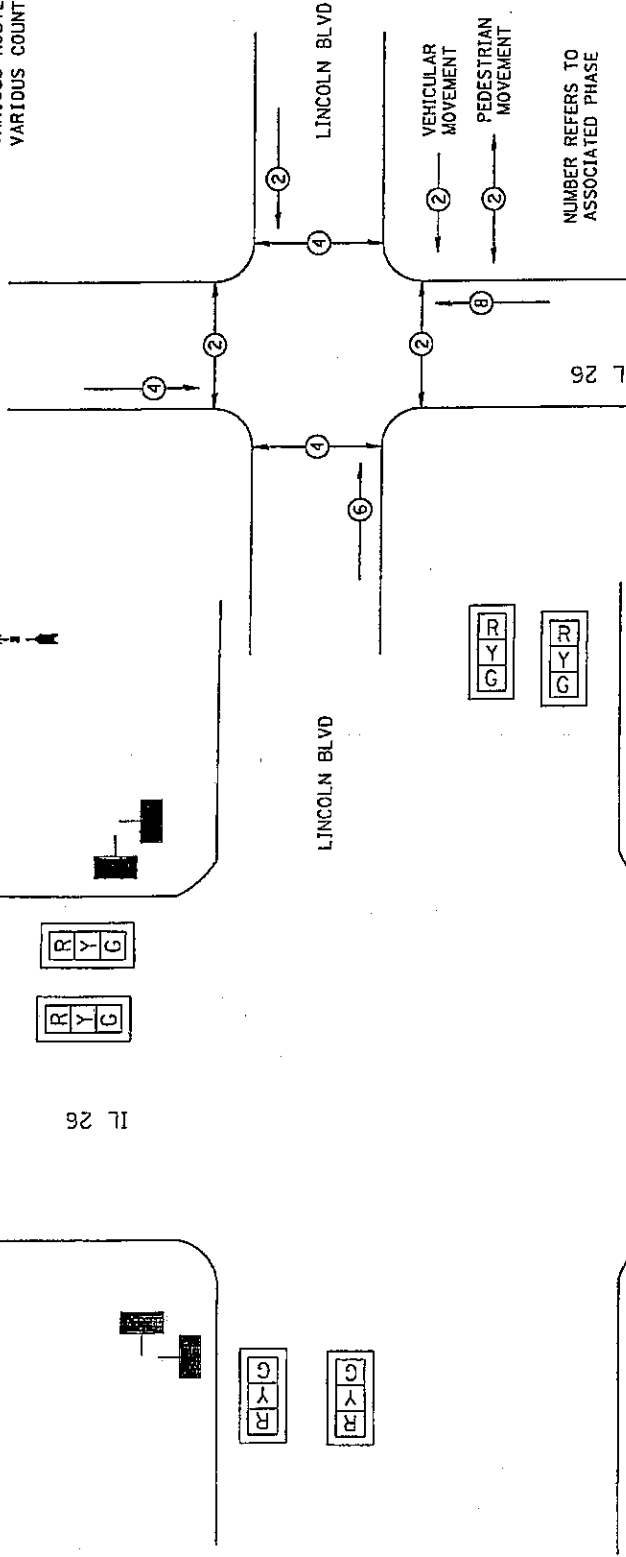

REFER TO STANDARD 857001

INTERSECTION OF IL 26 AT LINCOLN BLVD:

REMOVE AND REPLACE EXISTING TRAFFIC SIGNAL EQUIPMENT
 8 - PED BUTTON
 8 - PED HEAD

RETRO-FIT THE FOLLOWING SIGNAL HEADS:
 8 - 3 SECTION MAM

FILE NAME	DESIGNED	REVISION	SECTION	COUNTY	SHEET
PROJECT NUMBER	DATE	BY			
DATE	DATE	DATE			
STATE OF ILLINOIS DEPARTMENT OF TRANSPORTATION			IL 26 AT LINCOLN BLVD FREEPORT		
			SHEET NO. - OF - SHEETS TOTAL		
			TO SFL		
			CONTRACT NO.		
			REVISIONS TO SHEET		

SHEET 15 OF 29
 CONTRACT 64H30
 SEC D2 GREENLIGHT 2012-2
 VARIOUS ROUTES
 VARIOUS COUNTIES

PHASE DESIGNATION DIAGRAM

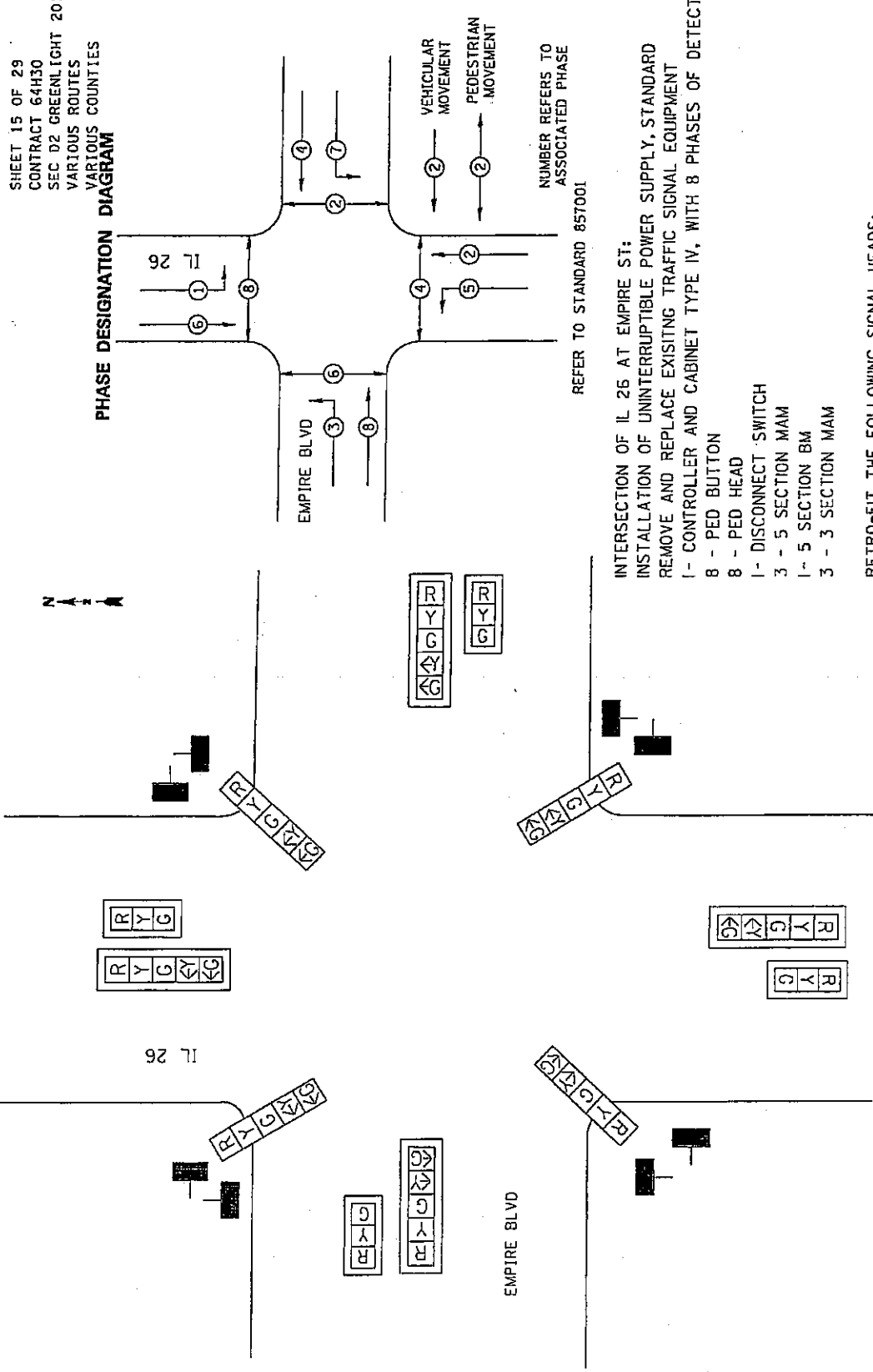

NUMBER REFERS TO ASSOCIATED PHASE
 REFER TO STANDARD 857001

- INTERSECTION OF IL 26 AT EMPIRE ST:
 INSTALLATION OF UNINTERRUPTIBLE POWER SUPPLY, STANDARD
 REMOVE AND REPLACE EXISTING TRAFFIC SIGNAL EQUIPMENT
 1 - CONTROLLER AND CABINET TYPE IV, WITH 8 PHASES OF DETECTION
 8 - PED BUTTON
 8 - PED HEAD
 1 - DISCONNECT SWITCH
 3 - 5 SECTION MAM
 1 - 5 SECTION BM
 3 - 3 SECTION MAM

RETRO-FIT THE FOLLOWING SIGNAL HEADS:
 1 - 3 SECTION MAM
 3 - 5 SECTION BM

FILE NO.	DESIGNED	REVISION	SCALE	SHEET NO. OF	SHEETS	TO STA.	REVISION	DATE	CONTRACT NO.	SECTION	COUNTY	SHEET NO.	TOTAL SHEETS
				15	29								

STATE OF ILLINOIS
 DEPARTMENT OF TRANSPORTATION

IL 26 AT EMPIRE BLVD
 PREPRINT

SHEET 17 OF 29
 CONTRACT 64H30
 SEC D2 GREENLIGHT 2012-2
 VARIOUS ROUTES
 VARIOUS COUNTIES

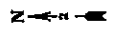

PHASE DESIGNATION DIAGRAM

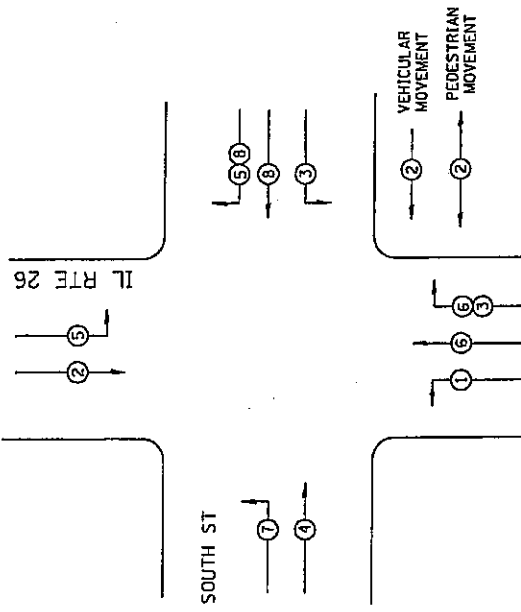

NUMBER REFERS TO ASSOCIATED PHASE

REFER TO STANDARD 857001

INTERSECTION OF IL 26 AT SOUTH ST:

INSTALLATION OF UNINTERRUPTIBLE POWER SUPPLY, STANDARD

RETRO-FIT THE FOLLOWING SIGNAL HEADS:

- 2 - 5 SECTION MAM
- 2 - 5 SECTION BM
- 10 - 3 SECTION MAM
- 5 - 3 SECTION BM

REBUILD EXISTING TRAFFIC SIGNAL EQUIPMENT

- 1 - VISOR
- 1 - BRACKET

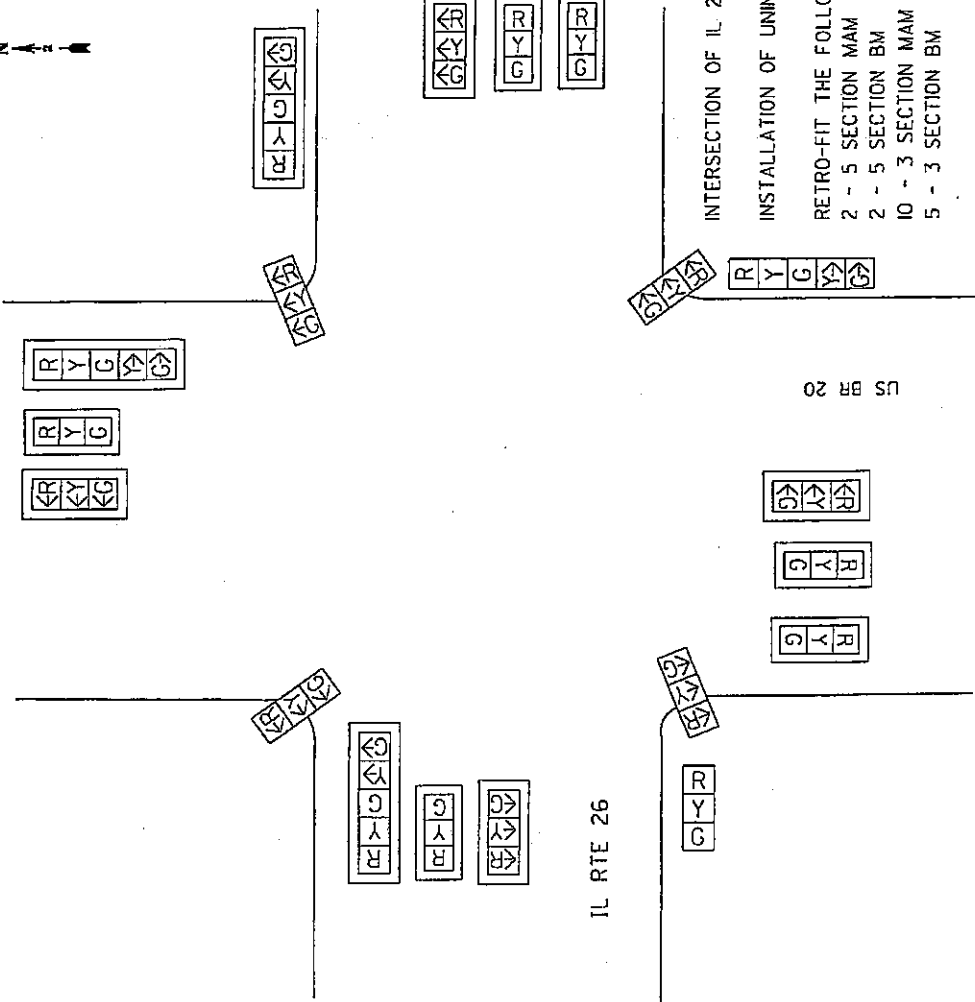

FILE NAME	DESIGNED	REVISION	SECTION	TOTAL SHEET
PROJECT NO.	DRAWN	REVISED	DATE	SHEETS
DATE	CHECKED	REVISED	NO.	OF
BY	DATE	DATE	NO.	NO.
STATE OF ILLINOIS		US BR 20 AT SOUTH ST		
DEPARTMENT OF TRANSPORTATION		FREEPORT		
		SHEET NO. OF SHEETS		TO STA.
		SHEET NO. OF SHEETS		TO STA.

SHEET 18 OF 29
 CONTRACT 64H30
 SEC D2 GREENLIGHT 2012-2
 VARIOUS ROUTES
 VARIOUS COUNTIES

PHASE DESIGNATION DIAGRAM

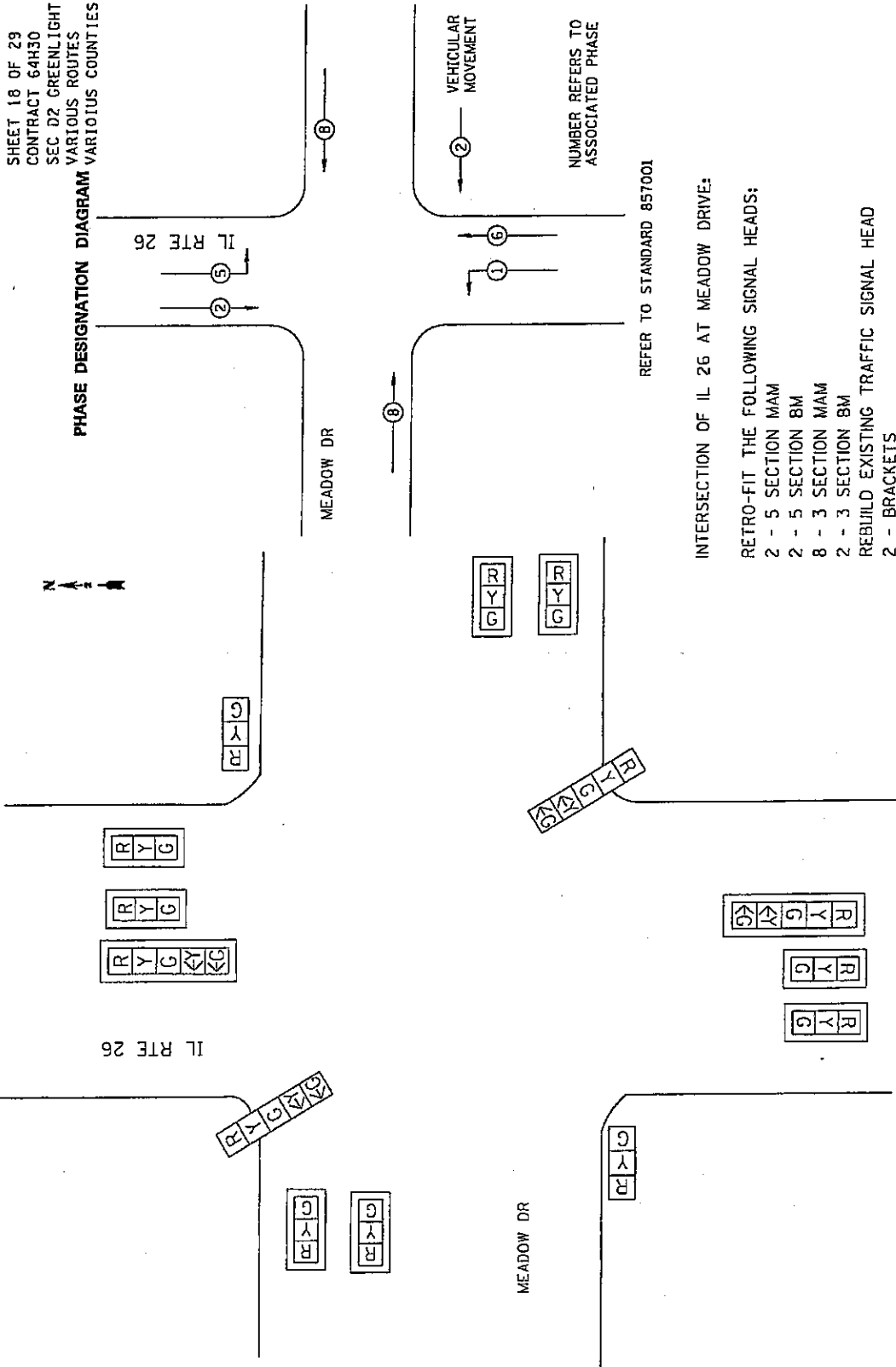

INTERSECTION OF IL 26 AT MEADOW DRIVE:

- RETRO-FIT THE FOLLOWING SIGNAL HEADS:
- 2 - 5 SECTION MAM
 - 2 - 5 SECTION BM
 - 8 - 3 SECTION MAM
 - 2 - 3 SECTION BM
 - REBUILD EXISTING TRAFFIC SIGNAL HEAD
 - 2 - BRACKETS

STATE OF ILLINOIS DEPARTMENT OF TRANSPORTATION		SHEET NO. 18 OF 29		CONTRACT NO. 64H30	
DESIGNED BY	DATE	REVISION	DATE	SECTION	PROJECT SHEET NO.
DRAWN BY	DATE	REVISION	DATE	SECTION	PROJECT SHEET NO.
CHECKED BY	DATE	REVISION	DATE	SECTION	PROJECT SHEET NO.
APPROVED BY	DATE	REVISION	DATE	SECTION	PROJECT SHEET NO.

SHEET 19 OF 29
 CONTRACT 64H30
 SEC D2 GREENLIGHT 2012-2
 VARIOUS ROUTES
 VARIOUS COUNTIES

PHASE DESIGNATION DIAGRAM

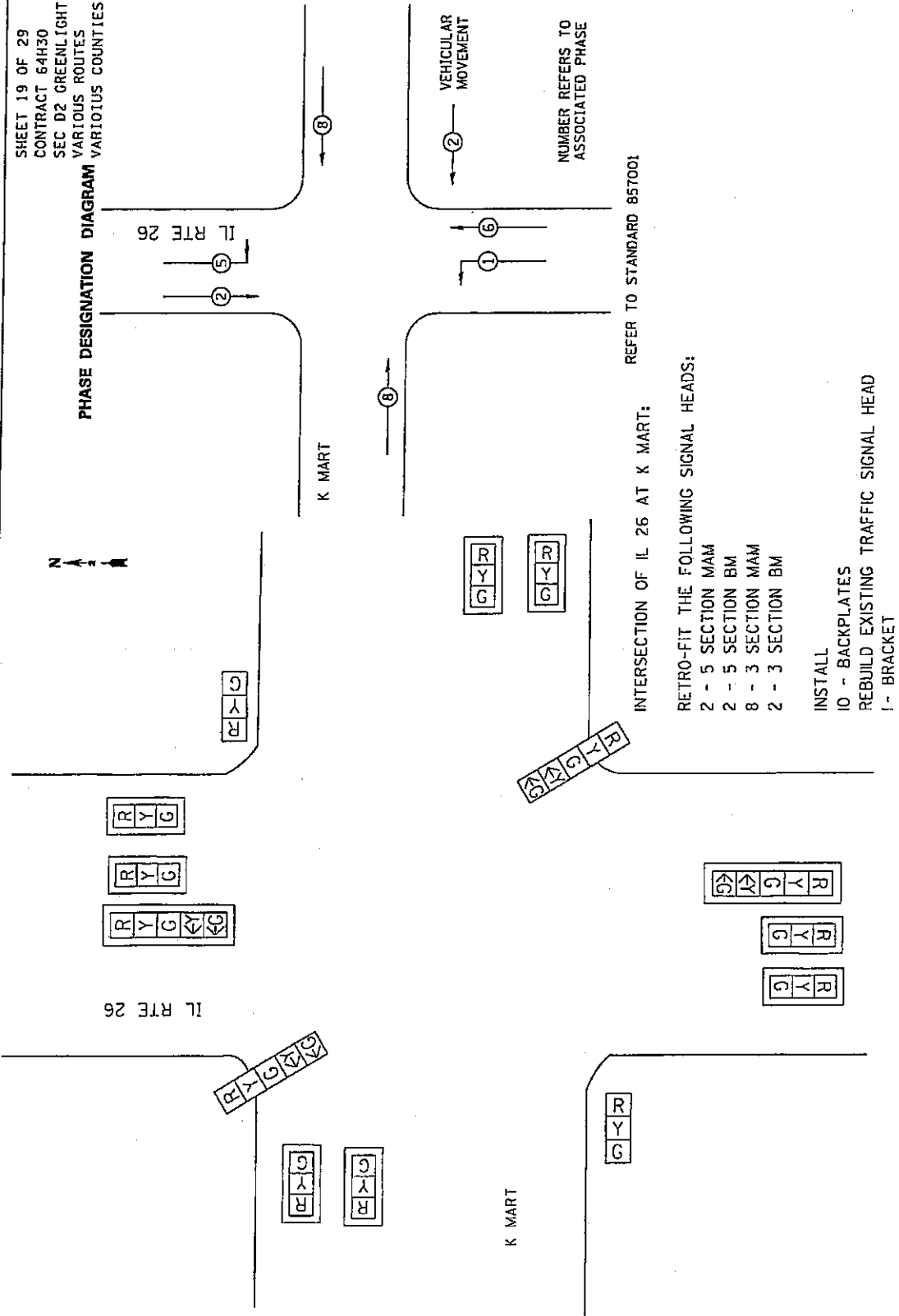

REFER TO STANDARD 857001

INTERSECTION OF IL 26 AT K MART:

RETRO-FIT THE FOLLOWING SIGNAL HEADS:

- 2 - 5 SECTION MAM
- 2 - 5 SECTION BM
- 8 - 3 SECTION MAM
- 2 - 3 SECTION BM

INSTALL

10 - BACKPLATES

REBUILD EXISTING TRAFFIC SIGNAL HEAD

1 - BRACKET

STATE OF ILLINOIS DEPARTMENT OF TRANSPORTATION	PROJECT NO. 29	SHEETS 19 OF 29	SECTION	COUNTY	CONTRACT NO.
DESIGNED BY	CHECKED BY	DATE	SECTION	COUNTY	CONTRACT NO.
REVISION	REVISION	REVISION	SECTION	COUNTY	CONTRACT NO.
DATE MADE & REVISION	DATE MADE & REVISION	DATE	SECTION	COUNTY	CONTRACT NO.
DATE MADE & REVISION	DATE MADE & REVISION	DATE	SECTION	COUNTY	CONTRACT NO.

SHEET 20 OF 29
 CONTRACT 64H30
 SEC D2 GREENLIGHT 2012-2
 VARIOUS ROUTES
 VARIOUS COUNTIES

PHASE DESIGNATION DIAGRAM

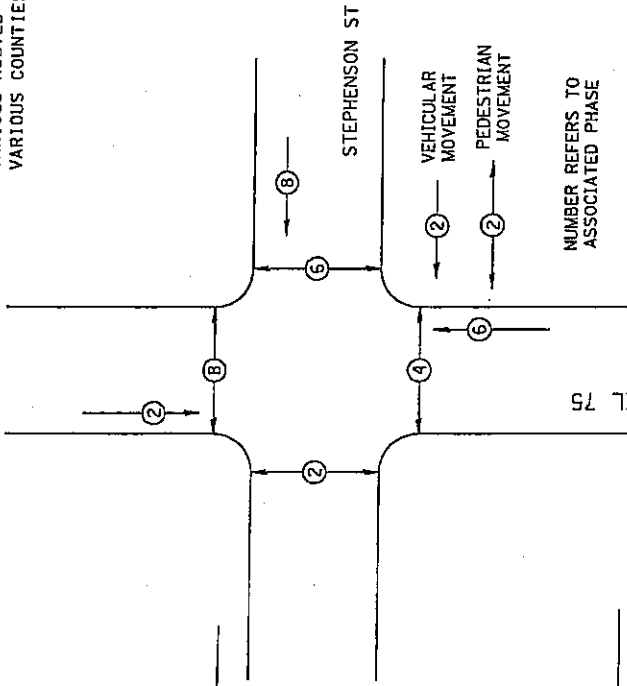

NUMBER REFERS TO ASSOCIATED PHASE

REFER TO STANDARD 857001

INTERSECTION OF IL 75 AT STEPHENSON ST:

- REMOVE AND REPLACE EXISTING TRAFFIC SIGNAL EQUIPMENT
- 8 - PED BUTTON
- 8 - PED HEAD

- RETRO-FIT THE FOLLOWING SIGNAL HEADS:
- 6 - 3 SECTION MAM
- 3 - 3 SECTION BM

STATE OF ILLINOIS
DEPARTMENT OF TRANSPORTATION

IL 75 AT STEPHENSON ST
PROJECT

SHEET NO. OF PROJECT
SHEET 20 OF 29

DATE	BY	REVISION

SHEET 22 OF 29
 CONTRACT 64H30
 SEC D2 GREENLIGHT 2012-2
 VARIOUS ROUTES
 VARIOUS COUNTIES

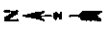

COMMERCIAL AVE

PHASE DESIGNATION DIAGRAM

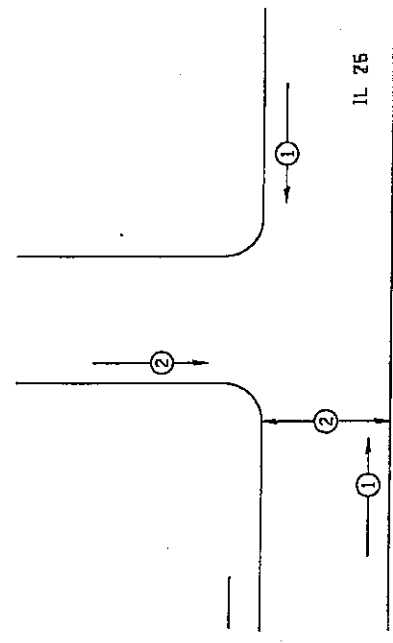

REFER TO STANDARD 857001

VEHICULAR MOVEMENT
 PEDESTRIAN MOVEMENT

NUMBER REFERS TO ASSOCIATED PHASE

INTERSECTION OF IL 75 COMMERCIAL AVE:

- REMOVE AND REPLACE EXISTING TRAFFIC SIGNAL EQUIPMENT
- 2 - PED BUTTON
- 2 - PED HEAD

RETRO-FIT THE FOLLOWING SIGNAL HEADS:
 6 - 3 SECTION MAM

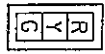
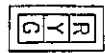
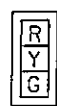
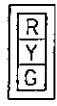

DESIGNED - DRAWN - CHECKED - DATE -	REVISIONS REVISED - REVISIONS - REVISED -	STATE OF ILLINOIS DEPARTMENT OF TRANSPORTATION		IL 75 AT COMMERCIAL AVE FREEDPORT		COUNTY - SECTION - SHEET NO. - OF - SHEETS - STA. - TO STA. -	TOTAL SHEET NO. CONTRACT NO.
		PROJECT NO. - DATE -		SHEET NO. - OF - SHEETS - STA. - TO STA. -		CONTRACT NO.	

SHEET 23 OF 29
 CONTRACT 64H30
 SEC D2 GREENLIGHT 2012-2
 VARIOUS ROUTES
 VARIOUS COUNTIES

PHASE DESIGNATION DIAGRAM

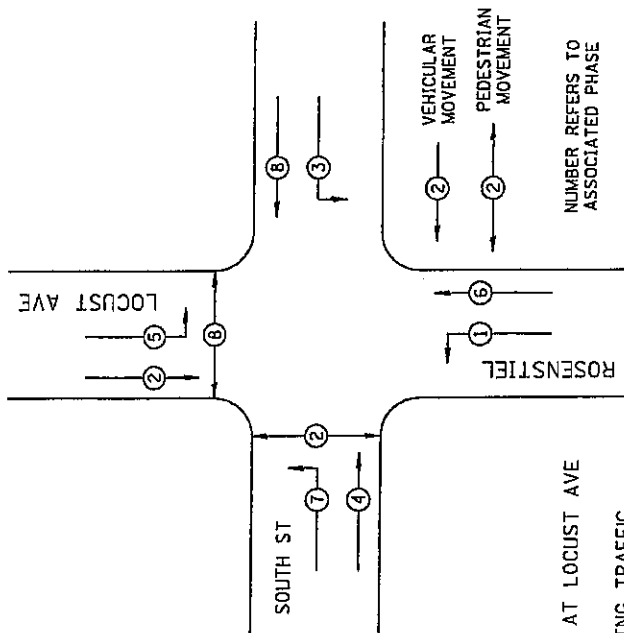

REFER TO STANDARD 657001

INTERSECTION OF SOUTH ST AT LOCUST AVE

- REMOVE AND REPLACE EXISTING TRAFFIC SIGNAL EQUIPMENT
- 8 - PED BUTTON
- 8 - PED HEAD

RETRO-FIT THE FOLLOWING SIGNAL HEADS:

- 4 - 5 SECTION MAM
- 4 - 5 SECTION BM
- 6 - 3 SECTION MAM

REBUILD EXISTING TRAFFIC SIGNAL HEAD

- 1 - BRACKET

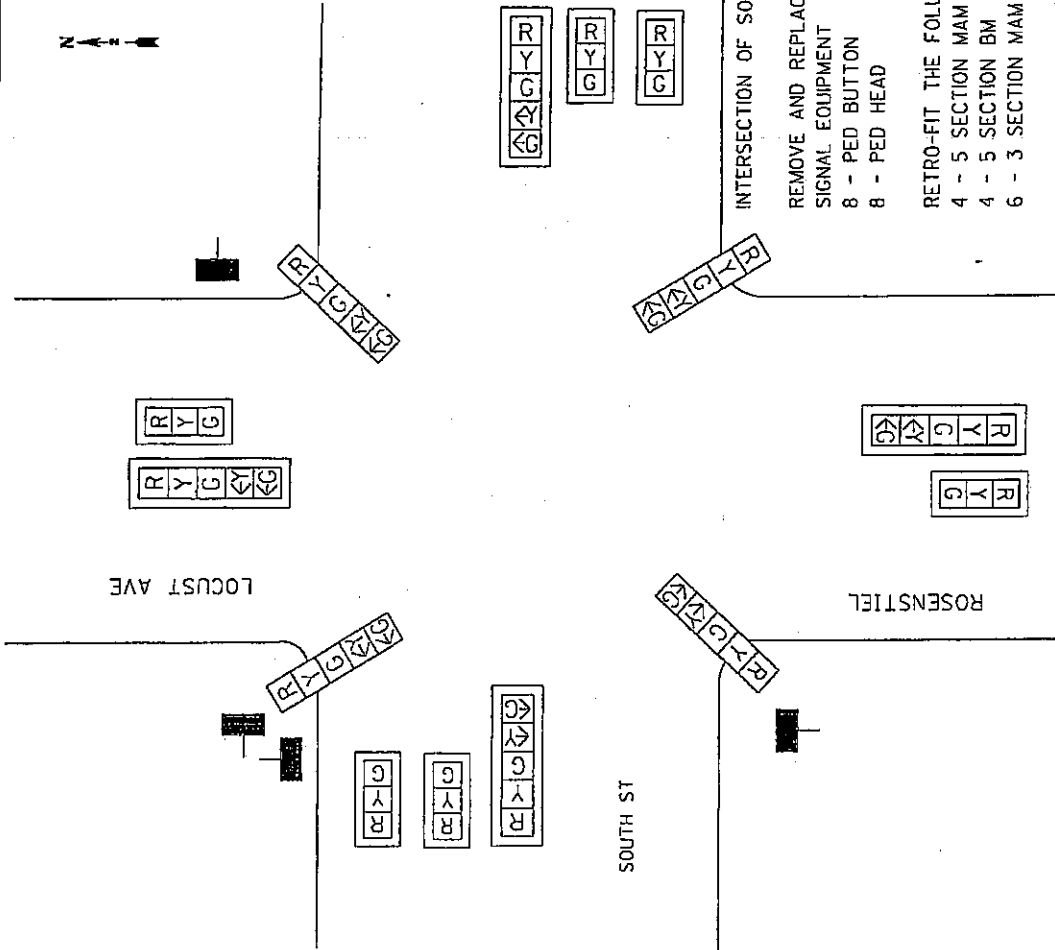

DESIGNED BY	DATE	REVISION	DATE	BY
CHECKED BY	DATE	REVISION	DATE	BY
PROJECT NO.	DATE	REVISION	DATE	BY
PROJECT NAME	DATE	REVISION	DATE	BY
SCALE	DATE	REVISION	DATE	BY
SHEET NO. 23 OF 29 SHEETS		TO STA.		
SOUTH ST AT LOCUST AVE FREEPORT		COUNTY		
STATE OF ILLINOIS DEPARTMENT OF TRANSPORTATION		CONTRACT NO.		

SHEET 24 OF 29
 CONTRACT 64H30
 SEC D2 GREENLIGHT 2012-2
 VARIOUS ROUTES
 VARIOUS COUNTIES

PHASE DESIGNATION DIAGRAM

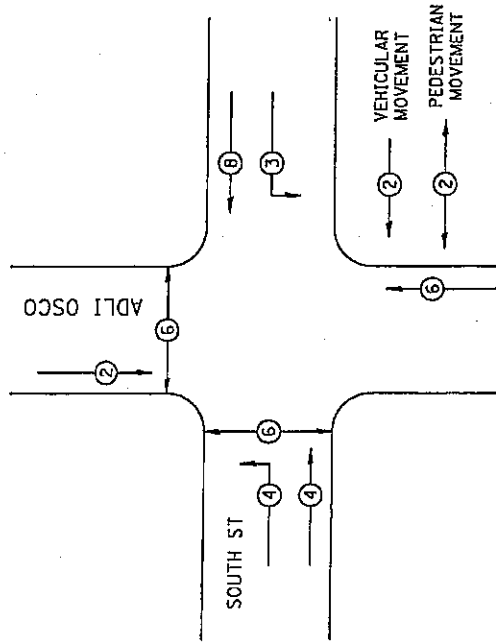

VEHICULAR MOVEMENT
 PEDESTRIAN MOVEMENT

NUMBER REFERS TO ASSOCIATED PHASE

REFER TO STANDARD 857001

INTERSECTION OF IL. SOUTH AT ALDI / OSCO ENTRANCE:

- REMOVE AND REPLACE EXISTING TRAFFIC SIGNAL EQUIPMENT
- 4 - PED BUTTON
- 4 - PED HEAD

RETRO-FIT THE FOLLOWING SIGNAL HEADS:

- 1 - 5 SECTION MAM
- 1 - 5 SECTION BM
- 1 - 4 SECTION MAM
- 7 - 3 SECTION MAM
- 4 - 3 SECTION BM

DESIGNED	REVISION	DATE	BY	REVISION	DATE	BY
DRAWN	REVISION	DATE	BY	REVISION	DATE	BY
CHECKED	REVISION	DATE	BY	REVISION	DATE	BY
DATE	REVISION	DATE	BY	REVISION	DATE	BY

SCALE: _____ SHEET NO. OF _____ SHEETS TO STA. _____ TO STA. _____

SOUTH AT ALDI
 PREPORT

STATE OF ILLINOIS
 DEPARTMENT OF TRANSPORTATION

CONTRACT NO. _____

SUBMITTAL IS PROJECT _____

SHEET 25 OF 29
 CONTRACT 64H30
 SEC D2 GREENLIGHT 2012-2
 VARIOUS ROUTES
 VARIOUS COUNTIES

PHASE DESIGNATION DIAGRAM

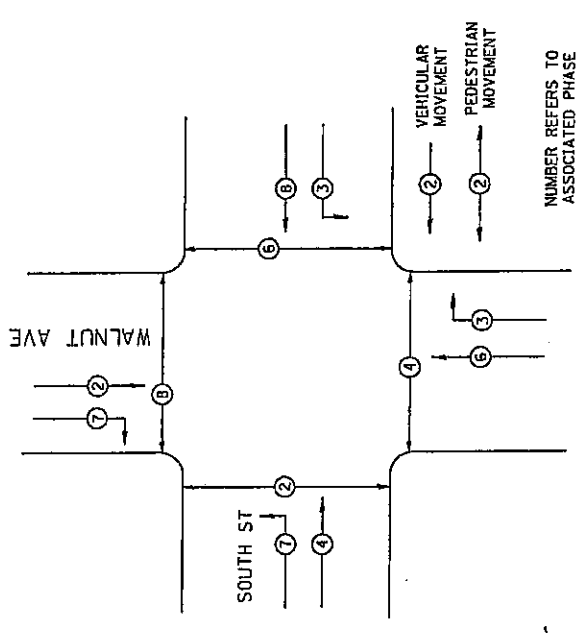

REFER TO STANDARD 857001

INTERSECTION OF IL SOUTH AT WALNUT AVE:

- REMOVE AND REPLACE EXISTING TRAFFIC SIGNAL EQUIPMENT
- 8 - PED BUTTON
- 8 - PED HEAD

RETRO-FIT THE FOLLOWING SIGNAL HEADS:

- 4 - 5 SECTION MAM
- 2 - 5 SECTION BM
- 8 - 3 SECTION MAM

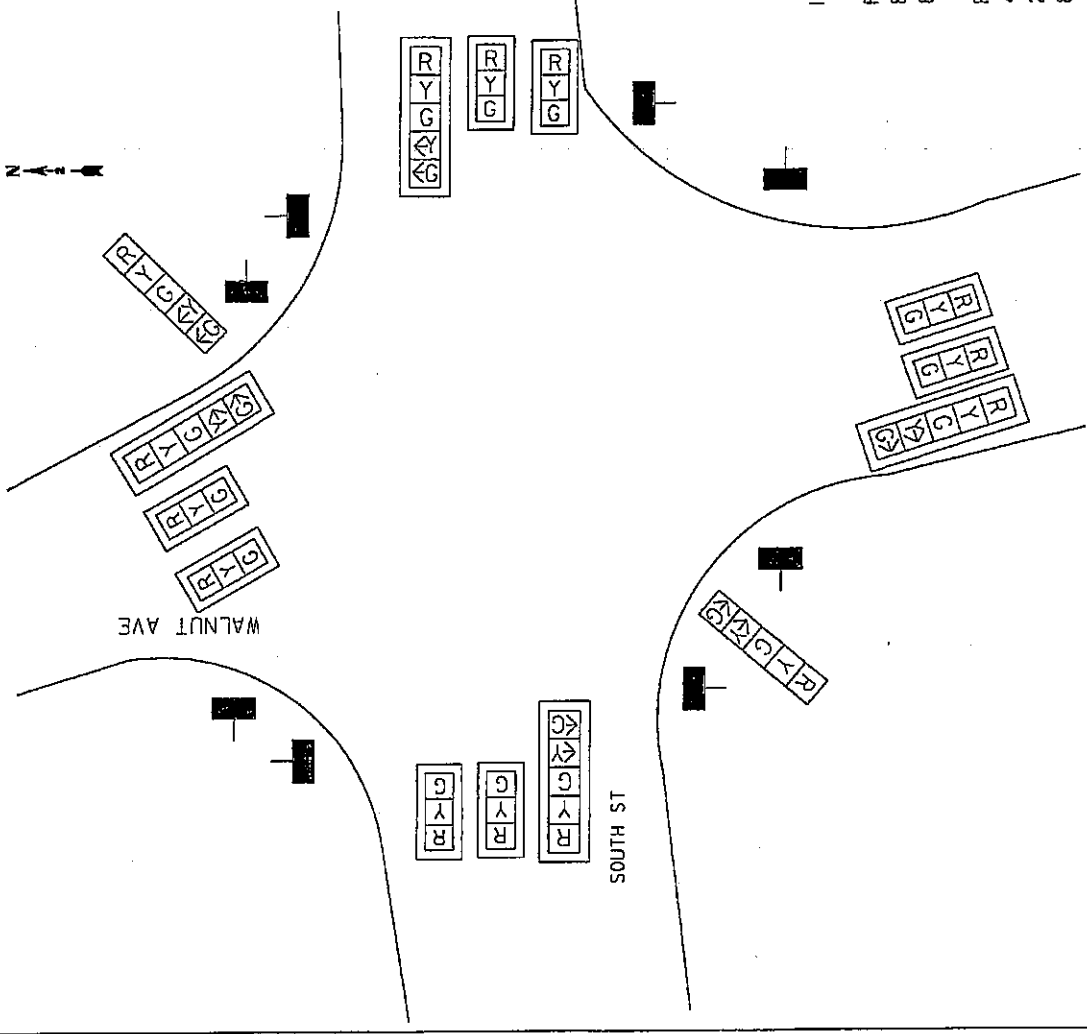
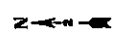

SHEET NO. 25 OF 29	COUNTY SECTION	SHEET NO. 25 OF 29	PROJECT NO.	CONTRACT NO.	DATE	DESIGNED CHECKED DATE	REVISIONS 1 2 3 4 5 6 7 8 9 10	STATE OF ILLINOIS DEPARTMENT OF TRANSPORTATION	SOUTH ST AT WALNUT AVE FREEPORT
									SCALE: _____ SHEET NO. 25 OF _____ SHEETS TOTAL TO STA. _____

Sheet 26 of 29
 Contract 64H30
 Various Counties
 Various Routes

Location	Retro fit			Replace head and backplate					Ped Head	Ped Buttons	BACKPLATE
	3-Section MAM	3-Section BM	5-Section MAM	3-Section MAM	3-Section BM	5-Section MAM	5-Section BM				
Morrison											
US 30 at Madison St	0	7	1	0	0	0	0	0	8	8	0
US 30 at IL 78	6	9	2						8	8	0
US 30 at Genesee				1	9	1	1	1	8	8	2

SHEET 27 OF 29
 CONTRACT 64H30
 SEC D2 GREENLIGHT 2012-2
 VARIOUS ROUTES
 VARIOUS COUNTIES

PHASE DESIGNATION DIAGRAM

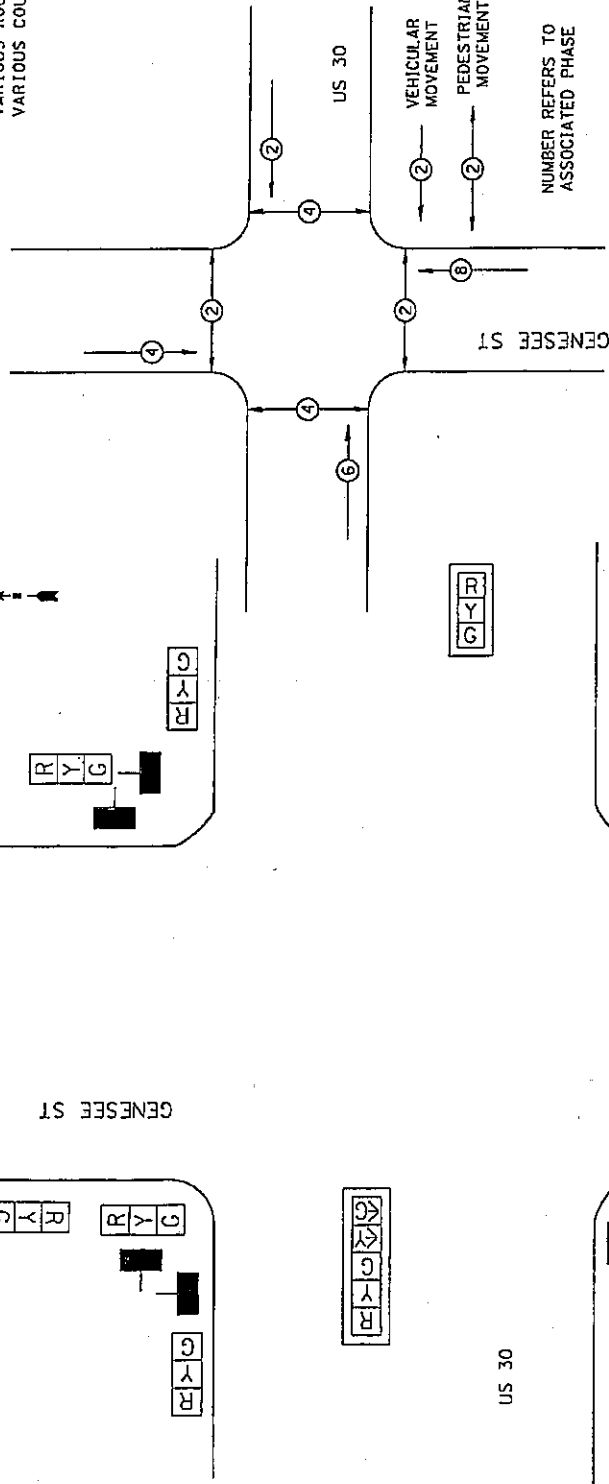

NUMBER REFERS TO ASSOCIATED PHASE

REFER TO STANDARD 857001

INTERSECTION OF US 30 AT GENESEE ST:

- REMOVE AND REPLACE EXISTING TRAFFIC SIGNAL EQUIPMENT
- 8 - PED BUTTON
- 8 - PED HEAD
- 1 - 5 SECTION MAM
- 1 - 3 SECTION MAM
- 1 - 5 SECTION BM
- 9 - 3 SECTION BM

DATE	BY	REVISION	SECTION	CONTRACT	SHEET
STATE OF ILLINOIS DEPARTMENT OF TRANSPORTATION			US RTE 30 AT GENESEE ROBINSON		
SHEET NO. 27 OF 29 SHEETS			TO ST.		

SHEET 28 OF 29
 CONTRACT 64H30
 SEC D2 GREENLIGHT 2012-2
 VARIOUS ROUTES
 VARIOUS COUNTIES

PHASE DESIGNATION DIAGRAM

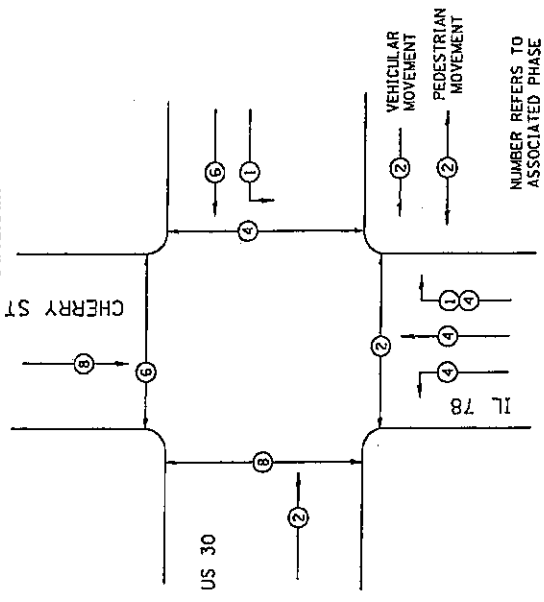

INTERSECTION OF US 30 AT IL 78 (CHERRY ST):

REMOVE AND REPLACE EXISTING TRAFFIC SIGNAL EQUIPMENT;

- 8 - PED BUTTON
- 8 - PED HEAD
- 2 - 5 SECTION MAM
- 1 - 5 SECTION BM
- 6 - 3 SECTION MAM
- 9 - 3 SECTION BM

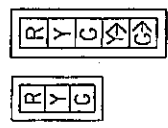
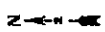

CHERRY ST

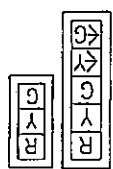

US 30

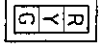
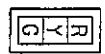
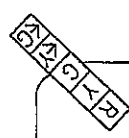

IL 78

DATE	BY	REVISION	DESCRIPTION	DATE	BY	REVISION	DESCRIPTION

FILE NO. 64H30-28
 10% COMPLETE
 DATE: 11/28/11
 11/28/11

DESIGNED BY: []
 DRAWN BY: []
 CHECKED BY: []
 DATE: []

STATE OF ILLINOIS
 DEPARTMENT OF TRANSPORTATION

US 30 AT IL 78 (CHERRY ST)
 MORRISON

SHEET NO. 28 OF 29
 TOTAL SHEETS 29
 CONTRACT NO. 64H30
 ILLUSTRATION NO. 28

SHEET 29 OF 29
 CONTRACT 64H30
 SEC D2 GREENLIGHT 2012-2
 VARIOUS ROUTES
 VARIOUS COUNTIES

PHASE DESIGNATION DIAGRAM

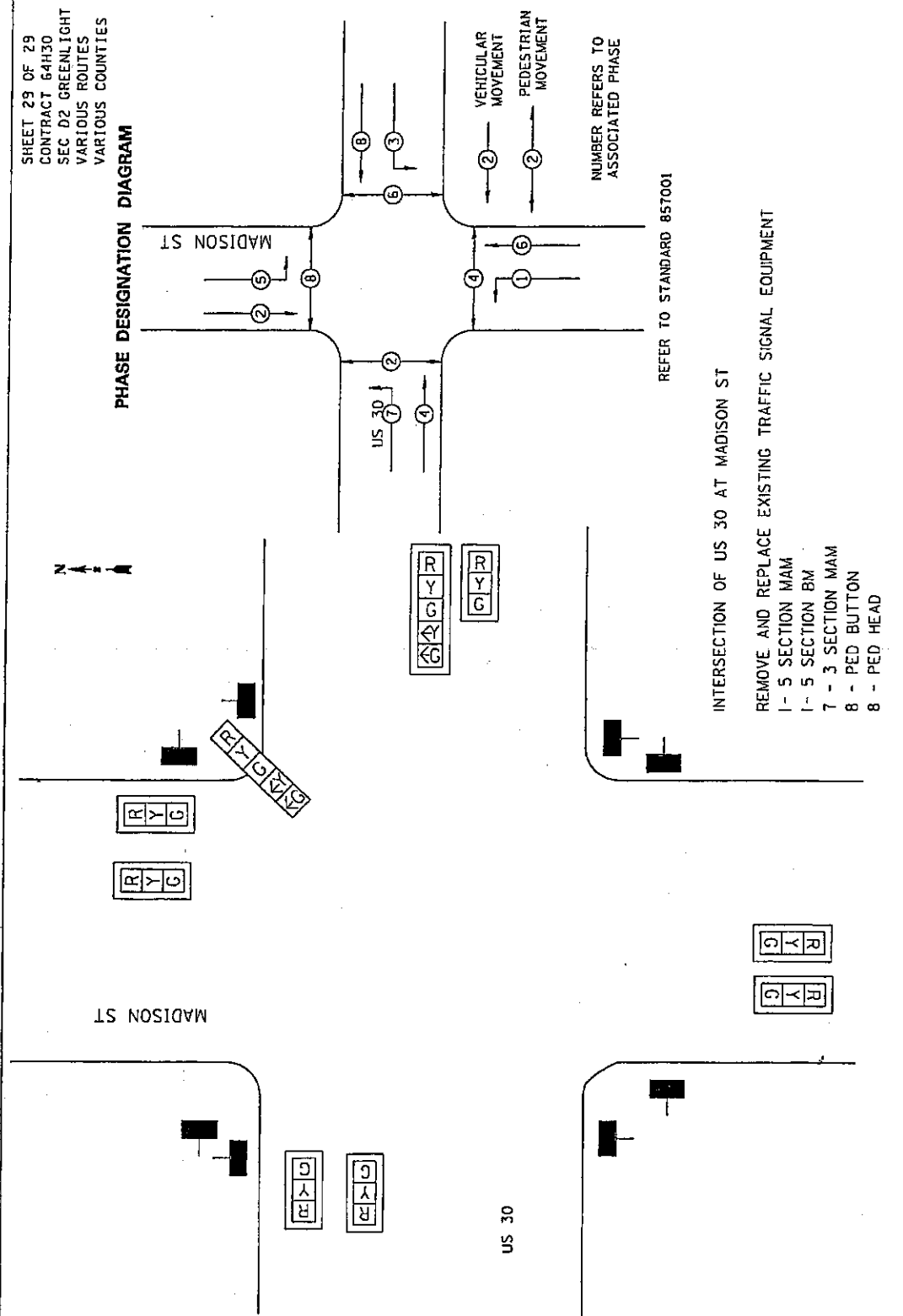

DATE	BY	CHECKED	DATE	SCALE	SHEET NO.	OF	TOTAL SHEETS
					29	31	
STATE OF ILLINOIS DEPARTMENT OF TRANSPORTATION				US 30 AT MADISON MADISON			
PROJECT NO.				CONTRACT NO.			
SHEET NO.				SUBJECT			

ILLINOIS DEPARTMENT OF LABOR

PREVAILING WAGES FOR G2 C:@FD COUNT:6 D EFFECTIVE FEBRUARY 2012

The Prevailing rates of wages are included in the Contract proposals which are subject to Check Sheet #5 of the Supplemental Specifications and Recurring Special Provisions. The rates have been ascertained and certified by the Illinois Department of Labor for the locality in which the work is to be performed and for each craft or type of work or mechanic needed to execute the work of the Contract. As required by Prevailing Wage Act (820 ILCS 130/0.01, et seq.) and Check Sheet #5 of the Contract, not less than the rates of wages ascertained by the Illinois Department of Labor and as revised during the performance of a Contract shall be paid to all laborers, workers and mechanics performing work under the Contract. Post the scale of wages in a prominent and easily accessible place at the site of work.

If the Illinois Department of Labor revises the prevailing rates of wages to be paid as listed in the specification of rates, the contractor shall post the revised rates of wages and shall pay not less than the revised rates of wages. Current wage rate information shall be obtained by visiting the Illinois Department of Labor web site at <http://www.state.il.us/agency/idol/> or by calling 312-793-2814. It is the responsibility of the contractor to review the rates applicable to the work of the contract at regular intervals in order to insure the timely payment of current rates. Provision of this information to the contractor by means of the Illinois Department of Labor web site satisfies the notification of revisions by the Department to the contractor pursuant to the Act, and the contractor agrees that no additional notice is required. The contractor shall notify each of its subcontractors of the revised rates of wages.

Boone County Prevailing Wage for February 2012

Trade Name	RG	TYP	C	Base	FRMAN	*M-F>8	OSA	OSH	H/W	Pensn	Vac	Trng
=====	==	===	=	=====	=====	=====	===	===	=====	=====	=====	=====
ASBESTOS ABT-GEN		ALL		35.200	35.700	1.5	1.5	2.0	12.18	8.820	0.000	0.450
ASBESTOS ABT-MEC		BLD		22.750	24.250	1.5	1.5	2.0	3.390	5.170	0.000	0.000
BOILERMAKER		BLD		43.450	47.360	2.0	2.0	2.0	6.970	12.61	0.000	0.350
BRICK MASON		BLD		37.210	39.960	1.5	1.5	2.0	7.400	11.73	0.000	0.570
CARPENTER		BLD		36.320	40.320	1.5	1.5	2.0	7.400	10.95	0.000	0.600
CARPENTER		HWY		37.280	39.030	1.5	1.5	2.0	7.400	9.000	0.000	0.490
CEMENT MASON		ALL		34.820	37.570	1.5	1.5	2.0	7.650	11.45	0.000	0.250
CERAMIC TILE FNSHER		BLD		32.240	0.000	1.5	1.5	2.0	7.400	4.840	0.000	0.500
COMMUNICATION TECH		BLD		36.000	39.600	1.5	1.5	2.0	9.740	11.20	0.000	0.720
ELECTRIC PWR EQMT OP		ALL		34.240	45.510	1.5	1.5	2.0	5.000	10.62	0.000	0.260
ELECTRIC PWR GRNDMAN		ALL		26.480	45.510	1.5	1.5	2.0	5.000	8.200	0.000	0.200
ELECTRIC PWR LINEMAN		ALL		41.000	45.510	1.5	1.5	2.0	5.000	12.71	0.000	0.310
ELECTRIC PWR TRK DRV		ALL		27.420	45.510	1.5	1.5	2.0	5.000	8.500	0.000	0.210
ELECTRICIAN		BLD		40.000	44.000	1.5	1.5	2.0	9.740	15.83	0.000	0.800
ELEVATOR CONSTRUCTOR		BLD		44.940	50.560	2.0	2.0	2.0	11.03	11.96	2.760	0.000
GLAZIER		BLD		32.730	33.730	1.5	1.5	2.0	8.950	8.200	0.000	1.250
HT/FROST INSULATOR		BLD		36.760	37.760	1.5	1.5	2.0	7.550	10.76	0.000	0.500
IRON WORKER		ALL		35.000	36.750	2.0	2.0	2.0	8.000	19.59	0.000	0.950
LABORER		ALL		35.200	35.950	1.5	1.5	2.0	11.97	9.030	0.000	0.450
LATHER		BLD		36.320	40.320	1.5	1.5	2.0	7.400	10.95	0.000	0.600
MACHINIST		BLD		43.160	45.160	1.5	1.5	2.0	7.980	8.950	0.000	0.000
MARBLE FINISHERS		BLD		32.240	0.000	1.5	1.5	2.0	7.400	4.840	0.000	0.500
MARBLE MASON		BLD		35.090	35.340	1.5	1.5	2.0	7.400	6.980	0.000	0.540
MATERIAL TESTER I		ALL		25.200	0.000	1.5	1.5	2.0	11.97	9.030	0.000	0.450
MATERIALS TESTER II		ALL		30.200	0.000	1.5	1.5	2.0	11.97	9.030	0.000	0.450
MILLWRIGHT		BLD		33.970	37.370	1.5	1.5	2.0	6.550	12.35	0.000	0.500
OPERATING ENGINEER		BLD	1	40.350	44.350	2.0	2.0	2.0	14.55	9.300	2.350	1.300
OPERATING ENGINEER		BLD	2	39.650	44.350	2.0	2.0	2.0	14.55	9.300	2.350	1.300
OPERATING ENGINEER		BLD	3	37.200	44.350	2.0	2.0	2.0	14.55	9.300	2.350	1.300
OPERATING ENGINEER		BLD	4	35.200	44.350	2.0	2.0	2.0	14.55	9.300	2.350	1.300
OPERATING ENGINEER		BLD	5	44.100	44.350	2.0	2.0	2.0	14.55	9.300	2.350	1.300
OPERATING ENGINEER		BLD	6	43.350	44.350	2.0	2.0	2.0	14.55	9.300	2.350	1.300
OPERATING ENGINEER		BLD	7	40.350	44.350	2.0	2.0	2.0	14.55	9.300	2.350	1.300
OPERATING ENGINEER		HWY	1	40.200	44.200	1.5	1.5	2.0	14.55	9.300	2.350	1.300
OPERATING ENGINEER		HWY	2	39.650	44.200	1.5	1.5	2.0	14.55	9.300	2.350	1.300
OPERATING ENGINEER		HWY	3	38.350	44.200	1.5	1.5	2.0	14.55	9.300	2.350	1.300
OPERATING ENGINEER		HWY	4	36.900	44.200	1.5	1.5	2.0	14.55	9.300	2.350	1.300
OPERATING ENGINEER		HWY	5	35.450	44.200	1.5	1.5	2.0	14.55	9.300	2.350	1.300
OPERATING ENGINEER		HWY	6	43.200	44.200	1.5	1.5	2.0	14.55	9.300	2.350	1.300
OPERATING ENGINEER		HWY	7	41.200	44.200	1.5	1.5	2.0	14.55	9.300	2.350	1.300
PAINTER		ALL		35.000	37.000	1.5	1.5	1.5	8.950	8.200	0.000	1.250
PAINTER SIGNS		BLD		33.920	38.090	1.5	1.5	1.5	2.600	2.710	0.000	0.000
PILEDRIIVER		BLD		37.320	41.430	1.5	1.5	2.0	7.400	10.95	0.000	0.600
PILEDRIIVER		HWY		37.280	39.030	1.5	1.5	2.0	7.400	9.000	0.000	0.490
PIPEFITTER		BLD		39.250	42.000	1.5	1.5	2.0	7.980	10.59	0.000	0.950
PLASTERER		BLD		33.360	36.700	1.5	1.5	2.0	7.650	11.05	0.000	0.250
PLUMBER		BLD		39.250	42.000	1.5	1.5	2.0	7.980	10.59	0.000	0.950
ROOFER		BLD		37.650	40.650	1.5	1.5	2.0	7.750	6.570	0.000	0.430
SHEETMETAL WORKER		BLD		35.450	37.380	1.5	1.5	2.0	5.250	14.77	0.520	0.290
SPRINKLER FITTER		BLD		36.140	38.890	1.5	1.5	2.0	8.100	8.200	0.000	0.350
STONE MASON		BLD		37.210	39.960	1.5	1.5	2.0	7.400	11.73	0.000	0.570
TERRAZZO FINISHER		BLD		32.240	0.000	1.5	1.5	2.0	7.400	4.840	0.000	0.500
TERRAZZO MASON		BLD		35.090	35.340	1.5	1.5	2.0	7.400	6.980	0.000	0.540
TILE LAYER		BLD		36.320	40.320	1.5	1.5	2.0	7.400	10.95	0.000	0.600
TILE MASON		BLD		35.090	35.340	1.5	1.5	2.0	7.400	6.980	0.000	0.540
TRUCK DRIVER		ALL	1	32.960	33.420	1.5	1.5	2.0	6.900	8.220	0.000	0.000
TRUCK DRIVER		ALL	2	33.110	33.420	1.5	1.5	2.0	6.900	8.220	0.000	0.000
TRUCK DRIVER		ALL	3	33.310	33.420	1.5	1.5	2.0	6.900	8.220	0.000	0.000

TRUCK DRIVER	ALL	4	33.420	33.420	1.5	1.5	2.0	6.900	8.220	0.000	0.000
TUCKPOINTER	BLD		37.210	39.960	1.5	1.5	2.0	7.400	11.73	0.000	0.570

Legend:

M-F>8 (Overtime is required for any hour greater than 8 worked each day, Monday through Friday.)

OSA (Overtime is required for every hour worked on Saturday)

OSH (Overtime is required for every hour worked on Sunday and Holidays)

H/W (Health & Welfare Insurance)

Pensn (Pension)

Vac (Vacation)

Trng (Training)

Explanations

BOONE COUNTY

The following list is considered as those days for which holiday rates of wages for work performed apply: New Years Day, Memorial Day, Fourth of July, Labor Day, Thanksgiving Day, Christmas Day and Veterans Day in some classifications/counties. Generally, any of these holidays which fall on a Sunday is celebrated on the following Monday. This then makes work performed on that Monday payable at the appropriate overtime rate for holiday pay. Common practice in a given local may alter certain days of celebration. If in doubt, please check with IDOL.

EXPLANATION OF CLASSES

ASBESTOS - GENERAL - removal of asbestos material/mold and hazardous materials from any place in a building, including mechanical systems where those mechanical systems are to be removed. This includes the removal of asbestos materials/mold and hazardous materials from ductwork or pipes in a building when the building is to be demolished at the time or at some close future date.

ASBESTOS - MECHANICAL - removal of asbestos material from mechanical systems, such as pipes, ducts, and boilers, where the mechanical systems are to remain.

CERAMIC TILE FINISHER, MARBLE FINISHER, TERRAZZO FINISHER

Assisting, helping or supporting the tile, marble and terrazzo mechanic by performing their historic and traditional work assignments required to complete the proper installation of the work covered by said crafts. The term "Ceramic" is used for naming the classification only and is in no way a limitation of the product handled. Ceramic takes into consideration most hard tiles.

COMMUNICATION TECHNICIAN

Installing, manufacturing, assembling and maintaining sound and intercom, protection alarm (security), fire alarm, master antenna

television, closed circuit television, low voltage control for computers and/or door monitoring, school communications systems, telephones and servicing of nurse and emergency calls, and the installation and maintenance of transmit and receive antennas, transmitters, receivers, and associated apparatus which operates in conjunction with above systems. All work associated with these system installations will be included EXCEPT the installation of protective metallic conduit in new construction projects (excluding less than ten-foot runs strictly for protection of cable) and 120 volt AC (or higher) power wiring and associated hardware.

MATERIAL TESTER I: Hand coring and drilling for testing of materials; field inspection of uncured concrete and asphalt.

MATERIAL TESTER II: Field inspection of welds, structural steel, fireproofing, masonry, soil, facade, reinforcing steel, formwork, cured concrete, and concrete and asphalt batch plants; adjusting proportions of bituminous mixtures.

OPERATING ENGINEERS - BUILDING

Class 1. Asphalt Plant; Asphalt Spreader; Autograde; Backhoes with Caisson Attachment; Batch Plant; Benoto (requires Two Engineers); Boiler and Throttle Valve; Caisson Rigs; Central Redi-Mix Plant; Combination Back Hoe Front End-loader Machine; Compressor and Throttle Valve; Concrete Breaker (Truck Mounted); Concrete Conveyor; Concrete Paver (over 27E cu. ft.): Concrete Paver (27 cu. ft. and under); Concrete Placer; Concrete Pump (Truck Mounted); Concrete Conveyor (Truck Mounted); Concrete Tower; Cranes, All; GCI and similar types (required two operators only); Cranes, Hammerhead; Creter Crane; Crusher, Stone, etc.; Derricks, All; Derricks, Traveling; Formless Curb and Gutter Machine; Grader, Elevating; Grouting Machines; Highlift Shovels or Front Endloader 2-1/4 yd. and over; Hoists, Elevators, outside type rack and pinion and similar machines; Hoists, one, two and three Drum; Hoists, Two Tugger One Floor; Hydraulic Backhoes; Hydraulic Boom Trucks; Locomotives, All; Lubrication Technician; Manipulators; Motor Patrol; Pile Drivers and Skid Rig; Post Hole Digger; Pre-Stress Machine; Pump Cretes Dual Ram; Pump Cretes: Squeeze Cretes - Screw Type Pumps, Gypsum Bulker and Pump; Raised and Blind Hole Drill; Rock Drill (self-propelled); Rock Drill - Truck Mounted; Roto Mill Grinder; Scoops - Tractor Drawn; Slipform Paver; Scrapers Prime Movers; Straddle Buggies; Tie Back Machine; Tractor with Boom and Side Boom; Trenching Machines.

Class 2. Bobcat (over 3/4 cu. yd.); Boilers; Brick Forklift; Broom, All Power Propelled; Bulldozers; Concrete Mixer (Two Bag and Over); Conveyor, Portable; Forklift Trucks; Highlift Shovels or Front Endloaders under 2-1/4 yd.; Hoists, Automatic; Hoists, Sewer Dragging Machine; Hoists, Tugger Single Drum; Rollers, All; Steam Generators; Tractors, All; Tractor Drawn Vibratory Roller; Winch Trucks with "A" Frame.

Class 3. Air Compressor; Asphalt Spreader; Combination - Small Equipment Operator; Generators; Heaters, Mechanical; Hoists, Inside Elevators - (Rheostat Manual Controlled); Hydraulic Power Units (Pile Driving and Extracting); Pumps, Over 3" (1 to 3 not to exceed total of 300 ft.); Pumps, Well Points; Welding Machines (2 through 5); Winches, 4 Small Electric Drill Winches; Bobcat (up to and including 3/4 cu. yd.).

Class 4. Elevator push button with automatic doors; Hoists, Inside; Oilers; Brick Forklift.

Class 5. Assistant Craft Foreman

Class 6. Mechanics

Class 7. Gradall

OPERATING ENGINEERS - HIGHWAY CONSTRUCTION

Class 1. Asphalt Plant; Asphalt Heater and Planer Combination; Asphalt Heater Scarfire; Asphalt Silo Tender; Asphalt Spreader; Autograder; ABG Paver; Backhoes with Caisson Attachment; Ballast Regulator; Belt Loader; Caisson Rigs; Car Dumper; Central Redi-Mix Plant; Backhoe w/shear attachments; Combination Backhoe Front Endloader Machine, (1 cu. yd. Backhoe Bucket or over or with attachments); Concrete Breaker (Truck Mounted); Concrete Conveyor; Concrete Paver over 27E cu. ft.; Concrete Placer; Concrete Tube Float; Cranes, all attachments; Cranes, Tower of all types; Creter Crane; Crusher, Stone, etc.; Derricks, All; Derrick Boats; Derricks, Traveling; Directional Boring Machine over 12"; Dredges; Formless Curb and Gutter Machine; Grader, Elevating; Grader, Motor Grader, Motor Patrol, Auto Patrol, Form Grader, Pull Grader, Subgrader; Guard Rail Post Driver Mounted; Hoists, One, Two and Three Drum; Hydraulic Backhoes; Lubrication Technician; Manipulators; Pile Drivers and Skid Rig; Pre-Stress Machine; Pump Cretes Dual Ram; Rock Drill - Crawler or Skid Rig; Rock Drill - Truck Mounted; Rock/Track Tamper; Roto Mill Grinder; Slip-Form Paver; Soil Test Drill Rig (Truck Mounted); Straddle Buggies; GCI Crane; Hydraulic Telescoping Form (Tunnel); Tie Back Machine; Tractor Drawn Belt Loader; Tractor Drawn Belt Loader with attached pusher; Tractor with Boom; Tractaire with Attachments; Traffic Barrier Conveyor Machine; Raised or Blind Hole Drills; Trenching Machine (over 12"); Truck Mounted Concrete Pump with Boom; Truck Mounted Concrete Conveyor; Underground Boring and/or Mining Machines; Wheel Excavator; Widener (APSCO).

Class 2. Batch Plant; Bituminous Mixer; Boiler and Throttle Valve; Bulldozers; Car Loader Trailing Conveyors; Combination Backhoe Front Endloader Machine (less than 1 cu. yd. Backhoe Bucket or over or with attachments); Compressor and Throttle Valve; Compressor, Common Receiver (3); Concrete Breaker or Hydro Hammer; Concrete Grinding Machine; Concrete Mixer or Paver 7S Series to and including 27 cu. ft.; Concrete Spreader; Concrete Curing Machine, Burlap Machine, Belting Machine and Sealing Machine; Conveyor Muck Cars (Haglund or Similar Type); Drills, all; Finishing Machine - Concrete; Highlift Shovels or Front Endloader; Hoist - Sewer Dragging Machine; Hydraulic Boom Trucks (All Attachments); Hydro Blaster; All Locomotives, Dinky; Off-Road Hauling Units (including articulating) / 2 ton capacity or more; Non-Self Loading Ejection Dump; Pump Cretes: Squeeze Cretes - Screw Type Pumps, Gypsum Bulker and Pump; Roller, Asphalt; Rotary Snow Plows; Rototiller, Seaman, etc., self-propelled; Scoops - Tractor Drawn; Self-Propelled Compactor; Spreader - Chip - Stone, etc.; Scraper; Scraper - Prime Mover in Tandem (Regardless of Size); Tank Car Heater; Tractors, Push, Pulling Sheeps Foot, Disc, Compactor, etc.; Tug Boats.

Class 3. Boilers; Brooms, All Power Propelled; Cement Supply Tender; Compressor, Common Receiver (2); Concrete Mixer (Two Bag and Over); Conveyor, Portable; Farm-Type Tractors Used for Mowing, Seeding, etc.; Fireman on Boilers; Forklift Trucks; Grouting Machine; Hoists, Automatic; Hoists, All Elevators; Hoists, Tugger Single Drum; Jeep Diggers; Low Boys; Pipe Jacking Machines; Post-Hole Digger; Power Saw, Concrete Power Driven; Pug Mills; Rollers, other than asphalt; Seed and Straw Blower; Steam Generators; Stump Machine; Winch Trucks with

"A" Frame; Work Boats; Tamper - Form - Motor Driven.

Class 4. Air Compressor - Small and Large; Asphalt Spreader, Backend Man; Bobcat (Skid Steer) all; Brick Forklift; Combination - Small Equipment Operator; Directional Boring Machine up to 12"; Generators; Heaters, Mechanical; Hydraulic Power Unit (Pile Driving, Extracting, or Drilling); Hydro-Blaster; Light Plants, All (1 through 5); Pumps, over 3" (1 to 3 not to exceed a total of 300 ft.); Pumps, Well Points; Tractaire; Trencher 12" and under; Welding Machines (2 through 5); Winches, 4 Small Electric Drill Winches.

Class 5. Oilers and Directional Boring Machine Locator.

Class 6. Field Mechanics and Field Welders

Class 7. Gradall and machines of like nature.

TRUCK DRIVER - BUILDING, HEAVY AND HIGHWAY CONSTRUCTION

Class 1. Two or three Axle Trucks. A-frame Truck when used for transportation purposes; Air Compressors and Welding Machines, including those pulled by cars, pick-up trucks and tractors; Ambulances; Batch Gate Lockers; Batch Hopperman; Car and Truck Washers; Carry-alls; Fork Lifts and Hoisters; Helpers; Mechanics Helpers and Greasers; Oil Distributors 2-man operation; Pavement Breakers; Pole Trailer, up to 40 feet; Power Mower Tractors; Self-propelled Chip Spreader; Skipman; Slurry Trucks, 2-man operation; Slurry Truck Conveyor Operation, 2 or 3 man; Teamters; Unskilled dumpman; and Truck Drivers hauling warning lights, barricades, and portable toilets on the job site.

Class 2. Four axle trucks; Dump Crets and Adgetors under 7 yards; Dumpsters, Track Trucks, Euclids, Hug Bottom Dump Turnapulls or Turnatrailers when pulling other than self-loading equipment or similar equipment under 16 cubic yards; Mixer Trucks under 7 yards; Ready-mix Plant Hopper Operator, and Winch Trucks, 2 Axles.

Class 3. Five axle trucks; Dump Crets and Adgetors 7 yards and over; Dumpsters, Track Trucks, Euclids, Hug Bottom Dump Turnatrailers or turnapulls when pulling other than self-loading equipment or similar equipment over 16 cubic yards; Explosives and/or Fission Material Trucks; Mixer Trucks 7 yards or over; Mobile Cranes while in transit; Oil Distributors, 1-man operation; Pole Trailer, over 40 feet; Pole and Expandable Trailers hauling material over 50 feet long; Slurry trucks, 1-man operation; Winch trucks, 3 axles or more; Mechanic--Truck Welder and Truck Painter.

Class 4. Six axle trucks; Dual-purpose vehicles, such as mounted crane trucks with hoist and accessories; Foreman; Master Mechanic; Self-loading equipment like P.B. and trucks with scoops on the front.

Other Classifications of Work:

For definitions of classifications not otherwise set out, the Department generally has on file such definitions which are available. If a task to be performed is not subject to one of the classifications of pay set out, the Department will upon being contacted state which neighboring county has such a classification and provide such rate, such rate being deemed to exist by reference in this document. If no neighboring county rate applies to the task, the Department shall undertake a special determination, such special determination being then deemed to have existed under this determination. If a project requires these, or any classification not

listed, please contact IDOL at 217-782-1710 for wage rates or clarifications.

LANDSCAPING

Landscaping work falls under the existing classifications for laborer, operating engineer and truck driver. The work performed by landscape plantsman and landscape laborer is covered by the existing classification of laborer. The work performed by landscape operators (regardless of equipment used or its size) is covered by the classifications of operating engineer. The work performed by landscape truck drivers (regardless of size of truck driven) is covered by the classifications of truck driver.

Carroll County Prevailing Wage for February 2012

Trade Name	RG	TYP	C	Base	FRMAN	*M-F>8	OSA	OSH	H/W	Pensn	Vac	Trng
=====	==	===	=	=====	=====	=====	===	===	=====	=====	=====	=====
ASBESTOS ABT-GEN		BLD		29.400	30.400	1.5	1.5	2.0	8.040	12.02	0.000	0.800
ASBESTOS ABT-MEC		BLD		20.500	21.500	1.5	1.5	2.0	6.250	3.500	0.000	0.000
BOILERMAKER		BLD		34.170	37.170	2.0	2.0	2.0	6.820	8.550	0.000	0.350
BRICK MASON		BLD		35.710	38.460	1.5	1.5	2.0	7.400	11.73	0.000	0.570
CARPENTER		BLD		32.040	35.560	1.5	1.5	2.0	8.520	12.87	0.000	0.600
CARPENTER		HWY		32.440	34.190	1.5	1.5	2.0	9.250	11.99	0.000	0.490
CEMENT MASON		ALL		32.520	35.270	1.5	1.5	2.0	7.400	13.78	0.000	0.250
CERAMIC TILE FNSHER		BLD		32.240	0.000	1.5	1.5	2.0	7.400	4.840	0.000	0.500
COMMUNICATION TECH	E	BLD		36.000	39.600	1.5	1.5	2.0	9.740	11.20	0.000	0.720
ELECTRIC PWR EQMT OP		ALL		34.240	45.510	1.5	1.5	2.0	5.000	10.62	0.000	0.260
ELECTRIC PWR GRNDMAN		ALL		26.480	45.510	1.5	1.5	2.0	5.000	8.200	0.000	0.200
ELECTRIC PWR LINEMAN		ALL		41.000	45.510	1.5	1.5	2.0	5.000	12.71	0.000	0.310
ELECTRIC PWR TRK DRV		ALL		27.420	45.510	1.5	1.5	2.0	5.000	8.500	0.000	0.210
ELECTRICIAN	E	BLD		40.000	44.000	1.5	1.5	2.0	9.740	15.83	0.000	0.800
ELECTRICIAN	W	BLD		31.520	33.520	1.5	1.5	2.0	7.220	10.52	0.000	0.310
ELECTRONIC SYS TECH	W	BLD		23.500	25.250	1.5	1.5	2.0	7.020	5.150	0.000	0.310
ELEVATOR CONSTRUCTOR		BLD		44.940	50.560	2.0	2.0	2.0	11.03	11.96	2.760	0.000
GLAZIER		BLD		21.840	23.140	1.5	1.5	2.0	6.670	6.120	0.000	0.350
HT/FROST INSULATOR		BLD		28.860	30.060	1.5	1.5	2.0	5.250	12.05	0.000	0.800
IRON WORKER	E	ALL		35.000	36.750	2.0	2.0	2.0	8.000	19.59	0.000	0.950
IRON WORKER	W	ALL		27.500	29.700	1.5	1.5	2.0	8.890	10.18	0.000	0.620
LABORER		BLD		29.400	30.400	1.5	1.5	2.0	8.040	12.02	0.000	0.800
LABORER		HWY		30.100	30.850	1.5	1.5	2.0	8.040	12.02	0.000	0.800
LABORER, SKILLED		HWY		32.250	33.000	1.5	1.5	2.0	8.040	12.02	0.000	0.800
LATHER		BLD		32.040	35.560	1.5	1.5	2.0	8.520	12.87	0.000	0.600
MACHINIST		BLD		43.160	45.160	1.5	1.5	2.0	7.980	8.950	0.000	0.000
MARBLE FINISHERS		BLD		32.240	0.000	1.5	1.5	2.0	7.400	4.840	0.000	0.500
MARBLE MASON		BLD		35.090	35.340	1.5	1.5	2.0	7.400	6.980	0.000	0.540
MATERIAL TESTER I		ALL		21.550	0.000	1.5	1.5	2.0	7.460	4.840	0.000	0.170
MATERIALS TESTER II		ALL		26.550	0.000	1.5	1.5	2.0	7.460	4.840	0.000	0.170
MILLWRIGHT		BLD		29.820	32.800	1.5	1.5	2.0	6.400	9.640	0.000	0.500
OPERATING ENGINEER		BLD	1	40.350	44.350	2.0	2.0	2.0	14.55	9.300	2.350	1.300
OPERATING ENGINEER		BLD	2	39.650	44.350	2.0	2.0	2.0	14.55	9.300	2.350	1.300
OPERATING ENGINEER		BLD	3	37.200	44.350	2.0	2.0	2.0	14.55	9.300	2.350	1.300
OPERATING ENGINEER		BLD	4	35.200	44.350	2.0	2.0	2.0	14.55	9.300	2.350	1.300
OPERATING ENGINEER		BLD	5	44.100	44.350	2.0	2.0	2.0	14.55	9.300	2.350	1.300
OPERATING ENGINEER		BLD	6	43.350	44.350	2.0	2.0	2.0	14.55	9.300	2.350	1.300
OPERATING ENGINEER		BLD	7	40.350	44.350	2.0	2.0	2.0	14.55	9.300	2.350	1.300
OPERATING ENGINEER		HWY	1	40.200	44.200	1.5	1.5	2.0	14.55	9.300	2.350	1.300
OPERATING ENGINEER		HWY	2	39.650	44.200	1.5	1.5	2.0	14.55	9.300	2.350	1.300
OPERATING ENGINEER		HWY	3	38.350	44.200	1.5	1.5	2.0	14.55	9.300	2.350	1.300
OPERATING ENGINEER		HWY	4	36.900	44.200	1.5	1.5	2.0	14.55	9.300	2.350	1.300
OPERATING ENGINEER		HWY	5	35.450	44.200	1.5	1.5	2.0	14.55	9.300	2.350	1.300
OPERATING ENGINEER		HWY	6	43.200	44.200	1.5	1.5	2.0	14.55	9.300	2.350	1.300
OPERATING ENGINEER		HWY	7	41.200	44.200	1.5	1.5	2.0	14.55	9.300	2.350	1.300
PAINTER		ALL		26.820	27.820	1.5	1.5	1.5	5.000	6.100	0.000	0.600
PAINTER OVER 30FT		ALL		28.070	29.070	1.5	1.5	1.5	5.000	6.100	0.000	0.600
PAINTER PWR EQMT		ALL		27.320	28.320	1.5	1.5	1.5	5.000	6.100	0.000	0.600
PILEDRIVER		BLD		33.040	36.670	1.5	1.5	2.0	8.520	12.87	0.000	0.600
PILEDRIVER		HWY		32.440	34.190	1.5	1.5	2.0	9.250	11.99	0.000	0.490
PIPEFITTER	E	BLD		39.250	42.000	1.5	1.5	2.0	7.980	10.59	0.000	0.950
PIPEFITTER	W	ALL		35.700	39.270	1.5	1.5	2.0	5.150	11.35	0.000	1.000
PLASTERER		BLD		33.360	36.700	2.0	2.0	2.0	7.650	11.05	0.000	0.250
PLUMBER	E	BLD		39.250	42.000	1.5	1.5	2.0	7.980	10.59	0.000	0.950
PLUMBER	W	ALL		35.700	39.270	1.5	1.5	2.0	5.150	11.35	0.000	1.000
ROOFER		BLD		37.650	40.650	1.5	1.5	2.0	7.750	6.570	0.000	0.430
SHEETMETAL WORKER		BLD		35.450	37.380	1.5	1.5	2.0	5.250	14.77	0.520	0.290
SPRINKLER FITTER		BLD		36.140	38.890	1.5	1.5	2.0	8.100	8.200	0.000	0.350

STONE MASON	BLD	35.710	38.460	1.5	1.5	2.0	7.400	11.73	0.000	0.570
TERRAZZO FINISHER	BLD	32.240	0.000	1.5	1.5	2.0	7.400	4.840	0.000	0.500
TERRAZZO MASON	BLD	35.090	35.340	1.5	1.5	2.0	7.400	6.980	0.000	0.540
TILE LAYER	BLD	32.040	35.560	1.5	1.5	2.0	8.520	12.87	0.000	0.600
TILE MASON	BLD	35.090	35.340	1.5	1.5	2.0	7.400	6.980	0.000	0.540
TRUCK DRIVER	ALL 1	30.350	0.000	1.5	1.5	2.0	10.05	4.610	0.000	0.250
TRUCK DRIVER	ALL 2	30.790	0.000	1.5	1.5	2.0	10.05	4.610	0.000	0.250
TRUCK DRIVER	ALL 3	30.990	0.000	1.5	1.5	2.0	10.05	4.610	0.000	0.250
TRUCK DRIVER	ALL 4	31.270	0.000	1.5	1.5	2.0	10.05	4.610	0.000	0.250
TRUCK DRIVER	ALL 5	32.090	0.000	1.5	1.5	2.0	10.05	4.610	0.000	0.250
TRUCK DRIVER	O&C 1	24.280	0.000	1.5	1.5	2.0	10.05	4.610	0.000	0.250
TRUCK DRIVER	O&C 2	24.630	0.000	1.5	1.5	2.0	10.05	4.610	0.000	0.250
TRUCK DRIVER	O&C 3	24.790	0.000	1.5	1.5	2.0	10.05	4.610	0.000	0.250
TRUCK DRIVER	O&C 4	25.020	0.000	1.5	1.5	2.0	10.05	4.610	0.000	0.250
TRUCK DRIVER	O&C 5	25.670	0.000	1.5	1.5	2.0	10.05	4.610	0.000	0.250
TUCKPOINTER	BLD	35.710	38.460	1.5	1.5	2.0	7.400	11.73	0.000	0.570

Legend:

M-F>8 (Overtime is required for any hour greater than 8 worked each day, Monday through Friday.)

OSA (Overtime is required for every hour worked on Saturday)

OSH (Overtime is required for every hour worked on Sunday and Holidays)

H/W (Health & Welfare Insurance)

Pensn (Pension)

Vac (Vacation)

Trng (Training)

Explanations

CARROLL COUNTY

COMMUNICATIONS TECHNICIAN (EAST) - Townships of Cherry Grove, Rock Creek, Shannon, Wysox, Lima, and Elkhorn Grove.

ELECTRICIANS (EAST) - Townships of Cherry Grove, Shannon, Rock Creek, Lima, Wysox, and Elkhorn Grove.

IRONWORKERS (EAST) - That part of the county East of a line between Fair Haven and Derinda Center (JoDaviess County).

PLUMBERS & PIPEFITTERS (EAST) - That part of the county East of Rt. 78 and including Mt. Carroll.

ELECTRONIC SYSTEMS TECHNICIAN -(WEST) - Portion west of Cherry Grove, Rock Creek and Wysox Townships.

The following list is considered as those days for which holiday rates of wages for work performed apply: New Years Day, Memorial Day, Fourth of July, Labor Day, Thanksgiving Day, Christmas Day and Veterans Day in some classifications/counties. Generally, any of these holidays which fall on a Sunday is celebrated on the following Monday. This then makes work performed on that Monday payable at the appropriate overtime rate for holiday pay. Common practice in a given

local may alter certain days of celebration. If in doubt, please check with IDOL.

Oil and chip resealing (O&C) means the application of road oils and liquid asphalt to coat an existing road surface, followed by application of aggregate chips or gravel to coated surface, and subsequent rolling of material to seal the surface.

EXPLANATION OF CLASSES

ASBESTOS - GENERAL - removal of asbestos material/mold and hazardous materials from any place in a building, including mechanical systems where those mechanical systems are to be removed. This includes the removal of asbestos materials/mold and hazardous materials from ductwork or pipes in a building when the building is to be demolished at the time or at some close future date.

ASBESTOS - MECHANICAL - removal of asbestos material from mechanical systems, such as pipes, ducts, and boilers, where the mechanical systems are to remain.

CERAMIC TILE FINISHER, MARBLE FINISHER, TERRAZZO FINISHER

Assisting, helping or supporting the tile, marble and terrazzo mechanic by performing their historic and traditional work assignments required to complete the proper installation of the work covered by said crafts. The term "Ceramic" is used for naming the classification only and is in no way a limitation of the product handled. Ceramic takes into consideration most hard tiles.

COMMUNICATIONS TECHNICIAN - East

Installing, manufacturing, assembling and maintaining sound and intercom, protection alarm (security), fire alarm, master antenna television, closed circuit television, low voltage control for computers and/or door monitoring, school communications systems, telephones and servicing of nurse and emergency calls, and the installation and maintenance of transmit and receive antennas, transmitters, receivers, and associated apparatus which operates in conjunction with above systems. All work associated with these system installations will be included EXCEPT the installation of protective metallic conduit in new construction projects (excluding less than ten-foot runs strictly for protection of cable) and 120 volt AC (or higher) power wiring and associated hardware.

ELECTRONIC SYSTEMS TECHNICIAN - West

Installing, assembling and maintaining sound and intercom, protection alarm (security), master antenna television, closed circuit television, computer hardware and software programming and installation to the network's outlet and input (EXCLUDING all cabling, power and cable termination work historically performed by wiremen), door monitoring and control, nurse and emergency call programming and installation to the system's outlet and input (EXCLUDING all cabling, power and cable termination work historically performed by wiremen), clock and timing; and the installation and maintenance of transmit and receive antennas, transmitters, receivers, and associated apparatus which operates in conjunction with the above systems. All work associated with these system installations will be included EXCEPT (1) installation of protective metallic conduit, excluding less than ten-foot runs strictly for protection of cable, and (2) 120 volt AC (or higher) power wiring and associated hardware.

LABORER, SKILLED - HIGHWAY

Individuals engaged in the following types of work, irrespective of the site of the work: asbestos abatement worker, handling of any materials with any foreign matter harmful to skin or clothing, track laborer, cement handlers, chloride handlers, the unloading and loading with steel workers and re-bars, concrete workers wet, tunnel helpers in free air, batch dumpers, mason tenders, kettle and tar men, tank cleaners, plastic installers, scaffold workers, motorized buggies or motorized unit used for wet concrete or handling of building materials, laborers with de-watering systems, sewer workers plus depth, rod and chainmen with technical engineers, rod and chainmen with land surveyors, rod and chainmen with surveyors, vibrator operators, cement silica, clay, fly ash, lime and plasters, handlers (bulk or bag), cofferdam workers plus depth, on concrete paving, placing, cutting and tying of reinforcing, deck hand, dredge hand, and shore laborers, bankmen on floating plant, grade checker, power tools, front end man on chip spreaders, cession workers plus depth, gunnite nozzle men, lead man on sewer work, welders, cutters, burners and torchmen, chainsaw operators, jackhammer and drill operators, layout man and/or drainage tile layer, steel form setter - street and highway, air tamping hammermen, signal man on crane, concrete saw operator, screedman on asphalt pavers, laborers tending masons with hot material or where foreign materials are used, mortar mixer operators, multiple concrete duct - leadsman, lumen, asphalt raker, curb asphalt machine operator, ready mix scalemen (permanent, portable or temporary plant), laborers handling masterplate or similar materials, laser beam operator, concrete burning machine operator, coring machine operator, plaster tender, underpinning and shoring of buildings, pump men, manhole and catch basin, dirt and stone tamper, hose men on concrete pumps, hazardous waste worker, lead base paint abatement worker, lining of pipe, refusing machine, assisting on direct boring machine, the work of laying watermain, fire hydrants, all mechanical joints to watermain work, sewer worker, and tapping water service and forced lift station mechanical worker.

MATERIAL TESTER I: Hand coring and drilling for testing of materials; field inspection of uncured concrete and asphalt.

MATERIAL TESTER II: Field inspection of welds, structural steel, fireproofing, masonry, soil, facade, reinforcing steel, formwork, cured concrete, and concrete and asphalt batch plants; adjusting proportions of bituminous mixtures.

OPERATING ENGINEERS - BUILDING

Class 1. Asphalt Plant; Asphalt Spreader; Autograde; Backhoes with Caisson Attachment; Batch Plant; Benoto (requires Two Engineers); Boiler and Throttle Valve; Caisson Rigs; Central Redi-Mix Plant; Combination Back Hoe Front End-loader Machine; Compressor and Throttle Valve; Concrete Breaker (Truck Mounted); Concrete Conveyor; Concrete Paver (over 27E cu. ft.): Concrete Paver (27 cu. ft. and under); Concrete Placer; Concrete Pump (Truck Mounted); Concrete Conveyor (Truck Mounted); Concrete Tower; Cranes, All; GCI and similar types (required two operators only); Cranes, Hammerhead; Creter Crane; Crusher, Stone, etc.; Derricks, All; Derricks, Traveling; Formless Curb and Gutter Machine; Grader, Elevating; Grouting Machines; Highlift Shovels or Front Endloader 2-1/4 yd. and over; Hoists, Elevators, outside type rack and pinion and similar machines; Hoists, one, two and three Drum; Hoists, Two Tugger One Floor; Hydraulic Backhoes; Hydraulic Boom Trucks; Locomotives, All; Lubrication Technician; Manipulators; Motor Patrol; Pile Drivers and Skid Rig; Post Hole Digger; Pre-Stress Machine; Pump Cretes Dual Ram; Pump

Cretes: Squeeze Cretes - Screw Type Pumps, Gypsum Bulker and Pump; Raised and Blind Hole Drill; Rock Drill (self-propelled); Rock Drill - Truck Mounted; Roto Mill Grinder; Scoops - Tractor Drawn; Slipform Paver; Scrapers Prime Movers; Straddle Buggies; Tie Back Machine; Tractor with Boom and Side Boom; Trenching Machines.

Class 2. Bobcat (over 3/4 cu. yd.); Boilers; Brick Forklift; Broom, All Power Propelled; Bulldozers; Concrete Mixer (Two Bag and Over); Conveyor, Portable; Forklift Trucks; Highlift Shovels or Front Endloaders under 2-1/4 yd.; Hoists, Automatic; Hoists, Sewer Dragging Machine; Hoists, Tugger Single Drum; Rollers, All; Steam Generators; Tractors, All; Tractor Drawn Vibratory Roller; Winch Trucks with "A" Frame.

Class 3. Air Compressor; Asphalt Spreader; Combination - Small Equipment Operator; Generators; Heaters, Mechanical; Hoists, Inside Elevators - (Rheostat Manual Controlled); Hydraulic Power Units (Pile Driving and Extracting); Pumps, Over 3" (1 to 3 not to exceed total of 300 ft.); Pumps, Well Points; Welding Machines (2 through 5); Winches, 4 Small Electric Drill Winches; Bobcat (up to and including 3/4 cu. yd.).

Class 4. Elevator push button with automatic doors; Hoists, Inside; Oilers; Brick Forklift.

Class 5. Assistant Craft Foreman

Class 6. Mechanics

Class 7. Gradall

OPERATING ENGINEERS - HIGHWAY CONSTRUCTION

Class 1. Asphalt Plant; Asphalt Heater and Planer Combination; Asphalt Heater Scarfire; Asphalt Silo Tender; Asphalt Spreader; Autograder; ABG Paver; Backhoes with Caisson Attachment; Ballast Regulator; Belt Loader; Caisson Rigs; Car Dumper; Central Redi-Mix Plant; Backhoe w/shear attachments; Combination Backhoe Front Endloader Machine, (1 cu. yd. Backhoe Bucket or over or with attachments); Concrete Breaker (Truck Mounted); Concrete Conveyor; Concrete Paver over 27E cu. ft.; Concrete Placer; Concrete Tube Float; Cranes, all attachments; Cranes, Tower of all types; Creter Crane; Crusher, Stone, etc.; Derricks, All; Derrick Boats; Derricks, Traveling; Directional Boring Machine over 12"; Dredges; Formless Curb and Gutter Machine; Grader, Elevating; Grader, Motor Grader, Motor Patrol, Auto Patrol, Form Grader, Pull Grader, Subgrader; Guard Rail Post Driver Mounted; Hoists, One, Two and Three Drum; Hydraulic Backhoes; Lubrication Technician; Manipulators; Pile Drivers and Skid Rig; Pre-Stress Machine; Pump Cretes Dual Ram; Rock Drill - Crawler or Skid Rig; Rock Drill - Truck Mounted; Rock/Track Tamper; Roto Mill Grinder; Slip-Form Paver; Soil Test Drill Rig (Truck Mounted); Straddle Buggies; GCI Crane; Hydraulic Telescoping Form (Tunnel); Tie Back Machine; Tractor Drawn Belt Loader; Tractor Drawn Belt Loader with attached pusher; Tractor with Boom; Tractaire with Attachments; Traffic Barrier Conveyor Machine; Raised or Blind Hole Drills; Trenching Machine (over 12"); Truck Mounted Concrete Pump with Boom; Truck Mounted Concrete Conveyor; Underground Boring and/or Mining Machines; Wheel Excavator; Widener (APSCO).

Class 2. Batch Plant; Bituminous Mixer; Boiler and Throttle Valve; Bulldozers; Car Loader Trailing Conveyors; Combination Backhoe Front Endloader Machine (less than 1 cu. yd. Backhoe Bucket or over or with

attachments); Compressor and Throttle Valve; Compressor, Common Receiver (3); Concrete Breaker or Hydro Hammer; Concrete Grinding Machine; Concrete Mixer or Paver 7S Series to and including 27 cu. ft.; Concrete Spreader; Concrete Curing Machine, Burlap Machine, Belting Machine and Sealing Machine; Conveyor Muck Cars (Haglund or Similar Type); Drills, all; Finishing Machine - Concrete; Highlift Shovels or Front Endloader; Hoist - Sewer Dragging Machine; Hydraulic Boom Trucks (All Attachments); Hydro Blaster; All Locomotives, Dinky; Off-Road Hauling Units (including articulating) / 2 ton capacity or more; Non-Self Loading Ejection Dump; Pump Cretes: Squeeze Cretes - Screw Type Pumps, Gypsum Bulker and Pump; Roller, Asphalt; Rotary Snow Plows; Rototiller, Seaman, etc., self-propelled; Scoops - Tractor Drawn; Self-Propelled Compactor; Spreader - Chip - Stone, etc.; Scraper; Scraper - Prime Mover in Tandem (Regardless of Size); Tank Car Heater; Tractors, Push, Pulling Sheeps Foot, Disc, Compactor, etc.; Tug Boats.

Class 3. Boilers; Brooms, All Power Propelled; Cement Supply Tender; Compressor, Common Receiver (2); Concrete Mixer (Two Bag and Over); Conveyor, Portable; Farm-Type Tractors Used for Mowing, Seeding, etc.; Fireman on Boilers; Forklift Trucks; Grouting Machine; Hoists, Automatic; Hoists, All Elevators; Hoists, Tugger Single Drum; Jeep Diggers; Low Boys; Pipe Jacking Machines; Post-Hole Digger; Power Saw, Concrete Power Driven; Pug Mills; Rollers, other than asphalt; Seed and Straw Blower; Steam Generators; Stump Machine; Winch Trucks with "A" Frame; Work Boats; Tamper - Form - Motor Driven.

Class 4. Air Compressor - Small and Large; Asphalt Spreader, Backend Man; Bobcat (Skid Steer) all; Brick Forklift; Combination - Small Equipment Operator; Directional Boring Machine up to 12"; Generators; Heaters, Mechanical; Hydraulic Power Unit (Pile Driving, Extracting, or Drilling); Hydro-Blaster; Light Plants, All (1 through 5); Pumps, over 3" (1 to 3 not to exceed a total of 300 ft.); Pumps, Well Points; Tractaire; Trencher 12" and under; Welding Machines (2 through 5); Winches, 4 Small Electric Drill Winches.

Class 5. Oilers and Directional Boring Machine Locator.

Class 6. Field Mechanics and Field Welders

Class 7. Gradall and machines of like nature.

TRUCK DRIVER - BUILDING, HEAVY AND HIGHWAY CONSTRUCTION

Class 1. Drivers on 2 axle trucks hauling less than 9 ton. Air compressor and welding machines and brooms, including those pulled by separate units, truck driver helpers, warehouse employees, mechanic helpers, greasers and tiremen, pickup trucks when hauling materials, tools, or workers to and from and on-the-job site, and fork lifts up to 6,000 lb. capacity.

Class 2. Two or three axle trucks hauling more than 9 ton but hauling less than 16 ton. A-frame winch trucks, hydrolift trucks, vector trucks or similar equipment when used for transportation purposes. Fork lifts over 6,000 lb. capacity, winch trucks, four axle combination units, and ticket writers.

Class 3. Two, three or four axle trucks hauling 16 ton or more. Drivers on water pulls, articulated dump trucks, mechanics and working forepersons, and dispatchers. Five axle or more combination units.

Class 4. Low Boy and Oil Distributors.

Class 5. Drivers who require special protective clothing while employed on hazardous waste work.

TRUCK DRIVER - OIL AND CHIP RESEALING ONLY.

This shall encompass laborers, workers and mechanics who drive contractor or subcontractor owned, leased, or hired pickup, dump, service, or oil distributor trucks. The work includes transporting materials and equipment (including but not limited to, oils, aggregate supplies, parts, machinery and tools) to or from the job site; distributing oil or liquid asphalt and aggregate; stock piling material when in connection with the actual oil and chip contract. The Truck Driver (Oil & Chip Resealing) wage classification does not include supplier delivered materials.

Other Classifications of Work:

For definitions of classifications not otherwise set out, the Department generally has on file such definitions which are available. If a task to be performed is not subject to one of the classifications of pay set out, the Department will upon being contacted state which neighboring county has such a classification and provide such rate, such rate being deemed to exist by reference in this document. If no neighboring county rate applies to the task, the Department shall undertake a special determination, such special determination being then deemed to have existed under this determination. If a project requires these, or any classification not listed, please contact IDOL at 217-782-1710 for wage rates or clarifications.

LANDSCAPING

Landscaping work falls under the existing classifications for laborer, operating engineer and truck driver. The work performed by landscape plantsman and landscape laborer is covered by the existing classification of laborer. The work performed by landscape operators (regardless of equipment used or its size) is covered by the classifications of operating engineer. The work performed by landscape truck drivers (regardless of size of truck driven) is covered by the classifications of truck driver.

Henry County Prevailing Wage for February 2012

Trade Name	RG	TYP	C	Base	FRMAN	*M-F>8	OSA	OSH	H/W	Pensn	Vac	Trng
=====	==	===	=	=====	=====	=====	===	===	=====	=====	=====	=====
ASBESTOS ABT-GEN		BLD		26.650	27.650	1.5	1.5	2.0	8.040	9.710	0.000	0.800
ASBESTOS ABT-GEN		HWY		25.010	25.510	1.5	1.5	2.0	8.040	9.200	0.000	0.800
ASBESTOS ABT-MEC		BLD		20.500	21.500	1.5	1.5	2.0	6.250	3.500	0.000	0.000
BOILERMAKER		BLD		34.170	37.170	2.0	2.0	2.0	6.820	8.550	0.000	0.350
BRICK MASON		BLD		36.100	37.100	1.5	1.5	2.0	8.470	7.600	0.000	0.550
CARPENTER		BLD		26.380	27.700	1.5	1.5	2.0	7.790	7.660	0.000	0.600
CARPENTER		HWY		27.640	29.390	1.5	1.5	2.0	8.230	10.34	0.000	0.450
CEMENT MASON		ALL		34.500	35.500	1.5	1.5	2.0	7.400	11.37	0.000	0.250
CERAMIC TILE FNSHER		BLD		32.240	0.000	1.5	1.5	2.0	7.400	4.840	0.000	0.500
COMMUNICATION TECH	SE	BLD		31.200	32.700	1.5	1.5	2.0	11.62	10.26	0.000	0.320
ELECTRIC PWR EQMT OP		ALL		35.440	0.000	1.5	1.5	2.0	5.000	10.98	0.000	0.270
ELECTRIC PWR GRNDMAN		ALL		24.320	0.000	1.5	1.5	2.0	5.000	7.540	0.000	0.180
ELECTRIC PWR LINEMAN		ALL		39.370	41.910	1.5	1.5	2.0	5.000	12.20	0.000	0.300
ELECTRIC PWR TRK DRV		ALL		25.510	0.000	1.5	1.5	2.0	5.000	7.920	0.000	0.190
ELECTRICIAN	NW	BLD		31.520	33.520	1.5	1.5	2.0	7.220	10.52	0.000	0.310
ELECTRICIAN	SE	BLD		37.950	41.370	1.5	1.5	2.0	12.47	14.45	0.000	1.200
ELECTRONIC SYS TECH	NW	BLD		23.500	25.250	1.5	1.5	2.0	7.020	5.150	0.000	0.310
ELEVATOR CONSTRUCTOR		BLD		39.140	44.030	2.0	2.0	2.0	11.03	11.96	2.350	0.000
GLAZIER		BLD		25.780	27.280	1.5	1.5	2.0	6.670	6.120	0.000	0.350
HT/FROST INSULATOR		BLD		28.860	30.060	1.5	1.5	2.0	5.250	12.05	0.000	0.800
IRON WORKER		ALL		27.500	29.700	1.5	1.5	2.0	8.890	10.18	0.000	0.620
LABORER		BLD		25.650	26.650	1.5	1.5	2.0	8.040	9.710	0.000	0.800
LABORER		HWY		24.010	24.510	1.5	1.5	2.0	8.040	9.200	0.000	0.800
LABORER, SKILLED		BLD		25.650	26.650	1.5	1.5	2.0	8.040	9.710	0.000	0.800
LABORER, SKILLED		HWY		24.310	24.810	1.5	1.5	2.0	8.040	9.200	0.000	0.800
LATHER		BLD		26.380	27.700	1.5	1.5	2.0	7.790	7.660	0.000	0.600
MACHINIST		BLD		43.160	45.160	1.5	1.5	2.0	7.980	8.950	0.000	0.000
MARBLE FINISHERS		BLD		32.240	0.000	1.5	1.5	2.0	7.400	4.840	0.000	0.500
MARBLE MASON		BLD		35.090	35.340	1.5	1.5	2.0	7.400	6.980	0.000	0.540
MILLWRIGHT	N	BLD		29.820	32.800	1.5	1.5	2.0	4.300	8.730	0.000	0.560
MILLWRIGHT	S	BLD		27.250	28.950	1.5	1.5	2.0	6.400	9.640	0.000	0.500
OPERATING ENGINEER		BLD	5	30.150	31.150	1.5	1.5	2.0	13.95	6.600	1.500	0.800
OPERATING ENGINEER		BLD	6	30.650	31.650	1.5	1.5	2.0	13.95	6.600	1.500	0.800
OPERATING ENGINEER		BLD	7	30.400	31.400	1.5	1.5	2.0	13.95	6.600	1.500	0.800
OPERATING ENGINEER	E	BLD	1	32.290	35.290	1.5	1.5	2.0	7.250	11.65	0.000	2.200
OPERATING ENGINEER	E	BLD	2	30.140	35.290	1.5	1.5	2.0	7.250	11.65	0.000	2.200
OPERATING ENGINEER	E	BLD	3	28.560	35.290	1.5	1.5	2.0	7.250	11.65	0.000	2.200
OPERATING ENGINEER	E	HWY	1	34.000	37.000	1.5	1.5	2.0	8.250	11.65	0.000	2.200
OPERATING ENGINEER	E	HWY	2	31.490	37.000	1.5	1.5	2.0	8.250	11.65	0.000	2.200
OPERATING ENGINEER	E	HWY	3	27.340	37.000	1.5	1.5	2.0	8.250	11.65	0.000	2.200
OPERATING ENGINEER	W	BLD	1	29.400	30.400	1.5	1.5	2.0	13.95	6.600	1.500	0.800
OPERATING ENGINEER	W	BLD	2	27.800	30.400	1.5	1.5	2.0	13.95	6.600	1.500	0.800
OPERATING ENGINEER	W	BLD	3	26.650	30.400	1.5	1.5	2.0	13.95	6.600	1.500	0.800
OPERATING ENGINEER	W	BLD	4	29.650	30.650	1.5	1.5	2.0	13.95	6.600	1.500	0.800
OPERATING ENGINEER	W	BLD	5	30.150	31.150	1.5	1.5	2.0	13.95	6.600	1.500	0.800
OPERATING ENGINEER	W	BLD	6	30.650	31.650	1.5	1.5	2.0	13.95	6.600	1.500	0.800
OPERATING ENGINEER	W	BLD	7	30.400	31.400	1.5	1.5	2.0	13.95	6.600	1.500	0.800
OPERATING ENGINEER	W	HWY	1	29.400	30.400	1.5	1.5	2.0	13.95	6.600	1.500	0.800
OPERATING ENGINEER	W	HWY	2	27.800	30.400	1.5	1.5	2.0	13.95	6.600	1.500	0.800
OPERATING ENGINEER	W	HWY	3	26.650	30.400	1.5	1.5	2.0	13.95	6.600	1.500	0.800
OPERATING ENGINEER	W	HWY	4	29.650	30.650	1.5	1.5	2.0	13.95	6.600	1.500	0.800
OPERATING ENGINEER	W	HWY	5	30.150	31.150	1.5	1.5	2.0	13.95	6.600	1.500	0.800
OPERATING ENGINEER	W	HWY	6	30.650	31.650	1.5	1.5	2.0	13.95	6.600	1.500	0.800
OPERATING ENGINEER	W	HWY	7	29.900	30.900	1.5	1.5	2.0	13.95	6.600	1.500	0.800
OPERATING ENGINEER	W	HWY	8	30.400	31.400	1.5	1.5	2.0	13.95	6.600	1.500	0.800
PAINTER		ALL		26.820	27.820	1.5	1.5	1.5	5.000	6.100	0.000	0.600
PAINTER OVER 30FT		ALL		28.070	29.070	1.5	1.5	1.5	5.000	6.100	0.000	0.600
PAINTER PWR EQMT		ALL		27.320	28.320	1.5	1.5	1.5	5.000	6.100	0.000	0.600

PILEDRIVER	BLD	26.380	27.700	1.5	1.5	2.0	7.790	7.660	0.000	0.600
PILEDRIVER	HWY	27.640	29.390	1.5	1.5	2.0	8.230	10.34	0.000	0.450
PIPEFITTER	ALL	35.700	39.270	1.5	1.5	2.0	5.150	11.35	0.000	1.000
PLASTERER	BLD	34.500	35.500	1.5	1.5	2.0	7.400	11.37	0.000	0.250
PLUMBER	ALL	35.700	39.270	1.5	1.5	2.0	5.150	11.35	0.000	1.000
ROOFER	BLD	24.630	25.880	1.5	1.5	2.0	8.110	5.370	0.000	0.250
SHEETMETAL WORKER	BLD	29.930	31.920	1.5	1.5	2.0	7.140	10.24	0.000	0.540
SPRINKLER FITTER	BLD	36.140	38.890	1.5	1.5	2.0	8.100	8.200	0.000	0.350
STONE MASON	BLD	36.100	37.100	1.5	1.5	2.0	8.470	7.600	0.000	0.550
TERRAZZO FINISHER	BLD	32.240	0.000	1.5	1.5	2.0	7.400	4.840	0.000	0.500
TILE LAYER	BLD	26.380	27.700	1.5	1.5	2.0	7.790	7.660	0.000	0.600
TILE MASON	BLD	35.090	35.340	1.5	1.5	2.0	7.400	6.980	0.000	0.540
TRUCK DRIVER	ALL 1	30.460	0.000	1.5	1.5	2.0	10.05	4.775	0.000	0.250
TRUCK DRIVER	ALL 2	30.890	0.000	1.5	1.5	2.0	10.05	4.775	0.000	0.250
TRUCK DRIVER	ALL 3	31.120	0.000	1.5	1.5	2.0	10.05	4.775	0.000	0.250
TRUCK DRIVER	ALL 4	31.380	0.000	1.5	1.5	2.0	10.05	4.775	0.000	0.250
TRUCK DRIVER	ALL 5	32.200	0.000	1.5	1.5	2.0	10.05	4.775	0.000	0.250
TRUCK DRIVER	O&C 1	24.370	0.000	1.5	1.5	2.0	10.05	4.775	0.000	0.250
TRUCK DRIVER	O&C 2	24.710	0.000	1.5	1.5	2.0	10.05	4.775	0.000	0.250
TRUCK DRIVER	O&C 3	24.900	0.000	1.5	1.5	2.0	10.05	4.775	0.000	0.250
TRUCK DRIVER	O&C 4	25.100	0.000	1.5	1.5	2.0	10.05	4.775	0.000	0.250
TRUCK DRIVER	O&C 5	25.760	0.000	1.5	1.5	2.0	10.05	4.775	0.000	0.250
TUCKPOINTER	BLD	36.100	37.100	1.5	1.5	2.0	8.470	7.600	0.000	0.550

Legend:

M-F>8 (Overtime is required for any hour greater than 8 worked each day, Monday through Friday.)

OSA (Overtime is required for every hour worked on Saturday)

OSH (Overtime is required for every hour worked on Sunday and Holidays)

H/W (Health & Welfare Insurance)

Pensn (Pension)

Vac (Vacation)

Trng (Training)

Explanations

HENRY COUNTY

COMMUNICATIONS TECHNICIAN (SE) - Townships of Annawan, Cambridge, Burns, Kewanee, Weller, Galva, and Wethersfield.

ELECTRICIANS AND ELECTRONIC SYSTEMS TECHNICIAN (NW) - That portion North and West of Annawan, Burns, Cambridge, and Weller Townships.

MILLWRIGHT (NORTH) - North of interstate 80.

OPERATING ENGINEERS (EAST) - The eastern half of the county divided by highway 82 excluding Geneseo.

The following list is considered as those days for which holiday rates of wages for work performed apply: New Years Day, Memorial Day, Fourth of July, Labor Day, Thanksgiving Day, Christmas Day and Veterans Day in some classifications/counties. Generally, any of

these holidays which fall on a Sunday is celebrated on the following Monday. This then makes work performed on that Monday payable at the appropriate overtime rate for holiday pay. Common practice in a given local may alter certain days of celebration. If in doubt, please check with IDOL.

Oil and chip resealing (O&C) means the application of road oils and liquid asphalt to coat an existing road surface, followed by application of aggregate chips or gravel to coated surface, and subsequent rolling of material to seal the surface.

EXPLANATION OF CLASSES

ASBESTOS - GENERAL - removal of asbestos material/mold and hazardous materials from any place in a building, including mechanical systems where those mechanical systems are to be removed. This includes the removal of asbestos materials/mold and hazardous materials from ductwork or pipes in a building when the building is to be demolished at the time or at some close future date.

ASBESTOS - MECHANICAL - removal of asbestos material from mechanical systems, such as pipes, ducts, and boilers, where the mechanical systems are to remain.

CERAMIC TILE FINISHER, MARBLE FINISHER, TERRAZO FINISHER

Assisting, helping or supporting the tile, marble and terrazzo mechanic by performing their historic and traditional work assignments required to complete the proper installation of the work covered by said crafts. The term "Ceramic" is used for naming the classification only and is in no way a limitation of the product handled. Ceramic takes into consideration most hard tiles.

COMMUNICATIONS TECHNICIAN - Southeast

Installation, operation, inspection, maintenance, repair and service of radio, television, recording, voice, sound and vision production and reproduction, telephone and telephone interconnect, facsimile, equipment and appliances used for domestic, commercial, educational and entertainment purposes, pulling of wire through conduit but not the installation of conduit.

ELECTRONIC SYSTEMS TECHNICIAN - Northwest

Installing, assembling and maintaining sound and intercom, protection alarm (security), master antenna television, closed circuit television, computer hardware and software programming and installation to the network's outlet and input (EXCLUDING all cabling, power and cable termination work historically performed by wiremen), door monitoring and control, nurse and emergency call programming and installation to the system's outlet and input (EXCLUDING all cabling, power and cable termination work historically performed by wiremen), clock and timing; and the installation and maintenance of transmit and receive antennas, transmitters, receivers, and associated apparatus which operates in conjunction with the above systems. All work associated with these system installations will be included EXCEPT (1) installation of protective metallic conduit, excluding less than ten-foot runs strictly for protection of cable, and (2) 120 volt AC (or higher) power wiring and associated hardware.

LABORER, SKILLED - BUILDING

The skilled laborer building (BLD) classification shall encompass the following types of work, irrespective of the site of the work: tending of carpenters in unloading, handling, stockpiling and distribution operations, also other building crafts, mixing, handling, and conveying of all materials used by masons, plasterers and other building construction crafts, whether done by hand or by any process. The drying of plastering when done by salamander heat, and the cleaning and clearing of all debris. All work pertaining to and in preparation of asbestos abatement and removal. The building of scaffolding and staging for masons and plasterers. The excavations for buildings and all other construction, digging, of trenches, piers, foundations and holes, digging, lagging, sheeting, cribbing, bracing and propping of foundations, holes, caissons, cofferdams, and dikes, the setting of all guidelines for machine or hand excavation and subgrading. The mixing, handling, conveying, pouring, vibrating, gunniting and otherwise applying of concrete, whether by hand or other method of concrete for any walls, foundations, floors, or for other construction concrete sealant men. The wrecking, stripping, dismantling, and handling of concrete forms and false work, and the building of centers for fireproofing purposes. Boring machine, gas, electric or air in preparation for shoving pipe, telephone cable, and so forth, under highways, roads, streets and alleys. All hand and power operating cross cut saws when used for clearing. All work in compressed air construction. All work on acetylene burners in salvaging. The blocking and tamping of concrete. The laying of sewer tile and conduit, and pre-cast materials. The assembling and dismantling of all jacks and sectional scaffolding, including elevator construction and running of slip form jacks. The work of drill running and blasting, including wagon drills. The wrecking, stripping, dismantling, cleaning, moving and oiling of forms. The cutting off of concrete piles. The loading, unloading, handling and carrying to place of installation of all rods, (and materials for use in reinforcing) concrete and the hoisting of same and all signaling where hoist is used in this type of construction coming under the jurisdiction of the Laborers' Union. And, all other labor work not awarded to any other craft. Mortar mixers, kettlemen and carrier of hot stuff, tool crib men, watchmen (Laborer), firemen or salamander tenders, flagmen, deck hands, installation and maintenance of temporary gas-fired heating units, gravel box men, dumpmen and spotters, fencing Laborers, cleaning lumber, pit men, material checkers, dispatchers, unloading explosives, asphalt plant laborers, writer of scale tickets, fireproofing laborers, janitors, asbestos abatement and removal laborers, handling of materials treated with oil, creosote, chloride, asphalt, and/or foreign material harmful to skin or clothing, Laborers with de-watering systems, gunnite nozzle men, laborers tending masons with hot material or where foreign materials are used, Laborers handling masterplate or similar materials, laser beam operator, concrete burning machine operator, material selector men working with firebrick or combustible material, dynamite men, track laborers, cement handlers, chloride handlers, the unloading and laborers with steel workers and re-bars, concrete workers (wet), luteman, asphalt raker, curb asphalt machine operator, ready mix scalemen, permanent, portable or temporary plant drilling machine operator, plaster tenders, underpinning and shoring of buildings, fire watch, signaling of all power equipment, to include trucks excavating equipment, etc., tree topper or trimmer when in connection to construction, tunnel helpers in free air, batch dumpers, kettle and tar men, tank cleaners, plastic installers, scaffold workers, motorized buggies or motorized unit used for wet concrete or handling of building materials, sewer workers, rod and chain men, vibrator operators, mortar mixer operator, cement silica, clay, fly ash, lime and plasters, handlers (bulk or bag), cofferdam workers, on concrete paving, placing, cutting and tying of reinforcing, deck hand,

dredge hand and shore laborers, bankmen on floating plant, asphalt workers with machine & layers, grade checker, power tools, caisson workers, lead man on sewer work, welders, cutters, burners and torch men, chain saw operators, paving breaker, jackhammer and drill operator, layout man and/or drainage tile layer, steel form setters -- street and highway, air tamping hammerman, signal man on crane, concrete saw operator, screen man on asphalt pavers, front end man on chip spreader, multiple concrete duct -- lead man.

LABORER, SKILLED - HIGHWAY

The skilled laborer heavy and highway (HWY) classification shall encompass the following types of work, irrespective of the site of the work: handling of materials treated with oil, creosote, asphalt and/or any foreign materials harmful to skin or clothing, track laborers, chloride handlers, the unloading and loading with steel workers and re-bars, concrete workers (wet), tunnel helpers in free air, batch dumpers, mason tenders, kettle and tar men, plastic installers, scaffold workers, motorized buggies or motorized unit used for wet concrete or handling of building materials, laborers with de-watering systems, sewer workers plus depth, rod and chainmen, vibrator operators, mortar mixer operators, cement silica, clay, fly ash, lime and plasters, handlers (bulk or bag), cofferdam workers plus depth, on concrete paving, placing, cutting and tying or reinforcing, deck hand, dredge hand shore laborers, bankmen on floating plant, asphalt workers with machine, and layers, grade checker, power tools, stripping of all concrete forms excluding paving forms, dumpmen and spotters, when necessary, caisson workers plus depth, gunnite nozzle men, welders, cutters, burners and torchmen, chain saw operators, paving breaker, jackhammer and drill operators, layout man and/or drainage tile layer, steel form setters - street and highway, air tamping hammerman, signal man on crane, concrete saw operator, screedman on asphalt pavers, front end man on chip spreader, multiple concrete duct, luteman, asphalt raker, curb asphalt machine operator, ready mix scalemen (portable or temporary plant), laser beam operator, concrete burning machine operator, and coring machine operator.

OPERATING ENGINEERS - BUILDING (West)

Class 1. Shovel; Concrete Spreader; Dipper Dredge Operator; Dipper Dredge Crane man; Dual Purpose Truck (boom, Boom, Winch, etc.); Mechanic-Welder; Pile Driver; Boom Tractor or Side Boom; Trenching Machine (40 H.P. and over); Building Hoist (1, 2 or 3 drums); Cleaning and Priming Machine; Backfiller (throw bucket); Locomotive Engineer; Concrete Paver; Slip Form Paver; Caisson Augering Machines; Mucking Machine; Asphalt Heater-Planer Unit; Laser Screed; Pug Mill; Concrete Conveyor or Pump; Mechanical loaded Log Chippers or similar machines; Group Equipment Greaser; Off-Road Haul Units; Pipe Bending; Automatic Curbing Machines; Blastholer; Self-Propelled Rotary Drill or similar machines; Work Boat; Combination Concrete Finishing Machine and Float; Asphalt Paver Screed Operator; Forklift (6,000 lb. cap. or over or working heights 28 ft. and above); Chip Spreader; Straddle Carrier; Asphalt Paver; Asphalt Plant Operator; Boring Machine (Directional, Vertical, or Horizontal); Central Redi-Mix Plant Operator; Combination Backhoe Front End loader; Concrete Breaker or Hydro-Hammer (excluding walk-behinds); Concrete Wheel Saw (Large self-propelled - excluding walk-behinds); Crusher (Stone, Concrete, Asphalt, etc.); Curing-Tinning Machine; Excavator; Farm-type Tractor Operating Scoop or Scraper or with Power Attachment; Grader; Motor Grader; Motor Patrol; Auto Grader; Form Grader; Pull Grader; Sub Grader; Elevating Grader; Guard Rail Post Driver; Hoists; Hydraulic Dredge Leverman or Engineer; Hydro-Vac truck mounted or pull type (excluding hose work),

and similar equipment; Loader (Track, Rubber Tire, or Articulated); Milling Machine (excluding walk-behinds); Road Widener-Shoulder Spreader; Scraper (Self-Propelled); Self-Propelled Roller or Tire Roller (on asphalt or Blacktop); Sheep Foot or Pad Foot Compactor (excluding walk-behinds); Steel Track-Type Tractor (Dozer, Push Cat, etc.); Transfer or Shuttle Buggy (excluding motorized wheel barrows and Georgia buggies).

Class 2. Asphalt Booster; Fireman and Pump Operator at Asphalt Plant; Mud Jack; Distributor; Self-propelled Roller (other than provided for in Class I); Pump Operator (more than one well-point pump); Trench Machine (under 40 H.P.); Forklift (less than 6,000 lb. cap. or working heights below 28 ft.); Gypsum Pump; Conveyor over 20 H.P.; Light Plant; Boiler (Engineer or Fireman); Mechanical Broom; Driver on Truck Crane or similar machines; Elevator (Permanent inside or Temporary outside); Farm-Type Tractor (without Power Attachment); Grout Pump (excluding hose work).

Class 3. Skid Loader; Oiler; Mechanic's Helper; Mechanical Heater (other than steam boiler); Small Outboard Motor Boat (Safety Boat and Life Boat); Engine Driven Welding Machine; Water Pumps; Air Compressor (400 c.f.m. or over); Deck Engineers.

Class 4. Leadman - Mechanic or Equipment Greaser.

Class 5. Track Excavator with Bucket (4 cubic yard and up to but not including 6 cubic yard).

Class 6. Track Excavator with Bucket (6 cubic yard and over).

Class 7. Crane (Friction or Hydraulic, regardless of size or attachments); Tow or Push Boat.

OPERATING ENGINEERS- HIGHWAY (West)

Class 1. Shovel; Concrete Spreader; Dipper Dredge Operator; Dipper Dredge Crane man; Dual Purpose Truck (Boom, Winch, etc.); Mechanic-Welder; Pile Driver; Boom Tractor or Side Boom; Building Hoist (1, 2 or 3 drums); Cleaning and Priming Machine; Backfiller (throw bucket); Locomotive Engineer; Concrete Paver; Slip Form Paver; Caisson Augering Machines; Mucking Machine; Asphalt Heater Planer Unit; Laser Screed; Pug Mill; Concrete Conveyor or Pump (excluding truck-mounted); Mechanical loaded Log Chippers or similar machines; Group Equipment Greaser; off-road haul units; Pipe Bending; Automatic Curbing Machines; Blastholer; Self-propelled Rotary Drill or similar machines; Work Boat; Combination Concrete Finishing Machine and Float; Asphalt Paver Screed Operator; Forklift (6,000 lb. cap. or over or working heights above 28 ft.); Chip Spreader; Asphalt Paver; Asphalt Plant Operator; Boring Machine (Directional, Vertical, or Horizontal); Central Redi-Mix Plant Operator; Combination Backhoe Front End loader; Concrete Breaker or Hydro-Hammer (excluding walk-behinds); Concrete Wheel Saw (Large self-propelled - excluding walk-behinds); Crusher (Stone, Concrete, Asphalt, etc.); Curing-Tinning Machine; Excavator; Farm-Type Tractor Operating Scoop or Scraper with Power Attachment; Grader; Motor Grader; Motor Patrol; Auto Grader; Form Grader; Pull Grader; Sub Grader; Elevating Grader; Guard Rail Post Driver; Hoists; Hydraulic Dredge Leverman or Engineer; Hydro-Vac truck mounted or pull type, and similar equipment; Loader (Track, Rubber Tire, or Articulated); Milling Machine (excluding walk-behinds); Road Widener-Shoulder Spreader; Scraper (self-propelled); Self-propelled Roller or Tire Roller (on asphalt or Blacktop); Sheep Foot or Pad Foot Compactor (excluding walk-behinds); Steel Track-Type Tractor (Dozer, Push Cat, etc.); Transfer or Shuttle Buggy (excluding motorized wheel

barrows and Georgia buggies); Trenching Machine (40 H.P. and over).

Class 2. Asphalt Booster; Fireman and Pump Operator at Asphalt Plant; Mud Jack; Farm-Type Tractor without Power attachment; Distributor; Straddle Carrier; Self-propelled Roller or Compactor (other than provided for in Class I); Pump Operator (more than one well-point pump); Trench Machine (under 40 H.P.); Forklift (less than 6,000 lb. capacity or working heights below 28 ft.); Conveyor over 20 H.P.; Air Compressor (400 c.f.m. or over); Light Plant; Boiler (Engineer or Fireman); Mechanical Broom; Driver on Truck Crane or similar machines; Elevator (Permanent inside or Temporary outside); Grout Pump (excluding hose work).

Class 3. Oiler; Mechanic's Helper; Mechanical Heater (other than steam boiler); Small Outboard Motor Boat (Safety Boat and Life Boat); Engine Driven Welding Machine; skid steer.

Class 4. Leadman - Mechanic or Equipment Greaser.

Class 5. Track Excavator with Bucket (4 cubic yard and up to but not including 6 cubic yard).

Class 6. Track Excavator with Bucket (6 cubic yard and over).

Class 7. Truck mounted Concrete Conveyor or Pumps Extending to 90 ft. or more.

Class 8. Crane (Friction or Hydraulic, regardless of size or attachments); Tow or Push Boat.

OPERATING ENGINEERS - BUILDING - EAST

Class 1. Cranes; Overhead Cranes; Gradall; All Cherry Pickers; Mechanics; Central Concrete Mixing Plant Operator; Road Pavers (27E - Dual Drum - Tri Batchers); Blacktop Plant Operators and Plant Engineers; 3 Drum Hoist; Derricks; Hydro Cranes; Shovels; Skimmer Scoops; Koehring Scooper; Drag Lines; Backhoe; Derrick Boats; Pile Drivers and Skid Rigs; Clamshells; Locomotive Cranes; Dredge (all types) Motor Patrol; Power Blades - Dumore - Elevating and similar types; Tower Cranes (Crawler-Mobile) and Stationary; Crane-type Backfiller; Drott Yumbo and similar types considered as Cranes; Caisson Rigs; Dozer; Tournadozer; Work Boats; Ross Carrier; Helicopter; Tournapulls - all and similar types; Scoops (all sizes); Pushcats; Endloaders (all types); Asphalt Surfacing Machine; Slip Form Paver; Rock Crusher; Heavy Equipment Greaser; CMI, CMI Belt Placer, Auto Grade & 3 Track and similar types; Side Booms; Multiple Unit Earth Movers; Creter Crane; Trench Machine; Pump-crete-Belt Crete-Squeeze Cretes-Screw-type Pumps and Gypsum; Bulker & Pump - Operator will clean; Formless Finishing Machine; Flaherty Spreader or similar types; Screed Man on Laydown Machine; Wheel Tractors (industrial or Farm-type w/Dozer-Hoe-Endloader or other attachments); F.W.D. & Similar Types; Vermeer Concrete Saw.

Class 2. Dinkeys; Power Launches; PH One-pass Soil Cement Machine (and similar types); Pugmill with Pump; Backfillers; Euclid Loader; Forklifts; Jeeps w/Ditching Machine or other attachments; Tuneluger; Automatic Cement and Gravel Batching Plants; Mobile Drills (Soil Testing) and similar types; Gurries and Similar Types; (1) and (2) Drum Hoists (Buck Hoist and Similar Types); Chicago Boom; Boring Machine & Pipe Jacking Machine; Hydro Boom; Dewatering System; Straw Blower; Hydro Seeder; Assistant Heavy Equipment Greaser on Spread; Tractors (Track type) without Power Unit pulling Rollers; Rollers on

Asphalt -- Brick Macadem; Concrete Breakers; Concrete Spreaders; Mule Pulling Rollers; Center Stripper; Cement Finishing Machines & CMI Texture & Reel Curing Machines; Cement Finishing Machine; Barber Green or similar loaders; Vibro Tamper (All similar types) Self-propelled; Winch or Boom Truck; Mechanical Bull Floats; Mixers over 3 Bag to 27E; Tractor pulling Power Blade or Elevating Grader; Porter Rex Rail; Clary Screed; Truck Type Hoptoe Oilers; Fireman; Spray Machine on Paving; Curb Machines; Truck Crane Oilers; Oil Distributor; Truck-Mounted Saws.

Class 3. Air Compressor; Power Subgrader; Straight Tractor; Trac Air without attachments; Herman Nelson Heater, Dravo, Warner, Silent Glo, and similar types; Roller: Five (5) Ton and under on Earth or Gravel; Form Grader; Crawler Crane & Skid Rig Oilers; Freight Elevators - permanently installed; Pump; Light Plant; Generator; Conveyor (1) or (2) - Operator will clean; Welding Machine; Mixer (3) Bag and Under (Standard Capacity with skip); Bulk Cement Plant; Oiler on Central Concrete Mixing Plant.

OPERATING ENGINEERS - HEAVY AND HIGHWAY CONSTRUCTION - EAST

CLASS 1. Cranes; Hydro Cranes; Shovels; Crane Type Backfiller; Tower, Mobile, Crawler, & Stationary Cranes; Derricks; Hoists (3 Drum); Draglines; Drott Yumbo & Similar Types considered as Cranes; 360 Degree Swing Excavator (Shears, Grapples, Movacs, etc.); Back Hoe; Derrick Boats; Pile Driver and Skid Rigs; Clam Shell; Locomotive - Cranes; Road Pavers - Single Drum - Dual Drum - Tri Batcher; Motor Patrols & Power Blades - Dumore - Elevating & Similar Types; Mechanics; Central Concrete Mixing Plant Operator; Asphalt Batch Plant Operators and Plant Engineers; Gradall; Caisson Rigs; Skimmer Scoop - Koering Scooper; Dredges (all types); Hoptoe; All Cherry Pickers; Work Boat; Ross Carrier; Helicopter; Dozer; Tournadozer; Tournapulls - all and similar types; Operation of Concrete and all Recycle Machines; Multiple Unit Earth Movers; Scoops (all sizes); Pushcats; Endloaders (all types); Asphalt Surfacing Machine; Slip Form Paver; Rock Crusher; Operation of Material Crusher, Screening Plants, and Tunnel Boring Machine; Heavy Equipment Greaser (top greaser on spread); CMI, Auto Grade, CMI Belt Placer & 3 Track and Similar Types; Side Booms; Asphalt Heater & Planer Combination (used to plane streets); Wheel Tractors (with Dozer, Hoe or Endloader Attachments); CAT Earthwork Compactors and Similar Types; Blaw Knox Spreader and Similar Types; Trench Machines; Pump Crete - Belt Crete - Squeeze Crete - Screw Type Pumps and Gypsum (operator will clean); Creter Crane; Operation of Concrete Pump Truck; Formless Finishing Machines; Flaherty Spreader or Similar Types; Screed Man on Laydown Machine; Vermeer Concrete Saw; Operation of Laser Screed; Span Saw; Dredge Leverman; Dredge Engineer; Lull or Similar Type; Hydro-Boom Truck; Operation of Guard Rail Machine; and Starting Engineer on Pipeline or Construction (11 or more pieces) including: Air Compressor (Trailer Mounted), All Forced Air Heaters (regardless of Size), Water Pumps (Greater than 4-1/2" or Total Discharge Over 4-1/2"), Light Plants, Generators (Trailer Mounted - Excluding Decontamination Trailer), Welding Machines (Any Size or Mode of Power), Conveyor, Mixer (any size), Stud Welder, Power Pac, etc, and Ground Heater (Trailer Mounted).

CLASS 2. Bulker & Pump; Power Launches; Boring Machine & Pipe Jacking Machine; Dinkeys; Operation of Carts, Powered Haul Unit for a Boring Machine; P & H One Pass Soil Cement Machines and Similar Types; Wheel Tractors (Industry or Farm Type - Other); Back Fillers; Euclid Loader; Fork Lifts; Jeep w/Ditching Machine or Other Attachments; Tunneluger; Automatic Cement & Gravel Batching Plants; Mobile Drills - Soil Testing and Similar Types; Pugmill with Pump; All (1) and (2) Drum

Hoists; Dewatering System; Straw Blower; Hydro-Seeder; Bump Grinders (self-propelled); Assistant Heavy Equipment Greaser; Apsco Spreader; Tractors (Track-Type) without Power Units Pulling Rollers; Rollers on Asphalt - Brick or Macadam; Concrete Breakers; Concrete Spreaders; Cement Strippers; Cement Finishing Machines & CMI Texture & Reel Curing Machines; Vibro-Tampers (All Similar Types Self-Propelled); Mechanical Bull Floats; Self-Propelled Concrete Saws; Truck Mounted Power Saws; Operation of Curb Cutters; Mixers - Over Three (3) Bags; Winch and Boom Trucks; Tractor Pulling Power Blade or Elevating Grader; Porter Rex Rail; Clary Screed; Mule Pulling Rollers; Pugmill without Pump; Barber Greene or Similar Loaders; Track Type Tractor w/Power Unit attached (minimum); Fireman; Spray Machine on Paving; Curb Machines; Paved Ditch Machine; Power Broom; Self-Propelled Sweepers; Self-Propelled Conveyors; Power Subgrader; Oil Distributor; Straight Tractor; Truck Crane Oiler; Truck Type Oilers; Directional Boring Machine; Horizontal Directional Drill; Articulating End Dump Vehicles; Starting Engineer on Pipeline or Construction (6 -10 pieces) including: Air Compressor (Trailer Mounted), All Forced Air Heaters (regardless of Size), Water Pumps (Greater than 4-1/2" or Total Discharge Over 4-1/2"), Light Plants, Generators (Trailer Mounted - Excluding Decontamination Trailer), Welding Machines (Any Size or Mode of Power), Conveyor, Mixer (any size), Stud Welder, Power Pac, etc., and Ground Heater (Trailer Mounted).

CLASS 3. Straight Framed Truck Mounted Vac Unit (separately powered); Trac Air Machine (without attachments); Rollers - Five Ton and Under on Earth and Gravel; Form Graders; Bulk Cement Plant; Oilers; and Starting Engineer on Pipeline or Construction (3 - 5 pieces) including: Air Compressor (Trailer Mounted), All Forced Air Heaters (regardless of Size), Water Pumps (Greater than 4-1/2" or Total Discharge Over 4-1/2"), Light Plants, Generators (Trailer Mounted - Excluding Decontamination Trailer), Welding Machines (Any Size or Mode of Power), Conveyor, Mixer (any size), Stud Welder, Power Pac, etc., and Ground Heater (Trailer Mounted).

TRUCK DRIVER - BUILDING, HEAVY AND HIGHWAY CONSTRUCTION

Class 1. Drivers on 2 axle trucks hauling less than 9 ton. Air compressor and welding machines and brooms, including those pulled by separate units, truck driver helpers, warehouse employees, mechanic helpers, greasers and tiremen, pickup trucks when hauling materials, tools, or workers to and from and on-the-job site, and fork lifts up to 6,000 lb. capacity.

Class 2. Two or three axle trucks hauling more than 9 ton but hauling less than 16 ton. A-frame winch trucks, hydrolift trucks, vector trucks or similar equipment when used for transportation purposes. Fork lifts over 6,000 lb. capacity, winch trucks, four axle combination units, and ticket writers.

Class 3. Two, three or four axle trucks hauling 16 ton or more. Drivers on water pulls, articulated dump trucks, mechanics and working forepersons, and dispatchers. Five axle or more combination units.

Class 4. Low Boy and Oil Distributors.

Class 5. Drivers who require special protective clothing while employed on hazardous waste work.

TRUCK DRIVER - OIL AND CHIP RESEALING ONLY.

This shall encompass laborers, workers and mechanics who drive contractor or subcontractor owned, leased, or hired pickup, dump,

service, or oil distributor trucks. The work includes transporting materials and equipment (including but not limited to, oils, aggregate supplies, parts, machinery and tools) to or from the job site; distributing oil or liquid asphalt and aggregate; stock piling material when in connection with the actual oil and chip contract. The Truck Driver (Oil & Chip Resealing) wage classification does not include supplier delivered materials.

Other Classifications of Work:

For definitions of classifications not otherwise set out, the Department generally has on file such definitions which are available. If a task to be performed is not subject to one of the classifications of pay set out, the Department will upon being contacted state which neighboring county has such a classification and provide such rate, such rate being deemed to exist by reference in this document. If no neighboring county rate applies to the task, the Department shall undertake a special determination, such special determination being then deemed to have existed under this determination. If a project requires these, or any classification not listed, please contact IDOL at 217-782-1710 for wage rates or clarifications.

LANDSCAPING

Landscaping work falls under the existing classifications for laborer, operating engineer and truck driver. The work performed by landscape plantsman and landscape laborer is covered by the existing classification of laborer. The work performed by landscape operators (regardless of equipment used or its size) is covered by the classifications of operating engineer. The work performed by landscape truck drivers (regardless of size of truck driven) is covered by the classifications of truck driver.

Jo Daviess County Prevailing Wage for February 2012

Trade Name	RG	TYP	C	Base	FRMAN	*M-F>8	OSA	OSH	H/W	Pensn	Vac	Trng
=====	==	===	=	=====	=====	=====	===	===	=====	=====	=====	=====
ASBESTOS ABT-GEN		BLD		29.400	30.400	1.5	1.5	2.0	8.040	12.02	0.000	0.800
ASBESTOS ABT-MEC		BLD		20.500	21.500	1.5	1.5	2.0	6.250	3.500	0.000	0.000
BOILERMAKER		BLD		34.170	37.170	2.0	2.0	2.0	6.820	8.550	0.000	0.350
BRICK MASON		BLD		35.710	38.460	1.5	1.5	2.0	7.400	11.73	0.000	0.570
CARPENTER		BLD		27.040	29.040	1.5	1.5	2.0	7.000	8.540	0.000	0.450
CARPENTER		HWY		32.440	34.190	1.5	1.5	2.0	9.250	11.99	0.000	0.490
CEMENT MASON		ALL		32.520	35.270	1.5	1.5	2.0	7.400	13.78	0.000	0.250
CERAMIC TILE FNSHER		BLD		32.240	0.000	1.5	1.5	2.0	7.400	4.840	0.000	0.500
COMMUNICATION TECH		BLD		36.000	39.600	1.5	1.5	2.0	9.740	11.20	0.000	0.720
ELECTRIC PWR EQMT OP		ALL		34.240	45.510	1.5	1.5	2.0	5.000	10.62	0.000	0.260
ELECTRIC PWR GRNDMAN		ALL		26.480	45.510	1.5	1.5	2.0	5.000	8.200	0.000	0.200
ELECTRIC PWR LINEMAN		ALL		41.000	45.510	1.5	1.5	2.0	5.000	12.71	0.000	0.310
ELECTRIC PWR TRK DRV		ALL		27.420	45.510	1.5	1.5	2.0	5.000	8.500	0.000	0.210
ELECTRICIAN	E	BLD		40.000	44.000	1.5	1.5	2.0	9.740	15.83	0.000	0.800
ELECTRICIAN	W	BLD		29.000	30.450	1.5	1.5	2.0	6.000	7.070	0.000	0.290
ELEVATOR CONSTRUCTOR		BLD		44.940	50.560	2.0	2.0	2.0	11.03	11.96	2.760	0.000
GLAZIER		BLD		21.840	23.140	1.5	1.5	2.0	6.670	6.120	0.000	0.350
HT/FROST INSULATOR		BLD		28.860	30.060	1.5	1.5	2.0	5.250	12.05	0.000	0.800
IRON WORKER	E	ALL		35.000	36.750	2.0	2.0	2.0	8.000	19.59	0.000	0.950
IRON WORKER	W	ALL		27.500	29.700	1.5	1.5	2.0	8.890	10.18	0.000	0.620
LABORER		BLD		29.400	30.400	1.5	1.5	2.0	8.040	12.02	0.000	0.800
LABORER		HWY		30.100	30.850	1.5	1.5	2.0	8.040	12.02	0.000	0.800
LABORER, SKILLED		HWY		32.250	33.000	1.5	1.5	2.0	8.040	12.02	0.000	0.800
LATHER		BLD		27.040	29.040	1.5	1.5	2.0	7.000	8.540	0.000	0.450
MACHINIST		BLD		43.160	45.160	1.5	1.5	2.0	7.980	8.950	0.000	0.000
MARBLE FINISHERS		BLD		32.240	0.000	1.5	1.5	2.0	7.400	4.840	0.000	0.500
MARBLE MASON		BLD		35.090	35.340	1.5	1.5	2.0	7.400	6.980	0.000	0.540
MILLWRIGHT		BLD		33.970	37.370	1.5	1.5	2.0	6.550	12.35	0.000	0.500
OPERATING ENGINEER		BLD	1	40.350	44.350	2.0	2.0	2.0	14.55	9.300	2.350	1.300
OPERATING ENGINEER		BLD	2	39.650	44.350	2.0	2.0	2.0	14.55	9.300	2.350	1.300
OPERATING ENGINEER		BLD	3	37.200	44.350	2.0	2.0	2.0	14.55	9.300	2.350	1.300
OPERATING ENGINEER		BLD	4	35.200	44.350	2.0	2.0	2.0	14.55	9.300	2.350	1.300
OPERATING ENGINEER		BLD	5	44.100	44.350	2.0	2.0	2.0	14.55	9.300	2.350	1.300
OPERATING ENGINEER		BLD	6	43.350	44.350	2.0	2.0	2.0	14.55	9.300	2.350	1.300
OPERATING ENGINEER		BLD	7	40.350	44.350	2.0	2.0	2.0	14.55	9.300	2.350	1.300
OPERATING ENGINEER		HWY	1	40.200	44.200	1.5	1.5	2.0	14.55	9.300	2.350	1.300
OPERATING ENGINEER		HWY	2	39.650	44.200	1.5	1.5	2.0	14.55	9.300	2.350	1.300
OPERATING ENGINEER		HWY	3	38.350	44.200	1.5	1.5	2.0	14.55	9.300	2.350	1.300
OPERATING ENGINEER		HWY	4	36.900	44.200	1.5	1.5	2.0	14.55	9.300	2.350	1.300
OPERATING ENGINEER		HWY	5	35.450	44.200	1.5	1.5	2.0	14.55	9.300	2.350	1.300
OPERATING ENGINEER		HWY	6	43.200	44.200	1.5	1.5	2.0	14.55	9.300	2.350	1.300
OPERATING ENGINEER		HWY	7	41.200	44.200	1.5	1.5	2.0	14.55	9.300	2.350	1.300
PAINTER		ALL		35.000	37.000	1.5	1.5	1.5	8.950	8.200	0.000	1.250
PILEDRIVER		BLD		29.040	31.040	1.5	1.5	2.0	7.000	8.540	0.000	0.450
PILEDRIVER		HWY		32.440	34.190	1.5	1.5	2.0	9.250	11.99	0.000	0.490
PIPEFITTER		BLD		39.250	42.000	1.5	1.5	2.0	7.980	10.59	0.000	0.950
PLASTERER		BLD		33.360	36.700	2.0	2.0	2.0	7.650	11.05	0.000	0.250
PLUMBER		BLD		39.250	42.000	1.5	1.5	2.0	7.980	10.59	0.000	0.950
ROOFER		BLD		37.650	40.650	1.5	1.5	2.0	7.750	6.570	0.000	0.430
SHEETMETAL WORKER		BLD		35.450	37.380	1.5	1.5	2.0	5.250	14.77	0.520	0.290
SPRINKLER FITTER		BLD		36.140	38.890	1.5	1.5	2.0	8.100	8.200	0.000	0.350
STONE MASON		BLD		35.710	38.460	1.5	1.5	2.0	7.400	11.73	0.000	0.570
TERRAZZO FINISHER		BLD		32.240	0.000	1.5	1.5	2.0	7.400	4.840	0.000	0.500
TERRAZZO MASON		BLD		35.090	35.340	1.5	1.5	2.0	7.400	6.980	0.000	0.540
TILE LAYER		BLD		27.040	29.040	1.5	1.5	2.0	7.000	8.540	0.000	0.450
TILE MASON		BLD		35.090	35.340	1.5	1.5	2.0	7.400	6.980	0.000	0.540
TRUCK DRIVER		O&C	1	24.280	0.000	1.5	1.5	2.0	10.05	4.610	0.000	0.250
TRUCK DRIVER		O&C	2	24.630	0.000	1.5	1.5	2.0	10.05	4.610	0.000	0.250

TRUCK DRIVER	O&C	3	24.790	0.000	1.5	1.5	2.0	10.05	4.610	0.000	0.250
TRUCK DRIVER	O&C	4	25.020	0.000	1.5	1.5	2.0	10.05	4.610	0.000	0.250
TRUCK DRIVER	O&C	5	25.670	0.000	1.5	1.5	2.0	10.05	4.610	0.000	0.250
TRUCK DRIVER	E ALL	1	32.960	33.420	1.5	1.5	2.0	6.900	8.220	0.000	0.000
TRUCK DRIVER	E ALL	2	33.110	33.420	1.5	1.5	2.0	6.900	8.220	0.000	0.000
TRUCK DRIVER	E ALL	3	33.310	33.420	1.5	1.5	2.0	6.900	8.220	0.000	0.000
TRUCK DRIVER	E ALL	4	33.420	33.420	1.5	1.5	2.0	6.900	8.220	0.000	0.000
TRUCK DRIVER	W ALL	1	30.350	0.000	1.5	1.5	2.0	10.05	4.610	0.000	0.250
TRUCK DRIVER	W ALL	2	30.790	0.000	1.5	1.5	2.0	10.05	4.610	0.000	0.250
TRUCK DRIVER	W ALL	3	30.990	0.000	1.5	1.5	2.0	10.05	4.610	0.000	0.250
TRUCK DRIVER	W ALL	4	31.270	0.000	1.5	1.5	2.0	10.05	4.610	0.000	0.250
TRUCK DRIVER	W ALL	5	32.090	0.000	1.5	1.5	2.0	10.05	4.610	0.000	0.250
TUCKPOINTER	BLD		35.710	38.460	1.5	1.5	2.0	7.400	11.73	0.000	0.570

Legend:

M-F>8 (Overtime is required for any hour greater than 8 worked each day, Monday through Friday.)

OSA (Overtime is required for every hour worked on Saturday)

OSH (Overtime is required for every hour worked on Sunday and Holidays)

H/W (Health & Welfare Insurance)

Pensn (Pension)

Vac (Vacation)

Trng (Training)

Explanations

JO DAVIESS COUNTY

ELECTRICIANS (EAST) - Townships of Warren, Rush, Nora, Stockton, Wards Grove, Pleasant Valley and Berrenman.

IRONWORKERS (EAST) - That part of the county East of a North-South line from the North county line through Elizabeth, and East of a diagonal line from Elizabeth through Derinda Center to the South county line.

TRUCK DRIVERS (WEST) - That part of the county West of Rt. 78 including Stockton.

The following list is considered as those days for which holiday rates of wages for work performed apply: New Years Day, Memorial Day, Fourth of July, Labor Day, Thanksgiving Day, Christmas Day and Veterans Day in some classifications/counties. Generally, any of these holidays which fall on a Sunday is celebrated on the following Monday. This then makes work performed on that Monday payable at the appropriate overtime rate for holiday pay. Common practice in a given local may alter certain days of celebration. If in doubt, please check with IDOL.

Oil and chip resealing (O&C) means the application of road oils and liquid asphalt to coat an existing road surface, followed by application of aggregate chips or gravel to coated surface, and subsequent rolling of material to seal the surface.

EXPLANATION OF CLASSES

ASBESTOS - GENERAL - removal of asbestos material/mold and hazardous materials from any place in a building, including mechanical systems where those mechanical systems are to be removed. This includes the removal of asbestos materials/mold and hazardous materials from ductwork or pipes in a building when the building is to be demolished at the time or at some close future date.

ASBESTOS - MECHANICAL - removal of asbestos material from mechanical systems, such as pipes, ducts, and boilers, where the mechanical systems are to remain.

CERAMIC TILE FINISHER, MARBLE FINISHER, TERRAZZO FINISHER

Assisting, helping or supporting the tile, marble and terrazzo mechanic by performing their historic and traditional work assignments required to complete the proper installation of the work covered by said crafts. The term "Ceramic" is used for naming the classification only and is in no way a limitation of the product handled. Ceramic takes into consideration most hard tiles.

COMMUNICATIONS TECHNICIAN

Installing, manufacturing, assembling and maintaining sound and intercom, protection alarm (security), fire alarm, master antenna television, closed circuit television, low voltage control for computers and/or door monitoring, school communications systems, telephones and servicing of nurse and emergency calls, and the installation and maintenance of transmit and receive antennas, transmitters, receivers, and associated apparatus which operates in conjunction with above systems. All work associated with these system installations will be included EXCEPT the installation of protective metallic conduit in new construction projects (excluding less than ten-foot runs strictly for protection of cable) and 120 volt AC (or higher) power wiring and associated hardware.

LABORER, SKILLED - HIGHWAY

Individuals engaged in the following types of work, irrespective of the site of the work: asbestos abatement worker, handling of any materials with any foreign matter harmful to skin or clothing, track laborer, cement handlers, chloride handlers, the unloading and loading with steel workers and re-bars, concrete workers wet, tunnel helpers in free air, batch dumpers, mason tenders, kettle and tar men, tank cleaners, plastic installers, scaffold workers, motorized buggies or motorized unit used for wet concrete or handling of building materials, laborers with de-watering systems, sewer workers plus depth, rod and chainmen with technical engineers, rod and chainmen with land surveyors, rod and chainmen with surveyors, vibrator operators, cement silica, clay, fly ash, lime and plasters, handlers (bulk or bag), cofferdam workers plus depth, on concrete paving, placing, cutting and tying of reinforcing, deck hand, dredge hand, and shore laborers, bankmen on floating plant, grade checker, power tools, front end man on chip spreaders, cession workers plus depth, gunnite nozzle men, lead man on sewer work, welders, cutters, burners and torchmen, chainsaw operators, jackhammer and drill operators, layout man and/or drainage tile layer, steel form setter - street and highway, air tamping hammermen, signal man on crane, concrete saw operator, screedman on asphalt pavers, laborers tending masons with hot material or where foreign materials are used, mortar mixer operators, multiple concrete duct - leadsman, lumen, asphalt raker, curb asphalt machine operator, ready mix scalemen (permanent, portable

or temporary plant), laborers handling masterplate or similar materials, laser beam operator, concrete burning machine operator, coring machine operator, plaster tender, underpinning and shoring of buildings, pump men, manhole and catch basin, dirt and stone tamper, hose men on concrete pumps, hazardous waste worker, lead base paint abatement worker, lining of pipe, refusing machine, assisting on direct boring machine, the work of laying watermain, fire hydrants, all mechanical joints to watermain work, sewer worker, and tapping water service and forced lift station mechanical worker.

OPERATING ENGINEERS - BUILDING

Class 1. Asphalt Plant; Asphalt Spreader; Autograde; Backhoes with Caisson Attachment; Batch Plant; Benoto (requires Two Engineers); Boiler and Throttle Valve; Caisson Rigs; Central Redi-Mix Plant; Combination Back Hoe Front End-loader Machine; Compressor and Throttle Valve; Concrete Breaker (Truck Mounted); Concrete Conveyor; Concrete Paver (over 27E cu. ft.): Concrete Paver (27 cu. ft. and under); Concrete Placer; Concrete Pump (Truck Mounted); Concrete Conveyor (Truck Mounted); Concrete Tower; Cranes, All; GCI and similar types (required two operators only); Cranes, Hammerhead; Creter Crane; Crusher, Stone, etc.; Derricks, All; Derricks, Traveling; Formless Curb and Gutter Machine; Grader, Elevating; Grouting Machines; Highlift Shovels or Front Endloader 2-1/4 yd. and over; Hoists, Elevators, outside type rack and pinion and similar machines; Hoists, one, two and three Drum; Hoists, Two Tugger One Floor; Hydraulic Backhoes; Hydraulic Boom Trucks; Locomotives, All; Lubrication Technician; Manipulators; Motor Patrol; Pile Drivers and Skid Rig; Post Hole Digger; Pre-Stress Machine; Pump Cretes Dual Ram; Pump Cretes: Squeeze Cretes - Screw Type Pumps, Gypsum Bulker and Pump; Raised and Blind Hole Drill; Rock Drill (self-propelled); Rock Drill - Truck Mounted; Roto Mill Grinder; Scoops - Tractor Drawn; Slipform Paver; Scrapers Prime Movers; Straddle Buggies; Tie Back Machine; Tractor with Boom and Side Boom; Trenching Machines.

Class 2. Bobcat (over 3/4 cu. yd.); Boilers; Brick Forklift; Broom, All Power Propelled; Bulldozers; Concrete Mixer (Two Bag and Over); Conveyor, Portable; Forklift Trucks; Highlift Shovels or Front Endloaders under 2-1/4 yd.; Hoists, Automatic; Hoists, Sewer Dragging Machine; Hoists, Tugger Single Drum; Rollers, All; Steam Generators; Tractors, All; Tractor Drawn Vibratory Roller; Winch Trucks with "A" Frame.

Class 3. Air Compressor; Asphalt Spreader; Combination - Small Equipment Operator; Generators; Heaters, Mechanical; Hoists, Inside Elevators - (Rheostat Manual Controlled); Hydraulic Power Units (Pile Driving and Extracting); Pumps, Over 3" (1 to 3 not to exceed total of 300 ft.); Pumps, Well Points; Welding Machines (2 through 5); Winches, 4 Small Electric Drill Winches; Bobcat (up to and including 3/4 cu. yd.).

Class 4. Elevator push button with automatic doors; Hoists, Inside; Oilers; Brick Forklift.

Class 5. Assistant Craft Foreman

Class 6. Mechanics

Class 7. Gradall

OPERATING ENGINEERS - HIGHWAY CONSTRUCTION

Class 1. Asphalt Plant; Asphalt Heater and Planer Combination; Asphalt Heater Scarfire; Asphalt Silo Tender; Asphalt Spreader; Autograder; ABG Paver; Backhoes with Caisson Attachment; Ballast Regulator; Belt Loader; Caisson Rigs; Car Dumper; Central Redi-Mix Plant; Backhoe w/shear attachments; Combination Backhoe Front Endloader Machine, (1 cu. yd. Backhoe Bucket or over or with attachments); Concrete Breaker (Truck Mounted); Concrete Conveyor; Concrete Paver over 27E cu. ft.; Concrete Placer; Concrete Tube Float; Cranes, all attachments; Cranes, Tower of all types; Creter Crane; Crusher, Stone, etc.; Derricks, All; Derrick Boats; Derricks, Traveling; Directional Boring Machine over 12"; Dredges; Formless Curb and Gutter Machine; Grader, Elevating; Grader, Motor Grader, Motor Patrol, Auto Patrol, Form Grader, Pull Grader, Subgrader; Guard Rail Post Driver Mounted; Hoists, One, Two and Three Drum; Hydraulic Backhoes; Lubrication Technician; Manipulators; Pile Drivers and Skid Rig; Pre-Stress Machine; Pump Cretes Dual Ram; Rock Drill - Crawler or Skid Rig; Rock Drill - Truck Mounted; Rock/Track Tamper; Roto Mill Grinder; Slip-Form Paver; Soil Test Drill Rig (Truck Mounted); Straddle Buggies; GCI Crane; Hydraulic Telescoping Form (Tunnel); Tie Back Machine; Tractor Drawn Belt Loader; Tractor Drawn Belt Loader with attached pusher; Tractor with Boom; Tractaire with Attachments; Traffic Barrier Conveyor Machine; Raised or Blind Hole Drills; Trenching Machine (over 12"); Truck Mounted Concrete Pump with Boom; Truck Mounted Concrete Conveyor; Underground Boring and/or Mining Machines; Wheel Excavator; Widener (APSCO).

Class 2. Batch Plant; Bituminous Mixer; Boiler and Throttle Valve; Bulldozers; Car Loader Trailing Conveyors; Combination Backhoe Front Endloader Machine (less than 1 cu. yd. Backhoe Bucket or over or with attachments); Compressor and Throttle Valve; Compressor, Common Receiver (3); Concrete Breaker or Hydro Hammer; Concrete Grinding Machine; Concrete Mixer or Paver 7S Series to and including 27 cu. ft.; Concrete Spreader; Concrete Curing Machine, Burlap Machine, Belting Machine and Sealing Machine; Conveyor Muck Cars (Haglund or Similar Type); Drills, all; Finishing Machine - Concrete; Highlift Shovels or Front Endloader; Hoist - Sewer Dragging Machine; Hydraulic Boom Trucks (All Attachments); Hydro Blaster; All Locomotives, Dinky; Off-Road Hauling Units (including articulating) / 2 ton capacity or more; Non-Self Loading Ejection Dump; Pump Cretes: Squeeze Cretes - Screw Type Pumps, Gypsum Bulker and Pump; Roller, Asphalt; Rotary Snow Plows; Rototiller, Seaman, etc., self-propelled; Scoops - Tractor Drawn; Self-Propelled Compactor; Spreader - Chip - Stone, etc.; Scraper; Scraper - Prime Mover in Tandem (Regardless of Size); Tank Car Heater; Tractors, Push, Pulling Sheeps Foot, Disc, Compactor, etc.; Tug Boats.

Class 3. Boilers; Brooms, All Power Propelled; Cement Supply Tender; Compressor, Common Receiver (2); Concrete Mixer (Two Bag and Over); Conveyor, Portable; Farm-Type Tractors Used for Mowing, Seeding, etc.; Fireman on Boilers; Forklift Trucks; Grouting Machine; Hoists, Automatic; Hoists, All Elevators; Hoists, Tugger Single Drum; Jeep Diggers; Low Boys; Pipe Jacking Machines; Post-Hole Digger; Power Saw, Concrete Power Driven; Pug Mills; Rollers, other than asphalt; Seed and Straw Blower; Steam Generators; Stump Machine; Winch Trucks with "A" Frame; Work Boats; Tamper - Form - Motor Driven.

Class 4. Air Compressor - Small and Large; Asphalt Spreader, Backend Man; Bobcat (Skid Steer) all; Brick Forklift; Combination - Small Equipment Operator; Directional Boring Machine up to 12"; Generators; Heaters, Mechanical; Hydraulic Power Unit (Pile Driving, Extracting, or Drilling); Hydro-Blaster; Light Plants, All (1 through 5); Pumps, over 3" (1 to 3 not to exceed a total of 300 ft.); Pumps, Well Points; Tractaire; Trencher 12" and under; Welding Machines (2 through 5);

Winches, 4 Small Electric Drill Winches.

Class 5. Oilers and Directional Boring Machine Locator.

Class 6. Field Mechanics and Field Welders

Class 7. Gradall and machines of like nature.

TRUCK DRIVER - BUILDING, HEAVY AND HIGHWAY CONSTRUCTION - WEST

Class 1. Drivers on 2 axle trucks hauling less than 9 ton. Air compressor and welding machines and brooms, including those pulled by separate units, truck driver helpers, warehouse employees, mechanic helpers, greasers and tiremen, pickup trucks when hauling materials, tools, or workers to and from and on-the-job site, and fork lifts up to 6,000 lb. capacity.

Class 2. Two or three axle trucks hauling more than 9 ton but hauling less than 16 ton. A-frame winch trucks, hydrolift trucks, vector trucks or similar equipment when used for transportation purposes. Fork lifts over 6,000 lb. capacity, winch trucks, four axle combination units, and ticket writers.

Class 3. Two, three or four axle trucks hauling 16 ton or more. Drivers on water pulls, articulated dump trucks, mechanics and working forepersons, and dispatchers. Five axle or more combination units.

Class 4. Low Boy and Oil Distributors.

Class 5. Drivers who require special protective clothing while employed on hazardous waste work.

TRUCK DRIVER - BUILDING, HEAVY AND HIGHWAY CONSTRUCTION - EAST

Class 1. Two or three Axle Trucks. A-frame Truck when used for transportation purposes; Air Compressors and Welding Machines, including those pulled by cars, pick-up trucks and tractors; Ambulances; Batch Gate Lockers; Batch Hopperman; Car and Truck Washers; Carry-alls; Fork Lifts and Hoisters; Helpers; Mechanics Helpers and Greasers; Oil Distributors 2-man operation; Pavement Breakers; Pole Trailer, up to 40 feet; Power Mower Tractors; Self-propelled Chip Spreader; Skipman; Slurry Trucks, 2-man operation; Slurry Truck Conveyor Operation, 2 or 3 man; Teamsters; Unskilled dumpman; and Truck Drivers hauling warning lights, barricades, and portable toilets on the job site.

Class 2. Four axle trucks; Dump Crets and Adgetors under 7 yards; Dumpsters, Track Trucks, Euclids, Hug Bottom Dump Turnapulls or Turnatrailers when pulling other than self-loading equipment or similar equipment under 16 cubic yards; Mixer Trucks under 7 yards; Ready-mix Plant Hopper Operator, and Winch Trucks, 2 Axles.

Class 3. Five axle trucks; Dump Crets and Adgetors 7 yards and over; Dumpsters, Track Trucks, Euclids, Hug Bottom Dump Turnatrailers or turnapulls when pulling other than self-loading equipment or similar equipment over 16 cubic yards; Explosives and/or Fission Material Trucks; Mixer Trucks 7 yards or over; Mobile Cranes while in transit; Oil Distributors, 1-man operation; Pole Trailer, over 40 feet; Pole and Expandable Trailers hauling material over 50 feet long; Slurry trucks, 1-man operation; Winch trucks, 3 axles or more; Mechanic--Truck Welder and Truck Painter.

Class 4. Six axle trucks; Dual-purpose vehicles, such as mounted crane trucks with hoist and accessories; Foreman; Master Mechanic; Self-loading equipment like P.B. and trucks with scoops on the front.

TRUCK DRIVER - OIL AND CHIP RESEALING ONLY.

This shall encompass laborers, workers and mechanics who drive contractor or subcontractor owned, leased, or hired pickup, dump, service, or oil distributor trucks. The work includes transporting materials and equipment (including but not limited to, oils, aggregate supplies, parts, machinery and tools) to or from the job site; distributing oil or liquid asphalt and aggregate; stock piling material when in connection with the actual oil and chip contract. The Truck Driver (Oil & Chip Resealing) wage classification does not include supplier delivered materials.

Other Classifications of Work:

For definitions of classifications not otherwise set out, the Department generally has on file such definitions which are available. If a task to be performed is not subject to one of the classifications of pay set out, the Department will upon being contacted state which neighboring county has such a classification and provide such rate, such rate being deemed to exist by reference in this document. If no neighboring county rate applies to the task, the Department shall undertake a special determination, such special determination being then deemed to have existed under this determination. If a project requires these, or any classification not listed, please contact IDOL at 217-782-1710 for wage rates or clarifications.

LANDSCAPING

Landscaping work falls under the existing classifications for laborer, operating engineer and truck driver. The work performed by landscape plantsman and landscape laborer is covered by the existing classification of laborer. The work performed by landscape operators (regardless of equipment used or its size) is covered by the classifications of operating engineer. The work performed by landscape truck drivers (regardless of size of truck driven) is covered by the classifications of truck driver.

Lee County Prevailing Wage for February 2012

Trade Name	RG	TYP	C	Base	FRMAN	*M-F>8	OSA	OSH	H/W	Pensn	Vac	Trng
=====	==	===	=	=====	=====	=====	===	===	=====	=====	=====	=====
ASBESTOS ABT-GEN		BLD		29.400	30.400	1.5	1.5	2.0	8.040	12.02	0.000	0.800
ASBESTOS ABT-MEC		BLD		31.540	0.000	1.5	1.5	2.0	9.670	9.610	0.000	0.520
BOILERMAKER		BLD		34.170	37.170	2.0	2.0	2.0	6.820	8.550	0.000	0.350
BRICK MASON		BLD		35.710	38.460	1.5	1.5	2.0	7.400	11.73	0.000	0.570
CARPENTER		BLD		32.040	35.560	1.5	1.5	2.0	8.520	12.87	0.000	0.600
CARPENTER		HWY		32.440	34.190	1.5	1.5	2.0	9.250	11.99	0.000	0.490
CEMENT MASON		ALL		32.520	35.270	1.5	1.5	2.0	7.400	13.78	0.000	0.250
CERAMIC TILE FNSHER		BLD		32.240	0.000	1.5	1.5	2.0	7.400	4.840	0.000	0.500
COMMUNICATION TECH		BLD		36.000	39.600	1.5	1.5	2.0	9.740	11.20	0.000	0.720
ELECTRIC PWR EQMT OP		ALL		34.240	45.510	1.5	1.5	2.0	5.000	10.62	0.000	0.260
ELECTRIC PWR GRNDMAN		ALL		26.480	45.510	1.5	1.5	2.0	5.000	8.200	0.000	0.200
ELECTRIC PWR LINEMAN		ALL		41.000	45.510	1.5	1.5	2.0	5.000	12.71	0.000	0.310
ELECTRIC PWR TRK DRV		ALL		27.420	45.510	1.5	1.5	2.0	5.000	8.500	0.000	0.210
ELECTRICIAN		BLD		40.000	44.000	1.5	1.5	2.0	9.740	15.83	0.000	0.800
ELEVATOR CONSTRUCTOR		BLD		44.940	50.560	2.0	2.0	2.0	11.03	11.96	2.760	0.000
GLAZIER		BLD		29.520	31.520	1.5	1.5	2.0	8.950	7.700	0.000	1.250
HT/FROST INSULATOR		BLD		43.800	46.300	1.5	1.5	2.0	10.82	11.86	0.000	0.720
IRON WORKER	N	ALL		35.000	36.750	2.0	2.0	2.0	8.000	19.59	0.000	0.950
IRON WORKER	S	ALL		37.000	38.000	2.0	2.0	2.0	8.890	18.20	0.000	0.700
LABORER		BLD		29.400	30.400	1.5	1.5	2.0	8.040	12.02	0.000	0.800
LABORER		HWY		30.100	30.850	1.5	1.5	2.0	8.040	12.02	0.000	0.800
LABORER, SKILLED		HWY		32.250	33.000	1.5	1.5	2.0	8.040	12.02	0.000	0.800
LATHER		BLD		32.040	35.560	1.5	1.5	2.0	8.520	12.87	0.000	0.600
MACHINIST		BLD		43.160	45.160	1.5	1.5	2.0	7.980	8.950	0.000	0.000
MARBLE FINISHERS		BLD		32.240	0.000	1.5	1.5	2.0	7.400	4.840	0.000	0.500
MARBLE MASON		BLD		35.090	35.340	1.5	1.5	2.0	7.400	6.980	0.000	0.540
MATERIAL TESTER I		ALL		21.550	0.000	1.5	1.5	2.0	7.460	4.840	0.000	0.170
MATERIALS TESTER II		ALL		26.550	0.000	1.5	1.5	2.0	7.460	4.840	0.000	0.170
MILLWRIGHT		BLD		34.400	37.840	1.5	1.5	2.0	7.100	11.94	0.000	0.500
OPERATING ENGINEER		BLD	1	40.350	44.350	2.0	2.0	2.0	14.55	9.300	2.350	1.300
OPERATING ENGINEER		BLD	2	39.650	44.350	2.0	2.0	2.0	14.55	9.300	2.350	1.300
OPERATING ENGINEER		BLD	3	37.200	44.350	2.0	2.0	2.0	14.55	9.300	2.350	1.300
OPERATING ENGINEER		BLD	4	35.200	44.350	2.0	2.0	2.0	14.55	9.300	2.350	1.300
OPERATING ENGINEER		BLD	5	44.100	44.350	2.0	2.0	2.0	14.55	9.300	2.350	1.300
OPERATING ENGINEER		BLD	6	43.350	44.350	2.0	2.0	2.0	14.55	9.300	2.350	1.300
OPERATING ENGINEER		BLD	7	40.350	44.350	2.0	2.0	2.0	14.55	9.300	2.350	1.300
OPERATING ENGINEER		HWY	1	40.200	44.200	1.5	1.5	2.0	14.55	9.300	2.350	1.300
OPERATING ENGINEER		HWY	2	39.650	44.200	1.5	1.5	2.0	14.55	9.300	2.350	1.300
OPERATING ENGINEER		HWY	3	38.350	44.200	1.5	1.5	2.0	14.55	9.300	2.350	1.300
OPERATING ENGINEER		HWY	4	36.900	44.200	1.5	1.5	2.0	14.55	9.300	2.350	1.300
OPERATING ENGINEER		HWY	5	35.450	44.200	1.5	1.5	2.0	14.55	9.300	2.350	1.300
OPERATING ENGINEER		HWY	6	43.200	44.200	1.5	1.5	2.0	14.55	9.300	2.350	1.300
OPERATING ENGINEER		HWY	7	41.200	44.200	1.5	1.5	2.0	14.55	9.300	2.350	1.300
PAINTER		ALL		35.000	37.000	1.5	1.5	1.5	8.950	8.200	0.000	1.250
PILEDRIVER		BLD		33.040	36.670	1.5	1.5	2.0	8.520	12.87	0.000	0.600
PILEDRIVER		HWY		32.440	34.190	1.5	1.5	2.0	9.250	11.99	0.000	0.490
PIPEFITTER		ALL		35.700	39.270	1.5	1.5	2.0	5.150	11.35	0.000	1.000
PLASTERER		BLD		33.360	36.700	2.0	2.0	2.0	7.650	11.05	0.000	0.250
PLUMBER		ALL		35.700	39.270	1.5	1.5	2.0	5.150	11.35	0.000	1.000
ROOFER		BLD		37.650	40.650	1.5	1.5	2.0	7.750	6.570	0.000	0.430
SHEETMETAL WORKER		BLD		35.450	37.380	1.5	1.5	2.0	5.250	14.77	0.520	0.290
SPRINKLER FITTER		BLD		36.140	38.890	1.5	1.5	2.0	8.100	8.200	0.000	0.350
STONE MASON		BLD		35.710	38.460	1.5	1.5	2.0	7.400	11.73	0.000	0.570
TERRAZZO FINISHER		BLD		32.240	0.000	1.5	1.5	2.0	7.400	4.840	0.000	0.500
TERRAZZO MASON		BLD		35.090	35.340	1.5	1.5	2.0	7.400	6.980	0.000	0.540
TILE LAYER		BLD		32.040	35.560	1.5	1.5	2.0	8.520	12.87	0.000	0.600
TILE MASON		BLD		35.090	35.340	1.5	1.5	2.0	7.400	6.980	0.000	0.540
TRUCK DRIVER		O&C	1	24.280	0.000	1.5	1.5	2.0	10.05	4.610	0.000	0.250

TRUCK DRIVER	O&C	2	24.630	0.000	1.5	1.5	2.0	10.05	4.610	0.000	0.250	
TRUCK DRIVER	O&C	3	24.790	0.000	1.5	1.5	2.0	10.05	4.610	0.000	0.250	
TRUCK DRIVER	O&C	4	25.020	0.000	1.5	1.5	2.0	10.05	4.610	0.000	0.250	
TRUCK DRIVER	O&C	5	25.670	0.000	1.5	1.5	2.0	10.05	4.610	0.000	0.250	
TRUCK DRIVER	E	ALL	1	32.550	33.100	1.5	1.5	2.0	6.500	4.350	0.000	0.000
TRUCK DRIVER	E	ALL	2	32.700	33.100	1.5	1.5	2.0	6.500	4.350	0.000	0.000
TRUCK DRIVER	E	ALL	3	32.900	33.100	1.5	1.5	2.0	6.500	4.350	0.000	0.000
TRUCK DRIVER	E	ALL	4	33.100	33.100	1.5	1.5	2.0	6.500	4.350	0.000	0.000
TRUCK DRIVER	W	ALL	1	30.350	0.000	1.5	1.5	2.0	10.05	4.610	0.000	0.250
TRUCK DRIVER	W	ALL	2	30.790	0.000	1.5	1.5	2.0	10.05	4.610	0.000	0.250
TRUCK DRIVER	W	ALL	3	30.990	0.000	1.5	1.5	2.0	10.05	4.610	0.000	0.250
TRUCK DRIVER	W	ALL	4	31.270	0.000	1.5	1.5	2.0	10.05	4.610	0.000	0.250
TRUCK DRIVER	W	ALL	5	32.090	0.000	1.5	1.5	2.0	10.05	4.610	0.000	0.250
TUCKPOINTER	BLD		35.710	38.460	1.5	1.5	2.0	7.400	11.73	0.000	0.570	

Legend:

M-F>8 (Overtime is required for any hour greater than 8 worked each day, Monday through Friday.)

OSA (Overtime is required for every hour worked on Saturday)

OSH (Overtime is required for every hour worked on Sunday and Holidays)

H/W (Health & Welfare Insurance)

Pensn (Pension)

Vac (Vacation)

Trng (Training)

Explanations

LEE COUNTY

IRONWORKERS (SOUTH) - That part of the county South of Route 30.

TRUCK DRIVERS (EAST) - That part of the county East of U.S. 251 and North of Route 30.

The following list is considered as those days for which holiday rates of wages for work performed apply: New Years Day, Memorial Day, Fourth of July, Labor Day, Thanksgiving Day, Christmas Day and Veterans Day in some classifications/counties. Generally, any of these holidays which fall on a Sunday is celebrated on the following Monday. This then makes work performed on that Monday payable at the appropriate overtime rate for holiday pay. Common practice in a given local may alter certain days of celebration. If in doubt, please check with IDOL.

Oil and chip resealing (O&C) means the application of road oils and liquid asphalt to coat an existing road surface, followed by application of aggregate chips or gravel to coated surface, and subsequent rolling of material to seal the surface.

EXPLANATION OF CLASSES

ASBESTOS - GENERAL - removal of asbestos material/mold and hazardous materials from any place in a building, including mechanical systems

where those mechanical systems are to be removed. This includes the removal of asbestos materials/mold and hazardous materials from ductwork or pipes in a building when the building is to be demolished at the time or at some close future date.

ASBESTOS - MECHANICAL - removal of asbestos material from mechanical systems, such as pipes, ducts, and boilers, where the mechanical systems are to remain.

CERAMIC TILE FINISHER, MARBLE FINISHER, TERRAZZO FINISHER

Assisting, helping or supporting the tile, marble and terrazzo mechanic by performing their historic and traditional work assignments required to complete the proper installation of the work covered by said crafts. The term "Ceramic" is used for naming the classification only and is in no way a limitation of the product handled. Ceramic takes into consideration most hard tiles.

COMMUNICATIONS TECHNICIAN

Installing, manufacturing, assembling and maintaining sound and intercom, protection alarm (security), fire alarm, master antenna television, closed circuit television, low voltage control for computers and/or door monitoring, school communications systems, telephones and servicing of nurse and emergency calls, and the installation and maintenance of transmit and receive antennas, transmitters, receivers, and associated apparatus which operates in conjunction with above systems. All work associated with these system installations will be included EXCEPT the installation of protective metallic conduit in new construction projects (excluding less than ten-foot runs strictly for protection of cable) and 120 volt AC (or higher) power wiring and associated hardware.

LABORER, SKILLED - HIGHWAY

Individuals engaged in the following types of work, irrespective of the site of the work: asbestos abatement worker, handling of any materials with any foreign matter harmful to skin or clothing, track laborer, cement handlers, chloride handlers, the unloading and loading with steel workers and re-bars, concrete workers wet, tunnel helpers in free air, batch dumpers, mason tenders, kettle and tar men, tank cleaners, plastic installers, scaffold workers, motorized buggies or motorized unit used for wet concrete or handling of building materials, laborers with de-watering systems, sewer workers plus depth, rod and chainmen with technical engineers, rod and chainmen with land surveyors, rod and chainmen with surveyors, vibrator operators, cement silica, clay, fly ash, lime and plasters, handlers (bulk or bag), cofferdam workers plus depth, on concrete paving, placing, cutting and tying of reinforcing, deck hand, dredge hand, and shore laborers, bankmen on floating plant, grade checker, power tools, front end man on chip spreaders, cession workers plus depth, gunnite nozzle men, lead man on sewer work, welders, cutters, burners and torchmen, chainsaw operators, jackhammer and drill operators, layout man and/or drainage tile layer, steel form setter - street and highway, air tamping hammermen, signal man on crane, concrete saw operator, screedman on asphalt pavers, laborers tending masons with hot material or where foreign materials are used, mortar mixer operators, multiple concrete duct - leadsman, lumen, asphalt raker, curb asphalt machine operator, ready mix scalemen (permanent, portable or temporary plant), laborers handling masterplate or similar materials, laser beam operator, concrete burning machine operator, coring machine operator, plaster tender, underpinning and shoring of buildings, pump men, manhole and catch basin, dirt and stone tamper, hose men on concrete pumps, hazardous waste worker, lead base paint

abatement worker, lining of pipe, refusing machine, assisting on direct boring machine, the work of laying watermain, fire hydrants, all mechanical joints to watermain work, sewer worker, and tapping water service and forced lift station mechanical worker.

MATERIAL TESTER I: Hand coring and drilling for testing of materials; field inspection of uncured concrete and asphalt.

MATERIAL TESTER II: Field inspection of welds, structural steel, fireproofing, masonry, soil, facade, reinforcing steel, formwork, cured concrete, and concrete and asphalt batch plants; adjusting proportions of bituminous mixtures.

OPERATING ENGINEERS - BUILDING

Class 1. Asphalt Plant; Asphalt Spreader; Autograde; Backhoes with Caisson Attachment; Batch Plant; Benoto (requires Two Engineers); Boiler and Throttle Valve; Caisson Rigs; Central Redi-Mix Plant; Combination Back Hoe Front End-loader Machine; Compressor and Throttle Valve; Concrete Breaker (Truck Mounted); Concrete Conveyor; Concrete Paver (over 27E cu. ft.): Concrete Paver (27 cu. ft. and under); Concrete Placer; Concrete Pump (Truck Mounted); Concrete Conveyor (Truck Mounted); Concrete Tower; Cranes, All; GCI and similar types (required two operators only); Cranes, Hammerhead; Creter Crane; Crusher, Stone, etc.; Derricks, All; Derricks, Traveling; Formless Curb and Gutter Machine; Grader, Elevating; Grouting Machines; Highlift Shovels or Front Endloader 2-1/4 yd. and over; Hoists, Elevators, outside type rack and pinion and similar machines; Hoists, one, two and three Drum; Hoists, Two Tugger One Floor; Hydraulic Backhoes; Hydraulic Boom Trucks; Locomotives, All; Lubrication Technician; Manipulators; Motor Patrol; Pile Drivers and Skid Rig; Post Hole Digger; Pre-Stress Machine; Pump Cretes Dual Ram; Pump Cretes: Squeeze Cretes - Screw Type Pumps, Gypsum Bulker and Pump; Raised and Blind Hole Drill; Rock Drill (self-propelled); Rock Drill - Truck Mounted; Roto Mill Grinder; Scoops - Tractor Drawn; Slipform Paver; Scrapers Prime Movers; Straddle Buggies; Tie Back Machine; Tractor with Boom and Side Boom; Trenching Machines.

Class 2. Bobcat (over 3/4 cu. yd.); Boilers; Brick Forklift; Broom, All Power Propelled; Bulldozers; Concrete Mixer (Two Bag and Over); Conveyor, Portable; Forklift Trucks; Highlift Shovels or Front Endloaders under 2-1/4 yd.; Hoists, Automatic; Hoists, Sewer Dragging Machine; Hoists, Tugger Single Drum; Rollers, All; Steam Generators; Tractors, All; Tractor Drawn Vibratory Roller; Winch Trucks with "A" Frame.

Class 3. Air Compressor; Asphalt Spreader; Combination - Small Equipment Operator; Generators; Heaters, Mechanical; Hoists, Inside Elevators - (Rheostat Manual Controlled); Hydraulic Power Units (Pile Driving and Extracting); Pumps, Over 3" (1 to 3 not to exceed total of 300 ft.); Pumps, Well Points; Welding Machines (2 through 5); Winches, 4 Small Electric Drill Winches; Bobcat (up to and including 3/4 cu. yd.).

Class 4. Elevator push button with automatic doors; Hoists, Inside; Oilers; Brick Forklift.

Class 5. Assistant Craft Foreman

Class 6. Mechanics

Class 7. Gradall

OPERATING ENGINEERS - HIGHWAY CONSTRUCTION

Class 1. Asphalt Plant; Asphalt Heater and Planer Combination; Asphalt Heater Scarfire; Asphalt Silo Tender; Asphalt Spreader; Autograder; ABG Paver; Backhoes with Caisson Attachment; Ballast Regulator; Belt Loader; Caisson Rigs; Car Dumper; Central Redi-Mix Plant; Backhoe w/shear attachments; Combination Backhoe Front Endloader Machine, (1 cu. yd. Backhoe Bucket or over or with attachments); Concrete Breaker (Truck Mounted); Concrete Conveyor; Concrete Paver over 27E cu. ft.; Concrete Placer; Concrete Tube Float; Cranes, all attachments; Cranes, Tower of all types; Creter Crane; Crusher, Stone, etc.; Derricks, All; Derrick Boats; Derricks, Traveling; Directional Boring Machine over 12"; Dredges; Formless Curb and Gutter Machine; Grader, Elevating; Grader, Motor Grader, Motor Patrol, Auto Patrol, Form Grader, Pull Grader, Subgrader; Guard Rail Post Driver Mounted; Hoists, One, Two and Three Drum; Hydraulic Backhoes; Lubrication Technician; Manipulators; Pile Drivers and Skid Rig; Pre-Stress Machine; Pump Cretes Dual Ram; Rock Drill - Crawler or Skid Rig; Rock Drill - Truck Mounted; Rock/Track Tamper; Roto Mill Grinder; Slip-Form Paver; Soil Test Drill Rig (Truck Mounted); Straddle Buggies; GCI Crane; Hydraulic Telescoping Form (Tunnel); Tie Back Machine; Tractor Drawn Belt Loader; Tractor Drawn Belt Loader with attached pusher; Tractor with Boom; Tractaire with Attachments; Traffic Barrier Conveyor Machine; Raised or Blind Hole Drills; Trenching Machine (over 12"); Truck Mounted Concrete Pump with Boom; Truck Mounted Concrete Conveyor; Underground Boring and/or Mining Machines; Wheel Excavator; Widener (APSCO).

Class 2. Batch Plant; Bituminous Mixer; Boiler and Throttle Valve; Bulldozers; Car Loader Trailing Conveyors; Combination Backhoe Front Endloader Machine (less than 1 cu. yd. Backhoe Bucket or over or with attachments); Compressor and Throttle Valve; Compressor, Common Receiver (3); Concrete Breaker or Hydro Hammer; Concrete Grinding Machine; Concrete Mixer or Paver 7S Series to and including 27 cu. ft.; Concrete Spreader; Concrete Curing Machine, Burlap Machine, Belting Machine and Sealing Machine; Conveyor Muck Cars (Haglund or Similar Type); Drills, all; Finishing Machine - Concrete; Highlift Shovels or Front Endloader; Hoist - Sewer Dragging Machine; Hydraulic Boom Trucks (All Attachments); Hydro Blaster; All Locomotives, Dinky; Off-Road Hauling Units (including articulating) / 2 ton capacity or more; Non-Self Loading Ejection Dump; Pump Cretes: Squeeze Cretes - Screw Type Pumps, Gypsum Bulker and Pump; Roller, Asphalt; Rotary Snow Plows; Rototiller, Seaman, etc., self-propelled; Scoops - Tractor Drawn; Self-Propelled Compactor; Spreader - Chip - Stone, etc.; Scraper; Scraper - Prime Mover in Tandem (Regardless of Size); Tank Car Heater; Tractors, Push, Pulling Sheeps Foot, Disc, Compactor, etc.; Tug Boats.

Class 3. Boilers; Brooms, All Power Propelled; Cement Supply Tender; Compressor, Common Receiver (2); Concrete Mixer (Two Bag and Over); Conveyor, Portable; Farm-Type Tractors Used for Mowing, Seeding, etc.; Fireman on Boilers; Forklift Trucks; Grouting Machine; Hoists, Automatic; Hoists, All Elevators; Hoists, Tugger Single Drum; Jeep Diggers; Low Boys; Pipe Jacking Machines; Post-Hole Digger; Power Saw, Concrete Power Driven; Pug Mills; Rollers, other than asphalt; Seed and Straw Blower; Steam Generators; Stump Machine; Winch Trucks with "A" Frame; Work Boats; Tamper - Form - Motor Driven.

Class 4. Air Compressor - Small and Large; Asphalt Spreader, Backend Man; Bobcat (Skid Steer) all; Brick Forklift; Combination - Small Equipment Operator; Directional Boring Machine up to 12"; Generators; Heaters, Mechanical; Hydraulic Power Unit (Pile Driving, Extracting,

or Drilling); Hydro-Blaster; Light Plants, All (1 through 5); Pumps, over 3" (1 to 3 not to exceed a total of 300 ft.); Pumps, Well Points; Tractaire; Trencher 12" and under; Welding Machines (2 through 5); Winches, 4 Small Electric Drill Winches.

Class 5. Oilers and Directional Boring Machine Locator.

Class 6. Field Mechanics and Field Welders

Class 7. Gradall and machines of like nature.

TRUCK DRIVER - BUILDING, HEAVY AND HIGHWAY CONSTRUCTION - WEST

Class 1. Drivers on 2 axle trucks hauling less than 9 ton. Air compressor and welding machines and brooms, including those pulled by separate units, truck driver helpers, warehouse employees, mechanic helpers, greasers and tiremen, pickup trucks when hauling materials, tools, or workers to and from and on-the-job site, and fork lifts up to 6,000 lb. capacity.

Class 2. Two or three axle trucks hauling more than 9 ton but hauling less than 16 ton. A-frame winch trucks, hydrolift trucks, vector trucks or similar equipment when used for transportation purposes. Fork lifts over 6,000 lb. capacity, winch trucks, four axle combination units, and ticket writers.

Class 3. Two, three or four axle trucks hauling 16 ton or more. Drivers on water pulls, articulated dump trucks, mechanics and working forepersons, and dispatchers. Five axle or more combination units.

Class 4. Low Boy and Oil Distributors.

Class 5. Drivers who require special protective clothing while employed on hazardous waste work.

TRUCK DRIVER - BUILDING, HEAVY AND HIGHWAY CONSTRUCTION - EAST

Class 1. Two or three Axle Trucks. A-frame Truck when used for transportation purposes; Air Compressors and Welding Machines, including those pulled by cars, pick-up trucks and tractors; Ambulances; Batch Gate Lockers; Batch Hopperman; Car and Truck Washers; Carry-alls; Fork Lifts and Hoisters; Helpers; Mechanics Helpers and Greasers; Oil Distributors 2-man operation; Pavement Breakers; Pole Trailer, up to 40 feet; Power Mower Tractors; Self-propelled Chip Spreader; Skipman; Slurry Trucks, 2-man operation; Slurry Truck Conveyor Operation, 2 or 3 man; Teamsters; Unskilled dumpman; and Truck Drivers hauling warning lights, barricades, and portable toilets on the job site.

Class 2. Four axle trucks; Dump Crets and Adgetors under 7 yards; Dumpsters, Track Trucks, Euclids, Hug Bottom Dump Turnapulls or Turnatrailers when pulling other than self-loading equipment or similar equipment under 16 cubic yards; Mixer Trucks under 7 yards; Ready-mix Plant Hopper Operator, and Winch Trucks, 2 Axles.

Class 3. Five axle trucks; Dump Crets and Adgetors 7 yards and over; Dumpsters, Track Trucks, Euclids, Hug Bottom Dump Turnatrailers or turnapulls when pulling other than self-loading equipment or similar equipment over 16 cubic yards; Explosives and/or Fission Material Trucks; Mixer Trucks 7 yards or over; Mobile Cranes while in transit; Oil Distributors, 1-man operation; Pole Trailer, over 40 feet; Pole and Expandable Trailers hauling material over 50 feet long; Slurry

trucks, 1-man operation; Winch trucks, 3 axles or more;
Mechanic--Truck Welder and Truck Painter.

Class 4. Six axle trucks; Dual-purpose vehicles, such as mounted crane trucks with hoist and accessories; Foreman; Master Mechanic; Self-loading equipment like P.B. and trucks with scoops on the front.

TRUCK DRIVER - OIL AND CHIP RESEALING ONLY.

This shall encompass laborers, workers and mechanics who drive contractor or subcontractor owned, leased, or hired pickup, dump, service, or oil distributor trucks. The work includes transporting materials and equipment (including but not limited to, oils, aggregate supplies, parts, machinery and tools) to or from the job site; distributing oil or liquid asphalt and aggregate; stock piling material when in connection with the actual oil and chip contract. The Truck Driver (Oil & Chip Resealing) wage classification does not include supplier delivered materials.

Other Classifications of Work:

For definitions of classifications not otherwise set out, the Department generally has on file such definitions which are available. If a task to be performed is not subject to one of the classifications of pay set out, the Department will upon being contacted state which neighboring county has such a classification and provide such rate, such rate being deemed to exist by reference in this document. If no neighboring county rate applies to the task, the Department shall undertake a special determination, such special determination being then deemed to have existed under this determination. If a project requires these, or any classification not listed, please contact IDOL at 217-782-1710 for wage rates or clarifications.

LANDSCAPING

Landscaping work falls under the existing classifications for laborer, operating engineer and truck driver. The work performed by landscape plantsman and landscape laborer is covered by the existing classification of laborer. The work performed by landscape operators (regardless of equipment used or its size) is covered by the classifications of operating engineer. The work performed by landscape truck drivers (regardless of size of truck driven) is covered by the classifications of truck driver.

Ogle County Prevailing Wage for February 2012

Trade Name	RG	TYP	C	Base	FRMAN	*M-F>8	OSA	OSH	H/W	Pensn	Vac	Trng
=====	==	===	=	=====	=====	=====	===	===	=====	=====	=====	=====
ASBESTOS ABT-GEN		BLD		29.400	30.400	1.5	1.5	2.0	8.040	12.02	0.000	0.800
ASBESTOS ABT-MEC		BLD		18.950	0.000	1.5	1.5	2.0	2.700	3.350	0.000	0.000
BOILERMAKER		BLD		34.170	37.170	2.0	2.0	2.0	6.820	8.550	0.000	0.350
BRICK MASON		BLD		35.710	38.460	1.5	1.5	2.0	7.400	11.73	0.000	0.570
CARPENTER		HWY		32.440	34.190	1.5	1.5	2.0	9.250	11.99	0.000	0.490
CARPENTER	N	BLD		36.320	40.320	1.5	1.5	2.0	7.400	10.95	0.000	0.600
CARPENTER	S	BLD		32.040	35.560	1.5	1.5	2.0	8.520	12.87	0.000	0.600
CEMENT MASON		ALL		32.520	35.270	1.5	1.5	2.0	7.400	13.78	0.000	0.250
CERAMIC TILE FNSHER		BLD		32.240	0.000	1.5	1.5	2.0	7.400	4.840	0.000	0.500
COMMUNICATION TECH		BLD		36.000	39.600	1.5	1.5	2.0	9.740	11.20	0.000	0.720
ELECTRIC PWR EQMT OP		ALL		34.240	45.510	1.5	1.5	2.0	5.000	10.62	0.000	0.260
ELECTRIC PWR GRNDMAN		ALL		26.480	45.510	1.5	1.5	2.0	5.000	8.200	0.000	0.200
ELECTRIC PWR LINEMAN		ALL		41.000	45.510	1.5	1.5	2.0	5.000	12.71	0.000	0.310
ELECTRIC PWR TRK DRV		ALL		27.420	45.510	1.5	1.5	2.0	5.000	8.500	0.000	0.210
ELECTRICIAN		BLD		40.000	44.000	1.5	1.5	2.0	9.740	15.83	0.000	0.800
ELEVATOR CONSTRUCTOR		BLD		44.940	50.560	2.0	2.0	2.0	11.03	11.96	2.760	0.000
GLAZIER		BLD		32.730	33.730	1.5	1.5	2.0	8.950	8.200	0.000	1.250
HT/FROST INSULATOR		BLD		33.280	35.770	1.5	1.5	2.0	7.450	14.32	0.000	0.000
IRON WORKER		ALL		35.000	36.750	2.0	2.0	2.0	8.000	19.59	0.000	0.950
LABORER		BLD		29.400	30.400	1.5	1.5	2.0	8.040	12.02	0.000	0.800
LABORER		HWY		30.100	30.850	1.5	1.5	2.0	8.040	12.02	0.000	0.800
LABORER, SKILLED		HWY		32.250	33.000	1.5	1.5	2.0	8.040	12.02	0.000	0.800
LATHER	N	BLD		36.320	40.320	1.5	1.5	2.0	7.400	10.95	0.000	0.600
LATHER	S	BLD		32.040	35.560	1.5	1.5	2.0	8.520	12.87	0.000	0.600
MACHINIST		BLD		43.160	45.160	1.5	1.5	2.0	7.980	8.950	0.000	0.000
MARBLE FINISHERS		BLD		32.240	0.000	1.5	1.5	2.0	7.400	4.840	0.000	0.500
MARBLE MASON		BLD		35.090	35.340	1.5	1.5	2.0	7.400	6.980	0.000	0.540
MATERIAL TESTER I		ALL		21.550	0.000	1.5	1.5	2.0	7.460	4.840	0.000	0.170
MATERIALS TESTER II		ALL		26.550	0.000	1.5	1.5	2.0	7.460	4.840	0.000	0.170
MILLWRIGHT		BLD		33.970	37.370	1.5	1.5	2.0	6.550	12.35	0.000	0.500
OPERATING ENGINEER		BLD	1	40.350	44.350	2.0	2.0	2.0	14.55	9.300	2.350	1.300
OPERATING ENGINEER		BLD	2	39.650	44.350	2.0	2.0	2.0	14.55	9.300	2.350	1.300
OPERATING ENGINEER		BLD	3	37.200	44.350	2.0	2.0	2.0	14.55	9.300	2.350	1.300
OPERATING ENGINEER		BLD	4	35.200	44.350	2.0	2.0	2.0	14.55	9.300	2.350	1.300
OPERATING ENGINEER		BLD	5	44.100	44.350	2.0	2.0	2.0	14.55	9.300	2.350	1.300
OPERATING ENGINEER		BLD	6	43.350	44.350	2.0	2.0	2.0	14.55	9.300	2.350	1.300
OPERATING ENGINEER		BLD	7	40.350	44.350	2.0	2.0	2.0	14.55	9.300	2.350	1.300
OPERATING ENGINEER		HWY	1	40.200	44.200	1.5	1.5	2.0	14.55	9.300	2.350	1.300
OPERATING ENGINEER		HWY	2	39.650	44.200	1.5	1.5	2.0	14.55	9.300	2.350	1.300
OPERATING ENGINEER		HWY	3	38.350	44.200	1.5	1.5	2.0	14.55	9.300	2.350	1.300
OPERATING ENGINEER		HWY	4	36.900	44.200	1.5	1.5	2.0	14.55	9.300	2.350	1.300
OPERATING ENGINEER		HWY	5	35.450	44.200	1.5	1.5	2.0	14.55	9.300	2.350	1.300
OPERATING ENGINEER		HWY	6	43.200	44.200	1.5	1.5	2.0	14.55	9.300	2.350	1.300
OPERATING ENGINEER		HWY	7	41.200	44.200	1.5	1.5	2.0	14.55	9.300	2.350	1.300
PAINTER		ALL		35.000	37.000	1.5	1.5	1.5	8.950	8.200	0.000	1.250
PILEDRIVER		HWY		32.440	34.190	1.5	1.5	2.0	9.250	11.99	0.000	0.490
PILEDRIVER	N	BLD		37.320	41.430	1.5	1.5	2.0	7.400	10.95	0.000	0.600
PILEDRIVER	S	BLD		33.040	36.670	1.5	1.5	2.0	8.520	12.87	0.000	0.600
PIPEFITTER		BLD		39.250	42.000	1.5	1.5	2.0	7.980	10.59	0.000	0.950
PLASTERER		BLD		33.360	36.700	2.0	2.0	2.0	7.650	11.05	0.000	0.250
PLUMBER		BLD		39.250	42.000	1.5	1.5	2.0	7.980	10.59	0.000	0.950
ROOFER		BLD		37.650	40.650	1.5	1.5	2.0	7.750	6.570	0.000	0.430
SHEETMETAL WORKER		BLD		35.450	37.380	1.5	1.5	2.0	5.250	14.77	0.520	0.290
SPRINKLER FITTER		BLD		36.140	38.890	1.5	1.5	2.0	8.100	8.200	0.000	0.350
STONE MASON		BLD		35.710	38.460	1.5	1.5	2.0	7.400	11.73	0.000	0.570
TERRAZZO FINISHER		BLD		32.240	0.000	1.5	1.5	2.0	7.400	4.840	0.000	0.500
TERRAZZO MASON		BLD		35.090	35.340	1.5	1.5	2.0	7.400	6.980	0.000	0.540
TILE LAYER	N	BLD		36.320	40.320	1.5	1.5	2.0	7.400	10.95	0.000	0.600

TILE LAYER	S	BLD	32.040	35.560	1.5	1.5	2.0	8.520	12.87	0.000	0.600
TILE MASON		BLD	35.090	35.340	1.5	1.5	2.0	7.400	6.980	0.000	0.540
TRUCK DRIVER		O&C 1	24.280	0.000	1.5	1.5	2.0	10.05	4.610	0.000	0.250
TRUCK DRIVER		O&C 2	24.630	0.000	1.5	1.5	2.0	10.05	4.610	0.000	0.250
TRUCK DRIVER		O&C 3	24.790	0.000	1.5	1.5	2.0	10.05	4.610	0.000	0.250
TRUCK DRIVER		O&C 4	25.020	0.000	1.5	1.5	2.0	10.05	4.610	0.000	0.250
TRUCK DRIVER		O&C 5	25.670	0.000	1.5	1.5	2.0	10.05	4.610	0.000	0.250
TRUCK DRIVER	E	ALL 1	32.550	33.100	1.5	1.5	2.0	6.500	4.350	0.000	0.000
TRUCK DRIVER	E	ALL 2	32.700	33.100	1.5	1.5	2.0	6.500	4.350	0.000	0.000
TRUCK DRIVER	E	ALL 3	32.900	33.100	1.5	1.5	2.0	6.500	4.350	0.000	0.000
TRUCK DRIVER	E	ALL 4	33.100	33.100	1.5	1.5	2.0	6.500	4.350	0.000	0.000
TRUCK DRIVER	N	ALL 1	32.960	33.420	1.5	1.5	2.0	6.900	8.220	0.000	0.000
TRUCK DRIVER	N	ALL 2	33.110	33.420	1.5	1.5	2.0	6.900	8.220	0.000	0.000
TRUCK DRIVER	N	ALL 3	33.310	33.420	1.5	1.5	2.0	6.900	8.220	0.000	0.000
TRUCK DRIVER	N	ALL 4	33.420	33.420	1.5	1.5	2.0	6.900	8.220	0.000	0.000
TRUCK DRIVER	S	ALL 1	30.350	0.000	1.5	1.5	2.0	10.05	4.610	0.000	0.250
TRUCK DRIVER	S	ALL 2	30.790	0.000	1.5	1.5	2.0	10.05	4.610	0.000	0.250
TRUCK DRIVER	S	ALL 3	30.990	0.000	1.5	1.5	2.0	10.05	4.610	0.000	0.250
TRUCK DRIVER	S	ALL 4	31.270	0.000	1.5	1.5	2.0	10.05	4.610	0.000	0.250
TRUCK DRIVER	S	ALL 5	32.090	0.000	1.5	1.5	2.0	10.05	4.610	0.000	0.250
TUCKPOINTER		BLD	35.710	38.460	1.5	1.5	2.0	7.400	11.73	0.000	0.570

Legend:

M-F>8 (Overtime is required for any hour greater than 8 worked each day, Monday through Friday.)

OSA (Overtime is required for every hour worked on Saturday)

OSH (Overtime is required for every hour worked on Sunday and Holidays)

H/W (Health & Welfare Insurance)

Pensn (Pension)

Vac (Vacation)

Trng (Training)

Explanations

OGLE COUNTY

CARPENTER, LATHER, MILLWRIGHT, PILEDRIIVER AND TILE LAYER (NORTH) - That part of Ogle County East from the Winnebago County western boundary and North of an imaginary line running east and west located 4 miles north of the City of Oregon.

TRUCK DRIVER (EAST) - That part of the county East of Rt. 251, including all portions of the city of Rochelle, and South of Rt. 72.

TRUCK DRIVER (SOUTH) - That part of the county West of Rt. 251 and South of Rt. 72.

TRUCK DRIVER (NORTH) - That part of the county North of Route 72.

The following list is considered as those days for which holiday rates of wages for work performed apply: New Years Day, Memorial Day, Fourth of July, Labor Day, Thanksgiving Day, Christmas Day and

Veterans Day in some classifications/counties. Generally, any of these holidays which fall on a Sunday is celebrated on the following Monday. This then makes work performed on that Monday payable at the appropriate overtime rate for holiday pay. Common practice in a given local may alter certain days of celebration. If in doubt, please check with IDOL.

Oil and chip resealing (O&C) means the application of road oils and liquid asphalt to coat an existing road surface, followed by application of aggregate chips or gravel to coated surface, and subsequent rolling of material to seal the surface.

EXPLANATION OF CLASSES

ASBESTOS - GENERAL - removal of asbestos material/mold and hazardous materials from any place in a building, including mechanical systems where those mechanical systems are to be removed. This includes the removal of asbestos materials/mold and hazardous materials from ductwork or pipes in a building when the building is to be demolished at the time or at some close future date.

ASBESTOS - MECHANICAL - removal of asbestos material from mechanical systems, such as pipes, ducts, and boilers, where the mechanical systems are to remain.

CERAMIC TILE FINISHER, MARBLE FINISHER, TERRAZZO FINISHER

Assisting, helping or supporting the tile, marble and terrazzo mechanic by performing their historic and traditional work assignments required to complete the proper installation of the work covered by said crafts. The term "Ceramic" is used for naming the classification only and is in no way a limitation of the product handled. Ceramic takes into consideration most hard tiles.

COMMUNICATIONS TECHNICIAN

Installing, manufacturing, assembling and maintaining sound and intercom, protection alarm (security), fire alarm, master antenna television, closed circuit television, low voltage control for computers and/or door monitoring, school communications systems, telephones and servicing of nurse and emergency calls, and the installation and maintenance of transmit and receive antennas, transmitters, receivers, and associated apparatus which operates in conjunction with above systems. All work associated with these system installations will be included EXCEPT the installation of protective metallic conduit in new construction projects (excluding less than ten-foot runs strictly for protection of cable) and 120 volt AC (or higher) power wiring and associated hardware.

LABORER, SKILLED - HIGHWAY

Individuals engaged in the following types of work, irrespective of the site of the work: asbestos abatement worker, handling of any materials with any foreign matter harmful to skin or clothing, track laborer, cement handlers, chloride handlers, the unloading and loading with steel workers and re-bars, concrete workers wet, tunnel helpers in free air, batch dumpers, mason tenders, kettle and tar men, tank cleaners, plastic installers, scaffold workers, motorized buggies or motorized unit used for wet concrete or handling of building materials, laborers with de-watering systems, sewer workers plus depth, rod and chainmen with technical engineers, rod and chainmen with land surveyors, rod and chainmen with surveyors, vibrator operators, cement silica, clay, fly ash, lime and plasters, handlers

(bulk or bag), cofferdam workers plus depth, on concrete paving, placing, cutting and tying of reinforcing, deck hand, dredge hand, and shore laborers, bankmen on floating plant, grade checker, power tools, front end man on chip spreaders, cession workers plus depth, gunnite nozzle men, lead man on sewer work, welders, cutters, burners and torchmen, chainsaw operators, jackhammer and drill operators, layout man and/or drainage tile layer, steel form setter - street and highway, air tamping hammermen, signal man on crane, concrete saw operator, screedman on asphalt pavers, laborers tending masons with hot material or where foreign materials are used, mortar mixer operators, multiple concrete duct - leadsman, lumen, asphalt raker, curb asphalt machine operator, ready mix scalemen (permanent, portable or temporary plant), laborers handling masterplate or similar materials, laser beam operator, concrete burning machine operator, coring machine operator, plaster tender, underpinning and shoring of buildings, pump men, manhole and catch basin, dirt and stone tamper, hose men on concrete pumps, hazardous waste worker, lead base paint abatement worker, lining of pipe, refusing machine, assisting on direct boring machine, the work of laying watermain, fire hydrants, all mechanical joints to watermain work, sewer worker, and tapping water service and forced lift station mechanical worker.

MATERIAL TESTER I: Hand coring and drilling for testing of materials; field inspection of uncured concrete and asphalt.

MATERIAL TESTER II: Field inspection of welds, structural steel, fireproofing, masonry, soil, facade, reinforcing steel, formwork, cured concrete, and concrete and asphalt batch plants; adjusting proportions of bituminous mixtures.

OPERATING ENGINEERS - BUILDING

Class 1. Asphalt Plant; Asphalt Spreader; Autograde; Backhoes with Caisson Attachment; Batch Plant; Benoto (requires Two Engineers); Boiler and Throttle Valve; Caisson Rigs; Central Redi-Mix Plant; Combination Back Hoe Front End-loader Machine; Compressor and Throttle Valve; Concrete Breaker (Truck Mounted); Concrete Conveyor; Concrete Paver (over 27E cu. ft.): Concrete Paver (27 cu. ft. and under); Concrete Placer; Concrete Pump (Truck Mounted); Concrete Conveyor (Truck Mounted); Concrete Tower; Cranes, All; GCI and similar types (required two operators only); Cranes, Hammerhead; Creter Crane; Crusher, Stone, etc.; Derricks, All; Derricks, Traveling; Formless Curb and Gutter Machine; Grader, Elevating; Grouting Machines; Highlift Shovels or Front Endloader 2-1/4 yd. and over; Hoists, Elevators, outside type rack and pinion and similar machines; Hoists, one, two and three Drum; Hoists, Two Tugger One Floor; Hydraulic Backhoes; Hydraulic Boom Trucks; Locomotives, All; Lubrication Technician; Manipulators; Motor Patrol; Pile Drivers and Skid Rig; Post Hole Digger; Pre-Stress Machine; Pump Cretes Dual Ram; Pump Cretes: Squeeze Cretes - Screw Type Pumps, Gypsum Bulker and Pump; Raised and Blind Hole Drill; Rock Drill (self-propelled); Rock Drill - Truck Mounted; Roto Mill Grinder; Scoops - Tractor Drawn; Slipform Paver; Scrapers Prime Movers; Straddle Buggies; Tie Back Machine; Tractor with Boom and Side Boom; Trenching Machines.

Class 2. Bobcat (over 3/4 cu. yd.); Boilers; Brick Forklift; Broom, All Power Propelled; Bulldozers; Concrete Mixer (Two Bag and Over); Conveyor, Portable; Forklift Trucks; Highlift Shovels or Front Endloaders under 2-1/4 yd.; Hoists, Automatic; Hoists, Sewer Dragging Machine; Hoists, Tugger Single Drum; Rollers, All; Steam Generators; Tractors, All; Tractor Drawn Vibratory Roller; Winch Trucks with "A" Frame.

Class 3. Air Compressor; Asphalt Spreader; Combination - Small Equipment Operator; Generators; Heaters, Mechanical; Hoists, Inside Elevators - (Rheostat Manual Controlled); Hydraulic Power Units (Pile Driving and Extracting); Pumps, Over 3" (1 to 3 not to exceed total of 300 ft.); Pumps, Well Points; Welding Machines (2 through 5); Winches, 4 Small Electric Drill Winches; Bobcat (up to and including 3/4 cu. yd.).

Class 4. Elevator push button with automatic doors; Hoists, Inside; Oilers; Brick Forklift.

Class 5. Assistant Craft Foreman

Class 6. Mechanics

Class 7. Gradall

OPERATING ENGINEERS - HIGHWAY CONSTRUCTION

Class 1. Asphalt Plant; Asphalt Heater and Planer Combination; Asphalt Heater Scarfire; Asphalt Silo Tender; Asphalt Spreader; Autograder; ABG Paver; Backhoes with Caisson Attachment; Ballast Regulator; Belt Loader; Caisson Rigs; Car Dumper; Central Redi-Mix Plant; Backhoe w/shear attachments; Combination Backhoe Front Endloader Machine, (1 cu. yd. Backhoe Bucket or over or with attachments); Concrete Breaker (Truck Mounted); Concrete Conveyor; Concrete Paver over 27E cu. ft.; Concrete Placer; Concrete Tube Float; Cranes, all attachments; Cranes, Tower of all types; Creter Crane; Crusher, Stone, etc.; Derricks, All; Derrick Boats; Derricks, Traveling; Directional Boring Machine over 12"; Dredges; Formless Curb and Gutter Machine; Grader, Elevating; Grader, Motor Grader, Motor Patrol, Auto Patrol, Form Grader, Pull Grader, Subgrader; Guard Rail Post Driver Mounted; Hoists, One, Two and Three Drum; Hydraulic Backhoes; Lubrication Technician; Manipulators; Pile Drivers and Skid Rig; Pre-Stress Machine; Pump Cretes Dual Ram; Rock Drill - Crawler or Skid Rig; Rock Drill - Truck Mounted; Rock/Track Tamper; Roto Mill Grinder; Slip-Form Paver; Soil Test Drill Rig (Truck Mounted); Straddle Buggies; GCI Crane; Hydraulic Telescoping Form (Tunnel); Tie Back Machine; Tractor Drawn Belt Loader; Tractor Drawn Belt Loader with attached pusher; Tractor with Boom; Tractaire with Attachments; Traffic Barrier Conveyor Machine; Raised or Blind Hole Drills; Trenching Machine (over 12"); Truck Mounted Concrete Pump with Boom; Truck Mounted Concrete Conveyor; Underground Boring and/or Mining Machines; Wheel Excavator; Widener (APSCO).

Class 2. Batch Plant; Bituminous Mixer; Boiler and Throttle Valve; Bulldozers; Car Loader Trailing Conveyors; Combination Backhoe Front Endloader Machine (less than 1 cu. yd. Backhoe Bucket or over or with attachments); Compressor and Throttle Valve; Compressor, Common Receiver (3); Concrete Breaker or Hydro Hammer; Concrete Grinding Machine; Concrete Mixer or Paver 7S Series to and including 27 cu. ft.; Concrete Spreader; Concrete Curing Machine, Burlap Machine, Belting Machine and Sealing Machine; Conveyor Muck Cars (Haglund or Similar Type); Drills, all; Finishing Machine - Concrete; Highlift Shovels or Front Endloader; Hoist - Sewer Dragging Machine; Hydraulic Boom Trucks (All Attachments); Hydro Blaster; All Locomotives, Dinky; Off-Road Hauling Units (including articulating) / 2 ton capacity or more; Non-Self Loading Ejection Dump; Pump Cretes: Squeeze Cretes - Screw Type Pumps, Gypsum Bulker and Pump; Roller, Asphalt; Rotary Snow Plows; Rototiller, Seaman, etc., self-propelled; Scoops - Tractor Drawn; Self-Propelled Compactor; Spreader - Chip - Stone, etc.; Scraper; Scraper - Prime Mover in Tandem (Regardless of Size); Tank

Car Heater; Tractors, Push, Pulling Sheeps Foot, Disc, Compactor, etc.; Tug Boats.

Class 3. Boilers; Brooms, All Power Propelled; Cement Supply Tender; Compressor, Common Receiver (2); Concrete Mixer (Two Bag and Over); Conveyor, Portable; Farm-Type Tractors Used for Mowing, Seeding, etc.; Fireman on Boilers; Forklift Trucks; Grouting Machine; Hoists, Automatic; Hoists, All Elevators; Hoists, Tugger Single Drum; Jeep Diggers; Low Boys; Pipe Jacking Machines; Post-Hole Digger; Power Saw, Concrete Power Driven; Pug Mills; Rollers, other than asphalt; Seed and Straw Blower; Steam Generators; Stump Machine; Winch Trucks with "A" Frame; Work Boats; Tamper - Form - Motor Driven.

Class 4. Air Compressor - Small and Large; Asphalt Spreader, Backend Man; Bobcat (Skid Steer) all; Brick Forklift; Combination - Small Equipment Operator; Directional Boring Machine up to 12"; Generators; Heaters, Mechanical; Hydraulic Power Unit (Pile Driving, Extracting, or Drilling); Hydro-Blaster; Light Plants, All (1 through 5); Pumps, over 3" (1 to 3 not to exceed a total of 300 ft.); Pumps, Well Points; Tractaire; Trencher 12" and under; Welding Machines (2 through 5); Winches, 4 Small Electric Drill Winches.

Class 5. Oilers and Directional Boring Machine Locator.

Class 6. Field Mechanics and Field Welders

Class 7. Gradall and machines of like nature.

TRUCK DRIVER - BUILDING, HEAVY AND HIGHWAY CONSTRUCTION - SOUTH

Class 1. Drivers on 2 axle trucks hauling less than 9 ton. Air compressor and welding machines and brooms, including those pulled by separate units, truck driver helpers, warehouse employees, mechanic helpers, greasers and tiremen, pickup trucks when hauling materials, tools, or workers to and from and on-the-job site, and fork lifts up to 6,000 lb. capacity.

Class 2. Two or three axle trucks hauling more than 9 ton but hauling less than 16 ton. A-frame winch trucks, hydrolift trucks, vector trucks or similar equipment when used for transportation purposes. Fork lifts over 6,000 lb. capacity, winch trucks, four axle combination units, and ticket writers.

Class 3. Two, three or four axle trucks hauling 16 ton or more. Drivers on water pulls, articulated dump trucks, mechanics and working forepersons, and dispatchers. Five axle or more combination units.

Class 4. Low Boy and Oil Distributors.

Class 5. Drivers who require special protective clothing while employed on hazardous waste work.

TRUCK DRIVER - OIL AND CHIP RESEALING ONLY.

This shall encompass laborers, workers and mechanics who drive contractor or subcontractor owned, leased, or hired pickup, dump, service, or oil distributor trucks. The work includes transporting materials and equipment (including but not limited to, oils, aggregate supplies, parts, machinery and tools) to or from the job site; distributing oil or liquid asphalt and aggregate; stock piling

material when in connection with the actual oil and chip contract. The Truck Driver (Oil & Chip Resealing) wage classification does not include supplier delivered materials.

TRUCK DRIVER - BUILDING, HEAVY AND HIGHWAY CONSTRUCTION - EAST AND NORTH

Class 1. Two or three Axle Trucks. A-frame Truck when used for transportation purposes; Air Compressors and Welding Machines, including those pulled by cars, pick-up trucks and tractors; Ambulances; Batch Gate Lockers; Batch Hopperman; Car and Truck Washers; Carry-alls; Fork Lifts and Hoisters; Helpers; Mechanics Helpers and Greasers; Oil Distributors 2-man operation; Pavement Breakers; Pole Trailer, up to 40 feet; Power Mower Tractors; Self-propelled Chip Spreader; Skipman; Slurry Trucks, 2-man operation; Slurry Truck Conveyor Operation, 2 or 3 man; Teamsters; Unskilled dumpman; and Truck Drivers hauling warning lights, barricades, and portable toilets on the job site.

Class 2. Four axle trucks; Dump Crets and Adgetors under 7 yards; Dumpsters, Track Trucks, Euclids, Hug Bottom Dump Turnapulls or Turnatrailers when pulling other than self-loading equipment or similar equipment under 16 cubic yards; Mixer Trucks under 7 yards; Ready-mix Plant Hopper Operator, and Winch Trucks, 2 Axles.

Class 3. Five axle trucks; Dump Crets and Adgetors 7 yards and over; Dumpsters, Track Trucks, Euclids, Hug Bottom Dump Turnatrailers or turnapulls when pulling other than self-loading equipment or similar equipment over 16 cubic yards; Explosives and/or Fission Material Trucks; Mixer Trucks 7 yards or over; Mobile Cranes while in transit; Oil Distributors, 1-man operation; Pole Trailer, over 40 feet; Pole and Expandable Trailers hauling material over 50 feet long; Slurry trucks, 1-man operation; Winch trucks, 3 axles or more; mechanic--Truck Welder and Truck Painter.

Class 4. Six axle trucks; Dual-purpose vehicles, such as mounted crane trucks with hoist and accessories; Foreman; Master Mechanic; Self-loading equipment like P.B. and trucks with scoops on the front.

Other Classifications of Work:

For definitions of classifications not otherwise set out, the Department generally has on file such definitions which are available. If a task to be performed is not subject to one of the classifications of pay set out, the Department will upon being contacted state which neighboring county has such a classification and provide such rate, such rate being deemed to exist by reference in this document. If no neighboring county rate applies to the task, the Department shall undertake a special determination, such special determination being then deemed to have existed under this determination. If a project requires these, or any classification not listed, please contact IDOL at 217-782-1710 for wage rates or clarifications.

LANDSCAPING

Landscaping work falls under the existing classifications for laborer, operating engineer and truck driver. The work performed by landscape plantsman and landscape laborer is covered by the existing classification of laborer. The work performed by landscape operators

(regardless of equipment used or its size) is covered by the classifications of operating engineer. The work performed by landscape truck drivers (regardless of size of truck driven) is covered by the classifications of truck driver.

Rock Island County Prevailing Wage for February 2012

Trade Name	RG	TYP	C	Base	FRMAN	*M-F>8	OSA	OSH	H/W	Pensn	Vac	Trng
=====	==	===	=	=====	=====	=====	===	===	=====	=====	=====	=====
ASBESTOS ABT-GEN		BLD		23.080	24.000	1.5	1.5	2.0	5.850	6.720	0.000	0.800
ASBESTOS ABT-GEN		HWY		25.090	26.090	1.5	1.5	2.0	6.150	6.720	0.000	0.800
ASBESTOS ABT-MEC		BLD		20.500	21.500	1.5	1.5	2.0	6.250	3.500	0.000	0.000
BOILERMAKER		BLD		34.170	37.170	2.0	2.0	2.0	6.820	8.550	0.000	0.350
BRICK MASON		BLD		26.450	27.950	1.5	1.5	2.0	7.750	5.150	0.000	0.470
CARPENTER		BLD		26.380	27.700	1.5	1.5	2.0	7.790	7.660	0.000	0.600
CARPENTER		HWY		27.640	29.390	1.5	1.5	2.0	8.230	10.34	0.000	0.450
CEMENT MASON		BLD		24.820	26.820	1.5	1.5	2.0	5.850	8.420	0.000	0.500
CEMENT MASON		HWY		24.730	25.730	1.5	1.5	2.0	6.400	9.180	0.000	0.500
CERAMIC TILE FNSHER		BLD		18.460	0.000	1.5	1.5	2.0	7.750	5.140	0.000	0.230
ELECTRIC PWR EQMT OP		ALL		27.850	0.000	1.5	1.5	2.0	5.000	8.360	0.000	0.210
ELECTRIC PWR GRNDMAN		ALL		23.280	0.000	1.5	1.5	2.0	5.000	6.990	0.000	0.170
ELECTRIC PWR LINEMAN		ALL		35.130	38.640	1.5	1.5	2.0	5.000	10.53	0.000	0.260
ELECTRICIAN		BLD		31.520	33.520	1.5	1.5	2.0	7.220	10.52	0.000	0.310
ELECTRONIC SYS TECH		BLD		23.500	25.250	1.5	1.5	2.0	7.020	5.150	0.000	0.310
ELEVATOR CONSTRUCTOR		BLD		39.140	44.030	2.0	2.0	2.0	11.03	11.96	2.350	0.000
GLAZIER		BLD		25.780	27.280	1.5	1.5	2.0	6.670	6.120	0.000	0.350
HT/FROST INSULATOR		BLD		28.860	30.060	1.5	1.5	2.0	5.250	12.05	0.000	0.800
IRON WORKER		ALL		27.500	29.700	1.5	1.5	2.0	8.890	10.18	0.000	0.620
LABORER		BLD	1	21.580	22.440	1.5	1.5	2.0	6.150	6.720	0.000	0.800
LABORER		BLD	2	23.080	24.000	1.5	1.5	2.0	6.150	6.720	0.000	0.800
LABORER		BLD	3	23.730	24.680	1.5	1.5	2.0	6.150	6.720	0.000	0.800
LABORER		HWY	1	24.590	25.590	1.5	1.5	2.0	6.150	6.720	0.000	0.800
LABORER		HWY	2	25.090	26.090	1.5	1.5	2.0	6.150	6.720	0.000	0.800
LABORER		HWY	3	25.720	26.720	1.5	1.5	2.0	6.150	6.720	0.000	0.800
LATHER		BLD		26.380	27.700	1.5	1.5	2.0	7.790	7.660	0.000	0.600
MACHINIST		BLD		43.160	45.160	1.5	1.5	2.0	7.980	8.950	0.000	0.000
MARBLE FINISHERS		BLD		18.460	0.000	1.5	1.5	2.0	7.750	5.140	0.000	0.230
MARBLE MASON		BLD		22.800	23.300	1.5	1.5	2.0	7.750	5.140	0.000	0.230
MILLWRIGHT	N	BLD		34.400	37.840	1.5	1.5	2.0	7.100	11.94	0.000	0.500
MILLWRIGHT	S	BLD		27.250	28.950	1.5	1.5	2.0	6.400	9.640	0.000	0.500
OPERATING ENGINEER		BLD	1	29.400	30.400	1.5	1.5	2.0	13.95	6.600	1.500	0.800
OPERATING ENGINEER		BLD	2	27.800	30.400	1.5	1.5	2.0	13.95	6.600	1.500	0.800
OPERATING ENGINEER		BLD	3	26.650	30.400	1.5	1.5	2.0	13.95	6.600	1.500	0.800
OPERATING ENGINEER		BLD	4	29.650	30.650	1.5	1.5	2.0	13.95	6.600	1.500	0.800
OPERATING ENGINEER		BLD	5	30.150	31.150	1.5	1.5	2.0	13.95	6.600	1.500	0.800
OPERATING ENGINEER		BLD	6	30.650	31.650	1.5	1.5	2.0	13.95	6.600	1.500	0.800
OPERATING ENGINEER		BLD	7	30.400	31.400	1.5	1.5	2.0	13.95	6.600	1.500	0.800
OPERATING ENGINEER		HWY	1	29.400	30.400	1.5	1.5	2.0	13.95	6.600	1.500	0.800
OPERATING ENGINEER		HWY	2	27.800	30.400	1.5	1.5	2.0	13.95	6.600	1.500	0.800
OPERATING ENGINEER		HWY	3	26.650	30.400	1.5	1.5	2.0	13.95	6.600	1.500	0.800
OPERATING ENGINEER		HWY	4	29.650	30.650	1.5	1.5	2.0	13.95	6.600	1.500	0.800
OPERATING ENGINEER		HWY	5	30.150	31.150	1.5	1.5	2.0	13.95	6.600	1.500	0.800
OPERATING ENGINEER		HWY	6	30.650	31.650	1.5	1.5	2.0	13.95	6.600	1.500	0.800
OPERATING ENGINEER		HWY	7	29.900	30.900	1.5	1.5	2.0	13.95	6.600	1.500	0.800
OPERATING ENGINEER		HWY	8	30.400	31.400	1.5	1.5	2.0	13.95	6.600	1.500	0.800
PAINTER		ALL		26.820	27.820	1.5	1.5	1.5	5.000	6.100	0.000	0.600
PAINTER OVER 30FT		ALL		28.070	29.070	1.5	1.5	1.5	5.000	6.100	0.000	0.600
PAINTER PWR EQMT		ALL		27.320	28.320	1.5	1.5	1.5	5.000	6.100	0.000	0.600
PILEDRIVER		BLD		26.380	27.700	1.5	1.5	2.0	7.790	7.660	0.000	0.600
PILEDRIVER		HWY		27.640	29.390	1.5	1.5	2.0	8.230	10.34	0.000	0.450
PIPEFITTER		ALL		35.700	39.270	1.5	1.5	2.0	5.150	11.35	0.000	1.000
PLASTERER		BLD		27.800	29.800	1.5	1.5	2.0	6.500	5.950	0.000	0.500
PLUMBER		ALL		35.700	39.270	1.5	1.5	2.0	5.150	11.35	0.000	1.000
ROOFER		BLD		24.630	25.880	1.5	1.5	2.0	8.110	5.370	0.000	0.250
SHEETMETAL WORKER		BLD		29.930	31.920	1.5	1.5	2.0	7.140	10.24	0.000	0.540
SPRINKLER FITTER		BLD		36.140	38.890	1.5	1.5	2.0	8.100	8.200	0.000	0.350
STONE MASON		BLD		26.450	27.950	1.5	1.5	2.0	7.750	5.150	0.000	0.470

TERRAZZO FINISHER	BLD	18.460	0.000	1.5	1.5	2.0	7.750	5.140	0.000	0.230
TERRAZZO MASON	BLD	22.800	23.300	1.5	1.5	2.0	7.750	5.140	0.000	0.230
TILE LAYER	BLD	26.380	27.700	1.5	1.5	2.0	7.790	7.660	0.000	0.600
TILE MASON	BLD	22.800	23.300	1.5	1.5	2.0	7.750	5.140	0.000	0.230
TRUCK DRIVER	ALL 1	30.460	0.000	1.5	1.5	2.0	10.05	4.775	0.000	0.250
TRUCK DRIVER	ALL 2	30.890	0.000	1.5	1.5	2.0	10.05	4.775	0.000	0.250
TRUCK DRIVER	ALL 3	31.120	0.000	1.5	1.5	2.0	10.05	4.775	0.000	0.250
TRUCK DRIVER	ALL 4	31.380	0.000	1.5	1.5	2.0	10.05	4.775	0.000	0.250
TRUCK DRIVER	ALL 5	32.200	0.000	1.5	1.5	2.0	10.05	4.775	0.000	0.250
TRUCK DRIVER	O&C 1	24.370	0.000	1.5	1.5	2.0	10.05	4.775	0.000	0.250
TRUCK DRIVER	O&C 2	24.710	0.000	1.5	1.5	2.0	10.05	4.775	0.000	0.250
TRUCK DRIVER	O&C 3	24.900	0.000	1.5	1.5	2.0	10.05	4.775	0.000	0.250
TRUCK DRIVER	O&C 4	25.100	0.000	1.5	1.5	2.0	10.05	4.775	0.000	0.250
TRUCK DRIVER	O&C 5	25.760	0.000	1.5	1.5	2.0	10.05	4.775	0.000	0.250
TUCKPOINTER	BLD	26.450	27.950	1.5	1.5	2.0	7.750	5.150	0.000	0.470

Legend:

M-F>8 (Overtime is required for any hour greater than 8 worked each day, Monday through Friday.)

OSA (Overtime is required for every hour worked on Saturday)

OSH (Overtime is required for every hour worked on Sunday and Holidays)

H/W (Health & Welfare Insurance)

Pensn (Pension)

Vac (Vacation)

Trng (Training)

Explanations

ROCK ISLAND COUNTY

MILLWRIGHT (SOUTH) - South of Interstate 80.

The following list is considered as those days for which holiday rates of wages for work performed apply: New Years Day, Memorial Day, Fourth of July, Labor Day, Thanksgiving Day, Christmas Day and Veterans Day in some classifications/counties. Generally, any of these holidays which fall on a Sunday is celebrated on the following Monday. This then makes work performed on that Monday payable at the appropriate overtime rate for holiday pay. Common practice in a given local may alter certain days of celebration. If in doubt, please check with IDOL.

Oil and chip resealing (O&C) means the application of road oils and liquid asphalt to coat an existing road surface, followed by application of aggregate chips or gravel to coated surface, and subsequent rolling of material to seal the surface.

EXPLANATION OF CLASSES

ASBESTOS - GENERAL - removal of asbestos material/mold and hazardous materials from any place in a building, including mechanical systems where those mechanical systems are to be removed. This includes the removal of asbestos materials/mold and hazardous materials from

ductwork or pipes in a building when the building is to be demolished at the time or at some close future date.

ASBESTOS - MECHANICAL - removal of asbestos material from mechanical systems, such as pipes, ducts, and boilers, where the mechanical systems are to remain.

CERAMIC TILE FINISHER, MARBLE FINISHER, TERRAZZO FINISHER

Assisting, helping or supporting the tile, marble and terrazzo mechanic by performing their historic and traditional work assignments required to complete the proper installation of the work covered by said crafts. The term "Ceramic" is used for naming the classification only and is in no way a limitation of the product handled. Ceramic takes into consideration most hard tiles.

ELECTRONIC SYSTEMS TECHNICIAN

Installing, assembling and maintaining sound and intercom, protection alarm (security), master antenna television, closed circuit television, computer hardware and software programming and installation to the network's outlet and input (EXCLUDING all cabling, power and cable termination work historically performed by wiremen), door monitoring and control, nurse and emergency call programming and installation to the system's outlet and input (EXCLUDING all cabling, power and cable termination work historically performed by wiremen), clock and timing; and the installation and maintenance of transmit and receive antennas, transmitters, receivers, and associated apparatus which operates in conjunction with the above systems. All work associated with these system installations will be included EXCEPT (1) installation of protective metallic conduit, excluding less than ten-foot runs strictly for protection of cable, and (2) 120 volt AC (or higher) power wiring and associated hardware.

LABORER - BUILDING

Class 1: General laborer, carpenter tender, tool cribman, salamander tender, flagman, form handler, floor sweeper, material handler, fencing laborer, cleaning lumber, landscaper, unloading explosives, laying of sod, planting/removal of trees, wrecking laborer, unloading of Re-Bars, scaffold worker, signal man on crane.

Class 2: Handling of materials treated with creosote, kettle men, prime mover or motorized unit used for wet concrete or handling of building materials, vibrator operator, motar mixer, power tools used under the jurisdiction of laborers, sand points, gunnite nozzle men, welders, cutters, burners and torchmen, chain saw operator, jackhammer and drill operators, paving breakers, air tamping hammerman, concrete saw operator, concrete burning machine operator, coring machine operator - hod carrier and plasterer tender.

Class 3: Caisson worker after 6 foot depth, dynamite man, asbestos abatement worker, tunnel miners - mixerman (plaster only), pump man.

LABORER - HEAVY & HIGHWAY

Class 1: Rod or chain man, flagman, dumpman, spotter, broom man, landscaper, planting and removal of trees, fencing laborers, dispatcher, ticket writer, scaleman, cleaning of forms or lumber (in bone yard), laying of sod, moving and/or maintenance of flares and barricades.

Class 2: Operation of all hand, electric, air, hydraulic or mechanically powered tools under the jurisdiction of Laborers'

including jackhammers, tempers, air spades, augers, concrete saws, chain saws, utility saws, rock drills, vibrators, mortar mixer, power and hand saw (when clearing timber) general laborer (not elsewhere covered), craft-tender, material checker, material handler, form handler, concrete dumper, puddler, form setter helper, explosives handler, dynamite helper, center strip, reinforcing in concrete, wire mesh handler and installer, prime mover or any mechanical device taking the place of concrete buggy or wheelbarrow, sandpoint setter, asphalt kettleman. Sheeting hammer drivers, laying and jointing of telephone conduit, gas distribution men, pipe setter on laterals, drain tiles, culvert pipe, and storm sewer catch basin leads, catch basins, manholes, batch dumpers, tank cleaners, cofferdam workers, bankman on floating plant, jointman with pipelayers. Back-up man (corker, joint maker) with pipe setter on sewer and water mains, batterboard man or laser operator on sewer and water main, labor in ditch, or tunnel, on sewer or water mains and telephone conduit. Cutters, burners, torchman, gravel box man, asphalt plant laborers, concrete plant laborer, deck hand, unloading of steel and rebar, laser beam operator, wrecking laborers.

Class 3: Asphalt raker or luteman, head form setter, head dynamite man (powderman) head string or wireline man (on paving), pipe setter on sewer or water main, gunnite nozzle man, asphalt or concrete curb machine operator, head grade man, head tunnel miner, concrete burning machine operator, coring machine operator, welder.

OPERATING ENGINEERS - BUILDING

Class 1. Shovel; Concrete Spreader; Dipper Dredge Operator; Dipper Dredge Crane man; Dual Purpose Truck (boom, Boom, Winch, etc.); Mechanic-Welder; Pile Driver; Boom Tractor or Side Boom; Trenching Machine (40 H.P. and over); Building Hoist (1, 2 or 3 drums); Cleaning and Priming Machine; Backfiller (throw bucket); Locomotive Engineer; Concrete Paver; Slip Form Paver; Caisson Augering Machines; Mucking Machine; Asphalt Heater-Planer Unit; Laser Screed; Pug Mill; Concrete Conveyor or Pump; Mechanical loaded Log Chippers or similar machines; Group Equipment Greaser; Off-Road Haul Units; Pipe Bending; Automatic Curbing Machines; Blastholer; Self-Propelled Rotary Drill or similar machines; Work Boat; Combination Concrete Finishing Machine and Float; Asphalt Paver Screed Operator; Forklift (6,000 lb. cap. or over or working heights 28 ft. and above); Chip Spreader; Straddle Carrier; Asphalt Paver; Asphalt Plant Operator; Boring Machine (Directional, Vertical, or Horizontal); Central Redi-Mix Plant Operator; Combination Backhoe Front End loader; Concrete Breaker or Hydro-Hammer (excluding walk-behinds); Concrete Wheel Saw (Large self-propelled - excluding walk-behinds); Crusher (Stone, Concrete, Asphalt, etc.); Curing-Tinning Machine; Excavator; Farm-type Tractor Operating Scoop or Scraper or with Power Attachment; Grader; Motor Grader; Motor Patrol; Auto Grader; Form Grader; Pull Grader; Sub Grader; Elevating Grader; Guard Rail Post Driver; Hoists; Hydraulic Dredge Leverman or Engineer; Hydro-Vac truck mounted or pull type (excluding hose work), and similar equipment; Loader (Track, Rubber Tire, or Articulated); Milling Machine (excluding walk-behinds); Road Widener-Shoulder Spreader; Scraper (Self-Propelled); Self-Propelled Roller or Tire Roller (on asphalt or Blacktop); Sheep Foot or Pad Foot Compactor (excluding walk-behinds); Steel Track-Type Tractor (Dozer, Push Cat, etc.); Transfer or Shuttle Buggy (excluding motorized wheel barrows and Georgia buggies).

Class 2. Asphalt Booster; Fireman and Pump Operator at Asphalt Plant; Mud Jack; Distributor; Self-propelled Roller (other than provided for in Class I); Pump Operator (more than one well-point pump); Trench Machine (under 40 H.P.); Forklift (less than 6,000 lb. cap. or working

heights below 28 ft.); Gypsum Pump; Conveyor over 20 H.P.; Light Plant; Boiler (Engineer or Fireman); Mechanical Broom; Driver on Truck Crane or similar machines; Elevator (Permanent inside or Temporary outside); Farm-Type Tractor (without Power Attachment); Grout Pump (excluding hose work).

Class 3. Skid Loader; Oiler; Mechanic's Helper; Mechanical Heater (other than steam boiler); Small Outboard Motor Boat (Safety Boat and Life Boat); Engine Driven Welding Machine; Water Pumps; Air Compressor (400 c.f.m. or over); Deck Engineers.

Class 4. Leadman - Mechanic or Equipment Greaser.

Class 5. Track Excavator with Bucket (4 cubic yard and up to but not including 6 cubic yard).

Class 6. Track Excavator with Bucket (6 cubic yard and over).

Class 7. Crane (Friction or Hydraulic, regardless of size or attachments); Tow or Push Boat.

OPERATING ENGINEERS- HIGHWAY

Class 1. Shovel; Concrete Spreader; Dipper Dredge Operator; Dipper Dredge Crane man; Dual Purpose Truck (Boom, Winch, etc.); Mechanic-Welder; Pile Driver; Boom Tractor or Side Boom; Building Hoist (1, 2 or 3 drums); Cleaning and Priming Machine; Backfiller (throw bucket); Locomotive Engineer; Concrete Paver; Slip Form Paver; Caisson Augering Machines; Mucking Machine; Asphalt Heater Planer Unit; Laser Screed; Pug Mill; Concrete Conveyor or Pump (excluding truck-mounted); Mechanical loaded Log Chippers or similar machines; Group Equipment Greaser; off-road haul units; Pipe Bending; Automatic Curbing Machines; Blastholer; Self-propelled Rotary Drill or similar machines; Work Boat; Combination Concrete Finishing Machine and Float; Asphalt Paver Screed Operator; Forklift (6,000 lb. cap. or over or working heights above 28 ft.); Chip Spreader; Asphalt Paver; Asphalt Plant Operator; Boring Machine (Directional, Vertical, or Horizontal); Central Redi-Mix Plant Operator; Combination Backhoe Front End loader; Concrete Breaker or Hydro-Hammer (excluding walk-behinds); Concrete Wheel Saw (Large self-propelled - excluding walk-behinds); Crusher (Stone, Concrete, Asphalt, etc.); Curing-Tinning Machine; Excavator; Farm-Type Tractor Operating Scoop or Scraper with Power Attachment; Grader; Motor Grader; Motor Patrol; Auto Grader; Form Grader; Pull Grader; Sub Grader; Elevating Grader; Guard Rail Post Driver; Hoists; Hydraulic Dredge Leverman or Engineer; Hydro-Vac truck mounted or pull type, and similar equipment; Loader (Track, Rubber Tire, or Articulated); Milling Machine (excluding walk-behinds); Road Widener-Shoulder Spreader; Scraper (self-propelled); Self-propelled Roller or Tire Roller (on asphalt or Blacktop); Sheep Foot or Pad Foot Compactor (excluding walk-behinds); Steel Track-Type Tractor (Dozer, Push Cat, etc.); Transfer or Shuttle Buggy (excluding motorized wheel barrows and Georgia buggies); Trenching Machine (40 H.P. and over).

Class 2. Asphalt Booster; Fireman and Pump Operator at Asphalt Plant; Mud Jack; Farm-Type Tractor without Power attachment; Distributor; Straddle Carrier; Self-propelled Roller or Compactor (other than provided for in Class I); Pump Operator (more than one well-point pump); Trench Machine (under 40 H.P.); Forklift (less than 6,000 lb. capacity or working heights below 28 ft.); Conveyor over 20 H.P.; Air Compressor (400 c.f.m. or over); Light Plant; Boiler (Engineer or Fireman); Mechanical Broom; Driver on Truck Crane or similar machines; Elevator (Permanent inside or Temporary outside); Grout Pump (excluding hose work).

Class 3. Oiler; Mechanic's Helper; Mechanical Heater (other than steam boiler); Small Outboard Motor Boat (Safety Boat and Life Boat); Engine Driven Welding Machine; skid steer.

Class 4. Leadman - Mechanic or Equipment Greaser.

Class 5. Track Excavator with Bucket (4 cubic yard and up to but not including 6 cubic yard).

Class 6. Track Excavator with Bucket (6 cubic yard and over).

Class 7. Truck mounted Concrete Conveyor or Pumps Extending to 90 ft. or more.

Class 8. Crane (Friction or Hydraulic, regardless of size or attachments); Tow or Push Boat.

TRUCK DRIVER - BUILDING, HEAVY AND HIGHWAY CONSTRUCTION

Class 1. Drivers on 2 axle trucks hauling less than 9 ton. Air compressor and welding machines and brooms, including those pulled by separate units, truck driver helpers, warehouse employees, mechanic helpers, greasers and tiremen, pickup trucks when hauling materials, tools, or workers to and from and on-the-job site, and fork lifts up to 6,000 lb. capacity.

Class 2. Two or three axle trucks hauling more than 9 ton but hauling less than 16 ton. A-frame winch trucks, hydrolift trucks, vactor trucks or similar equipment when used for transportation purposes. Fork lifts over 6,000 lb. capacity, winch trucks, four axle combination units, and ticket writers.

Class 3. Two, three or four axle trucks hauling 16 ton or more. Drivers on water pulls, articulated dump trucks, mechanics and working forepersons, and dispatchers. Five axle or more combination units.

Class 4. Low Boy and Oil Distributors.

Class 5. Drivers who require special protective clothing while employed on hazardous waste work.

TRUCK DRIVER - OIL AND CHIP RESEALING ONLY.

This shall encompass laborers, workers and mechanics who drive contractor or subcontractor owned, leased, or hired pickup, dump, service, or oil distributor trucks. The work includes transporting materials and equipment (including but not limited to, oils, aggregate supplies, parts, machinery and tools) to or from the job site; distributing oil or liquid asphalt and aggregate; stock piling material when in connection with the actual oil and chip contract. The Truck Driver (Oil & Chip Resealing) wage classification does not include supplier delivered materials.

Other Classifications of Work:

For definitions of classifications not otherwise set out, the Department generally has on file such definitions which are available. If a task to be performed is not subject to one of the classifications of pay set out, the Department will upon being contacted state which neighboring county has such a classification and provide such rate, such rate being deemed to exist by reference in this document. If no neighboring county rate applies to the task,

the Department shall undertake a special determination, such special determination being then deemed to have existed under this determination. If a project requires these, or any classification not listed, please contact IDOL at 217-782-1710 for wage rates or clarifications.

LANDSCAPING

Landscaping work falls under the existing classifications for laborer, operating engineer and truck driver. The work performed by landscape plantsman and landscape laborer is covered by the existing classification of laborer. The work performed by landscape operators (regardless of equipment used or its size) is covered by the classifications of operating engineer. The work performed by landscape truck drivers (regardless of size of truck driven) is covered by the classifications of truck driver.

Stephenson County Prevailing Wage for February 2012

Trade Name	RG	TYP	C	Base	FRMAN	*M-F>8	OSA	OSH	H/W	Pensn	Vac	Trng
=====	==	===	=	=====	=====	=====	===	===	=====	=====	=====	=====
ASBESTOS ABT-GEN		BLD		29.400	30.400	1.5	1.5	2.0	8.040	12.02	0.000	0.800
ASBESTOS ABT-MEC		BLD		18.950	0.000	1.5	1.5	2.0	2.700	3.350	0.000	0.000
BOILERMAKER		BLD		34.170	37.170	2.0	2.0	2.0	6.820	8.550	0.000	0.350
BRICK MASON		BLD		35.710	38.460	1.5	1.5	2.0	7.400	11.73	0.000	0.570
CARPENTER		BLD		32.040	35.560	1.5	1.5	2.0	8.520	12.87	0.000	0.600
CARPENTER		HWY		32.440	34.190	1.5	1.5	2.0	9.250	11.99	0.000	0.490
CEMENT MASON		ALL		32.520	35.270	1.5	1.5	2.0	7.400	13.78	0.000	0.250
CERAMIC TILE FNSHER		BLD		32.240	0.000	1.5	1.5	2.0	7.400	4.840	0.000	0.500
COMMUNICATION TECH		BLD		36.000	39.600	1.5	1.5	2.0	9.740	11.20	0.000	0.720
ELECTRIC PWR EQMT OP		ALL		34.240	45.510	1.5	1.5	2.0	5.000	10.62	0.000	0.260
ELECTRIC PWR GRNDMAN		ALL		26.480	45.510	1.5	1.5	2.0	5.000	8.200	0.000	0.200
ELECTRIC PWR LINEMAN		ALL		41.000	45.510	1.5	1.5	2.0	5.000	12.71	0.000	0.310
ELECTRIC PWR TRK DRV		ALL		27.420	45.510	1.5	1.5	2.0	5.000	8.500	0.000	0.210
ELECTRICIAN		BLD		40.000	44.000	1.5	1.5	2.0	9.740	15.83	0.000	0.800
ELEVATOR CONSTRUCTOR		BLD		44.940	50.560	2.0	2.0	2.0	11.03	11.96	2.760	0.000
GLAZIER		BLD		32.730	33.730	1.5	1.5	2.0	8.950	8.200	0.000	1.250
HT/FROST INSULATOR		BLD		33.280	35.770	1.5	1.5	2.0	7.450	14.32	0.000	0.000
IRON WORKER		ALL		35.000	36.750	2.0	2.0	2.0	8.000	19.59	0.000	0.950
LABORER		BLD		29.400	30.400	1.5	1.5	2.0	8.040	12.02	0.000	0.800
LABORER		HWY		30.100	30.850	1.5	1.5	2.0	8.040	12.02	0.000	0.800
LABORER, SKILLED		HWY		32.250	33.000	1.5	1.5	2.0	8.040	12.02	0.000	0.800
LATHER		BLD		32.040	35.560	1.5	1.5	2.0	8.520	12.87	0.000	0.600
MACHINIST		BLD		43.160	45.160	1.5	1.5	2.0	7.980	8.950	0.000	0.000
MARBLE FINISHERS		BLD		32.240	0.000	1.5	1.5	2.0	7.400	4.840	0.000	0.500
MARBLE MASON		BLD		35.090	35.340	1.5	1.5	2.0	7.400	6.980	0.000	0.540
MILLWRIGHT		BLD		33.970	37.370	1.5	1.5	2.0	6.550	12.35	0.000	0.500
OPERATING ENGINEER		BLD	1	40.350	44.350	2.0	2.0	2.0	14.55	9.300	2.350	1.300
OPERATING ENGINEER		BLD	2	39.650	44.350	2.0	2.0	2.0	14.55	9.300	2.350	1.300
OPERATING ENGINEER		BLD	3	37.200	44.350	2.0	2.0	2.0	14.55	9.300	2.350	1.300
OPERATING ENGINEER		BLD	4	35.200	44.350	2.0	2.0	2.0	14.55	9.300	2.350	1.300
OPERATING ENGINEER		BLD	5	44.100	44.350	2.0	2.0	2.0	14.55	9.300	2.350	1.300
OPERATING ENGINEER		BLD	6	43.350	44.350	2.0	2.0	2.0	14.55	9.300	2.350	1.300
OPERATING ENGINEER		BLD	7	40.350	44.350	2.0	2.0	2.0	14.55	9.300	2.350	1.300
OPERATING ENGINEER		HWY	1	40.200	44.200	1.5	1.5	2.0	14.55	9.300	2.350	1.300
OPERATING ENGINEER		HWY	2	39.650	44.200	1.5	1.5	2.0	14.55	9.300	2.350	1.300
OPERATING ENGINEER		HWY	3	38.350	44.200	1.5	1.5	2.0	14.55	9.300	2.350	1.300
OPERATING ENGINEER		HWY	4	36.900	44.200	1.5	1.5	2.0	14.55	9.300	2.350	1.300
OPERATING ENGINEER		HWY	5	35.450	44.200	1.5	1.5	2.0	14.55	9.300	2.350	1.300
OPERATING ENGINEER		HWY	6	43.200	44.200	1.5	1.5	2.0	14.55	9.300	2.350	1.300
OPERATING ENGINEER		HWY	7	41.200	44.200	1.5	1.5	2.0	14.55	9.300	2.350	1.300
PAINTER		ALL		35.000	37.000	1.5	1.5	1.5	8.950	8.200	0.000	1.250
PILEDRIIVER		BLD		33.040	36.670	1.5	1.5	2.0	8.520	12.87	0.000	0.600
PILEDRIIVER		HWY		32.440	34.190	1.5	1.5	2.0	9.250	11.99	0.000	0.490
PIPEFITTER		BLD		39.250	42.000	1.5	1.5	2.0	7.980	10.59	0.000	0.950
PLASTERER		BLD		33.360	36.700	2.0	2.0	2.0	7.650	11.05	0.000	0.250
PLUMBER		BLD		39.250	42.000	1.5	1.5	2.0	7.980	10.59	0.000	0.950
ROOFER		BLD		37.650	40.650	1.5	1.5	2.0	7.750	6.570	0.000	0.430
SHEETMETAL WORKER		BLD		35.450	37.380	1.5	1.5	2.0	5.250	14.77	0.520	0.290
SPRINKLER FITTER		BLD		36.140	38.890	1.5	1.5	2.0	8.100	8.200	0.000	0.350
STONE MASON		BLD		35.710	38.460	1.5	1.5	2.0	7.400	11.73	0.000	0.570
TERRAZZO FINISHER		BLD		32.240	0.000	1.5	1.5	2.0	7.400	4.840	0.000	0.500
TERRAZZO MASON		BLD		35.090	35.340	1.5	1.5	2.0	7.400	6.980	0.000	0.540
TILE LAYER		BLD		32.040	35.560	1.5	1.5	2.0	8.520	12.87	0.000	0.600
TILE MASON		BLD		35.090	35.340	1.5	1.5	2.0	7.400	6.980	0.000	0.540
TRUCK DRIVER		ALL	1	32.960	33.420	1.5	1.5	2.0	6.900	8.220	0.000	0.000
TRUCK DRIVER		ALL	2	33.110	33.420	1.5	1.5	2.0	6.900	8.220	0.000	0.000
TRUCK DRIVER		ALL	3	33.310	33.420	1.5	1.5	2.0	6.900	8.220	0.000	0.000
TRUCK DRIVER		ALL	4	33.420	33.420	1.5	1.5	2.0	6.900	8.220	0.000	0.000

TUCKPOINTER BLD 35.710 38.460 1.5 1.5 2.0 7.400 11.73 0.000 0.570

Legend :

M-F>8 (Overtime is required for any hour greater than 8 worked each day, Monday through Friday.)

OSA (Overtime is required for every hour worked on Saturday)

OSH (Overtime is required for every hour worked on Sunday and Holidays)

H/W (Health & Welfare Insurance)

Pensn (Pension)

Vac (Vacation)

Trng (Training)

Explanations

STEPHENSON COUNTY

The following list is considered as those days for which holiday rates of wages for work performed apply: New Years Day, Memorial Day, Fourth of July, Labor Day, Thanksgiving Day, Christmas Day and Veterans Day in some classifications/counties. Generally, any of these holidays which fall on a Sunday is celebrated on the following Monday. This then makes work performed on that Monday payable at the appropriate overtime rate for holiday pay. Common practice in a given local may alter certain days of celebration. If in doubt, please check with IDOL.

EXPLANATION OF CLASSES

ASBESTOS - GENERAL - removal of asbestos material/mold and hazardous materials from any place in a building, including mechanical systems where those mechanical systems are to be removed. This includes the removal of asbestos materials/mold and hazardous materials from ductwork or pipes in a building when the building is to be demolished at the time or at some close future date.

ASBESTOS - MECHANICAL - removal of asbestos material from mechanical systems, such as pipes, ducts, and boilers, where the mechanical systems are to remain.

CERAMIC TILE FINISHER, MARBLE FINISHER, TERRAZZO FINISHER

Assisting, helping or supporting the tile, marble and terrazzo mechanic by performing their historic and traditional work assignments required to complete the proper installation of the work covered by said crafts. The term "Ceramic" is used for naming the classification only and is in no way a limitation of the product handled. Ceramic takes into consideration most hard tiles.

COMMUNICATIONS TECHNICIAN

Installing, manufacturing, assembling and maintaining sound and intercom, protection alarm (security), fire alarm, master antenna television, closed circuit television, low voltage control for

computers and/or door monitoring, school communications systems, telephones and servicing of nurse and emergency calls, and the installation and maintenance of transmit and receive antennas, transmitters, receivers, and associated apparatus which operates in conjunction with above systems. All work associated with these system installations will be included EXCEPT the installation of protective metallic conduit in new construction projects (excluding less than ten-foot, runs strictly for protection of cable) and 120 volt AC (or higher) power wiring and associated hardware.

LABORER, SKILLED - HIGHWAY

Individuals engaged in the following types of work, irrespective of the site of the work: asbestos abatement worker, handling of any materials with any foreign matter harmful to skin or clothing, track laborer, cement handlers, chloride handlers, the unloading and loading with steel workers and re-bars, concrete workers wet, tunnel helpers in free air, batch dumpers, mason tenders, kettle and tar men, tank cleaners, plastic installers, scaffold workers, motorized buggies or motorized unit used for wet concrete or handling of building materials, laborers with de-watering systems, sewer workers plus depth, rod and chainmen with technical engineers, rod and chainmen with land surveyors, rod and chainmen with surveyors, vibrator operators, cement silica, clay, fly ash, lime and plasters, handlers (bulk or bag), cofferdam workers plus depth, on concrete paving, placing, cutting and tying of reinforcing, deck hand, dredge hand, and shore laborers, bankmen on floating plant, grade checker, power tools, front end man on chip spreaders, cession workers plus depth, gunnite nozzle men, lead man on sewer work, welders, cutters, burners and torchmen, chainsaw operators, jackhammer and drill operators, layout man and/or drainage tile layer, steel form setter - street and highway, air tamping hammermen, signal man on crane, concrete saw operator, screedman on asphalt pavers, laborers tending masons with hot material or where foreign materials are used, mortar mixer operators, multiple concrete duct - leadsman, lumen, asphalt raker, curb asphalt machine operator, ready mix scalemen (permanent, portable or temporary plant), laborers handling masterplate or similar materials, laser beam operator, concrete burning machine operator, coring machine operator, plaster tender, underpinning and shoring of buildings, pump men, manhole and catch basin, dirt and stone tamper, hose men on concrete pumps, hazardous waste worker, lead base paint abatement worker, lining of pipe, refusing machine, assisting on direct boring machine, the work of laying watermain, fire hydrants, all mechanical joints to watermain work, sewer worker, and tapping water service and forced lift station mechanical worker.

OPERATING ENGINEERS - BUILDING

Class 1. Asphalt Plant; Asphalt Spreader; Autograde; Backhoes with Caisson Attachment; Batch Plant; Benoto (requires Two Engineers); Boiler and Throttle Valve; Caisson Rigs; Central Redi-Mix Plant; Combination Back Hoe Front End-loader Machine; Compressor and Throttle Valve; Concrete Breaker (Truck Mounted); Concrete Conveyor; Concrete Paver (over 27E cu. ft.): Concrete Paver (27 cu. ft. and under); Concrete Placer; Concrete Pump (Truck Mounted); Concrete Conveyor (Truck Mounted); Concrete Tower; Cranes, All; GCI and similar types (required two operators only); Cranes, Hammerhead; Creter Crane; Crusher, Stone, etc.; Derricks, All; Derricks, Traveling; Formless Curb and Gutter Machine; Grader, Elevating; Grouting Machines; Highlift Shovels or Front Endloader 2-1/4 yd. and over; Hoists, Elevators, outside type rack and pinion and similar machines; Hoists, one, two and three Drum; Hoists, Two Tugger One Floor; Hydraulic Backhoes; Hydraulic Boom Trucks; Locomotives, All; Lubrication

Technician; Manipulators; Motor Patrol; Pile Drivers and Skid Rig; Post Hole Digger; Pre-Stress Machine; Pump Cretes Dual Ram; Pump Cretes: Squeeze Cretes - Screw Type Pumps, Gypsum Bulker and Pump; Raised and Blind Hole Drill; Rock Drill (self-propelled); Rock Drill - Truck Mounted; Roto Mill Grinder; Scoops - Tractor Drawn; Slipform Paver; Scrapers Prime Movers; Straddle Buggies; Tie Back Machine; Tractor with Boom and Side Boom; Trenching Machines.

Class 2. Bobcat (over 3/4 cu. yd.); Boilers; Brick Forklift; Broom, All Power Propelled; Bulldozers; Concrete Mixer (Two Bag and Over); Conveyor, Portable; Forklift Trucks; Highlift Shovels or Front Endloaders under 2-1/4 yd.; Hoists, Automatic; Hoists, Sewer Dragging Machine; Hoists, Tugger Single Drum; Rollers, All; Steam Generators; Tractors, All; Tractor Drawn Vibratory Roller; Winch Trucks with "A" Frame.

Class 3. Air Compressor; Asphalt Spreader; Combination - Small Equipment Operator; Generators; Heaters, Mechanical; Hoists, Inside Elevators - (Rheostat Manual Controlled); Hydraulic Power Units (Pile Driving and Extracting); Pumps, Over 3" (1 to 3 not to exceed total of 300 ft.); Pumps, Well Points; Welding Machines (2 through 5); Winches, 4 Small Electric Drill Winches; Bobcat (up to and including 3/4 cu. yd.).

Class 4. Elevator push button with automatic doors; Hoists, Inside; Oilers; Brick Forklift.

Class 5. Assistant Craft Foreman

Class 6. Mechanics

Class 7. Gradall

OPERATING ENGINEERS - HIGHWAY CONSTRUCTION

Class 1. Asphalt Plant; Asphalt Heater and Planer Combination; Asphalt Heater Scarfire; Asphalt Silo Tender; Asphalt Spreader; Autograder; ABG Paver; Backhoes with Caisson Attachment; Ballast Regulator; Belt Loader; Caisson Rigs; Car Dumper; Central Redi-Mix Plant; Backhoe w/shear attachments; Combination Backhoe Front Endloader Machine, (1 cu. yd. Backhoe Bucket or over or with attachments); Concrete Breaker (Truck Mounted); Concrete Conveyor; Concrete Paver over 27E cu. ft.; Concrete Placer; Concrete Tube Float; Cranes, all attachments; Cranes, Tower of all types; Creter Crane; Crusher, Stone, etc.; Derricks, All; Derrick Boats; Derricks, Traveling; Directional Boring Machine over 12"; Dredges; Formless Curb and Gutter Machine; Grader, Elevating; Grader, Motor Grader, Motor Patrol, Auto Patrol, Form Grader, Pull Grader, Subgrader; Guard Rail Post Driver Mounted; Hoists, One, Two and Three Drum; Hydraulic Backhoes; Lubrication Technician; Manipulators; Pile Drivers and Skid Rig; Pre-Stress Machine; Pump Cretes Dual Ram; Rock Drill - Crawler or Skid Rig; Rock Drill - Truck Mounted; Rock/Track Tamper; Roto Mill Grinder; Slip-Form Paver; Soil Test Drill Rig (Truck Mounted); Straddle Buggies; GCI Crane; Hydraulic Telescoping Form (Tunnel); Tie Back Machine; Tractor Drawn Belt Loader; Tractor Drawn Belt Loader with attached pusher; Tractor with Boom; Tractaire with Attachments; Traffic Barrier Conveyor Machine; Raised or Blind Hole Drills; Trenching Machine (over 12"); Truck Mounted Concrete Pump with Boom; Truck Mounted Concrete Conveyor; Underground Boring and/or Mining Machines; Wheel Excavator; Widener (APSCO).

Class 2. Batch Plant; Bituminous Mixer; Boiler and Throttle Valve;

Bulldozers; Car Loader Trailing Conveyors; Combination Backhoe Front Endloader Machine (less than 1 cu. yd. Backhoe Bucket or over or with attachments); Compressor and Throttle Valve; Compressor, Common Receiver (3); Concrete Breaker or Hydro Hammer; Concrete Grinding Machine; Concrete Mixer or Paver 7S Series to and including 27 cu. ft.; Concrete Spreader; Concrete Curing Machine, Burlap Machine, Belting Machine and Sealing Machine; Conveyor Muck Cars (Haglund or Similar Type); Drills, all; Finishing Machine - Concrete; Highlift Shovels or Front Endloader; Hoist - Sewer Dragging Machine; Hydraulic Boom Trucks (All Attachments); Hydro Blaster; All Locomotives, Dinky; Off-Road Hauling Units (including articulating) / 2 ton capacity or more; Non-Self Loading Ejection Dump; Pump Cretes: Squeeze Cretes - Screw Type Pumps, Gypsum Bulker and Pump; Roller, Asphalt; Rotary Snow Plows; Rototiller, Seaman, etc., self-propelled; Scoops - Tractor Drawn; Self-Propelled Compactor; Spreader - Chip - Stone, etc.; Scraper; Scraper - Prime Mover in Tandem (Regardless of Size); Tank Car Heater; Tractors, Push, Pulling Sheeps Foot, Disc, Compactor, etc.; Tug Boats.

Class 3. Boilers; Brooms, All Power Propelled; Cement Supply Tender; Compressor, Common Receiver (2); Concrete Mixer (Two Bag and Over); Conveyor, Portable; Farm-Type Tractors Used for Mowing, Seeding, etc.; Fireman on Boilers; Forklift Trucks; Grouting Machine; Hoists, Automatic; Hoists, All Elevators; Hoists, Tugger Single Drum; Jeep Diggers; Low Boys; Pipe Jacking Machines; Post-Hole Digger; Power Saw, Concrete Power Driven; Pug Mills; Rollers, other than asphalt; Seed and Straw Blower; Steam Generators; Stump Machine; Winch Trucks with "A" Frame; Work Boats; Tamper - Form - Motor Driven.

Class 4. Air Compressor - Small and Large; Asphalt Spreader, Backend Man; Bobcat (Skid Steer) all; Brick Forklift; Combination - Small Equipment Operator; Directional Boring Machine up to 12"; Generators; Heaters, Mechanical; Hydraulic Power Unit (Pile Driving, Extracting, or Drilling); Hydro-Blaster; Light Plants, All (1 through 5); Pumps, over 3" (1 to 3 not to exceed a total of 300 ft.); Pumps, Well Points; Tractaire; Trencher 12" and under; Welding Machines (2 through 5); Winches, 4 Small Electric Drill Winches.

Class 5. Oilers and Directional Boring Machine Locator.

Class 6. Field Mechanics and Field Welders

Class 7. Gradall and machines of like nature.

TRUCK DRIVER - BUILDING, HEAVY AND HIGHWAY CONSTRUCTION

Class 1. Two or three Axle Trucks. A-frame Truck when used for transportation purposes; Air Compressors and Welding Machines, including those pulled by cars, pick-up trucks and tractors; Ambulances; Batch Gate Lockers; Batch Hopperman; Car and Truck Washers; Carry-alls; Fork Lifts and Hoisters; Helpers; Mechanics Helpers and Greasers; Oil Distributors 2-man operation; Pavement Breakers; Pole Trailer, up to 40 feet; Power Mower Tractors; Self-propelled Chip Spreader; Skipman; Slurry Trucks, 2-man operation; Slurry Truck Conveyor Operation, 2 or 3 man; Teamsters; Unskilled dumpman; and Truck Drivers hauling warning lights, barricades, and portable toilets on the job site.

Class 2. Four axle trucks; Dump Crets and Adgetors under 7 yards; Dumpsters, Track Trucks, Euclids, Hug Bottom Dump Turnapulls or Turnatrailers when pulling other than self-loading equipment or similar equipment under 16 cubic yards; Mixer Trucks under 7 yards; Ready-mix Plant Hopper Operator, and Winch Trucks, 2 Axles.

Class 3. Five axle trucks; Dump Crets and Adgetors 7 yards and over; Dumpsters, Track Trucks, Euclids, Hug Bottom Dump Turnatrailers or turnapulls when pulling other than self-loading equipment or similar equipment over 16 cubic yards; Explosives and/or Fission Material Trucks; Mixer Trucks 7 yards or over; Mobile Cranes while in transit; Oil Distributors, 1-man operation; Pole Trailer, over 40 feet; Pole and Expandable Trailers hauling material over 50 feet long; Slurry trucks, 1-man operation; Winch trucks, 3 axles or more; Mechanic--Truck Welder and Truck Painter.

Class 4. Six axle trucks; Dual-purpose vehicles, such as mounted crane trucks with hoist and accessories; Foreman; Master Mechanic; Self-loading equipment like P.B. and trucks with scoops on the front.

Other Classifications of Work:

For definitions of classifications not otherwise set out, the Department generally has on file such definitions which are available. If a task to be performed is not subject to one of the classifications of pay set out, the Department will upon being contacted state which neighboring county has such a classification and provide such rate, such rate being deemed to exist by reference in this document. If no neighboring county rate applies to the task, the Department shall undertake a special determination, such special determination being then deemed to have existed under this determination. If a project requires these, or any classification not listed, please contact IDOL at 217-782-1710 for wage rates or clarifications.

LANDSCAPING

Landscaping work falls under the existing classifications for laborer, operating engineer and truck driver. The work performed by landscape plantsman and landscape laborer is covered by the existing classification of laborer. The work performed by landscape operators (regardless of equipment used or its size) is covered by the classifications of operating engineer. The work performed by landscape truck drivers (regardless of size of truck driven) is covered by the classifications of truck driver.

Whiteside County Prevailing Wage for February 2012

Trade Name	RG	TYP	C	Base	FRMAN	*M-F>8	OSA	OSH	H/W	Pensn	Vac	Trng
=====	==	===	=	=====	=====	=====	===	===	=====	=====	=====	=====
ASBESTOS ABT-GEN		BLD		29.400	30.400	1.5	1.5	2.0	8.040	12.02	0.000	0.800
ASBESTOS ABT-MEC		BLD		20.500	21.500	1.5	1.5	2.0	6.250	3.500	0.000	0.000
BOILERMAKER		BLD		34.170	37.170	2.0	2.0	2.0	6.820	8.550	0.000	0.350
BRICK MASON		BLD		35.710	38.460	1.5	1.5	2.0	7.400	11.73	0.000	0.570
CARPENTER		BLD		32.040	35.560	1.5	1.5	2.0	8.520	12.87	0.000	0.600
CARPENTER		HWY		32.440	34.190	1.5	1.5	2.0	9.250	11.99	0.000	0.490
CEMENT MASON		ALL		32.520	35.270	1.5	1.5	2.0	7.400	13.78	0.000	0.250
CERAMIC TILE FNSHER		BLD		32.240	0.000	1.5	1.5	2.0	7.400	4.840	0.000	0.500
COMMUNICATION TECH	E	BLD		36.000	39.600	1.5	1.5	2.0	9.740	11.20	0.000	0.720
ELECTRIC PWR EQMT OP		ALL		34.240	45.510	1.5	1.5	2.0	5.000	10.62	0.000	0.260
ELECTRIC PWR GRNDMAN		ALL		26.480	45.510	1.5	1.5	2.0	5.000	8.200	0.000	0.200
ELECTRIC PWR LINEMAN		ALL		41.000	45.510	1.5	1.5	2.0	5.000	12.71	0.000	0.310
ELECTRIC PWR TRK DRV		ALL		27.420	45.510	1.5	1.5	2.0	5.000	8.500	0.000	0.210
ELECTRICIAN	E	BLD		40.000	44.000	1.5	1.5	2.0	9.740	15.83	0.000	0.800
ELECTRICIAN	W	BLD		31.520	33.520	1.5	1.5	2.0	7.220	10.52	0.000	0.310
ELECTRONIC SYS TECH	W	BLD		23.500	25.250	1.5	1.5	2.0	7.020	5.150	0.000	0.310
ELEVATOR CONSTRUCTOR		BLD		39.140	44.030	2.0	2.0	2.0	11.03	11.96	2.350	0.000
GLAZIER		BLD		21.840	23.140	1.5	1.5	2.0	6.670	6.120	0.000	0.350
HT/FROST INSULATOR		BLD		28.860	30.060	1.5	1.5	2.0	5.250	12.05	0.000	0.800
IRON WORKER	E	ALL		35.000	36.750	2.0	2.0	2.0	8.000	19.59	0.000	0.950
IRON WORKER	W	ALL		27.500	29.700	1.5	1.5	2.0	8.890	10.18	0.000	0.620
LABORER		BLD		29.400	30.400	1.5	1.5	2.0	8.040	12.02	0.000	0.800
LABORER		HWY		30.100	30.850	1.5	1.5	2.0	8.040	12.02	0.000	0.800
LABORER, SKILLED		HWY		32.250	33.000	1.5	1.5	2.0	8.040	12.02	0.000	0.800
LATHER		BLD		32.040	35.560	1.5	1.5	2.0	8.520	12.87	0.000	0.600
MACHINIST		BLD		43.160	45.160	1.5	1.5	2.0	7.980	8.950	0.000	0.000
MARBLE FINISHERS		BLD		32.240	0.000	1.5	1.5	2.0	7.400	4.840	0.000	0.500
MARBLE MASON		BLD		35.090	35.340	1.5	1.5	2.0	7.400	6.980	0.000	0.540
MILLWRIGHT		BLD		34.400	37.840	1.5	1.5	2.0	7.100	11.94	0.000	0.500
OPERATING ENGINEER	E	BLD	1	40.350	44.350	2.0	2.0	2.0	14.55	9.300	2.350	1.300
OPERATING ENGINEER	E	BLD	2	39.650	44.350	2.0	2.0	2.0	14.55	9.300	2.350	1.300
OPERATING ENGINEER	E	BLD	3	37.200	44.350	2.0	2.0	2.0	14.55	9.300	2.350	1.300
OPERATING ENGINEER	E	BLD	4	35.200	44.350	2.0	2.0	2.0	14.55	9.300	2.350	1.300
OPERATING ENGINEER	E	BLD	5	44.100	44.350	2.0	2.0	2.0	14.55	9.300	2.350	1.300
OPERATING ENGINEER	E	BLD	6	43.350	44.350	2.0	2.0	2.0	14.55	9.300	2.350	1.300
OPERATING ENGINEER	E	BLD	7	40.350	44.350	2.0	2.0	2.0	14.55	9.300	2.350	1.300
OPERATING ENGINEER	E	HWY	1	40.200	44.200	1.5	1.5	2.0	14.55	9.300	2.350	1.300
OPERATING ENGINEER	E	HWY	2	39.650	44.200	1.5	1.5	2.0	14.55	9.300	2.350	1.300
OPERATING ENGINEER	E	HWY	3	38.350	44.200	1.5	1.5	2.0	14.55	9.300	2.350	1.300
OPERATING ENGINEER	E	HWY	4	36.900	44.200	1.5	1.5	2.0	14.55	9.300	2.350	1.300
OPERATING ENGINEER	E	HWY	5	35.450	44.200	1.5	1.5	2.0	14.55	9.300	2.350	1.300
OPERATING ENGINEER	E	HWY	6	43.200	44.200	1.5	1.5	2.0	14.55	9.300	2.350	1.300
OPERATING ENGINEER	E	HWY	7	41.200	44.200	1.5	1.5	2.0	14.55	9.300	2.350	1.300
OPERATING ENGINEER	W	BLD	1	29.400	30.400	1.5	1.5	2.0	13.95	6.600	1.500	0.800
OPERATING ENGINEER	W	BLD	2	27.800	30.400	1.5	1.5	2.0	13.95	6.600	1.500	0.800
OPERATING ENGINEER	W	BLD	3	26.650	30.400	1.5	1.5	2.0	13.95	6.600	1.500	0.800
OPERATING ENGINEER	W	BLD	4	29.650	30.650	1.5	1.5	2.0	13.95	6.600	1.500	0.800
OPERATING ENGINEER	W	BLD	5	30.150	31.150	1.5	1.5	2.0	13.95	6.600	1.500	0.800
OPERATING ENGINEER	W	BLD	6	30.650	31.650	1.5	1.5	2.0	13.95	6.600	1.500	0.800
OPERATING ENGINEER	W	BLD	7	30.400	31.400	1.5	1.5	2.0	13.95	6.600	1.500	0.800
OPERATING ENGINEER	W	HWY	1	29.400	30.400	1.5	1.5	2.0	13.95	6.600	1.500	0.800
OPERATING ENGINEER	W	HWY	2	27.800	30.400	1.5	1.5	2.0	13.95	6.600	1.500	0.800
OPERATING ENGINEER	W	HWY	3	26.650	30.400	1.5	1.5	2.0	13.95	6.600	1.500	0.800
OPERATING ENGINEER	W	HWY	4	29.650	30.650	1.5	1.5	2.0	13.95	6.600	1.500	0.800
OPERATING ENGINEER	W	HWY	5	30.150	31.150	1.5	1.5	2.0	13.95	6.600	1.500	0.800
OPERATING ENGINEER	W	HWY	6	30.650	31.650	1.5	1.5	2.0	13.95	6.600	1.500	0.800
OPERATING ENGINEER	W	HWY	7	29.900	30.900	1.5	1.5	2.0	13.95	6.600	1.500	0.800
OPERATING ENGINEER	W	HWY	8	30.400	31.400	1.5	1.5	2.0	13.95	6.600	1.500	0.800

PAINTER	ALL	26.820	27.820	1.5	1.5	1.5	5.000	6.100	0.000	0.600
PAINTER OVER 30FT	ALL	28.070	29.070	1.5	1.5	1.5	5.000	6.100	0.000	0.600
PAINTER PWR EQMT	ALL	27.320	28.320	1.5	1.5	1.5	5.000	6.100	0.000	0.600
PILEDRIVER	BLD	33.040	36.670	1.5	1.5	2.0	8.520	12.87	0.000	0.600
PILEDRIVER	HWY	32.440	34.190	1.5	1.5	2.0	9.250	11.99	0.000	0.490
PIPEFITTER	ALL	35.700	39.270	1.5	1.5	2.0	5.150	11.35	0.000	1.000
PLASTERER	BLD	33.360	36.700	2.0	2.0	2.0	7.650	11.05	0.000	0.250
PLUMBER	ALL	35.700	39.270	1.5	1.5	2.0	5.150	11.35	0.000	1.000
ROOFER	BLD	24.630	25.880	1.5	1.5	2.0	8.110	5.370	0.000	0.250
SHEETMETAL WORKER	BLD	35.450	37.380	1.5	1.5	2.0	5.250	14.77	0.520	0.290
SPRINKLER FITTER	BLD	36.140	38.890	1.5	1.5	2.0	8.100	8.200	0.000	0.350
STONE MASON	BLD	35.710	38.460	1.5	1.5	2.0	7.400	11.73	0.000	0.570
TERRAZZO FINISHER	BLD	32.240	0.000	1.5	1.5	2.0	7.400	4.840	0.000	0.500
TERRAZZO MASON	BLD	35.090	35.340	1.5	1.5	2.0	7.400	6.980	0.000	0.540
TILE LAYER	BLD	32.040	35.560	1.5	1.5	2.0	8.520	12.87	0.000	0.600
TILE MASON	BLD	35.090	35.340	1.5	1.5	2.0	7.400	6.980	0.000	0.540
TRUCK DRIVER	ALL 1	30.350	0.000	1.5	1.5	2.0	10.05	4.610	0.000	0.250
TRUCK DRIVER	ALL 2	30.790	0.000	1.5	1.5	2.0	10.05	4.610	0.000	0.250
TRUCK DRIVER	ALL 3	30.990	0.000	1.5	1.5	2.0	10.05	4.610	0.000	0.250
TRUCK DRIVER	ALL 4	31.270	0.000	1.5	1.5	2.0	10.05	4.610	0.000	0.250
TRUCK DRIVER	ALL 5	32.090	0.000	1.5	1.5	2.0	10.05	4.610	0.000	0.250
TRUCK DRIVER	O&C 1	24.280	0.000	1.5	1.5	2.0	10.05	4.610	0.000	0.250
TRUCK DRIVER	O&C 2	24.630	0.000	1.5	1.5	2.0	10.05	4.610	0.000	0.250
TRUCK DRIVER	O&C 3	24.790	0.000	1.5	1.5	2.0	10.05	4.610	0.000	0.250
TRUCK DRIVER	O&C 4	25.020	0.000	1.5	1.5	2.0	10.05	4.610	0.000	0.250
TRUCK DRIVER	O&C 5	25.670	0.000	1.5	1.5	2.0	10.05	4.610	0.000	0.250
TUCKPOINTER	BLD	35.710	38.460	1.5	1.5	2.0	7.400	11.73	0.000	0.570

Legend:

M-F>8 (Overtime is required for any hour greater than 8 worked each day, Monday through Friday.)

OSA (Overtime is required for every hour worked on Saturday)

OSH (Overtime is required for every hour worked on Sunday and Holidays)

H/W (Health & Welfare Insurance)

Pensn (Pension)

Vac (Vacation)

Trng (Training)

Explanations

WHITESIDE COUNTY

ELECTRICIAN AND COMMUNICATION TECHNICIAN(EAST) - Townships of Genessee, Jordan, Hopkins, Sterling, Hume, Montmorency, Tampico, and Hahnaman.

ELECTRONIC SYSTEMS TECHNICIAN (WEST) - Portion west of Genessee, Hume, Mount Pleasant, and Tampico Townships.

IRONWORKERS (EAST) - That part county North and East of a line from Fair Haven (Carroll County) to Rt. 30, then to the East county line.

OPERATING ENGINEERS (WEST) - From the fifth sectional line east of

Morrison, running directly north and south.

The following list is considered as those days for which holiday rates of wages for work performed apply: New Years Day, Memorial Day, Fourth of July, Labor Day, Thanksgiving Day, Christmas Day and Veterans Day in some classifications/counties. Generally, any of these holidays which fall on a Sunday is celebrated on the following Monday. This then makes work performed on that Monday payable at the appropriate overtime rate for holiday pay. Common practice in a given local may alter certain days of celebration. If in doubt, please check with IDOL.

Oil and chip resealing (O&C) means the application of road oils and liquid asphalt to coat an existing road surface, followed by application of aggregate chips or gravel to coated surface, and subsequent rolling of material to seal the surface.

EXPLANATION OF CLASSES

ASBESTOS - GENERAL - removal of asbestos material/mold and hazardous materials from any place in a building, including mechanical systems where those mechanical systems are to be removed. This includes the removal of asbestos materials/mold and hazardous materials from ductwork or pipes in a building when the building is to be demolished at the time or at some close future date.

ASBESTOS - MECHANICAL - removal of asbestos material from mechanical systems, such as pipes, ducts, and boilers, where the mechanical systems are to remain.

CERAMIC TILE FINISHER, MARBLE FINISHER, TERRAZZO FINISHER

Assisting, helping or supporting the tile, marble and terrazzo mechanic by performing their historic and traditional work assignments required to complete the proper installation of the work covered by said crafts. The term "Ceramic" is used for naming the classification only and is in no way a limitation of the product handled. Ceramic takes into consideration most hard tiles.

COMMUNICATIONS TECHNICIAN - East

Installing, manufacturing, assembling and maintaining sound and intercom, protection alarm (security), fire alarm, master antenna television, closed circuit television, low voltage control for computers and/or door monitoring, school communications systems, telephones and servicing of nurse and emergency calls, and the installation and maintenance of transmit and receive antennas, transmitters, receivers, and associated apparatus which operates in conjunction with above systems. All work associated with these system installations will be included EXCEPT the installation of protective metallic conduit in new construction projects (excluding less than ten-foot runs strictly for protection of cable) and 120 volt AC (or higher) power wiring and associated hardware.

ELECTRONIC SYSTEMS TECHNICIAN - West

Installing, assembling and maintaining sound and intercom, protection alarm (security), master antenna television, closed circuit television, computer hardware and software programming and installation to the network's outlet and input (EXCLUDING all cabling, power and cable termination work historically performed by wiremen), door monitoring and control, nurse and emergency call programming and installation to the system's outlet and input (EXCLUDING all

cabling, power and cable termination work historically performed by wiremen), clock and timing; and the installation and maintenance of transmit and receive antennas, transmitters, receivers, and associated apparatus which operates in conjunction with the above systems. All work associated with these system installations will be included EXCEPT (1) installation of protective metallic conduit, excluding less than ten-foot runs strictly for protection of cable, and (2) 120 volt AC (or higher) power wiring and associated hardware.

LABORER, SKILLED - HIGHWAY

Individuals engaged in the following types of work, irrespective of the site of the work: asbestos abatement worker, handling of any materials with any foreign matter harmful to skin or clothing, track laborer, cement handlers, chloride handlers, the unloading and loading with steel workers and re-bars, concrete workers wet, tunnel helpers in free air, batch dumpers, mason tenders, kettle and tar men, tank cleaners, plastic installers, scaffold workers, motorized buggies or motorized unit used for wet concrete or handling of building materials, laborers with de-watering systems, sewer workers plus depth, rod and chainmen with technical engineers, rod and chainmen with land surveyors, rod and chainmen with surveyors, vibrator operators, cement silica, clay, fly ash, lime and plasters, handlers (bulk or bag), cofferdam workers plus depth, on concrete paving, placing, cutting and tying of reinforcing, deck hand, dredge hand, and shore laborers, bankmen on floating plant, grade checker, power tools, front end man on chip spreaders, cession workers plus depth, gunnite nozzle men, lead man on sewer work, welders, cutters, burners and torchmen, chainsaw operators, jackhammer and drill operators, layout man and/or drainage tile layer, steel form setter - street and highway, air tamping hammermen, signal man on crane, concrete saw operator, screedman on asphalt pavers, laborers tending masons with hot material or where foreign materials are used, mortar mixer operators, multiple concrete duct - leadsman, lumen, asphalt raker, curb asphalt machine operator, ready mix scalemen (permanent, portable or temporary plant), laborers handling masterplate or similar materials, laser beam operator, concrete burning machine operator, coring machine operator, plaster tender, underpinning and shoring of buildings, pump men, manhole and catch basin, dirt and stone tamper, hose men on concrete pumps, hazardous waste worker, lead base paint abatement worker, lining of pipe, refusing machine, assisting on direct boring machine, the work of laying watermain, fire hydrants, all mechanical joints to watermain work, sewer worker, and tapping water service and forced lift station mechanical worker.

OPERATING ENGINEERS - BUILDING (East)

Class 1. Asphalt Plant; Asphalt Spreader; Autograde; Backhoes with Caisson Attachment; Batch Plant; Benoto (requires Two Engineers); Boiler and Throttle Valve; Caisson Rigs; Central Redi-Mix Plant; Combination Back Hoe Front End-loader Machine; Compressor and Throttle Valve; Concrete Breaker (Truck Mounted); Concrete Conveyor; Concrete Paver (over 27E cu. ft.): Concrete Paver (27 cu. ft. and under); Concrete Placer; Concrete Pump (Truck Mounted); Concrete Conveyor (Truck Mounted); Concrete Tower; Cranes, All; GCI and similar types (required two operators only); Cranes, Hammerhead; Creter Crane; Crusher, Stone, etc.; Derricks, All; Derricks, Traveling; Formless Curb and Gutter Machine; Grader, Elevating; Grouting Machines; Highlift Shovels or Front Endloader 2-1/4 yd. and over; Hoists, Elevators, outside type rack and pinion and similar machines; Hoists, one, two and three Drum; Hoists, Two Tugger One Floor; Hydraulic Backhoes; Hydraulic Boom Trucks; Locomotives, All; Lubrication Technician; Manipulators; Motor Patrol; Pile Drivers and Skid Rig;

Post Hole Digger; Pre-Stress Machine; Pump Cretes Dual Ram; Pump Cretes: Squeeze Cretes - Screw Type Pumps, Gypsum Bulker and Pump; Raised and Blind Hole Drill; Rock Drill (self-propelled); Rock Drill - Truck Mounted; Roto Mill Grinder; Scoops - Tractor Drawn; Slipform Paver; Scrapers Prime Movers; Straddle Buggies; Tie Back Machine; Tractor with Boom and Side Boom; Trenching Machines.

Class 2. Bobcat (over 3/4 cu. yd.); Boilers; Brick Forklift; Broom, All Power Propelled; Bulldozers; Concrete Mixer (Two Bag and Over); Conveyor, Portable; Forklift Trucks; Highlift Shovels or Front Endloaders under 2-1/4 yd.; Hoists, Automatic; Hoists, Sewer Dragging Machine; Hoists, Tugger Single Drum; Rollers, All; Steam Generators; Tractors, All; Tractor Drawn Vibratory Roller; Winch Trucks with "A" Frame.

Class 3. Air Compressor; Asphalt Spreader; Combination - Small Equipment Operator; Generators; Heaters, Mechanical; Hoists, Inside Elevators - (Rheostat Manual Controlled); Hydraulic Power Units (Pile Driving and Extracting); Pumps, Over 3" (1 to 3 not to exceed total of 300 ft.); Pumps, Well Points; Welding Machines (2 through 5); Winches, 4 Small Electric Drill Winches; Bobcat (up to and including 3/4 cu. yd.).

Class 4. Elevator push button with automatic doors; Hoists, Inside; Oilers; Brick Forklift.

Class 5. Assistant Craft Foreman

Class 6. Mechanics

Class 7. Gradall

OPERATING ENGINEERS - HIGHWAY CONSTRUCTION (East)

Class 1. Asphalt Plant; Asphalt Heater and Planer Combination; Asphalt Heater Scarfire; Asphalt Silo Tender; Asphalt Spreader; Autograder; ABG Paver; Backhoes with Caisson Attachment; Ballast Regulator; Belt Loader; Caisson Rigs; Car Dumper; Central Redi-Mix Plant; Backhoe w/shear attachments; Combination Backhoe Front Endloader Machine, (1 cu. yd. Backhoe Bucket or over or with attachments); Concrete Breaker (Truck Mounted); Concrete Conveyor; Concrete Paver over 27E cu. ft.; Concrete Placer; Concrete Tube Float; Cranes, all attachments; Cranes, Tower of all types; Creter Crane; Crusher, Stone, etc.; Derricks, All; Derrick Boats; Derricks, Traveling; Directional Boring Machine over 12"; Dredges; Formless Curb and Gutter Machine; Grader, Elevating; Grader, Motor Grader, Motor Patrol, Auto Patrol, Form Grader, Pull Grader, Subgrader; Guard Rail Post Driver Mounted; Hoists, One, Two and Three Drum; Hydraulic Backhoes; Lubrication Technician; Manipulators; Pile Drivers and Skid Rig; Pre-Stress Machine; Pump Cretes Dual Ram; Rock Drill - Crawler or Skid Rig; Rock Drill - Truck Mounted; Rock/Track Tamper; Roto Mill Grinder; Slip-Form Paver; Soil Test Drill Rig (Truck Mounted); Straddle Buggies; GCI Crane; Hydraulic Telescoping Form (Tunnel); Tie Back Machine; Tractor Drawn Belt Loader; Tractor Drawn Belt Loader with attached pusher; Tractor with Boom; Tractaire with Attachments; Traffic Barrier Conveyor Machine; Raised or Blind Hole Drills; Trenching Machine (over 12"); Truck Mounted Concrete Pump with Boom; Truck Mounted Concrete Conveyor; Underground Boring and/or Mining Machines; Wheel Excavator; Widener (APSCO).

Class 2. Batch Plant; Bituminous Mixer; Boiler and Throttle Valve; Bulldozers; Car Loader Trailing Conveyors; Combination Backhoe Front

Endloader Machine (less than 1 cu. yd. Backhoe Bucket or over or with attachments); Compressor and Throttle Valve; Compressor, Common Receiver (3); Concrete Breaker or Hydro Hammer; Concrete Grinding Machine; Concrete Mixer or Paver 7S Series to and including 27 cu. ft.; Concrete Spreader; Concrete Curing Machine, Burlap Machine, Belting Machine and Sealing Machine; Conveyor Muck Cars (Haglund or Similar Type); Drills, all; Finishing Machine - Concrete; Highlift Shovels or Front Endloader; Hoist - Sewer Dragging Machine; Hydraulic Boom Trucks (All Attachments); Hydro Blaster; All Locomotives, Dinky; Off-Road Hauling Units (including articulating) / 2 ton capacity or more; Non-Self Loading Ejection Dump; Pump Cretes: Squeeze Cretes - Screw Type Pumps, Gypsum Bulker and Pump; Roller, Asphalt; Rotary Snow Plows; Rototiller, Seaman, etc., self-propelled; Scoops - Tractor Drawn; Self-Propelled Compactor; Spreader - Chip - Stone, etc.; Scraper; Scraper - Prime Mover in Tandem (Regardless of Size); Tank Car Heater; Tractors, Push, Pulling Sheeps Foot, Disc, Compactor, etc.; Tug Boats.

Class 3. Boilers; Brooms, All Power Propelled; Cement Supply Tender; Compressor, Common Receiver (2); Concrete Mixer (Two Bag and Over); Conveyor, Portable; Farm-Type Tractors Used for Mowing, Seeding, etc.; Fireman on Boilers; Forklift Trucks; Grouting Machine; Hoists, Automatic; Hoists, All Elevators; Hoists, Tugger Single Drum; Jeep Diggers; Low Boys; Pipe Jacking Machines; Post-Hole Digger; Power Saw, Concrete Power Driven; Pug Mills; Rollers, other than asphalt; Seed and Straw Blower; Steam Generators; Stump Machine; Winch Trucks with "A" Frame; Work Boats; Tamper - Form - Motor Driven.

Class 4. Air Compressor - Small and Large; Asphalt Spreader, Backend Man; Bobcat (Skid Steer) all; Brick Forklift; Combination - Small Equipment Operator; Directional Boring Machine up to 12"; Generators; Heaters, Mechanical; Hydraulic Power Unit (Pile Driving, Extracting, or Drilling); Hydro-Blaster; Light Plants, All (1 through 5); Pumps, over 3" (1 to 3 not to exceed a total of 300 ft.); Pumps, Well Points; Tractaire; Trencher 12" and under; Welding Machines (2 through 5); Winches, 4 Small Electric Drill Winches.

Class 5. Oilers and Directional Boring Machine Locator.

Class 6. Field Mechanics and Field Welders

Class 7. Gradall and machines of like nature.

OPERATING ENGINEERS - BUILDING (West)

Class 1. Shovel; Concrete Spreader; Dipper Dredge Operator; Dipper Dredge Crane man; Dual Purpose Truck (boom, Boom, Winch, etc.); Mechanic-Welder; Pile Driver; Boom Tractor or Side Boom; Trenching Machine (40 H.P. and over); Building Hoist (1, 2 or 3 drums); Cleaning and Priming Machine; Backfiller (throw bucket); Locomotive Engineer; Concrete Paver; Slip Form Paver; Caisson Augering Machines; Mucking Machine; Asphalt Heater-Planer Unit; Laser Screed; Pug Mill; Concrete Conveyor or Pump; Mechanical loaded Log Chippers or similar machines; Group Equipment Greaser; Off-Road Haul Units; Pipe Bending; Automatic Curbing Machines; Blastholer; Self-Propelled Rotary Drill or similar machines; Work Boat; Combination Concrete Finishing Machine and Float; Asphalt Paver Screed Operator; Forklift (6,000 lb. cap. or over or working heights 28 ft. and above); Chip Spreader; Straddle Carrier; Asphalt Paver; Asphalt Plant Operator; Boring Machine (Directional, Vertical, or Horizontal); Central Redi-Mix Plant Operator; Combination Backhoe Front End loader; Concrete Breaker or Hydro-Hammer (excluding walk-behinds); Concrete Wheel Saw (Large self-propelled - excluding walk-behinds); Crusher (Stone, Concrete, Asphalt, etc.);

Curing-Tinning Machine; Excavator; Farm-type Tractor Operating Scoop or Scraper or with Power Attachment; Grader; Motor Grader; Motor Patrol; Auto Grader; Form Grader; Pull Grader; Sub Grader; Elevating Grader; Guard Rail Post Driver; Hoists; Hydraulic Dredge Leverman or Engineer; Hydro-Vac truck mounted or pull type (excluding hose work), and similar equipment; Loader (Track, Rubber Tire, or Articulated); Milling Machine (excluding walk-behinds); Road Widener-Shoulder Spreader; Scraper (Self-Propelled); Self-Propelled Roller or Tire Roller (on asphalt or Blacktop); Sheep Foot or Pad Foot Compactor (excluding walk-behinds); Steel Track-Type Tractor (Dozer, Push Cat, etc.); Transfer or Shuttle Buggy (excluding motorized wheel barrows and Georgia buggies).

Class 2. Asphalt Booster; Fireman and Pump Operator at Asphalt Plant; Mud Jack; Distributor; Self-propelled Roller (other than provided for in Class I); Pump Operator (more than one well-point pump); Trench Machine (under 40 H.P.); Forklift (less than 6,000 lb. cap. or working heights below 28 ft.); Gypsum Pump; Conveyor over 20 H.P.; Light Plant; Boiler (Engineer or Fireman); Mechanical Broom; Driver on Truck Crane or similar machines; Elevator (Permanent inside or Temporary outside); Farm-Type Tractor (without Power Attachment); Grout Pump (excluding hose work).

Class 3. Skid Loader; Oiler; Mechanic's Helper; Mechanical Heater (other than steam boiler); Small Outboard Motor Boat (Safety Boat and Life Boat); Engine Driven Welding Machine; Water Pumps; Air Compressor (400 c.f.m. or over); Deck Engineers.

Class 4. Leadman - Mechanic or Equipment Greaser.

Class 5. Track Excavator with Bucket (4 cubic yard and up to but not including 6 cubic yard).

Class 6. Track Excavator with Bucket (6 cubic yard and over).

Class 7. Crane (Friction or Hydraulic, regardless of size or attachments); Tow or Push Boat.

OPERATING ENGINEERS- HIGHWAY (West)

Class 1. Shovel; Concrete Spreader; Dipper Dredge Operator; Dipper Dredge Crane man; Dual Purpose Truck (Boom, Winch, etc.); Mechanic-Welder; Pile Driver; Boom Tractor or Side Boom; Building Hoist (1, 2 or 3 drums); Cleaning and Priming Machine; Backfiller (throw bucket); Locomotive Engineer; Concrete Paver; Slip Form Paver; Caisson Augering Machines; Mucking Machine; Asphalt Heater Planer Unit; Laser Screed; Pug Mill; Concrete Conveyor or Pump (excluding truck-mounted); Mechanical loaded Log Chippers or similar machines; Group Equipment Greaser; off-road haul units; Pipe Bending; Automatic Curbing Machines; Blastholer; Self-propelled Rotary Drill or similar machines; Work Boat; Combination Concrete Finishing Machine and Float; Asphalt Paver Screed Operator; Forklift (6,000 lb. cap. or over or working heights above 28 ft.); Chip Spreader; Asphalt Paver; Asphalt Plant Operator; Boring Machine (Directional, Vertical, or Horizontal); Central Redi-Mix Plant Operator; Combination Backhoe Front End loader; Concrete Breaker or Hydro-Hammer (excluding walk-behinds); Concrete Wheel Saw (Large self-propelled - excluding walk-behinds); Crusher (Stone, Concrete, Asphalt, etc.); Curing-Tinning Machine; Excavator; Farm-Type Tractor Operating Scoop or Scraper with Power Attachment; Grader; Motor Grader; Motor Patrol; Auto Grader; Form Grader; Pull Grader; Sub Grader; Elevating Grader; Guard Rail Post Driver; Hoists; Hydraulic Dredge Leverman or Engineer; Hydro-Vac truck

mounted or pull type, and similar equipment; Loader (Track, Rubber Tire, or Articulated); Milling Machine (excluding walk-behinds); Road Widener-Shoulder Spreader; Scraper (self-propelled); Self-propelled Roller or Tire Roller (on asphalt or Blacktop); Sheep Foot or Pad Foot Compactor (excluding walk-behinds); Steel Track-Type Tractor (Dozer, Push Cat, etc.); Transfer or Shuttle Buggy (excluding motorized wheel barrows and Georgia buggies); Trenching Machine (40 H.P. and over).

Class 2. Asphalt Booster; Fireman and Pump Operator at Asphalt Plant; Mud Jack; Farm-Type Tractor without Power attachment; Distributor; Straddle Carrier; Self-propelled Roller or Compactor (other than provided for in Class I); Pump Operator (more than one well-point pump); Trench Machine (under 40 H.P.); Forklift (less than 6,000 lb. capacity or working heights below 28 ft.); Conveyor over 20 H.P.; Air Compressor (400 c.f.m. or over); Light Plant; Boiler (Engineer or Fireman); Mechanical Broom; Driver on Truck Crane or similar machines; Elevator (Permanent inside or Temporary outside); Grout Pump (excluding hose work).

Class 3. Oiler; Mechanic's Helper; Mechanical Heater (other than steam boiler); Small Outboard Motor Boat (Safety Boat and Life Boat); Engine Driven Welding Machine; skid steer.

Class 4. Leadman - Mechanic or Equipment Greaser.

Class 5. Track Excavator with Bucket (4 cubic yard and up to but not including 6 cubic yard).

Class 6. Track Excavator with Bucket (6 cubic yard and over).

Class 7. Truck mounted Concrete Conveyor or Pumps Extending to 90 ft. or more.

Class 8. Crane (Friction or Hydraulic, regardless of size or attachments); Tow or Push Boat.

TRUCK DRIVER - BUILDING, HEAVY AND HIGHWAY CONSTRUCTION

Class 1. Drivers on 2 axle trucks hauling less than 9 ton. Air compressor and welding machines and brooms, including those pulled by separate units, truck driver helpers, warehouse employees, mechanic helpers, greasers and tiremen, pickup trucks when hauling materials, tools, or workers to and from and on-the-job site, and fork lifts up to 6,000 lb. capacity.

Class 2. Two or three axle trucks hauling more than 9 ton but hauling less than 16 ton. A-frame winch trucks, hydrolift trucks, vector trucks or similar equipment when used for transportation purposes. Fork lifts over 6,000 lb. capacity, winch trucks, four axle combination units, and ticket writers.

Class 3. Two, three or four axle trucks hauling 16 ton or more. Drivers on water pulls, articulated dump trucks, mechanics and working forepersons, and dispatchers. Five axle or more combination units.

Class 4. Low Boy and Oil Distributors.

Class 5. Drivers who require special protective clothing while employed on hazardous waste work.

TRUCK DRIVER - OIL AND CHIP RESEALING ONLY.

This shall encompass laborers, workers and mechanics who drive contractor or subcontractor owned, leased, or hired pickup, dump, service, or oil distributor trucks. The work includes transporting materials and equipment (including but not limited to, oils, aggregate supplies, parts, machinery and tools) to or from the job site; distributing oil or liquid asphalt and aggregate; stock piling material when in connection with the actual oil and chip contract. The Truck Driver (Oil & Chip Resealing) wage classification does not include supplier delivered materials.

Other Classifications of Work:

For definitions of classifications not otherwise set out, the Department generally has on file such definitions which are available. If a task to be performed is not subject to one of the classifications of pay set out, the Department will upon being contacted state which neighboring county has such a classification and provide such rate, such rate being deemed to exist by reference in this document. If no neighboring county rate applies to the task, the Department shall undertake a special determination, such special determination being then deemed to have existed under this determination. If a project requires these, or any classification not listed, please contact IDOL at 217-782-1710 for wage rates or clarifications.

LANDSCAPING

Landscaping work falls under the existing classifications for laborer, operating engineer and truck driver. The work performed by landscape plantsman and landscape laborer is covered by the existing classification of laborer. The work performed by landscape operators (regardless of equipment used or its size) is covered by the classifications of operating engineer. The work performed by landscape truck drivers (regardless of size of truck driven) is covered by the classifications of truck driver.

Winnebago County Prevailing Wage for February 2012

Trade Name	RG	TYP	C	Base	FRMAN	*M-F>8	OSA	OSH	H/W	Pensn	Vac	Trng
=====	==	===	=	=====	=====	=====	===	===	=====	=====	=====	=====
ASBESTOS ABT-GEN		BLD		29.460	30.460	1.5	1.5	2.0	8.040	11.89	0.000	0.800
ASBESTOS ABT-MEC		BLD		18.950	0.000	1.5	1.5	2.0	2.700	3.350	0.000	0.000
BOILERMAKER		BLD		43.450	47.360	2.0	2.0	2.0	6.970	12.61	0.000	0.350
BRICK MASON		BLD		35.710	38.460	1.5	1.5	2.0	7.400	11.73	0.000	0.570
CARPENTER		BLD		36.320	40.320	1.5	1.5	2.0	7.400	10.95	0.000	0.600
CARPENTER		HWY		37.280	39.030	1.5	1.5	2.0	7.400	9.000	0.000	0.490
CEMENT MASON		ALL		34.820	37.570	1.5	1.5	2.0	7.650	11.45	0.000	0.250
CERAMIC TILE FNSHER		BLD		32.240	0.000	1.5	1.5	2.0	7.400	4.840	0.000	0.500
COMMUNICATION TECH		BLD		36.000	39.600	1.5	1.5	2.0	9.740	11.20	0.000	0.720
ELECTRIC PWR EQMT OP		ALL		34.240	45.510	1.5	1.5	2.0	5.000	10.62	0.000	0.260
ELECTRIC PWR GRNDMAN		ALL		26.480	45.510	1.5	1.5	2.0	5.000	8.200	0.000	0.200
ELECTRIC PWR LINEMAN		ALL		41.000	45.510	1.5	1.5	2.0	5.000	12.71	0.000	0.310
ELECTRIC PWR TRK DRV		ALL		27.420	45.510	1.5	1.5	2.0	5.000	8.500	0.000	0.210
ELECTRICIAN		BLD		40.000	44.000	1.5	1.5	2.0	9.740	15.83	0.000	0.800
ELEVATOR CONSTRUCTOR		BLD		44.940	50.560	2.0	2.0	2.0	11.03	11.96	2.760	0.000
GLAZIER		BLD		32.730	33.730	1.5	1.5	2.0	8.950	8.200	0.000	1.250
HT/FROST INSULATOR		BLD		33.280	35.770	1.5	1.5	2.0	7.450	14.32	0.000	0.000
IRON WORKER		ALL		35.000	36.750	2.0	2.0	2.0	8.000	19.59	0.000	0.950
LABORER		BLD		29.460	30.460	1.5	1.5	2.0	8.040	11.89	0.000	0.800
LABORER		HWY		30.160	30.910	1.5	1.5	2.0	8.040	11.89	0.000	0.800
LABORER, SKILLED		HWY		32.310	33.060	1.5	1.5	2.0	8.040	11.89	0.000	0.800
LATHER		BLD		36.320	40.320	1.5	1.5	2.0	7.400	10.95	0.000	0.600
MACHINIST		BLD		43.160	45.160	1.5	1.5	2.0	7.980	8.950	0.000	0.000
MARBLE FINISHERS		BLD		32.240	0.000	1.5	1.5	2.0	7.400	4.840	0.000	0.500
MARBLE MASON		BLD		35.090	35.340	1.5	1.5	2.0	7.400	6.980	0.000	0.540
MATERIAL TESTER I		ALL		21.550	0.000	1.5	1.5	2.0	7.460	4.840	0.000	0.170
MATERIALS TESTER II		ALL		26.550	0.000	1.5	1.5	2.0	7.460	4.840	0.000	0.170
MILLWRIGHT		BLD		33.970	37.370	1.5	1.5	2.0	6.550	12.35	0.000	0.500
OPERATING ENGINEER		BLD	1	40.350	44.350	2.0	2.0	2.0	14.55	9.300	2.350	1.300
OPERATING ENGINEER		BLD	2	39.650	44.350	2.0	2.0	2.0	14.55	9.300	2.350	1.300
OPERATING ENGINEER		BLD	3	37.200	44.350	2.0	2.0	2.0	14.55	9.300	2.350	1.300
OPERATING ENGINEER		BLD	4	35.200	44.350	2.0	2.0	2.0	14.55	9.300	2.350	1.300
OPERATING ENGINEER		BLD	5	44.100	44.350	2.0	2.0	2.0	14.55	9.300	2.350	1.300
OPERATING ENGINEER		BLD	6	43.350	44.350	2.0	2.0	2.0	14.55	9.300	2.350	1.300
OPERATING ENGINEER		BLD	7	40.350	44.350	2.0	2.0	2.0	14.55	9.300	2.350	1.300
OPERATING ENGINEER		HWY	1	40.200	44.200	1.5	1.5	2.0	14.55	9.300	2.350	1.300
OPERATING ENGINEER		HWY	2	39.650	44.200	1.5	1.5	2.0	14.55	9.300	2.350	1.300
OPERATING ENGINEER		HWY	3	38.350	44.200	1.5	1.5	2.0	14.55	9.300	2.350	1.300
OPERATING ENGINEER		HWY	4	36.900	44.200	1.5	1.5	2.0	14.55	9.300	2.350	1.300
OPERATING ENGINEER		HWY	5	35.450	44.200	1.5	1.5	2.0	14.55	9.300	2.350	1.300
OPERATING ENGINEER		HWY	6	43.200	44.200	1.5	1.5	2.0	14.55	9.300	2.350	1.300
OPERATING ENGINEER		HWY	7	41.200	44.200	1.5	1.5	2.0	14.55	9.300	2.350	1.300
PAINTER		ALL		35.000	37.000	1.5	1.5	1.5	8.950	8.200	0.000	1.250
PILEDRIVER		BLD		37.320	41.430	1.5	1.5	2.0	7.400	10.95	0.000	0.600
PILEDRIVER		HWY		37.280	39.030	1.5	1.5	2.0	7.400	9.000	0.000	0.490
PIPEFITTER		BLD		39.250	42.000	1.5	1.5	2.0	7.980	10.59	0.000	0.950
PLASTERER		BLD		33.360	36.700	1.5	1.5	2.0	7.650	11.05	0.000	0.250
PLUMBER		BLD		39.250	42.000	1.5	1.5	2.0	7.980	10.59	0.000	0.950
ROOFER		BLD		37.650	40.650	1.5	1.5	2.0	7.750	6.570	0.000	0.430
SHEETMETAL WORKER		BLD		35.450	37.380	1.5	1.5	2.0	5.250	14.77	0.520	0.290
SPRINKLER FITTER		BLD		36.140	38.890	1.5	1.5	2.0	8.100	8.200	0.000	0.350
STONE MASON		BLD		35.710	38.460	1.5	1.5	2.0	7.400	11.73	0.000	0.570
TERRAZZO FINISHER		BLD		32.240	0.000	1.5	1.5	2.0	7.400	4.840	0.000	0.500
TERRAZZO MASON		BLD		35.090	35.340	1.5	1.5	2.0	7.400	6.980	0.000	0.540
TILE LAYER		BLD		36.320	40.320	1.5	1.5	2.0	7.400	10.95	0.000	0.600
TILE MASON		BLD		35.090	35.340	1.5	1.5	2.0	7.400	6.980	0.000	0.540
TRUCK DRIVER		ALL	1	32.960	33.420	1.5	1.5	2.0	6.900	8.220	0.000	0.000
TRUCK DRIVER		ALL	2	33.110	33.420	1.5	1.5	2.0	6.900	8.220	0.000	0.000

TRUCK DRIVER	ALL	3	33.310	33.420	1.5	1.5	2.0	6.900	8.220	0.000	0.000
TRUCK DRIVER	ALL	4	33.420	33.420	1.5	1.5	2.0	6.900	8.220	0.000	0.000
TUCKPOINTER	BLD		35.710	38.460	1.5	1.5	2.0	7.400	11.73	0.000	0.570

Legend:

M-F>8 (Overtime is required for any hour greater than 8 worked each day, Monday through Friday.)

OSA (Overtime is required for every hour worked on Saturday)

OSH (Overtime is required for every hour worked on Sunday and Holidays)

H/W (Health & Welfare Insurance)

Pensn (Pension)

Vac (Vacation)

Trng (Training)

Explanations

WINNEBAGO COUNTY

The following list is considered as those days for which holiday rates of wages for work performed apply: New Years Day, Memorial Day, Fourth of July, Labor Day, Thanksgiving Day, Christmas Day and Veterans Day in some classifications/counties. Generally, any of these holidays which fall on a Sunday is celebrated on the following Monday. This then makes work performed on that Monday payable at the appropriate overtime rate for holiday pay. Common practice in a given local may alter certain days of celebration. If in doubt, please check with IDOL.

EXPLANATION OF CLASSES

ASBESTOS - GENERAL - removal of asbestos material/mold and hazardous materials from any place in a building, including mechanical systems where those mechanical systems are to be removed. This includes the removal of asbestos materials/mold and hazardous materials from ductwork or pipes in a building when the building is to be demolished at the time or at some close future date.

ASBESTOS - MECHANICAL - removal of asbestos material from mechanical systems, such as pipes, ducts, and boilers, where the mechanical systems are to remain.

CERAMIC TILE FINISHER, MARBLE FINISHER, TERRAZZO FINISHER

Assisting, helping or supporting the tile, marble and terrazzo mechanic by performing their historic and traditional work assignments required to complete the proper installation of the work covered by said crafts. The term "Ceramic" is used for naming the classification only and is in no way a limitation of the product handled. Ceramic takes into consideration most hard tiles.

COMMUNICATIONS TECHNICIAN

Installing, manufacturing, assembling and maintaining sound and

intercom, protection alarm (security), fire alarm, master antenna television, closed circuit television, low voltage control for computers and/or door monitoring, school communications systems, telephones and servicing of nurse and emergency calls, and the installation and maintenance of transmit and receive antennas, transmitters, receivers, and associated apparatus which operates in conjunction with above systems. All work associated with these system installations will be included EXCEPT the installation of protective metallic conduit in new construction projects (excluding less than ten-foot, runs strictly for protection of cable) and 120 volt AC (or higher) power wiring and associated hardware.

LABORER, SKILLED - HIGHWAY

Individuals engaged in the following types of work, irrespective of the site of the work: asbestos abatement worker, handling of any materials with any foreign matter harmful to skin or clothing, track laborer, cement handlers, chloride handlers, the unloading and loading with steel workers and re-bars, concrete workers wet, tunnel helpers in free air, batch dumpers, mason tenders, kettle and tar men, tank cleaners, plastic installers, scaffold workers, motorized buggies or motorized unit used for wet concrete or handling of building materials, laborers with de-watering systems, sewer workers plus depth, rod and chainmen with technical engineers, rod and chainmen with land surveyors, rod and chainmen with surveyors, vibrator operators, cement silica, clay, fly ash, lime and plasters, handlers (bulk or bag), cofferdam workers plus depth, on concrete paving, placing, cutting and tying of reinforcing, deck hand, dredge hand, and shore laborers, bankmen on floating plant, grade checker, power tools, front end man on chip spreaders, cession workers plus depth, gunnite nozzle men, lead man on sewer work, welders, cutters, burners and torchmen, chainsaw operators, jackhammer and drill operators, layout man and/or drainage tile layer, steel form setter - street and highway, air tamping hammermen, signal man on crane, concrete saw operator, screedman on asphalt pavers, laborers tending masons with hot material or where foreign materials are used, mortar mixer operators, multiple concrete duct - leadsman, lumen, asphalt raker, curb asphalt machine operator, ready mix scalemen (permanent, portable or temporary plant), laborers handling masterplate or similar materials, laser beam operator, concrete burning machine operator, coring machine operator, plaster tender, underpinning and shoring of buildings, pump men, manhole and catch basin, dirt and stone tamper, hose men on concrete pumps, hazardous waste worker, lead base paint abatement worker, lining of pipe, refusing machine, assisting on direct boring machine, the work of laying watermain, fire hydrants, all mechanical joints to watermain work, sewer worker, and tapping water service and forced lift station mechanical worker.

MATERIAL TESTER I: Hand coring and drilling for testing of materials; field inspection of uncured concrete and asphalt.

MATERIAL TESTER II: Field inspection of welds, structural steel, fireproofing, masonry, soil, facade, reinforcing steel, formwork, cured concrete, and concrete and asphalt batch plants; adjusting proportions of bituminous mixtures.

OPERATING ENGINEERS - BUILDING

Class 1. Asphalt Plant; Asphalt Spreader; Autograde; Backhoes with Caisson Attachment; Batch Plant; Benoto (requires Two Engineers);

Boiler and Throttle Valve; Caisson Rigs; Central Redi-Mix Plant; Combination Back Hoe Front End-loader Machine; Compressor and Throttle Valve; Concrete Breaker (Truck Mounted); Concrete Conveyor; Concrete Paver (over 27E cu. ft.): Concrete Paver (27 cu. ft. and under); Concrete Placer; Concrete Pump (Truck Mounted); Concrete Conveyor (Truck Mounted); Concrete Tower; Cranes, All; GCI and similar types (required two operators only); Cranes, Hammerhead; Creter Crane; Crusher, Stone, etc.; Derricks, All; Derricks, Traveling; Formless Curb and Gutter Machine; Grader, Elevating; Grouting Machines; Highlift Shovels or Front Endloader 2-1/4 yd. and over; Hoists, Elevators, outside type rack and pinion and similar machines; Hoists, one, two and three Drum; Hoists, Two Tugger One Floor; Hydraulic Backhoes; Hydraulic Boom Trucks; Locomotives, All; Lubrication Technician; Manipulators; Motor Patrol; Pile Drivers and Skid Rig; Post Hole Digger; Pre-Stress Machine; Pump Cretes Dual Ram; Pump Cretes: Squeeze Cretes - Screw Type Pumps, Gypsum Bulker and Pump; Raised and Blind Hole Drill; Rock Drill (self-propelled); Rock Drill - Truck Mounted; Roto Mill Grinder; Scoops - Tractor Drawn; Slipform Paver; Scrapers Prime Movers; Straddle Buggies; Tie Back Machine; Tractor with Boom and Side Boom; Trenching Machines.

Class 2. Bobcat (over 3/4 cu. yd.); Boilers; Brick Forklift; Broom, All Power Propelled; Bulldozers; Concrete Mixer (Two Bag and Over); Conveyor, Portable; Forklift Trucks; Highlift Shovels or Front Endloaders under 2-1/4 yd.; Hoists, Automatic; Hoists, Sewer Dragging Machine; Hoists, Tugger Single Drum; Rollers, All; Steam Generators; Tractors, All; Tractor Drawn Vibratory Roller; Winch Trucks with "A" Frame.

Class 3. Air Compressor; Asphalt Spreader; Combination - Small Equipment Operator; Generators; Heaters, Mechanical; Hoists, Inside Elevators - (Rheostat Manual Controlled); Hydraulic Power Units (Pile Driving and Extracting); Pumps, Over 3" (1 to 3 not to exceed total of 300 ft.); Pumps, Well Points; Welding Machines (2 through 5); Winches, 4 Small Electric Drill Winches; Bobcat (up to and including 3/4 cu. yd.).

Class 4. Elevator push button with automatic doors; Hoists, Inside; Oilers; Brick Forklift.

Class 5. Assistant Craft Foreman

Class 6. Mechanics

Class 7. Gradall.

OPERATING ENGINEERS - HIGHWAY CONSTRUCTION

Class 1. Asphalt Plant; Asphalt Heater and Planer Combination; Asphalt Heater Scarfire; Asphalt Silo Tender; Asphalt Spreader; Autograder; ABG Paver; Backhoes with Caisson Attachment; Ballast Regulator; Belt Loader; Caisson Rigs; Car Dumper; Central Redi-Mix Plant; Backhoe w/shear attachments; Combination Backhoe Front Endloader Machine, (1 cu. yd. Backhoe Bucket or over or with attachments); Concrete Breaker (Truck Mounted); Concrete Conveyor; Concrete Paver over 27E cu. ft.; Concrete Placer; Concrete Tube Float; Cranes, all attachments; Cranes, Tower of all types; Creter Crane; Crusher, Stone, etc.; Derricks, All; Derrick Boats; Derricks, Traveling; Directional Boring Machine over 12"; Dredges; Formless Curb and Gutter Machine; Grader, Elevating; Grader, Motor Grader, Motor Patrol, Auto Patrol, Form Grader, Pull Grader, Subgrader; Guard Rail Post Driver Mounted; Hoists, One, Two and Three Drum; Hydraulic Backhoes; Lubrication

Technician; Manipulators; Pile Drivers and Skid Rig; Pre-Stress Machine; Pump Cretes Dual Ram; Rock Drill - Crawler or Skid Rig; Rock Drill - Truck Mounted; Rock/Track Tamper; Roto Mill Grinder; Slip-Form Paver; Soil Test Drill Rig (Truck Mounted); Straddle Buggies; GCI Crane; Hydraulic Telescoping Form (Tunnel); Tie Back Machine; Tractor Drawn Belt Loader; Tractor Drawn Belt Loader with attached pusher; Tractor with Boom; Tractaire with Attachments; Traffic Barrier Conveyor Machine; Raised or Blind Hole Drills; Trenching Machine (over 12"); Truck Mounted Concrete Pump with Boom; Truck Mounted Concrete Conveyor; Underground Boring and/or Mining Machines; Wheel Excavator; Widener (APSCO).

Class 2. Batch Plant; Bituminous Mixer; Boiler and Throttle Valve; Bulldozers; Car Loader Trailing Conveyors; Combination Backhoe Front Endloader Machine (less than 1 cu. yd. Backhoe Bucket or over or with attachments); Compressor and Throttle Valve; Compressor, Common Receiver (3); Concrete Breaker or Hydro Hammer; Concrete Grinding Machine; Concrete Mixer or Paver 7S Series to and including 27 cu. ft.; Concrete Spreader; Concrete Curing Machine, Burlap Machine, Belting Machine and Sealing Machine; Conveyor Muck Cars (Haglund or Similar Type); Drills, all; Finishing Machine - Concrete; Highlift Shovels or Front Endloader; Hoist - Sewer Dragging Machine; Hydraulic Boom Trucks (All Attachments); Hydro Blaster; All Locomotives, Dinky; Off-Road Hauling Units (including articulating) / 2 ton capacity or more; Non-Self Loading Ejection Dump; Pump Cretes: Squeeze Cretes - Screw Type Pumps, Gypsum Bulker and Pump; Roller, Asphalt; Rotary Snow Plows; Rototiller, Seaman, etc., self-propelled; Scoops - Tractor Drawn; Self-Propelled Compactor; Spreader - Chip - Stone, etc.; Scraper; Scraper - Prime Mover in Tandem (Regardless of Size); Tank Car Heater; Tractors, Push, Pulling Sheeps Foot, Disc, Compactor, etc.; Tug Boats.

Class 3. Boilers; Brooms, All Power Propelled; Cement Supply Tender; Compressor, Common Receiver (2); Concrete Mixer (Two Bag and Over); Conveyor, Portable; Farm-Type Tractors Used for Mowing, Seeding, etc.; Fireman on Boilers; Forklift Trucks; Grouting Machine; Hoists, Automatic; Hoists, All Elevators; Hoists, Tugger Single Drum; Jeep Diggers; Low Boys; Pipe Jacking Machines; Post-Hole Digger; Power Saw, Concrete Power Driven; Pug Mills; Rollers, other than asphalt; Seed and Straw Blower; Steam Generators; Stump Machine; Winch Trucks with "A" Frame; Work Boats; Tamper - Form - Motor Driven.

Class 4. Air Compressor - Small and Large; Asphalt Spreader, Backend Man; Bobcat (Skid Steer) all; Brick Forklift; Combination - Small Equipment Operator; Directional Boring Machine up to 12"; Generators; Heaters, Mechanical; Hydraulic Power Unit (Pile Driving, Extracting, or Drilling); Hydro-Blaster; Light Plants, All (1 through 5); Pumps, over 3" (1 to 3 not to exceed a total of 300 ft.); Pumps, Well Points; Tractaire; Trencher 12" and under; Welding Machines (2 through 5); Winches, 4 Small Electric Drill Winches.

Class 5. Oilers and Directional Boring Machine Locator.

Class 6. Field Mechanics and Field Welders

Class 7. Gradall and machines of like nature.

TRUCK DRIVER - BUILDING, HEAVY AND HIGHWAY CONSTRUCTION

Class 1. Two or three Axle Trucks. A-frame Truck when used for transportation purposes; Air Compressors and Welding Machines, including those pulled by cars, pick-up trucks and tractors; Ambulances; Batch Gate Lockers; Batch Hopperman; Car and Truck

Washers; Carry-alls; Fork Lifts and Hoisters; Helpers; Mechanics Helpers and Greasers; Oil Distributors 2-man operation; Pavement Breakers; Pole Trailer, up to 40 feet; Power Mower Tractors; Self-propelled Chip Spreader; Skipman; Slurry Trucks, 2-man operation; Slurry Truck Conveyor Operation, 2 or 3 man; TTeamsters Unskilled dumpman; and Truck Drivers hauling warning lights, barricades, and portable toilets on the job site.

Class 2. Four axle trucks; Dump Crets and Adgetors under 7 yards; Dumpsters, Track Trucks, Euclids, Hug Bottom Dump Turnapulls or Turnatrailers when pulling other than self-loading equipment or similar equipment under 16 cubic yards; Mixer Trucks under 7 yards; Ready-mix Plant Hopper Operator, and Winch Trucks, 2 Axles.

Class 3. Five axle trucks; Dump Crets and Adgetors 7 yards and over; Dumpsters, Track Trucks, Euclids, Hug Bottom Dump Turnatrailers or turnapulls when pulling other than self-loading equipment or similar equipment over 16 cubic yards; Explosives and/or Fission Material Trucks; Mixer Trucks 7 yards or over; Mobile Cranes while in transit; Oil Distributors, 1-man operation; Pole Trailer, over 40 feet; Pole and Expandable Trailers hauling material over 50 feet long; Slurry trucks, 1-man operation; Winch trucks, 3 axles or more; Mechanic--Truck Welder and Truck Painter.

Class 4. Six axle trucks; Dual-purpose vehicles, such as mounted crane trucks with hoist and accessories; Foreman; Master Mechanic; Self-loading equipment like P.B. and trucks with scoops on the front.

Other Classifications of Work:

For definitions of classifications not otherwise set out, the Department generally has on file such definitions which are available. If a task to be performed is not subject to one of the classifications of pay set out, the Department will upon being contacted state which neighboring county has such a classification and provide such rate, such rate being deemed to exist by reference in this document. If no neighboring county rate applies to the task, the Department shall undertake a special determination, such special determination being then deemed to have existed under this determination. If a project requires these, or any classification not listed, please contact IDOL at 217-782-1710 for wage rates or clarifications.

LANDSCAPING

Landscaping work falls under the existing classifications for laborer, operating engineer and truck driver. The work performed by landscape plantsman and landscape laborer is covered by the existing classification of laborer. The work performed by landscape operators (regardless of equipment used or its size) is covered by the classifications of operating engineer. The work performed by landscape truck drivers (regardless of size of truck driven) is covered by the classifications of truck driver.