

TYPICAL APPLICATION FOR SOLID YELLOW, SKIP-DASH LANE LINES WITH RAISED REFLECTIVE PAVEMENT MARKERS  
**SOLID YELLOW, SKIP DASH PAVEMENT MARKING DETAIL**  
 (NOT TO SCALE)

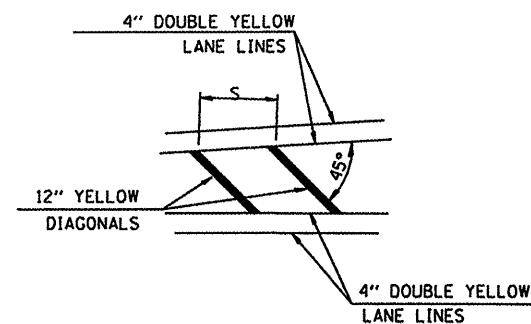

TYPICAL APPLICATION FOR MEDIAN STRIPING  
 (NOT TO SCALE)

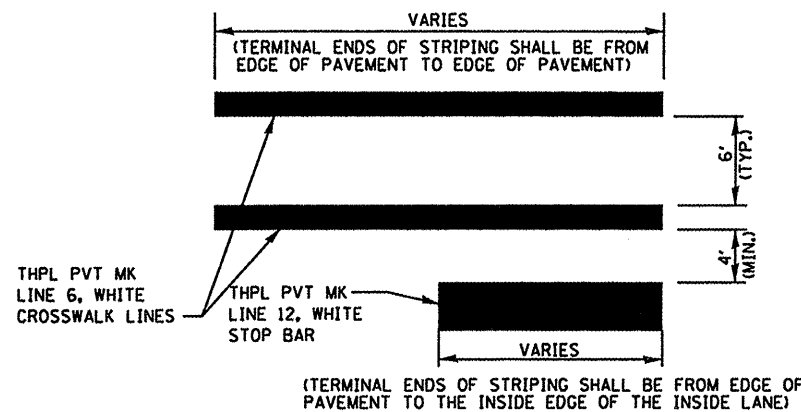

TYPICAL CROSSWALK DETAIL  
 (NOT TO SCALE)

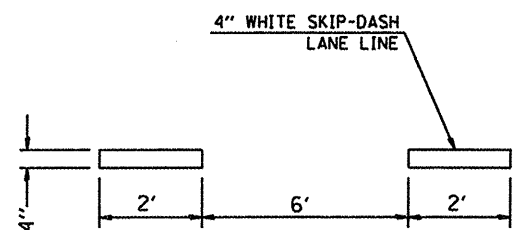

TYPICAL APPLICATION FOR WHITE SKIP-DASH LANE LINES  
 (NOT TO SCALE)

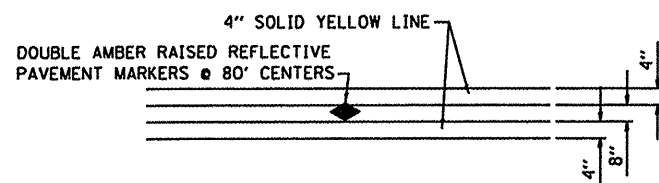

TYPICAL APPLICATION FOR DOUBLE YELLOW LANE LINES WITH RAISED REFLECTIVE PAVEMENT MARKERS  
**DOUBLE SOLID YELLOW PAVEMENT MARKING DETAIL**  
 (NOT TO SCALE)

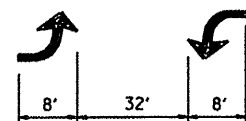

TWO-WAY LEFT TURN ARROW PAVEMENT MARKING DETAIL  
 (NOT TO SCALE)

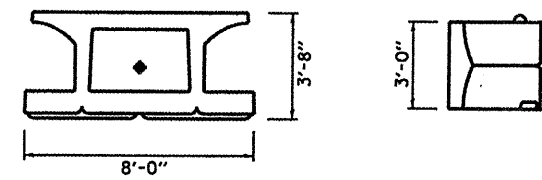

LARGE BLOCK DETAIL  
 (NOT TO SCALE)

STANDARD SQUARE FOOTAGE OF BLOCK = 24 SF  
 STANDARD BLOCK WEIGHT = 1,500 LBS  
 ACTUAL DIMENSIONS & MEASUREMENTS MAY VARY DEPENDING ON BLOCK MANUFACTURER

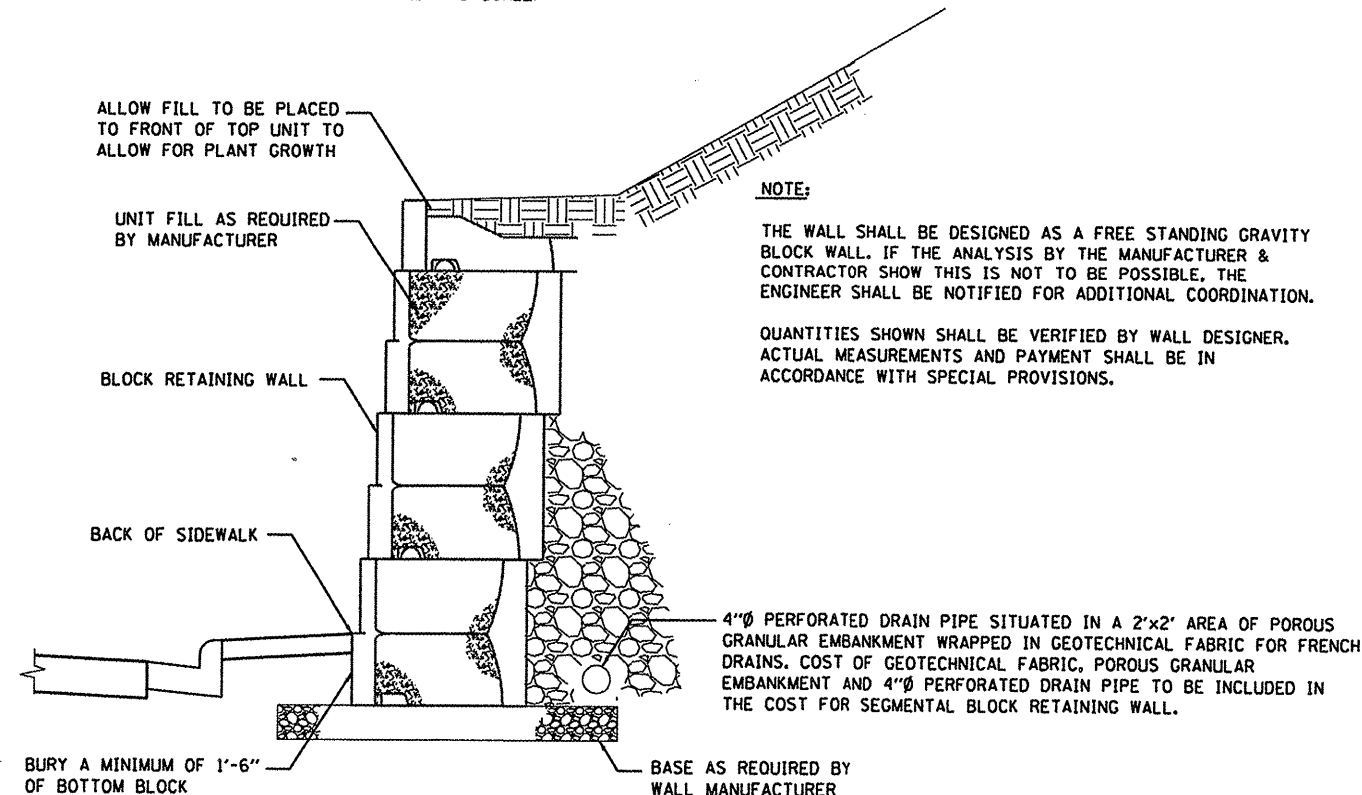

SEGMENTAL BLOCK RETAINING WALL CONSTRUCTION DETAIL  
 (NOT TO SCALE)

FILE NAME =	USER NAME = default	DESIGNED -	REVISED -
H:\NP\219661\Microstation\CADD Sheets\08219661-sht-details.dgn		DRAWN -	REVISED -
		CHECKED -	REVISED -
		DATE -	REVISED -

STATE OF ILLINOIS  
 DEPARTMENT OF TRANSPORTATION

DETAILS				
SCALE:	SHEET NO.	OF	SHEETS	STA. TO STA.

F.A.U. RTE.	SECTION	COUNTY	TOTAL SHEETS	SHEET NO.
9330	08-00211-00-PV	ST. CLAIR	85	32
CONTRACT NO. 97480			ILLINOIS FED. AID PROJECT	