

FAU RTE	SECTION	COUNTY	TOTAL SHEETS	SHEET NO.
1447	03-00159-00-RS	COOK	24	19
F. HW. A. REG.		ILLINOIS PROJECT STPM-8003(581)		CONTRACT NO. 83835

R-3281-AL
Curb Inlet Frame, Grate and Curb Box

Heavy Duty
Also available with open curb box (no bars), or with flat curb plate instead of curb box. (See R-3246-1)

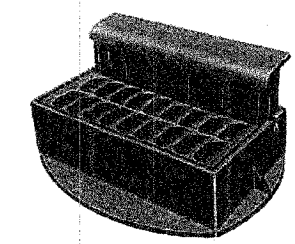
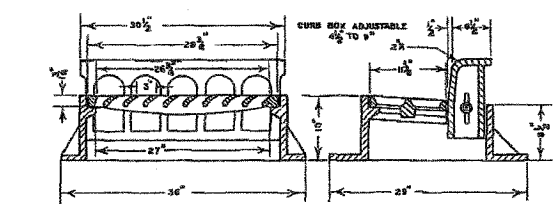

CURB INLET FRAME, GRATE AND CURB BOX

PRECAST PCC STRUCTURE TO BE DELIVERED IN TWO PIECES. THE WALL SECTION SHALL HAVE TWO CASTED HOLES AT THE BOTTOM TO ACCOMMODATE THE EXISTING WATER SERVICE PIPE.

STRUCTURE AND FRAME PLACEMENT SHALL BE OUT OF THE CURBLINE AND ROADWAY WHEN POSSIBLE

CA-6 BACKFILL COMPACTED IN PLACE

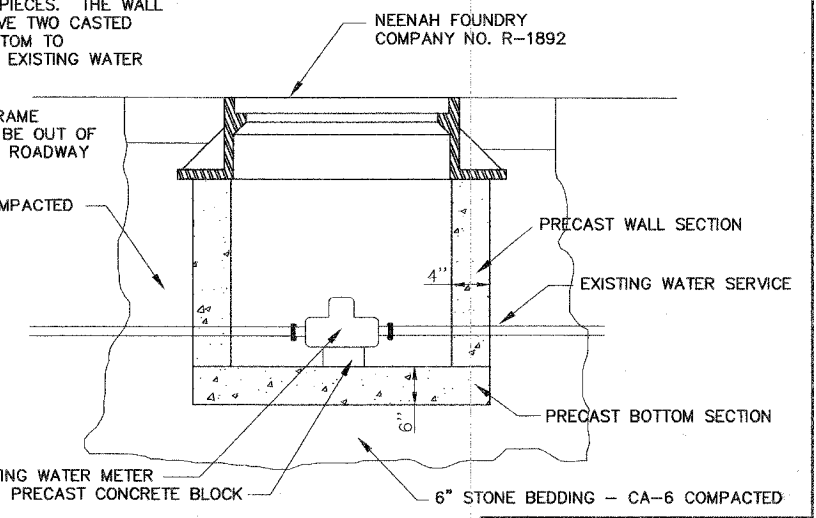

NEENAH FOUNDRY COMPANY NO. R-1892

DOMESTIC WATER METER VAULT ADJUSTMENT, SPECIAL

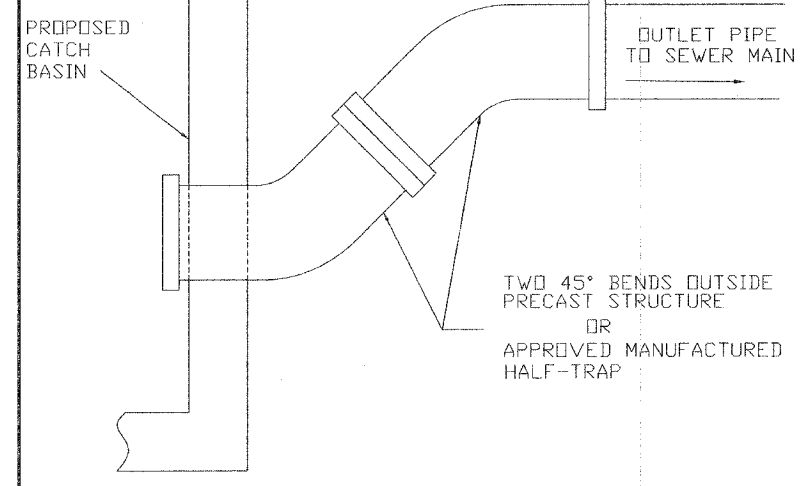

TWO 45° BENDS OUTSIDE PRECAST STRUCTURE OR APPROVED MANUFACTURED HALF-TRAP

HALF-TRAP DETAIL

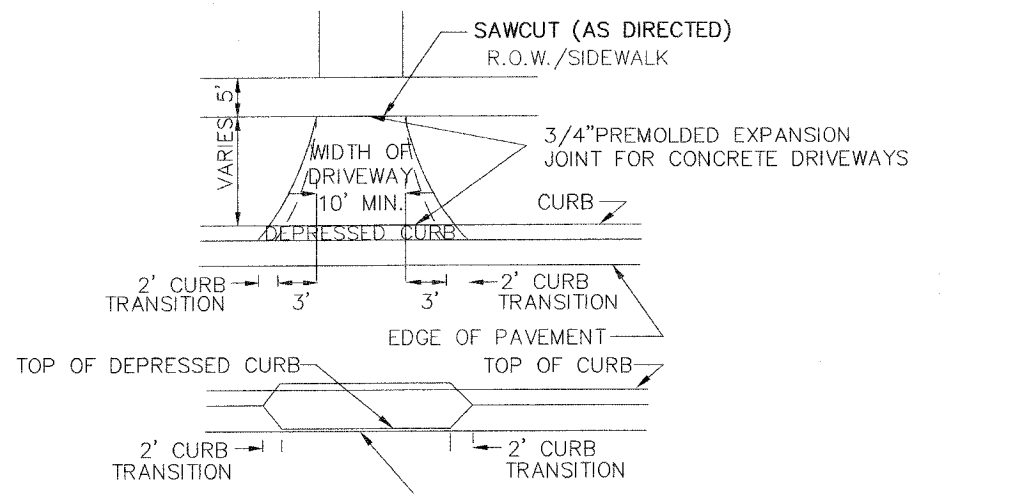

THICKNESS OF CURB AND GUTTER FLAG SHALL BE 9 INCHES, MIN.
SAWCUTTING AND THE 3/4" PREMOLDED EXPANSION JOINT WILL NOT BE PAID SEPARATELY BUT SHALL BE CONSIDERED INCIDENTAL TO PCC DRIVEWAY PAVEMENT, 7"

TYPICAL DRIVEWAY DETAIL

JOINT DETAILS

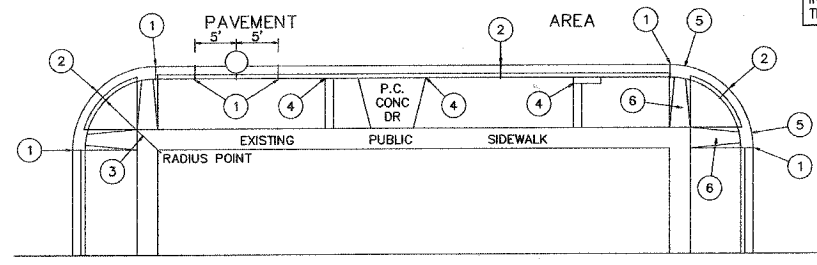

ALL MATERIALS AND LABOR NEEDED TO FULFILL THE REQUIREMENTS OF THESE JOINT DETAILS SHALL BE CONSIDERED INCIDENTAL TO THE PAY ITEMS THEY PERTAIN TO

1. EXPANSION JOINTS AT TANGENT POINTS AND 150 FOOT INTERVALS, CONSISTING OF ONE INCH PREMOLDED JOINT FILLER MATERIAL WITH #8 DOWEL BARS, 18" IN LENGTH, GREASED, PROVIDE EXPANSION CAP ON ONE END. ALSO CONSTRUCT THIS JOINT FIVE FEET EACH SIDE OF PROPOSED UNDERGROUND STRUCTURE.
2. CONTRACTION JOINTS AT TWENTY-FIVE FOOT INTERVALS AND AT THE CENTER OF RETURNS.
3. ALL RADI SHALL MATCH EXISTING UNLESS OTHERWISE DIRECTED BY THE ENGINEER.
4. LONGITUDINAL EXPANSION JOINT CONSISTING OF ONE INCH PREMOLDED JOINT FILLER.
5. DEPRESS CURB AT LOCATIONS WHERE PUBLIC WALKS INTERSECT CURB LINE AT STREET INTERSECTIONS, ALLEYS, AND OTHER LOCATIONS AS DIRECTED.
6. INSTALL HANDICAP RAMP AT LOCATIONS WHERE PUBLIC WALKS INTERSECT CURB LINE AT STREET INTERSECTIONS AND ALLEYS AS DIRECTED.

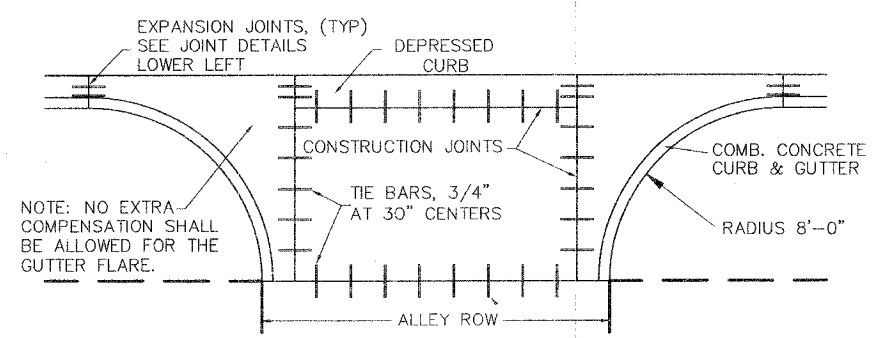

NOTE: NO EXTRA COMPENSATION SHALL BE ALLOWED FOR THE GUTTER FLARE.

PLAN VIEW

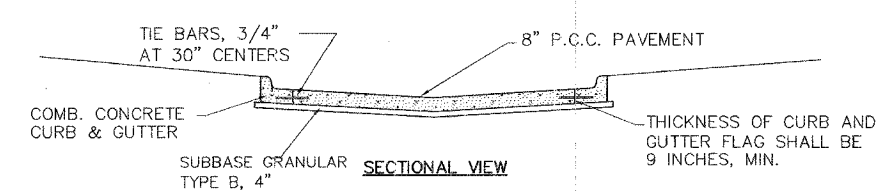

SECTIONAL VIEW

TYPICAL ALLEY RETURN DETAIL

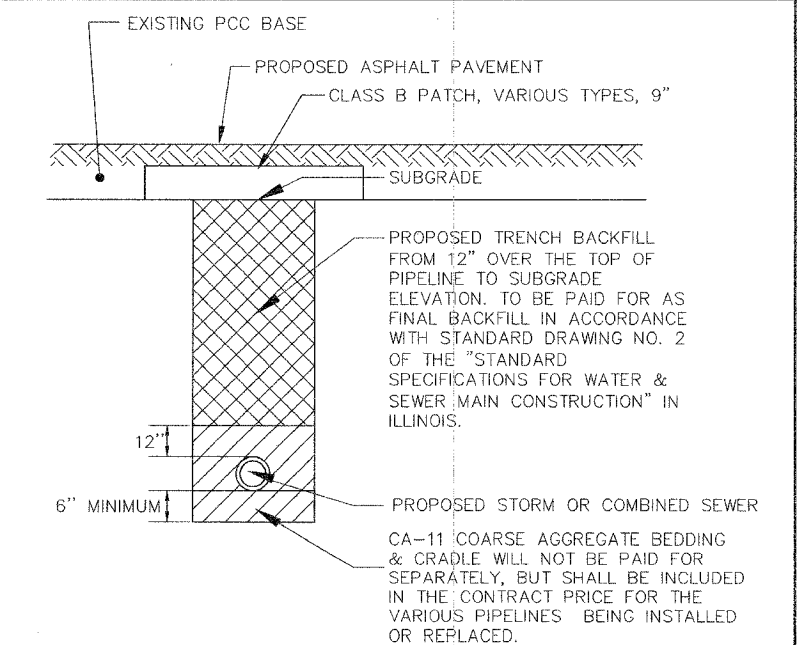

CA-11 COARSE AGGREGATE BEDDING & CRADLE WILL NOT BE PAID FOR SEPARATELY, BUT SHALL BE INCLUDED IN THE CONTRACT PRICE FOR THE VARIOUS PIPELINES BEING INSTALLED OR REPLACED.

TYPICAL TRENCH DETAIL

Frank Novotny & Associates, Inc.
Civil Engineers/Municipal Consultants
825 Midway Drive • Willowbrook, IL • 60527 • Telephone: (630) 887-8640 • Fax: (630) 887-0132
Illinois Professional Design Firm No. 184-000928

PROJECT CITY OF BERWYN, ILLINOIS
16TH STREET RESURFACING
SECTION NO. 03-000159-00-RS

REVISIONS			
NO.	BY	DATE	DESCRIPTION
1	THK	11/30/05	PER IDOT DIST. 1 B.L.R. COMMENTS
2	THK	12/12/05	PER IDOT DIST. 1 B.L.R. COMMENTS
3	THK	12/16/05	PER IDOT DIST. 1 B.L.R. COMMENTS

CONSTRUCTION STANDARDS

PROJECT NO. 02260	SCALE NONE	SHEET 19
DRAWN/DESIGNED JEP-RAW/THK	DATE OCT., 2005	OF 24
CHECKED/APPROVED JEF	FIELD BOOK NO. FILE	SHEETS

M:\Berwyn\2002\02260 - 18th St - L.R.P.P.02260_03T19_CONSTRUCTION DETAILS.dwg, 12/20/2005 2:04:46 PM