

SECTION	COUNTY	TOTAL SHEETS	SHEET NO.
80-5999-1K, BY&AC-BI	WILL	497	337
STA.	TO STA.	ILLINOIS	
		FED. AID PROJECT	

#80906

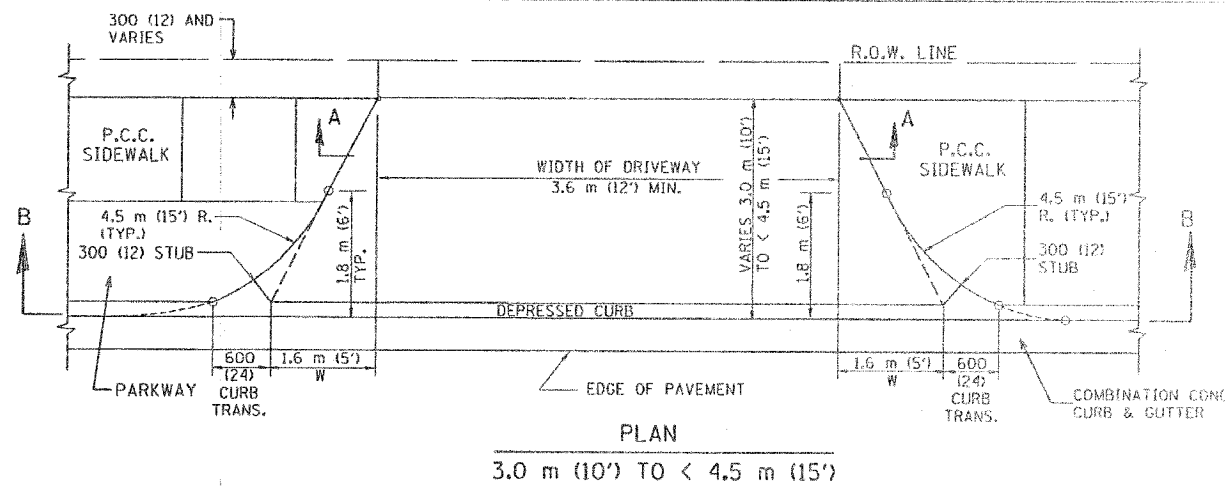

PLAN
3.0 m (10') TO < 4.5 m (15')

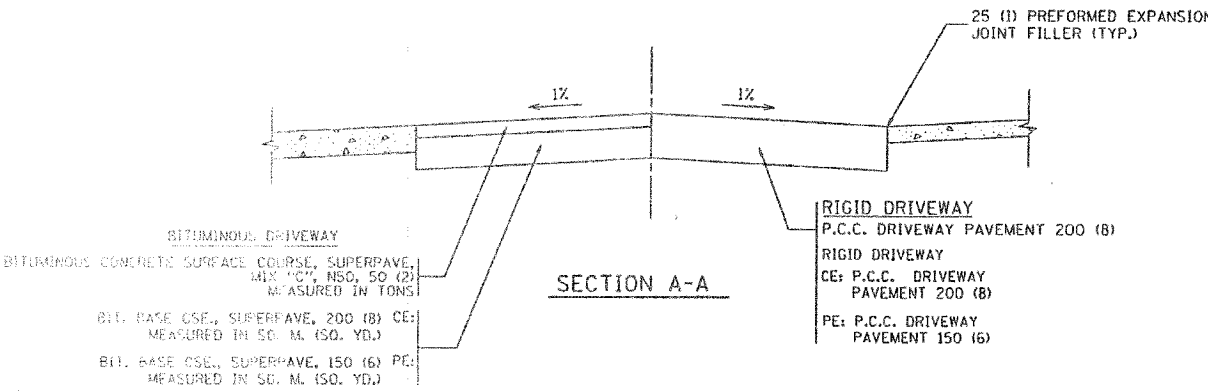

SECTION A-A

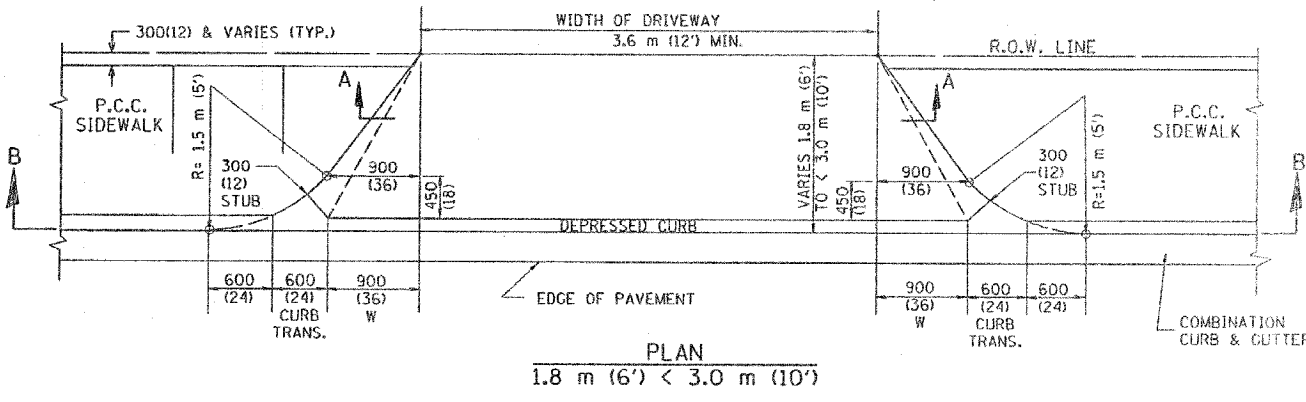

PLAN
1.8 m (6') < 3.0 m (10')

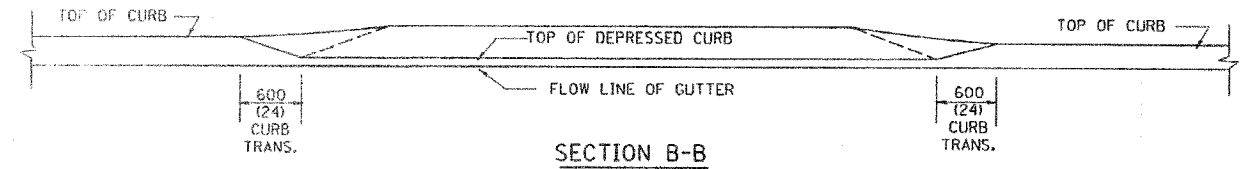

SECTION B-B

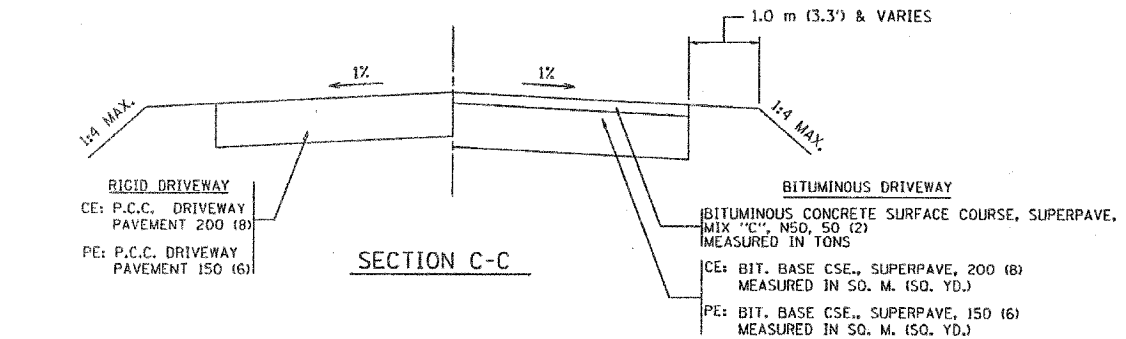

SECTION C-C

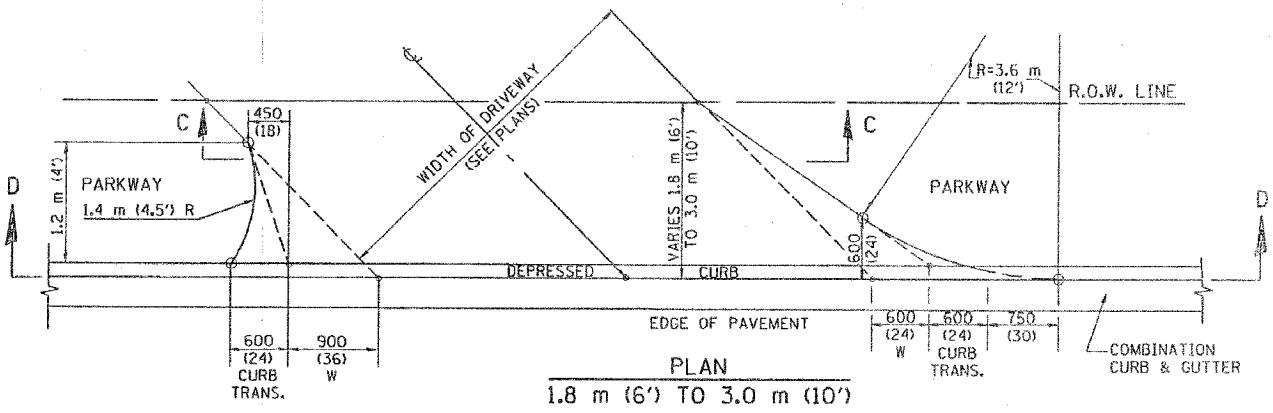

PLAN
1.8 m (6') TO 3.0 m (10')

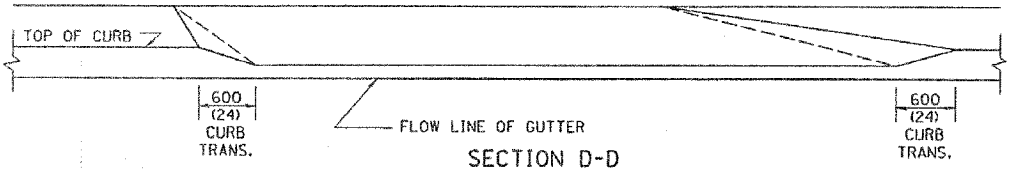

SECTION D-D

GENERAL NOTES

DRIVEWAY SLOPES, LOCATIONS, & GEOMETRIC LAYOUT SHALL BE IN ACCORDANCE WITH THE LATEST EDITION OF THE "HANDBOOK FOR POLICY ON PERMITS FOR ACCESS DRIVEWAYS TO STATE HIGHWAYS". FOR FURTHER LAYOUT REQUIREMENTS, REFER TO ILLUSTRATIONS IN THE PERMIT HANDBOOK. WHERE SIDEWALKS EXIST, DRIVEWAYS SHALL BE REPLACED WITH RIGID PAVEMENT. WHERE NO SIDEWALKS EXIST, DRIVEWAYS SHALL BE REPLACED IN KIND. SIDEWALK CROSS SLOPE THRU DRIVEWAY AREA TO BE A MAXIMUM OF 1:50.

WHEN THE DISTANCE BETWEEN R.O.W. AND THE BACK OF CURB IS EQUAL TO OR LESS THAN 2.4 M (8'), THE P.C.C. SIDEWALK SHALL EXTEND TO THE BACK OF CURB.

THE RESIDENT ENGINEER SHALL CONTACT THE TRAFFIC PERMIT OFFICE AT 847/705-4131 FOR ANY QUESTIONS ON DRIVEWAYS SHOWN IN THE PLANS; SPECIFICALLY IN REFERENCE TO ADDITIONAL AND/OR RELOCATION/REMOVAL OF A DRIVEWAY.

COMBINATION CONCRETE CURB & GUTTER SHALL BE MEASURED STRAIGHT ACROSS THE DRIVEWAY. NO ADDITIONAL COMPENSATION WILL BE ALLOWED FOR THE CURB & GUTTER TRANSITION.

25 (1) PREFORMED EXPANSION JOINT FILLER WILL NOT BE PAID SEPARATELY, BUT SHALL BE CONSIDERED INCLUDED IN THE COST OF THE P.C.C. DRIVEWAY PAVEMENT OR P.C.C. SIDEWALK.

"W" VARIES FROM 900 (36) TO 1.5 m (5 FT.) PROPORTIONAL TO THE LENGTH (L), FROM 1.8 m (6 FT.) TO 3 m (10 FT.).

ALL DIMENSIONS ARE IN MILLIMETERS (INCHES) UNLESS OTHERWISE NOTED.

ILLINOIS DEPARTMENT OF TRANSPORTATION

DRIVEWAY DETAILS

DISTANCE BETWEEN ROW AND FACE OF CURB < 4.5 m (15')

REVISIONS	
NAME	DATE
P. LOFLEUR	04/15/03
M. GOMEZ	04/06/01
R. SHAH	11/06/95
J. POLLASTRINI	08/12/96
J. POLLASTRINI	12/14/96
A. ABBAS	03/21/97
T. HOLTZ	04/08/97

SCALE: NONE
DATE PLOTTED 04/17/2003

DRAWN BY: SC
CHECKED BY: JFP
BD400-02 (BD-02)