

---

**STRUCTURE GEOTECHNICAL REPORT  
US ROUTE 14 RETAINING WALL 2  
PROPOSED SN 016-9201  
COOK COUNTY, ILLINOIS**

**For  
Accurate Group, Inc.  
101 Shelter Road, Suite B200  
Lincolnshire, IL 60069**

**Submitted by  
Wang Engineering, Inc.  
1145 North Main Street  
Lombard, IL 60148**

**Original Report: March 30, 2021  
Revised Report: NA**

**Technical Report Documentation Page**

<b>1. Title and Subtitle</b> Structure Geotechnical Report US Route 14 Retaining Wall 2		<b>2. Original Date:</b> March 30, 2021 <b>Revised Date:</b> NA
		<b>3. Report Type</b> <input checked="" type="checkbox"/> SGR <input type="checkbox"/> RGR <input checked="" type="checkbox"/> Draft <input type="checkbox"/> Final <input type="checkbox"/> Revised
<b>4. Route / Section / County</b> FAU 3512/ 2018-109-RS,SW&T/ Cook		<b>5. Contract</b> 62H38
<b>6. PTB / Item No.</b> 184/ 010 (Task 39)	<b>7. Existing Structure Number(s)</b> NA	<b>8. Proposed Structure Number(s)</b> 016-9201
<b>9. Prepared by</b> Wang Engineering, Inc. 1145 N Main Street Lombard, IL 60148	<b>Contributor(s)</b> Author: Nesam S. Balakumaran, PEng QA/QC: Corina T. Farez, PE, PG PM: Andri Kurnia, PE	<b>Contact Information</b> (630) 953-9928 ext. 1025 <a href="mailto:akurnia@wangeng.com">akurnia@wangeng.com</a>
<b>10. Prepared for</b> Accurate Group, Inc. 101 Schelter Road, Suite B200 Lincolnshire, IL, 60069	<b>Contact(s)</b> Jennifer Tobergte, PE (Accurate Group, Inc.) Robert T. Boro, PE (HBM Engineering Group, LLC)	<b>Contact Information</b> (847) 613-1100 ext. 507 <a href="mailto:jent@accgi.com">jent@accgi.com</a> (708) 236-0900 ext. 115 <a href="mailto:robert.boro@hbmengineering.com">robert.boro@hbmengineering.com</a>
<b>11. Abstract</b> A new retaining wall is proposed along westbound US Route 14 to support a new 10.0-foot wide bike path. The wall will be about 495.0 feet long, extending from Station 119+82 to Station 124+49. The face of the wall will be constructed about 44 feet north of the US 14 centerline. The wall will have a maximum exposed height of 8.0 feet. This report provides geotechnical recommendations for the design and construction of the proposed retaining wall.  Along the proposed wall alignment, the foundation soils consists of up to 6 feet of medium stiff to very stiff clay to silty clay fill overlying natural stiff to hard clay and silty clay to silty clay loam interbedded with wet to saturated sand and silt layers. We estimate the groundwater table may be at elevation of 625 feet.  The proposed retaining wall will be in a cut section. A drilled soldier-pile wall type is proposed at the site. Geotechnical parameters for the design and construction of soldier pile and lagging wall are provided. The minimum cantilevered pile embedment depths necessary to achieve the required factor of safety for global stability is 624.4 feet elevation; however, the lateral earth pressure and deformation analyses typically will determine the minimum embedment depth for cantilevered pile wall. Therefore, the designer should perform other analyses including lateral earth pressure and deflection analyses to determine the required design pile embedment.  Groundwater was encountered at elevations ranging from 612 to 626 feet within the interbedded silt/sand layers. For drilled soldier piles installations, temporary casing and/or wet installation methods will be required. In addition, hard drilling should be anticipated during drilled soldier pile installation at or below 612 feet.		
<b>12. Path to archived file</b>  S:\Netprojects\4910404\Reports\EastWall_SN0169201\RPT_Wang_NSB_4910404US14RWSN0169201_SGR_V01_20210329.doc		

## TABLE OF CONTENTS

<b>1.0</b>	<b>INTRODUCTION.....</b>	<b>1</b>
1.1	PROPOSED STRUCTURE.....	1
<b>2.0</b>	<b>METHODS OF INVESTIGATION.....</b>	<b>1</b>
2.1	FIELD INVESTIGATION.....	2
2.2	LABORATORY TESTING.....	2
<b>3.0</b>	<b>INVESTIGATION RESULTS.....</b>	<b>3</b>
3.1	LITHOLOGICAL PROFILE.....	3
3.2	GROUNDWATER CONDITIONS.....	4
<b>4.0</b>	<b>FOUNDATION ANALYSIS AND RECOMMENDATIONS.....</b>	<b>4</b>
4.1	SEISMIC DESIGN CONSIDERATIONS .....	4
4.2	DRILLED SOLDIER PILE AND LAGGING WALL.....	5
4.3	GLOBAL STABILITY .....	9
<b>5.0</b>	<b>CONSTRUCTION CONSIDERATIONS .....</b>	<b>10</b>
5.1	SITE PREPARATION .....	10
5.2	EXCAVATION, DEWATERING AND UTILITIES.....	10
5.3	FILLING AND BACKFILLING.....	10
5.4	EARTHWORK OPERATIONS .....	11
<b>6.0</b>	<b>QUALIFICATIONS.....</b>	<b>12</b>
	REFERENCES .....	13
	EXHIBITS	
	1. <i>SITE LOCATION MAP</i>	
	2. <i>BORING LOCATION PLAN</i>	
	3. <i>SOIL PROFILE</i>	
	APPENDIX A	
	<i>BORING LOGS</i>	
	APPENDIX B	
	<i>LABORATORY TEST RESULTS</i>	
	APPENDIX C	
	<i>GLOBAL STABILITY ANALYSIS</i>	

APPENDIX D

*GENERAL PLAN AND ELEVATION*

**LIST OF TABLES**

Table 1: Undrained (Short-term) Geotechnical Parameters for Design of S-P Wall, Sta. 119+82 to 121+36 .....	5
Table 2: Undrained (Short-term) Geotechnical Parameters for Design of S-P Wall, Sta. 121+36 to 124+49 .....	6
Table 3: Drained (Long-term) Geotechnical Parameters for Design of S-P Wall, Sta. 119+82 to 121+36.....	7
Table 4: Drained (Long-term) Geotechnical Parameters for Design of S-P Wall, Sta. 121+36 to 124+49.....	7
Table 5: Recommended Geotechnical Parameters for Lateral Load Analysis, Sta. 119+82 to 121+36.....	8
Table 6: Recommended Geotechnical Parameters for Lateral Load Analysis, Sta. 121+36 to 124+49 .....	9
Table 10: Results of Global Stability Analysis .....	10

---

**STRUCTURE GEOTECHNICAL REPORT  
US ROUTE 14 RETAINING WALL 2  
PROPOSED SN 016-9201  
COOK COUNTY, ILLINOIS  
FOR  
ACCURATE GROUP, INC.**

## **1.0 INTRODUCTION**

This report presents the results of our subsurface investigation, laboratory testing, and geotechnical engineering evaluations in support of the design and construction of a new retaining wall, designated as SN 016-9201, proposed along westbound US Route 14 (US 14) and immediately east of Wisconsin Central Ltd. Railroad at US 14 in Cook County, Illinois. A *Site Location Map* is presented as Exhibit 1.

### **1.1 Proposed Structure**

Based on the in-progress *General Plan and Elevation (GPE)* drawings provided by HBM Engineering Group, LLC on March 26, 2021, Wang Engineering, Inc. (Wang) understands the proposed retaining wall will measure about 495.0 feet in length, extending along US 14 from Station 119+82.11 to Station 124+48.51. The face of the wall will be constructed at average distance of about 44 feet north of the existing US 14 centerline. The wall will support a new 10.0-foot wide bike path to be constructed along US 14 westbound. Based on the drawings, we estimate the wall will have a maximum exposed height of approximately 8.0 feet at Station 121+44. A drilled soldier-pile wall type is preferred wall type and shown on the GPE sheets (Appendix D).

The purpose of this investigation was to characterize the site soil and groundwater conditions, perform geotechnical analyses, and provide recommendations for the design and construction of the proposed retaining wall.

## **2.0 METHODS OF INVESTIGATION**

The following sections outline the subsurface and laboratory investigations performed by Wang.

## 2.1 Field Investigation

The current subsurface investigation along the wall alignment consisted of five structure borings, designated as RW-06 through RW-10, three geoprobe borings, designated as HA-RW-01 through HA-RW-03 drilled by Wang from March 8 to 10, 2021. The RW-series borings were drilled from elevations of 628.9 to 639.6 feet to depths of 20 to 30 feet and HA-series borings were drilled from 636.7 to 640.9 feet to depths of 6 feet below the ground surface (bgs). To supplement our investigation, we considered several nearby borings performed by Wang in 2015. The supplemental borings NDB-09 through NDB-14, HA-NDB-10, and HA-NDB-11 were advanced from elevations 628.0 to 40.3 feet to depths of 6 to 35 bgs.

The as-drilled northings and eastings were acquired with a mapping-grade GPS unit. Elevations, stations, and offsets were provided by Accurate. The boring location information is included in the *Boring Logs* (Appendix A) and the as-drilled locations are shown in the *Boring Location Plan* (Exhibit 3).

An ATV-mounted drilling rig equipped with hollow stem augers was used to advance and maintain open boreholes. Soil sampling was performed according to AASHTO T 206, “*Penetration Test and Split Barrel Sampling of Soils*.” The soil was sampled at 2.5-foot intervals to 30 feet bgs and 5-foot interval thereafter. A jackhammer driven geoprobe sampler was used in HA-series borings to continuously sample the soils. Soil samples collected from each sampling interval were placed in sealed jars and transported to the laboratory for further examination and laboratory testing.

Field boring logs, prepared and maintained by a Wang field engineer, included lithological descriptions, visual-manual soil classifications, pocket penetrometer and Rimac unconfined compressive strength tests, and results of field standard penetration test (SPT) results recorded as blows per 6 inches of penetration.

Groundwater levels were measured while drilling and at completion of each boring. At each structure boring location, the boreholes were backfilled upon completion with lean grout, and the surface was restored as close as possible to its original condition.

## 2.2 Laboratory Testing

Soil samples were tested in our laboratory for moisture content (AASHTO T 265). Atterberg limits (AASHTO T 89/90) and particle size (AASHTO T 88) analyses are being performed on selected

samples. Field visual descriptions of soil samples were verified in the laboratory and index tested soils were classified according to the IDH Soil Classification System. The laboratory test results are shown in the *Boring Logs* (Appendix A) and *Laboratory Test Results* (Appendix B).

### **3.0 INVESTIGATION RESULTS**

Detailed descriptions of the soil conditions encountered during the subsurface investigation are presented in the attached *Boring Logs* (Appendix A) and in the *Soil Profile* (Exhibit 4). Please note that strata contact lines represent approximate boundaries between soil types. The actual transition between soil types in the field may be gradual in horizontal and vertical directions.

#### **3.1 Lithological Profile**

Borings RW-06 through RW-10, drilled along the existing westbound, encountered either 4 to 13 inches of asphalt or 4.0 to 9.5 inches asphalt over 5.5 to 10.0 inches concrete. The HA-series drilled from the existing top of US 14 embankment back slope, encountered 4 to 10 inches of black and dark brown, silty clay to silty loam topsoil at the surface. The previous NDB-series encountered either 3 to 7 inches of asphalt or 8.0 to 9.0 inches asphalt over 4.0 to 10.0 inches concrete. In descending order, the general lithologic succession encountered beneath the topsoil or pavement includes: 1) man-made ground (fill) and 2) stiff to hard clay and silty clay to silty clay loam.

##### *(1) Man-made ground (fill)*

Underneath the pavement, the borings encountered 2 to 6 feet of fill materials. The fill consists of medium stiff to very stiff brown to gray clay to silty clay. The cohesive fill has unconfined compressive strength ( $Q_u$ ) values of 0.5 to 3.8 tsf and moisture content values of 17 to 28%. Laboratory index testing within this layer shows a liquid limit ( $L_L$ ) value of 34% and a plastic limit ( $P_L$ ) value of 16%.

##### *(2) Stiff to hard clay and silty clay to silty clay loam*

Beneath the fill, pavement or topsoil, the borings advanced through stiff to hard, brown to gray clay and silty clay to silty clay loam with  $Q_u$  values of 1.0 to greater than 4.5 tsf and moisture content values of 10 to 25% interbedded with wet to saturated silt, sand, and silty loam. Laboratory index testing within this layer shows  $L_L$  values of 28 to 40% and a  $P_L$  value of 17%.

Interbedded wet to saturated silt, sand, and silty loam layers of thickness ranging from 4 to 20 feet are characterized by N values of 5 to 67 blows per foot and moisture contents of 14 to 26%. Hard drilling conditions should be expected at or below elevation of 612 feet in dense to very dense silt to sand layers and hard silty clay to silty clay loam for drilled pile installation.

### **3.2 Groundwater Conditions**

Groundwater was encountered within interbedded silt and sand layers while drilling at elevations of 619 to 626 (3 to 17 feet bgs). At the completion of drilling, the groundwater was observed at elevations of 612 to 621 feet (10 to 24 feet bgs). The interbedded silt and sand layers were mostly saturated. We estimate the permanent groundwater lies at 625 feet elevation. It should be noted that groundwater levels might change with seasonal rainfall patterns and long-term climate fluctuations or may be influenced by local site conditions.

## **4.0 FOUNDATION ANALYSIS AND RECOMMENDATIONS**

The retaining wall will support a new 10.0-foot wide proposed bike path proposed along westbound US Route 14. Based on the GPE (Appendix D), the wall will have a total length of 495.0 feet and a maximum exposed height of 8.0 feet near Station 121+44. As part of the improvements proposed along US 14, we understand the new storm sewer will be installed at a minimum of 20 feet from the front face of the proposed retaining wall alignment.

The proposed wall will be a cut wall with a back slope of 1:2 (V:H). Generally, non-gravity wall types such as a sheet pile or soldier pile type wall would be more suitable. Mechanically Stabilized Earth (MSE) and Reinforced Concrete Cantilever (RCC) would require large open cut excavations into the existing slope, temporary soil retention systems, and will impact the existing US 14 right of way. The construction of these wall types would likely also require more backfilling thus longer construction time. Installation of sheet pile or driven soldier pile wall will be difficult due to the encountered soil conditions and existing powerline and will likely require anchors. We concur the proposed drilled soldier pile wall would be more appropriate for this site. Recommendations for the design and construction of drilled soldier pile wall are discussed in the following sections.

### **4.1 Seismic Design Considerations**

Seismic design is not required for retaining wall structures located in Seismic Performance Zone (SPZ) 1 in accordance with the IDOT *Bridge Manual* (2012).



## 4.2 Drilled Soldier Pile and Lagging Wall

Drilled soldier pile system should be designed for both lateral earth pressure and lateral deformation. The embedment depth in moment equilibrium for the wall sections should be designed in accordance with the AASHTO LRFD guidelines (AASHTO 2020).

Generally, both granular soils and overconsolidated clayey soils, such as the stiff to hard silty clay to silty clay loam encountered in the borings will exhibit lower overall shear strength in the long-term condition. However, we recommend the lateral earth pressure analysis should be performed for the wall in both short-term (undrained) and long-term (drained) conditions using the soil parameters recommended in Tables 1 through 4 based on station limits. Elevations provided in tables are based on the average layer elevations across the soil profile and may vary from one boring location to another. The active and passive earth pressure coefficients are provided for a slope of 1:2 (V:H) backfill behind the wall and a straight slope in front of the wall.

The design of the wall should ignore 3.0 feet of soil in front of the wall measured from the finished ground surface elevation in providing passive pressure due to excavations required for installation of concrete facing, drainage systems, and frost-heave conditions. In developing the design lateral pressure, the pressure due to any existing structures and construction equipment surcharge loads should be added to the lateral earth pressure. Drainage behind the wall should be in accordance with IDOT guidelines (IDOT 2012). The water pressure should be added to the earth pressure if drainage is not provided. The wall design should consider the permanent groundwater at elevation of 625 feet.

Table 1: Undrained (Short-term) Geotechnical Parameters for Design of S-P Wall, Sta. 119+82 to 121+36  
 Ref Borings: RW-06, RW-07, HA-RW-01, HA-RW-02, HA-NDB-10, HA-DB-11, NDB-09, and NDB-10

Soil Description Average Elevation (feet)	Unit Weight $\gamma$ (pcf)	Undrained Shear Strength Properties		Earth Pressure Coefficients	
		Cohesion (psf)	Friction Angle ( $^{\circ}$ )	Active Pressure (1V:2H)	Passive Pressure (straight)
M Stiff to V Stiff CLAY to SILTY CLAY FILL Surface to EL 630 feet	120	1500	0	1.00	--
Stiff to V Stiff SILTY CLAY EL 630 to 625 feet	120	2000	0	1.00	100
M Dense to Dense SILT to SILTY LOAM EL 625 to 618 feet	58 (submerged)	0	32	0.46	3.26

Soil Description Average Elevation (feet)	Unit Weight $\gamma$ (pcf)	Undrained Shear Strength Properties		Earth Pressure Coefficients	
		Cohesion (psf)	Friction Angle (°)	Active Pressure (1V:2H)	Passive Pressure (straight)
Stiff to Hard SILTY CLAY El 618 to 613 feet	63 (submerged)	3400	0	1.00	1.00
Dense to V Dense SAND/SILT EL 613 to 609 feet	63 (submerged)	0	35	0.38	3.69
Hard SILTY CLAY El 609 to 607 feet (EOB)	63 (submerged)	5300	0	1.00	1.00

Table 2: Undrained (Short-term) Geotechnical Parameters for Design of S-P Wall, Sta. 121+36 to 124+49  
 Ref Borings: RW-08 to RW-10, HA-RWB-03, and NDB-11 to NDB-14

Soil Description Average Elevation (feet)	Unit Weight $\gamma$ (pcf)	Undrained Shear Strength Properties		Earth Pressure Coefficients	
		Cohesion (psf)	Friction Angle (°)	Active Pressure (1V:2H)	Passive Pressure (straight)
Stiff to Hard CLAY to SILTY CLAY FILL Surface to Elevation 636 feet	120	2500	0	1.00	--
V Stiff to Hard CLAY to SILTY CLAY EL 636 to 629 feet	120	4500	0	1.00	1.00
Stiff to V Stiff CLAY to SILTY CLAY EL 629 to 624 feet	120	1600	0	1.00	1.00
Loose to M Dense SILT to SILTY LOAM EL 624 to 610 feet	53 (submerged)	0	29	0.59	2.88
Hard SILTY CLAY El 610 to 607 feet	63 (submerged)	5000	0	1.00	1.00
Dense to V Dense SAND/SILT EL 607 to 603 feet (EOB)	63 (submerged)	0	35	0.38	3.69

Table 3: Drained (Long-term) Geotechnical Parameters for Design of S-P Wall, Sta. 119+82 to 121+36  
 Ref Borings: RW-06, RW-07, HA-RW-01, HA-RW-02, HA-NDB-10, HA-DB-11, NDB-09, and NDB-10

Soil Description Average Elevation (feet)	Unit Weight $\gamma$ (pcf)	Drained Shear Strength Properties		Earth Pressure Coefficients	
		Cohesion (psf)	Friction Angle (°)	Active Pressure (1V:2H)	Passive Pressure (straight)
M Stiff to V Stiff CLAY to SILTY CLAY FILL Surface to EL 630 feet	120	100	30	0.54	--
Stiff to V Stiff SILTY CLAY EL 630 to 625 feet	120	100	30	0.54	3.00
M Dense to Dense SILT to SILTY LOAM EL 625 to 618 feet	58 (submerged)	0	32	0.47	3.26
Stiff to Hard SILTY CLAY El 618 to 613 feet	63 (submerged)	100	30	0.54	3.00
Dense to V Dense SAND/SILT EL 613 to 609 feet	63 (submerged)	0	35	0.38	3.69
Hard SILTY CLAY El 609 to 607 feet (EOB)	63 (submerged)	100	32	0.47	3.26

Table 4: Drained (Long-term) Geotechnical Parameters for Design of S-P Wall, Sta. 121+36 to 124+49  
 Ref Borings: RW-08 to RW-10, HA-RWB-03, and NDB-11 to NDB-14

Soil Description Average Elevation (feet)	Unit Weight $\gamma$ (pcf)	Drained Shear Strength Properties		Earth Pressure Coefficients	
		Cohesion (psf)	Friction Angle (°)	Active Pressure (1V:2H)	Passive Pressure (straight)
Stiff to Hard CLAY to SILTY CLAY FILL Surface to Elevation 636 feet	120	100	30	0.54	--
V Stiff to Hard CLAY to SILTY CLAY EL 636 to 629 feet	120	100	30	0.54	3.00
Stiff to V Stiff CLAY to SILTY CLAY EL 629 to 624 feet	120	100	30	0.54	3.00
Loose to M Dense SILT to SILTY LOAM EL 624 to 610 feet	53 (submerged)	0	29	0.59	2.88

Soil Description Average Elevation (feet)	Unit Weight $\gamma$ (pcf)	Drained Shear Strength Properties		Earth Pressure Coefficients	
		Cohesion (psf)	Friction Angle ( $^{\circ}$ )	Active Pressure (1V:2H)	Passive Pressure (straight)
Hard SILTY CLAY El 610 to 607 feet	63 (submerged)	100	32	0.47	3.26
Dense to V Dense SAND/SILT EL 607 to 603 feet (EOB)	63 (submerged)	0	35	0.38	3.69

The lateral deformation of the wall should be designed for movement and moment fixity at the base of the pile. The roadway, utilities, and any nearby structures should not be impacted by the lateral movement of the wall. Therefore, the design of the soldier pile wall should include the maximum allowable lateral wall deflection. The evaluations should be performed using the recommended soil parameters shown in Tables 5 and 6, based on station limits, via the p-y curve (COM624) method. Elevations provided in Tables 5 and 6 are based on the average layer elevations across the profile and may vary from one boring location to another.

Table 5: Recommended Geotechnical Parameters for Lateral Load Analysis, Sta. 119+82 to 121+36  
 Ref Borings: RW-06, RW-07, HA-RW-01, HA-RW-02, HA-NDB-10, HA-DB-11, NDB-09, and NDB-10

Soil Description Average Elevation (feet)	Unit Weight $\gamma$ (pcf)	Undrained Shear Strength $c_u$ (psf)	Estimated Friction Angle $\Phi$ ( $^{\circ}$ )	Estimated Lateral Soil Modulus Parameter k (pci)	Estimated Soil Strain Parameter $\epsilon_{50}$ (%)
M Stiff to V Stiff CLAY to SILTY CLAY FILL Surface to EL 630 feet	120	1500	0	500	0.7
Stiff to V Stiff SILTY CLAY EL 630 to 625 feet	120	2000	0	1000	0.5
M Dense to Dense SILT to SILTY LOAM EL 625 to 618 feet	58 (submerged)	0	32	60	--
Stiff to Hard SILTY CLAY El 618 to 613 feet	63 (submerged)	3400	0	1000	0.5
Dense to V Dense SAND/SILT EL 613 to 609 feet	63 (submerged)	0	35	120	--
Hard SILTY CLAY El 609 to 607 feet (EOB)	63 (submerged)	5300	0	2000	0.4

Table 6: Recommended Geotechnical Parameters for Lateral Load Analysis, Sta. 121+36 to 124+49  
 Ref Borings: RW-08 to RW-10, HA-RWB-03, and NDB-11 to NDB-14

Soil Description Average Elevation (feet)	Unit Weight $\gamma$ (pcf)	Undrained Shear Strength $c_u$ (psf)	Estimated Friction Angle $\Phi$ ( $^\circ$ )	Estimated Lateral Soil Modulus Parameter k (pci)	Estimated Soil Strain Parameter $\epsilon_{50}$ (%)
Stiff to Hard CLAY to SILTY CLAY FILL Surface to Elevation 636 feet	120	2500	0	1000	0.5
V Stiff to Hard CLAY to SILTY CLAY EL 636 to 629 feet	120	4500	0	2000	0.4
Stiff to V Stiff CLAY to SILTY CLAY EL 629 to 624 feet	120	1600	0	500	0.7
Loose to M Dense SILT to SILTY LOAM EL 624 to 610 feet	53 (submerged)	0	29	40	--
Hard SILTY CLAY El 610 to 607 feet	63 (submerged)	5000	0	2000	0.4
Dense to V Dense SAND/SILT EL 607 to 603 feet (EOB)	63 (submerged)	0	35	120	--

### 4.3 Global Stability

The global stability of the proposed wall was analyzed based on the soil profile described in Section 3.1 and the information provided in the GPE. The stability was analyzed at the critical section near Station 121+44 where the maximum exposed height is 8.0 feet. The minimum required factor of safety (FOS) is 1.7 in both short-term (undrained) and long-term (drained) conditions (IDOT 2015).

Details of the global stability analysis with critical failure surfaces and results are presented in Appendix C. We estimate the wall will have an adequate FOS of 8.4 (Appendix C-1) in the undrained condition. Global stability evaluations were performed to estimate the minimum pile tip elevation required to achieve an FOS of 1.7 in the drained condition as shown in Table 7. It should be noted that typically, the lateral earth pressure and deformation analyses will determine the minimum embedment depth for cantilevered pile wall. Therefore, the designer should perform other analyses including lateral earth pressure and deflection analyses to determine the required design pile embedment.

Table 7: Results of Global Stability Analysis

Station	Reference Boring(s)	Retained Wall Height (feet)	Short-term (Undrained) Condition		Long-term (Drained) Condition	
			FOS	Minimum Tip Elevation (feet)	FOS	Minimum Tip Elevation (feet)
121+44	HA-RW-02, HA-RW-08 RW-08, RW-09, NDB-12	8.0	8.4	--	1.7	634.4

## 5.0 CONSTRUCTION CONSIDERATIONS

### 5.1 Site Preparation

Vegetation, surface topsoil, debris, and any existing ditch sediment encountered should be cleared and stripped where the structure will be placed. If unstable or unsuitable materials are exposed during excavation, they should be removed and replaced with compacted fill as described in Section 5.3.

### 5.2 Excavation, Dewatering, and Utilities

Excavations should be performed in accordance with local, state, and federal regulations. The potential effect of ground movements upon nearby utilities should be considered during construction. Excavations deeper than 4 feet should be sloped at no steeper than 1:2 (V: H). Any slope that cannot be graded at 1:2 (V: H) should be properly shored. Excavated material should not be stockpiled immediately adjacent to the top of slopes.

Groundwater was encountered at elevations of 612 to 626 feet within the interbedded silt/sand layers. For drilled soldier piles installations, temporary casing and/or wet installation methods will be required. In addition, hard drilling should be anticipated during drilled soldier pile installation at or below 612 feet elevation.

### 5.3 Filling and Backfilling

Fill material used to attain final design elevations should be pre-approved, compacted; cohesive or granular soil conforming to IDOT Section 205, *Embankment* (2016). The fill material should be free of organic matter and debris and should be placed in lifts and compacted according to the Standard. Backfill materials must be pre-approved by the Resident Engineer. Backfill material should be placed and compacted in accordance with the Special Provision.

## **5.4 Earthwork Operations**

The required earthwork can be accomplished with conventional construction equipment. Moisture and traffic will cause deterioration of exposed subgrade soils. Precautions should be taken by the Contractor to prevent water erosion of the exposed subgrade. A compacted subgrade will minimize water runoff erosion.

Earth moving operations should be scheduled to not coincide with excessive cold or wet weather (early spring, late fall or winter). Any soil allowed to freeze or soften due to the standing water should be removed. Wet weather can cause problems with subgrade compaction.

It is recommended that an experienced geotechnical engineer be retained to inspect the exposed subgrade, monitor earthwork and soldier pile drilling operations, pile installation, and provide material inspection services during the construction phase of this project.

## **6.0 QUALIFICATIONS**

The analysis and recommendations submitted in this report are based upon the data obtained from the borings drilled at the locations shown on the boring logs and in Exhibit 3. This report does not reflect any variations that may occur between the borings or elsewhere on the site, variations whose nature and extent may not become evident until the course of construction. In the event that any changes in the design and/or location of the wall are planned, we should be timely informed so that our recommendations can be adjusted accordingly.

It has been a pleasure to assist Accurate Group, Inc. and the Illinois Department of Transportation on this project. Please call if there are any questions, or if we can be of further service.

Respectfully Submitted,

### **WANG ENGINEERING, INC.**

Andri Kurnia, P.E.  
Senior Geotechnical Engineer

Nesam S. Balakumaran, P.Eng.  
Project Geotechnical Engineer

Corina T. Farez, P.E., P.G.  
QA/QC Reviewer



## ***REFERENCES***

AMERICAN ASSOCIATION OF STATE HIGHWAY TRANSPORTATION OFFICIALS (20207) "AASHTO LRFD Bridge Design Specifications." United States Dept of Transportation, Washington, D.C.

IDOT (2012) *Bridge Manual*. Illinois Department of Transportation.

IDOT (2015) *Geotechnical Manual*. Illinois Department of Transportation.

IDOT (2016) *Standard Specifications for Road and Bridge Construction*. Illinois Department of Transportation, 1098 pp.

## **EXHIBITS**



US 14 BIKE PATH RETAINING WALL  
 SN 016-9201  
 NW 1/4 Sec. 17, T 41N, R 12E of 3rd P.M.

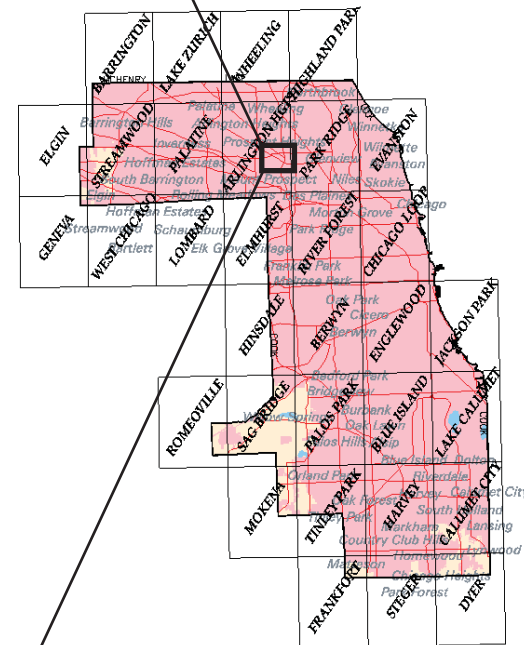

Cook County

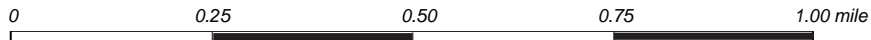

SITE LOCATION MAP: US 14 BIKE PATH RETAINING WALL,  
 SN 016-9201, DES PLAINES, COOK COUNTY, ILLINOIS

SCALE: GRAPHICAL	<b>EXHIBIT 1</b>	DRAWN BY: J. Bensen CHECKED BY: A. Kurmia
------------------	------------------	--



1145 N. Main Street  
 Lombard, IL 60148  
 www.wangeng.com

FOR ACCURATE GROUP, INC.	491-04-04
--------------------------	-----------

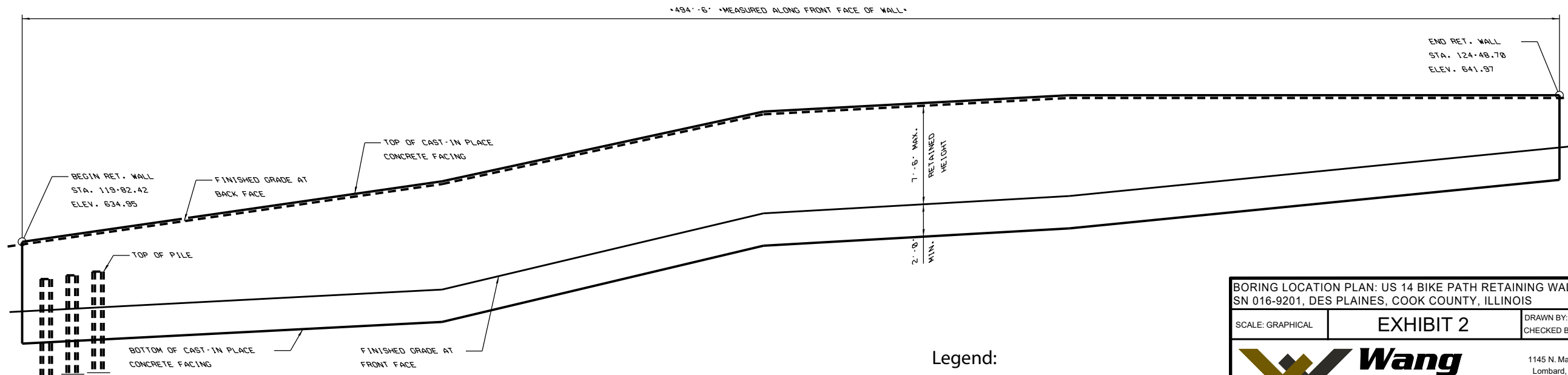

**ELEVATION**  
\*LOOKING AT FRONT FACE OF WALL\*

- Legend:**
- Soil Borings drilled in 2021
  - Soil Borings drilled in 2015

BORING LOCATION PLAN: US 14 BIKE PATH RETAINING WALL, SN 016-9201, DES PLAINES, COOK COUNTY, ILLINOIS		
SCALE: GRAPHICAL	<b>EXHIBIT 2</b>	DRAWN BY: J. Bensen CHECKED BY: A. Kurnia
		1145 N. Main Street Lombard, IL 60148 www.wangeng.com
		FOR ACCURATE GROUP, INC.      491-04-04

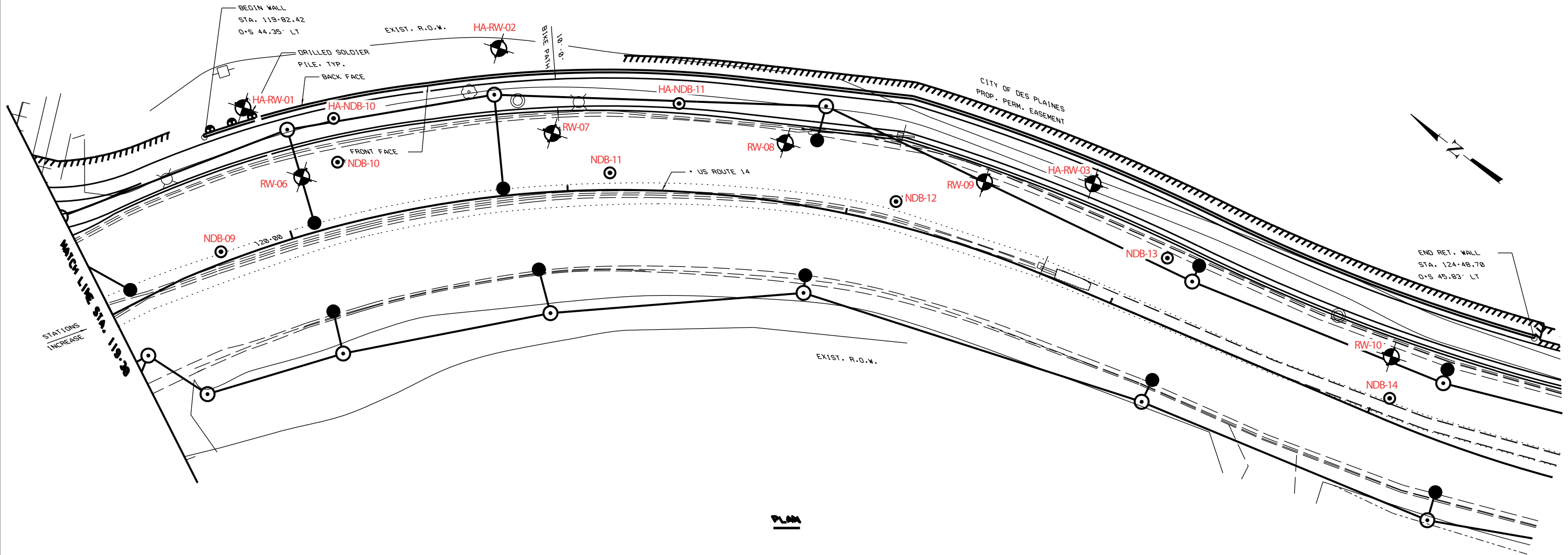

**PLAN**

FILE NAME = #FILEL#



USER NAME = #USER#	DESIGNED - SAT	REVISED -
PLOT SCALE = #SCALE#	CHECKED - JMT	REVISED -
PLOT DATE = #DATE#	DRAWN - SAT	REVISED -
	CHECKED - SPS	REVISED -

STATE OF ILLINOIS  
DEPARTMENT OF TRANSPORTATION

**RETAINING WALL FEASIBILITY STUDY - PLAN AND ELEVATION**  
**US ROUTE 14**  
SHEET NO. OF SHEETS

SECTION 11	COUNTY	TOTAL SHEETS	SHEET NO.
86 S-1-I	COOK		
CONTRACT NO. 60149			
ILLINOIS FED. AID PROJECT			



W

Top of Facia Panel

Finished Grade at F.F of Wall

E

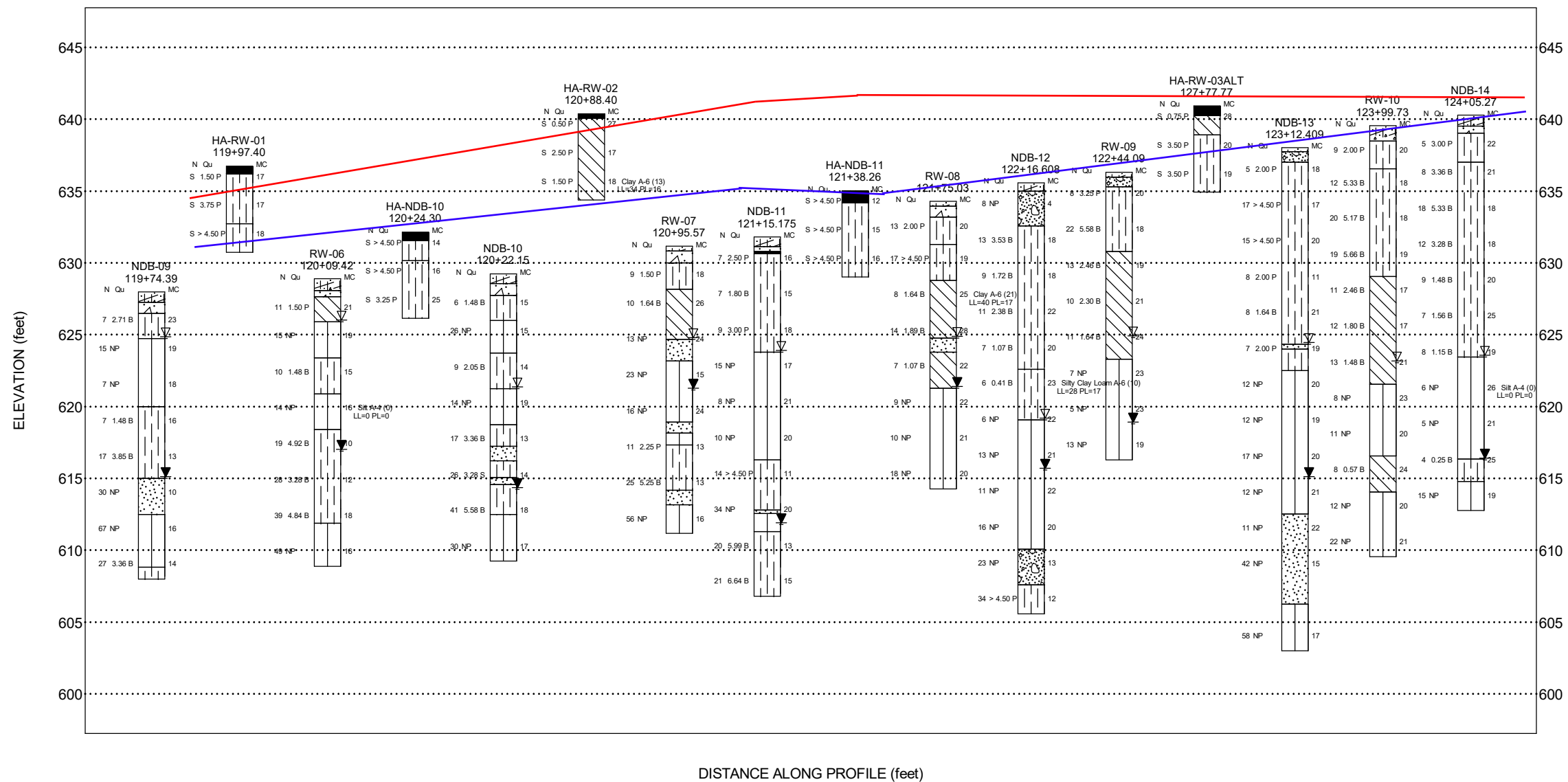

DISTANCE ALONG PROFILE (feet)

Lithology Graphics

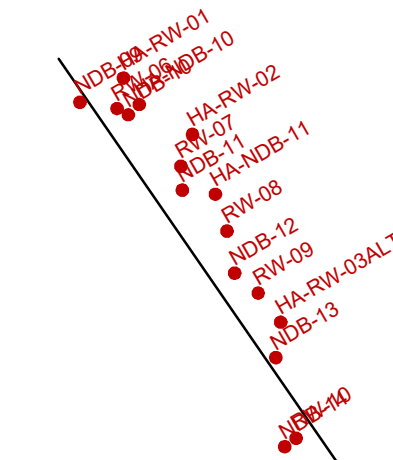
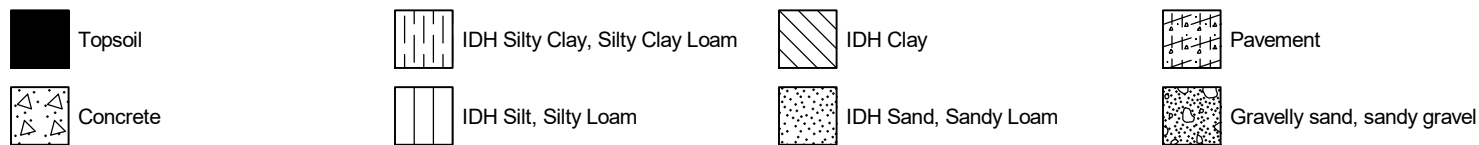

Site Map Scale 1 inch equals 200 feet

Explanation:

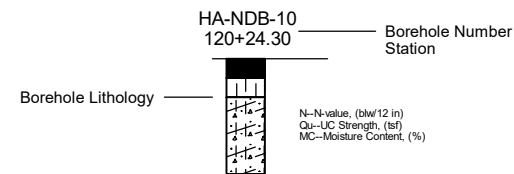

- ▽ Water Level Reading at time of drilling.
- ▼ Water Level Reading 24-hr after drilling or at end of drilling

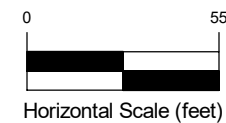

Horizontal Scale (feet)

Vertical Exaggeration: 6x

Wang Engineering, Inc.

1145 N. Main Street  
Lombard/IL/60148

Soil Profile  
US Route 14 Retaining Wall 2  
SN 016-9201



US 14 Bike Path Retaining Wall  
Cook County, Illinois

JOB NUMBER	PLATE NUMBER
491-04-04	EXHIBIT 3

## **APPENDIX A**



wangeng@wangeng.com  
 1145 N. Main Street  
 Lombard/IL/60148  
 Telephone: 6309539928  
 Fax: 6309539938

# BORING LOG HA-RW-01

WEI Job No.: 491-04-04

Client: **Accurate Group, Inc.**  
 Project: **US 14 Bike Path Retaining Wall**  
 Location: **Cook County, Illinois**

Datum: NAVD 88  
 Elevation: 636.73 ft  
 North: 1960057.89 ft  
 East: 1102680.00 ft  
 Station: 119+97.40  
 Offset: 50.183 LT

Profile	Elevation (ft)	SOIL AND ROCK DESCRIPTION	Depth (ft)	Sample Type recovery	Sample No.	SPT Values (blw/6 in)	Qu (tsf)	Moisture Content (%)	Profile	Elevation (ft)	SOIL AND ROCK DESCRIPTION	Depth (ft)	Sample Type recovery	Sample No.	SPT Values (blw/6 in)	Qu (tsf)	Moisture Content (%)
	636.2	6-inch thick, black SILTY CLAY LOAM --TOPSOIL-- Stiff to very stiff, brown and gray SILTY CLAY, trace gravel; damp --FILL--			1	P C S H	1.50 P	17									
					2	P C S H	3.75 P	17									
	632.7	Hard, brown and gray SILTY CLAY, trace gravel; damp	5		3	P C S H	4.50 P	18									
	630.7	Boring terminated at 6.00 ft															

### GENERAL NOTES

### WATER LEVEL DATA

Begin Drilling **03-10-2021** Complete Drilling **03-10-2021**  
 Drilling Contractor **Wang Testing Services** Drill Rig  
 Driller **R&J** Logger **F. Bozga** Checked by **J. Bensen**  
 Drilling Method **.1" ID HSA; boring backfilled upon completion**

While Drilling  $\nabla$  **DRY**  
 At Completion of Drilling  $\nabla$  **DRY**  
 Time After Drilling **NA**  
 Depth to Water  $\nabla$  **NA**

The stratification lines represent the approximate boundary between soil types; the actual transition may be gradual.



wangeng@wangeng.com  
 1145 N. Main Street  
 Lombard/IL/60148  
 Telephone: 6309539928  
 Fax: 6309539938

# BORING LOG HA-RW-02

WEI Job No.: 491-04-04

Client: **Accurate Group, Inc.**  
 Project: **US 14 Bike Path Retaining Wall**  
 Location: **Cook County, Illinois**

Datum: NAVD 88  
 Elevation: 640.39 ft  
 North: 1959998.63 ft  
 East: 1102752.45 ft  
 Station: 120+88.40  
 Offset: 52.465 LT

Profile	Elevation (ft)	SOIL AND ROCK DESCRIPTION	Depth (ft)	Sample Type recovery	Sample No.	SPT Values (blw/6 in)	Qu (tsf)	Moisture Content (%)	Profile	Elevation (ft)	SOIL AND ROCK DESCRIPTION	Depth (ft)	Sample Type recovery	Sample No.	SPT Values (blw/6 in)	Qu (tsf)	Moisture Content (%)
	640.14	14-inch thick, black SILTY CLAY LOAM --TOPSOIL-- Medium stiff to very stiff, brown and gray CLAY, trace gravel; damp	0.50	P C U S H	1	P C U S H	0.50	27									
		--FILL--	2.50	P C U S H	2	P C U S H	2.50	17									
	634.4	--L <sub>L</sub> (%)=34, P <sub>L</sub> (%)=16-- --%Gravel=5.4-- --%Sand=13.5-- --%Silt=46.6-- --%Clay=34.5-- --A-6 (13)-- Boring terminated at 6.00 ft	1.50	P C U S H	3	P C U S H	1.50	18									

### GENERAL NOTES

### WATER LEVEL DATA

Begin Drilling **03-10-2021** Complete Drilling **03-10-2021**  
 Drilling Contractor **Wang Testing Services** Drill Rig .....  
 Driller **R&J** Logger **F. Bozga** Checked by **J. Bensen**  
 Drilling Method **.1" ID HSA; boring backfilled upon completion**

While Drilling  $\nabla$  **DRY**  
 At Completion of Drilling  $\nabla$  **DRY**  
 Time After Drilling **NA**  
 Depth to Water  $\nabla$  **NA**

The stratification lines represent the approximate boundary between soil types; the actual transition may be gradual.





wangeng@wangeng.com  
 1145 N. Main Street  
 Lombard/IL/60148  
 Telephone: 6309539928  
 Fax: 6309539938

# BORING LOG HA-RW-03

WEI Job No.: 491-04-04

Client: **Accurate Group, Inc.**  
 Project: **US 14 Bike Path Retaining Wall**  
 Location: **Cook County, Illinois**

Datum: NAVD 88  
 Elevation: 640.92 ft  
 North: 1959801.42 ft  
 East: 1102845.09 ft  
 Station: 127+77.77  
 Offset: 37.171 LT

Profile	Elevation (ft)	SOIL AND ROCK DESCRIPTION	Depth (ft)	Sample Type recovery	Sample No.	SPT Values (blw/6 in)	Qu (tsf)	Moisture Content (%)	Profile	Elevation (ft)	SOIL AND ROCK DESCRIPTION	Depth (ft)	Sample Type recovery	Sample No.	SPT Values (blw/6 in)	Qu (tsf)	Moisture Content (%)
	640.3	8-inch thick, black SILTY CLAY LOAM --TOPSOIL--			1	P C S H	0.75 P	28									
	638.9	Medium stiff, brown CLAY, trace gravel; damp --FILL--			2	P C S H	3.50 P	20									
	634.9	Very stiff, brown SILTY CLAY, trace gravel; damp	5		3	P C S H	3.50 P	19									
		Boring terminated at 6.00 ft	10														
			15														
			20														

### GENERAL NOTES

### WATER LEVEL DATA

Begin Drilling **03-10-2021** Complete Drilling **03-10-2021**  
 Drilling Contractor **Wang Testing Services** Drill Rig  
 Driller **R&J** Logger **F. Bozga** Checked by **J. Bensen**  
 Drilling Method **.1" ID HSA; boring backfilled upon completion**

While Drilling  $\nabla$  **DRY**  
 At Completion of Drilling  $\nabla$  **DRY**  
 Time After Drilling **NA**  
 Depth to Water  $\nabla$  **NA**

The stratification lines represent the approximate boundary between soil types; the actual transition may be gradual.



wangeng@wangeng.com  
 1145 N. Main Street  
 Lombard/IL/60148  
 Telephone: 6309539928  
 Fax: 6309539938

# BORING LOG RW-06

WEI Job No.: 491-04-04

Client: **Accurate Group, Inc.**  
 Project: **US 14 Bike Path Retaining Wall**  
 Location: **Cook County, Illinois**

Datum: NAVD 88  
 Elevation: 628.88 ft  
 North: 1960025.86 ft  
 East: 1102673.19 ft  
 Station: 120+09.42  
 Offset: 20.156 LT

Profile	Elevation (ft)	SOIL AND ROCK DESCRIPTION	Depth (ft)	Sample Type recovery	Sample No.	SPT Values (blw/6 in)	Qu (tsf)	Moisture Content (%)	Profile	Elevation (ft)	SOIL AND ROCK DESCRIPTION	Depth (ft)	Sample Type recovery	Sample No.	SPT Values (blw/6 in)	Qu (tsf)	Moisture Content (%)
	628.1	9.5-inch thick ASPHALT --PAVEMENT--															
	627.65	6.5-inch thick CONCRETE --PAVEMENT--															
	625.9	Stiff, brown and gray CLAY, trace gravel; damp --FILL--			1	6 6 5	1.50 P	21									
		Medium dense, gray SILT; wet --RDR 2--			2	4 7 8	NP	19									
	623.4	Stiff, gray SILTY CLAY LOAM, trace gravel; damp --RDR 2--			3	3 4 6	1.48 B	15									
	620.9	Medium dense, gray SILT; moist --RDR 2-- --%Gravel=0.0-- --%Sand=7.8-- --%Silt=85.2-- --%Clay=6.9-- --A-4 (0)--			4	2 6 8	NP	16									
	618.4	Very stiff to hard, gray SILTY CLAY LOAM to SILTY CLAY, trace gravel; damp --RDR 2--  --1-inch thick silt seams--			5	5 8 11	4.92 B	10									
					6	8 14 14	3.28 B	12									
	611.9	Dense, gray SILT; wet --RDR 2--			7	6 14 25	4.84 B	18									
					8	12 26 23	NP	16									
	608.9	Boring terminated at 20.00 ft															

### GENERAL NOTES

### WATER LEVEL DATA

Begin Drilling **03-09-2021** Complete Drilling **03-09-2021**  
 Drilling Contractor **Wang Testing Services** Drill Rig **20D50T [80%]**  
 Driller **R&J** Logger **F. Bozga** Checked by **J. Bensen**  
 Drilling Method **2.25" ID HSA; boring backfilled upon completion**

While Drilling  $\nabla$  **3.00 ft**  
 At Completion of Drilling  $\nabla$  **12.00 ft**  
 Time After Drilling **NA**  
 Depth to Water  $\nabla$  **NA**

The stratification lines represent the approximate boundary between soil types; the actual transition may be gradual.

WANGENGINC 4910404.GPJ WANGENG.GDT 3/30/21



wangeng@wangeng.com  
 1145 N. Main Street  
 Lombard/IL/60148  
 Telephone: 6309539928  
 Fax: 6309539938

# BORING LOG RW-07

WEI Job No.: 491-04-04

Client: **Accurate Group, Inc.**  
 Project: **US 14 Bike Path Retaining Wall**  
 Location: **Cook County, Illinois**

Datum: NAVD 88  
 Elevation: 631.16 ft  
 North: 1959965.16 ft  
 East: 1102740.24 ft  
 Station: 120+95.57  
 Offset: 20.921 LT

Profile	Elevation (ft)	SOIL AND ROCK DESCRIPTION	Depth (ft)	Sample Type recovery	Sample No.	SPT Values (blw/6 in)	Qu (tsf)	Moisture Content (%)	Profile	Elevation (ft)	SOIL AND ROCK DESCRIPTION	Depth (ft)	Sample Type recovery	Sample No.	SPT Values (blw/6 in)	Qu (tsf)	Moisture Content (%)
	630.84	1-inch thick ASPHALT --PAVEMENT--															
	630.0	10-inch thick CONCRETE --PAVEMENT--															
		Stiff, brown SILTY CLAY; damp --FILL--			1	4 4 5	1.50 P	18									
	628.2	Stiff, gray CLAY, trace gravel; damp --RDR 2--			2	3 4 6	1.64 B	26									
	624.7	Medium dense, gray, fine SAND; wet --RDR 2--			3	4 5 8	NP	24									
	623.2	Medium dense, gray SILT; damp to saturated --RDR 2--			4	9 11 12	NP	15									
	618.9	Gray, coarse SAND; wet			5	5 7 9	NP	24									
	618.2	Medium dense, gray SILT; saturated			6	6 5 6	2.25 P	13									
	617.3	Very stiff to hard, gray SILTY CLAY LOAM, trace gravel; damp --RDR 2--			7	6 10 15	5.25 B	13									
	614.2	Gray SAND; saturated			8	15 27 29	NP	16									
	613.2	Very dense, gray SILT; wet															
	611.2	Boring terminated at 20.00 ft	20														

### GENERAL NOTES

Begin Drilling **03-08-2021** Complete Drilling **03-08-2021**  
 Drilling Contractor **Wang Testing Services** Drill Rig **20D50T [80%]**  
 Driller **R&J** Logger **F. Bozga** Checked by **J. Bensen**  
 Drilling Method **2.25" ID HSA; boring backfilled upon completion**

### WATER LEVEL DATA

While Drilling  $\nabla$  **6.50 ft**  
 At Completion of Drilling  $\nabla$  **10.00 ft**  
 Time After Drilling **NA**  
 Depth to Water  $\nabla$  **NA**

The stratification lines represent the approximate boundary between soil types; the actual transition may be gradual.

WANGENGINC 4910404.GPJ WANGENG.GDT 3/30/21



wangeng@wangeng.com  
 1145 N. Main Street  
 Lombard/IL/60148  
 Telephone: 6309539928  
 Fax: 6309539938

# BORING LOG RW-08

WEI Job No.: 491-04-04

Client: **Accurate Group, Inc.**  
 Project: **US 14 Bike Path Retaining Wall**  
 Location: **Cook County, Illinois**

Datum: NAVD 88  
 Elevation: 634.27 ft  
 North: 1959897.16 ft  
 East: 1102788.74 ft  
 Station: 121+75.03  
 Offset: 21.073 LT

Profile	Elevation (ft)	SOIL AND ROCK DESCRIPTION	Depth (ft)	Sample Type recovery	Sample No.	SPT Values (blw/6 in)	Qu (tsf)	Moisture Content (%)	Profile	Elevation (ft)	SOIL AND ROCK DESCRIPTION	Depth (ft)	Sample Type recovery	Sample No.	SPT Values (blw/6 in)	Qu (tsf)	Moisture Content (%)
	633.94	1-inch thick ASPHALT --PAVEMENT--															
	633.2	9-inch thick CONCRETE --PAVEMENT--															
		Very stiff, brown SILTY CLAY; damp			1	4 6 7	2.00 P	20									
	631.3	--FILL-- Hard, brown SILTY CLAY, trace gravel; damp			2	4 7 10	4.50 P	19									
	628.8	Stiff, gray CLAY, trace gravel; damp			3	3 4 4	1.64 B	25									
		--RDR 2-- --L <sub>L</sub> (%)=40, P <sub>L</sub> (%)=17-- --%Gravel=2.2-- --%Sand=6.9-- --%Silt=44.6-- --%Clay=46.3-- --A-6 (21)--			4	3 7 7	1.89 B	28									
	624.8	Gray, fine SAND; wet	10		5	2 3 4	1.07 B	22									
	623.8	Stiff, gray CLAY; moist --1-inch thick silt seams; wet--			6	2 3 6	NP	22									
	621.3	Loose to medium dense, gray SILT; saturated			7	4 5 5	NP	21									
		--RDR 2--	15		8	5 8 10	NP	20									
	614.3	Boring terminated at 20.00 ft	20														

### GENERAL NOTES

### WATER LEVEL DATA

Begin Drilling **03-08-2021** Complete Drilling **03-08-2021**  
 Drilling Contractor **Wang Testing Services** Drill Rig **20D50T [80%]**  
 Driller **R&J** Logger **F. Bozga** Checked by **J. Bensen**  
 Drilling Method **2.25" ID HSA; boring backfilled upon completion**

While Drilling  $\nabla$  **9.50 ft**  
 At Completion of Drilling  $\nabla$  **13.00 ft**  
 Time After Drilling **NA**  
 Depth to Water  $\nabla$  **NA**

The stratification lines represent the approximate boundary between soil types; the actual transition may be gradual.



wangeng@wangeng.com  
 1145 N. Main Street  
 Lombard/IL/60148  
 Telephone: 6309539928  
 Fax: 6309539938

# BORING LOG RW-09

WEI Job No.: 491-04-04

Client: **Accurate Group, Inc.**  
 Project: **US 14 Bike Path Retaining Wall**  
 Location: **Cook County, Illinois**

Datum: NAVD 88  
 Elevation: 636.30 ft  
 North: 1959831.99 ft  
 East: 1102821.46 ft  
 Station: 122+44.09  
 Offset: 23.647 LT

Profile	Elevation (ft)	SOIL AND ROCK DESCRIPTION	Depth (ft)	Sample Type recovery	Sample No.	SPT Values (blw/6 in)	Qu (tsf)	Moisture Content (%)	Profile	Elevation (ft)	SOIL AND ROCK DESCRIPTION	Depth (ft)	Sample Type recovery	Sample No.	SPT Values (blw/6 in)	Qu (tsf)	Moisture Content (%)
	636.04	1/4" -inch thick ASPHALT --PAVEMENT--															
	635.3	Brown and gray SANDY GRAVEL --BASE COURSE-- Very stiff to hard, brown SILTY CLAY, trace gravel; damp --RDR 2--	5		1	6 5 3	3.25 P	20									
			5		2	5 10 12	5.58 B	18									
	630.8	Stiff to very stiff, gray CLAY, trace gravel; damp --RDR 2--			3	3 5 8	2.46 B	19									
					4	3 4 6	2.30 B	21									
		--2-inch thick silt seam; wet--			5	3 5 6	1.64 B	24									
	623.3	Loose to medium dense, gray SILT; saturated --RDR 1--			6	2 3 4	NP	23									
					7	2 2 3	NP	23									
					8	4 6 7	NP	19									
	616.3	Boring terminated at 20.00 ft	20														

### GENERAL NOTES

### WATER LEVEL DATA

Begin Drilling **03-08-2021** Complete Drilling **03-08-2021**  
 Drilling Contractor **Wang Testing Services** Drill Rig **20D50T [80%]**  
 Driller **R&J** Logger **F. Bozga** Checked by **J. Bensen**  
 Drilling Method **2.25" ID HSA; boring backfilled upon completion**

While Drilling  $\nabla$  **11.50 ft**  
 At Completion of Drilling  $\nabla$  **17.50 ft**  
 Time After Drilling **NA**  
 Depth to Water  $\nabla$  **NA**

The stratification lines represent the approximate boundary between soil types; the actual transition may be gradual.

WANGENGINC 4910404.GPJ WANGENG.GDT 3/30/21



wangeng@wangeng.com  
 1145 N. Main Street  
 Lombard/IL/60148  
 Telephone: 6309539928  
 Fax: 6309539938

# BORING LOG RW-10

WEI Job No.: 491-04-04

Client: **Accurate Group, Inc.**  
 Project: **US 14 Bike Path Retaining Wall**  
 Location: **Cook County, Illinois**

Datum: NAVD 88  
 Elevation: 639.56 ft  
 North: 1959679.55 ft  
 East: 1102861.34 ft  
 Station: 123+99.73  
 Offset: 21.582 LT

Profile	Elevation (ft)	SOIL AND ROCK DESCRIPTION	Depth (ft)	Sample Type recovery	Sample No.	SPT Values (blw/6 in)	Qu (tsf)	Moisture Content (%)	Profile	Elevation (ft)	SOIL AND ROCK DESCRIPTION	Depth (ft)	Sample Type recovery	Sample No.	SPT Values (blw/6 in)	Qu (tsf)	Moisture Content (%)	
	638.5	13-inch thick ASPHALT --PAVEMENT--																
	636.6	Very stiff, brown and gray SILTY CLAY, trace gravel; damp --FILL--			1	2 4 5	2.00 P	20						9	4 6 5		NP	20
		Hard, brown SILTY CLAY, trace gravel; damp --RDR 2--	5		2	4 5 7	5.33 B	18		616.6	Medium stiff, gray CLAY, few silt seams; saturated --RDR 1--	25		10	1 3 5	0.57 B		24
					3	5 8 12	5.17 B	18		614.1	Medium dense, gray SILT; damp to saturated			11	5 7 5		NP	20
			10		4	5 8 11	5.66 B	19						12	6 9 13		NP	21
	629.1	Stiff to very stiff, gray CLAY, trace gravel; damp --RDR 2--			5	4 5 6	2.46 B	17		609.6	Boring terminated at 30.00 ft	30						
			15		6	4 5 7	1.80 B	17				35						
		--1.5-inch thick silt seams; wet--			7	4 7 6	1.48 B	21										
	621.6	Loose to medium dense, gray SILT; saturated --RDR 1--			8	3 4 4	NP	23				40						

### GENERAL NOTES

Begin Drilling **03-08-2021** Complete Drilling **03-08-2021**  
 Drilling Contractor **Wang Testing Services** Drill Rig **20D50T [80%]**  
 Driller **R&J** Logger **F. Bozga** Checked by **J. Bensen**  
 Drilling Method **2.25" ID HSA; boring backfilled upon completion**

### WATER LEVEL DATA

While Drilling  $\nabla$  **16.50 ft**  
 At Completion of Drilling  $\nabla$  **DRY**  
 Time After Drilling **NA**  
 Depth to Water  $\nabla$  **NA**

The stratification lines represent the approximate boundary between soil types; the actual transition may be gradual.

WANGENGINC 4910404.GPJ WANGENG.GDT 3/30/21



wangeng@wangeng.com  
 1145 N. Main Street  
 Lombard/IL/60148  
 Telephone: 6309539928  
 Fax: 6309539938

# BORING LOG HA-NDB-10

WEI Job No.: 491-02-03

Client ..... **Accurate Group, Inc.** .....  
 Project ..... **US 14 under CN/UP RR** .....  
 Location ..... **Des Plaines, IL** .....

Datum: NAVD  
 Elevation: 632.14 ft  
 North: 1960030.03 ft  
 East: 1102696.51 ft  
 Station: 120+24.30  
 Offset: 37.66 LT

Profile	Elevation (ft)	SOIL AND ROCK DESCRIPTION	Depth (ft)	Sample Type recovery	Sample No.	SPT Values (blw/6 in)	Qu (tsf)	Moisture Content (%)	Profile	Elevation (ft)	SOIL AND ROCK DESCRIPTION	Depth (ft)	Sample Type recovery	Sample No.	SPT Values (blw/6 in)	Qu (tsf)	Moisture Content (%)
	631.6	7-inch thick, dark brown SILTY LOAM --TOPSOIL--			1	P C S H	> 4.50	14									
	630.1	Hard, brown SILTY CLAY, trace gravel --FILL--			2	P C S H	> 4.50	16									
		Very stiff to hard, gray SILTY CLAY, trace gravel	5		3	P C S H	3.25	25									
	626.1	Boring terminated at 6.00 ft															

### GENERAL NOTES

### WATER LEVEL DATA

Begin Drilling ..... **09-02-2015** ..... Complete Drilling ..... **09-02-2015** .....  
 Drilling Contractor ..... **Wang Testing Services** ..... Drill Rig .....  
 Driller ..... **R&K** ..... Logger ..... **D. Kolpacki** ..... Checked by ..... **B. Wilson** .....  
 Drilling Method ..... **.1" IDA Pneumatic Geoprobe LB Sampler** .....

While Drilling ..... ▽ ..... **DRY** .....  
 At Completion of Drilling ..... ▼ ..... **DRY** .....  
 Time After Drilling ..... **NA** .....  
 Depth to Water ..... ▼ ..... **NA** .....

The stratification lines represent the approximate boundary between soil types; the actual transition may be gradual.



wangeng@wangeng.com  
 1145 N. Main Street  
 Lombard/IL/60148  
 Telephone: 6309539928  
 Fax: 6309539938

# BORING LOG HA-NDB-11

WEI Job No.: 491-02-03

Client ..... **Accurate Group, Inc.** .....  
 Project ..... **US 14 under CN/UP RR** .....  
 Location ..... **Des Plaines, IL** .....

Datum: NAVD  
 Elevation: 635.02 ft  
 North: 1959935.81 ft  
 East: 1102776.54 ft  
 Station: 121+38.26  
 Offset: 31.43 LT

Profile	Elevation (ft)	SOIL AND ROCK DESCRIPTION	Depth (ft)	Sample Type recovery	Sample No.	SPT Values (blw/6 in)	Qu (tsf)	Moisture Content (%)	Profile	Elevation (ft)	SOIL AND ROCK DESCRIPTION	Depth (ft)	Sample Type recovery	Sample No.	SPT Values (blw/6 in)	Qu (tsf)	Moisture Content (%)
	634.2	10-inch thick, dark brown SILTY LOAM			1	P C S H	> 4.50	12									
		--TOPSOIL-- Hard, brown SILTY CLAY, trace gravel			2	P C S H	> 4.50	15									
	629.0		5		3	P C S H	> 4.50	16									
		Boring terminated at 6.00 ft															
			10														
			15														
			20														

### GENERAL NOTES

### WATER LEVEL DATA

Begin Drilling ..... **09-02-2015** ..... Complete Drilling ..... **09-02-2015** .....  
 Drilling Contractor ..... **Wang Testing Services** ..... Drill Rig .....  
 Driller ..... **R&K** ..... Logger ..... **D. Kolpacki** ..... Checked by ..... **B. Wilson** .....  
 Drilling Method ..... **.1" IDA Pneumatic Geoprobe LB Sampler** .....

While Drilling ..... ▽ ..... **DRY** .....  
 At Completion of Drilling ..... ▼ ..... **DRY** .....  
 Time After Drilling ..... **NA** .....  
 Depth to Water ..... ▼ ..... **NA** .....

The stratification lines represent the approximate boundary between soil types; the actual transition may be gradual.





wangeng@wangeng.com  
 1145 N. Main Street  
 Lombard/IL/60148  
 Telephone: 6309539928  
 Fax: 6309539938

# BORING LOG NDB-09

WEI Job No.: 491-02-03

Client **Accurate Group, Inc.**  
 Project **US 14 under CN/UP RR**  
 Location **Des Plaines, IL**

Datum: NAVD  
 Elevation: 627.99 ft  
 North: 1960032.50 ft  
 East: 1102634.19 ft  
 Station: 119+74.39  
 Offset: 3.92 LT

Profile	Elevation (ft)	SOIL AND ROCK DESCRIPTION	Depth (ft)	Sample Type recovery	Sample No.	SPT Values (blw/6 in)	Qu (tsf)	Moisture Content (%)	Profile	Elevation (ft)	SOIL AND ROCK DESCRIPTION	Depth (ft)	Sample Type recovery	Sample No.	SPT Values (blw/6 in)	Qu (tsf)	Moisture Content (%)
	627.2	9-inch thick, ASPHALT --PAVEMENT--									Boring terminated at 20.00 ft						
	626.5	9-inch thick, CONCRETE --PAVEMENT--															
	624.7	Very stiff, gray SILTY CLAY, trace gravel		X	1	3 2 5	2.71 B	23									
		Loose to medium dense, gray SILT to SILTY LOAM, interbedded sand and clay --Saturated--	5	X	2	4 5 10	NP	19									
				X	3	2 3 4	NP	18									
	620.0	Stiff to very stiff, gray SILTY CLAY, trace gravel		X	4	3 3 4	1.48 B	16									
			10	X	5	6 7 10	3.85 B	13									
	615.0	Dense, gray, coarse SAND, some gravel --Saturated--		X	6	16 19 11	NP	10									
	612.5	Very dense, gray SILT to SILTY LOAM --Wet--		X	7	18 27 40	NP	16									
	608.8	--Saturated--		X	8	24 13 14	3.36 B	14									
	608.0	Very stiff, gray SILTY CLAY, trace gravel	20	X													

### GENERAL NOTES

### WATER LEVEL DATA

Begin Drilling **09-03-2015** Complete Drilling **09-03-2015**  
 Drilling Contractor **Wang Testing Services** Drill Rig  
 Driller **R&K** Logger **D. Kolpacki** Checked by **B. Wilson**  
 Drilling Method **3.25 IDA HSA; Backfilled upon completion**

While Drilling  $\nabla$  **3.25 ft**  
 At Completion of Drilling  $\nabla$  **13.00 ft**  
 Time After Drilling **NA**  
 Depth to Water  $\nabla$  **NA**

The stratification lines represent the approximate boundary between soil types; the actual transition may be gradual.

WANGENG 4910203.GPJ WANGENG.GDT 3/24/21



wangeng@wangeng.com  
 1145 N. Main Street  
 Lombard/IL/60148  
 Telephone: 6309539928  
 Fax: 6309539938

# BORING LOG NDB-10

WEI Job No.: 491-02-03

Client ..... **Accurate Group, Inc.** .....  
 Project ..... **US 14 under CN/UP RR** .....  
 Location ..... **Des Plaines, IL** .....

Datum: NAVD  
 Elevation: 629.23 ft  
 North: 1960019.25 ft  
 East: 1102685.01 ft  
 Station: 120+22.15  
 Offset: 22.07 LT

Profile	Elevation (ft)	SOIL AND ROCK DESCRIPTION	Depth (ft)	Sample Type recovery	Sample No.	SPT Values (blw/6 in)	Qu (tsf)	Moisture Content (%)	Profile	Elevation (ft)	SOIL AND ROCK DESCRIPTION	Depth (ft)	Sample Type recovery	Sample No.	SPT Values (blw/6 in)	Qu (tsf)	Moisture Content (%)
	628.6	8-inch thick, ASPHALT --PAVEMENT--															
	627.7	10-inch thick, CONCRETE --PAVEMENT--															
	626.0	Stiff, gray SILTY CLAY, trace gravel		X	1	3 3 3	1.48 B	15									
	623.7	Medium dense, gray SILT --Damp--		X	2	12 12 14	NP	15									
	621.2	Very stiff, gray SILTY CLAY LOAM, trace gravel		X	3	3 4 5	2.05 B	14									
	618.7	Medium dense, gray SILT, interbedded very fine sand --Saturated--		X	4	5 7 7	NP	19									
	617.2	Very stiff, gray SILTY CLAY LOAM, trace gravel		X	5	5 8 9	3.36 B	13									
	616.2	Medium dense, gray, fine SAND --Saturated--															
	615.1	Very stiff, gray SILTY CLAY, trace gravel		X	6	6 15 11	3.28 S	14									
	614.6	Medium dense, gray, coarse SAND, some gravel		X	6												
	612.5	Hard, gray SILTY CLAY, trace gravel		X	7	8 19 22	5.58 B	18									
	609.2	Dense, gray SILT --Saturated--		X	8	20 17 13	NP	17									
Boring terminated at 20.00 ft																	

## GENERAL NOTES

## WATER LEVEL DATA

Begin Drilling ..... **09-02-2015** ..... Complete Drilling ..... **09-02-2015** .....  
 Drilling Contractor ..... **Wang Testing Services** ..... Drill Rig .....  
 Driller ..... **R&K** ..... Logger ..... **D. Kolpacki** ..... Checked by ..... **B. Wilson** .....  
 Drilling Method ..... **3.25 IDA HSA; Backfilled upon completion** .....

While Drilling ..... ▽ ..... **8.00 ft** .....  
 At Completion of Drilling ..... ▼ ..... **15.00 ft** .....  
 Time After Drilling ..... **NA** .....  
 Depth to Water ..... ▼ ..... **NA** .....

The stratification lines represent the approximate boundary between soil types; the actual transition may be gradual.



wangeng@wangeng.com  
 1145 N. Main Street  
 Lombard/IL/60148  
 Telephone: 6309539928  
 Fax: 6309539938

# BORING LOG NDB-11

WEI Job No.: 491-02-03

Client ..... **Accurate Group, Inc.** .....  
 Project ..... **US 14 under CN/UP RR** .....  
 Location ..... **Des Plaines, IL** .....

Datum: NGVD  
 Elevation: 631.80 ft  
 North: 1959940.11 ft  
 East: 1102741.81 ft  
 Station: 121+15.175  
 Offset: LT 6.112

Profile	Elevation (ft)	SOIL AND ROCK DESCRIPTION	Depth (ft)	Sample Type recovery	Sample No.	SPT Values (blw/6 in)	Qu (tsf)	Moisture Content (%)	Profile	Elevation (ft)	SOIL AND ROCK DESCRIPTION	Depth (ft)	Sample Type recovery	Sample No.	SPT Values (blw/6 in)	Qu (tsf)	Moisture Content (%)
	631.1	8-inch thick, ASPHALT --PAVEMENT--								611.3	Dense, gray SILTY LOAM, trace gravel						
	630.8	4-inch thick, CONCRETE --PAVEMENT--			1	5 4 3	2.50 P	16			Hard, gray SILTY CLAY, trace gravel			9	6 9 11	5.99 B	13
	630.64	2-inch thick, black SILTY LOAM, trace organic matter --BURIED TOPSOIL--															
		Stiff to very stiff, gray SILTY CLAY, trace gravel			2	5 4 3	1.80 B	15		606.8		25		10	6 9 12	6.64 B	15
											Boring terminated at 25.00 ft						
					3	4 4 5	3.00 P	18									
	623.8	Loose to medium dense, gray SILT --Wet--			4	2 7 8	NP	17									
					5	3 4 4	NP	21									
		--Sand lenses--															
					6	4 4 6	NP	20									
	616.3	Hard, gray SILTY CLAY, trace gravel			7	6 6 8	4.50 P	11									
		--Sand lenses--															
	612.8	3-inch thick, gray medium SAND --Wet--			8	9 12 22	NP	20									
	612.63																

### GENERAL NOTES

### WATER LEVEL DATA

Begin Drilling ..... **07-07-2015** ..... Complete Drilling ..... **07-07-2015** .....  
 Drilling Contractor ..... **Wang Testing Services** ..... Drill Rig .....  
 Driller ..... **K&R** ..... Logger ..... **A. Tomaras** ..... Checked by ..... **B. Wilson** .....  
 Drilling Method ..... **3.25 IDA HSA; Backfilled upon completion** .....

While Drilling ..... ▽ ..... **8.00 ft** .....  
 At Completion of Drilling ..... ▼ ..... **20.00 ft** .....  
 Time After Drilling ..... **NA** .....  
 Depth to Water ..... ▼ ..... **NA** .....

The stratification lines represent the approximate boundary between soil types; the actual transition may be gradual.

WANGENGINC 4910203.GPJ WANGENG.GDT 3/24/21



wangeng@wangeng.com  
 1145 N. Main Street  
 Lombard/IL/60148  
 Telephone: 6309539928  
 Fax: 6309539938

# BORING LOG NDB-12

WEI Job No.: 491-02-03

Client: **Accurate Group, Inc.**  
 Project: **US 14 under CN/UP RR**  
 Location: **Des Plaines, IL**

Datum: NGVD  
 Elevation: 635.58 ft  
 North: 1959852.91 ft  
 East: 1102796.66 ft  
 Station: 122+16.608  
 Offset: LT 8.298

Profile	Elevation (ft)	SOIL AND ROCK DESCRIPTION	Depth (ft)	Sample Type recovery	Sample No.	SPT Values (blw/6 in)	Qu (tsf)	Moisture Content (%)	Profile	Elevation (ft)	SOIL AND ROCK DESCRIPTION	Depth (ft)	Sample Type recovery	Sample No.	SPT Values (blw/6 in)	Qu (tsf)	Moisture Content (%)
	635.0	7-inch thick, ASPHALT --PAVEMENT--															
		Loose, brown SANDY GRAVEL --BASE COURSE--			1	9 4 4	NP	4						9	3 4 7	NP	22
	632.6	Stiff to very stiff, gray SILTY CLAY, trace gravel			2	4 6 7	3.53 B	18						10	6 8 8	NP	20
		--Sand lenses--															
					3	4 4 5	1.72 B	18		610.1	Medium dense, gray GRAVEL --Saturated--			11	6 10 13	NP	13
					4	3 4 7	2.38 B	22		607.6	Hard, gray SILTY CLAY, trace gravel			12	7 12 22	4.50 P	12
					5	1 3 4	1.07 B	20		605.6	Boring terminated at 30.00 ft						
		--Silt lenses--															
	622.6	Soft, gray SILTY CLAY, silt lenses			6	2 3 3	0.41 B	23									
	619.1	Loose to medium dense, gray SILT --Saturated--			7	1 3 3	NP	22									
					8	2 6 7	NP	21									

### GENERAL NOTES

### WATER LEVEL DATA

Begin Drilling **07-07-2015** Complete Drilling **07-07-2015**  
 Drilling Contractor **Wang Testing Services** Drill Rig  
 Driller **K&R** Logger **A. Tomaras** Checked by **B. Wilson**  
 Drilling Method **3.25 IDA HSA; Backfilled upon completion**

While Drilling  $\nabla$  **16.50 ft**  
 At Completion of Drilling  $\nabla$  **20.00 ft**  
 Time After Drilling **NA**  
 Depth to Water  $\nabla$  **NA**

The stratification lines represent the approximate boundary between soil types; the actual transition may be gradual.

WANGENGINC 4910203.GPJ WANGENG.GDT 3/24/21



wangeng@wangeng.com  
 1145 N. Main Street  
 Lombard/IL/60148  
 Telephone: 6309539928  
 Fax: 6309539938

# BORING LOG NDB-13

WEI Job No.: 491-02-03

Client: **Accurate Group, Inc.**  
 Project: **US 14 under CN/UP RR**  
 Location: **Des Plaines, IL**

Datum: NAVD  
 Elevation: 638.01 ft  
 North: 1959764.25 ft  
 East: 1102840.06 ft  
 Station: 123+12.409  
 Offset: LT 22.762

Profile	Elevation (ft)	SOIL AND ROCK DESCRIPTION	Depth (ft)	Sample Type recovery	Sample No.	SPT Values (blw/6 in)	Qu (tsf)	Moisture Content (%)	Profile	Elevation (ft)	SOIL AND ROCK DESCRIPTION	Depth (ft)	Sample Type recovery	Sample No.	SPT Values (blw/6 in)	Qu (tsf)	Moisture Content (%)
	637.83	3-inch thick, ASPHALT --PAVEMENT--															
	637.0	9-inch thick, SANDY GRAVEL --BASE COURSE--															
		Stiff to hard, brown to gray SILTY CLAY, trace gravel			1	4 2 3	2.00 P	18						9	6 8 9	NP	20
					2	4 7 10	4.50 P	17						10	4 4 8	NP	21
		--Sand lenses--			3	3 7 8	4.50 P	20		612.5	Medium dense to dense, gray fine SANDY LOAM --Saturated--			11	2 5 6	NP	22
		--Sand and silt lenses--			4	3 4 4	2.00 P	11			--Wet--			12	11 20 22	NP	15
					5	3 4 4	1.64 B	21		606.3	Very dense, gray SILTY LOAM --Moist--						
	624.3	4-inch thick, gray, coarse SAND --Wet--			6	2 4 3	2.00 P	19						13	15 26 32	NP	17
	624.04	Very stiff, gray SILTY CLAY, trace gravel			15					603.0	Boring terminated at 35.00 ft						
	622.5	Medium dense, gray SILT to SILTY LOAM --Saturated--			7	4 6 6	NP	20									
					8	5 6 6	NP	19									

### GENERAL NOTES

### WATER LEVEL DATA

Begin Drilling: **07-06-2015** Complete Drilling: **07-06-2015**  
 Drilling Contractor: **Wang Testing Services** Drill Rig: \_\_\_\_\_  
 Driller: **K&R** Logger: **A. Tomaras** Checked by: **B. Wilson**  
 Drilling Method: **3.25 IDA HSA; Backfilled upon completion**

While Drilling: **13.67 ft**  
 At Completion of Drilling: **23.00 ft**  
 Time After Drilling: **NA**  
 Depth to Water: **NA**

The stratification lines represent the approximate boundary between soil types; the actual transition may be gradual.



wangeng@wangeng.com  
 1145 N. Main Street  
 Lombard/IL/60148  
 Telephone: 6309539928  
 Fax: 6309539938

# BORING LOG NDB-14

WEI Job No.: 491-02-03

Client ..... **Accurate Group, Inc.** .....  
 Project ..... **US 14 under CN/UP RR** .....  
 Location ..... **Des Plaines, IL** .....

Datum: NAVD  
 Elevation: 640.27 ft  
 North: 1959670.64 ft  
 East: 1102849.33 ft  
 Station: 124+05.27  
 Offset: LT 7.686

Profile	Elevation (ft)	SOIL AND ROCK DESCRIPTION	Depth (ft)	Sample Type recovery	Sample No.	SPT Values (blw/6 in)	Qu (tsf)	Moisture Content (%)	Profile	Elevation (ft)	SOIL AND ROCK DESCRIPTION	Depth (ft)	Sample Type recovery	Sample No.	SPT Values (blw/6 in)	Qu (tsf)	Moisture Content (%)
	639.5	9-inch thick, ASPHALT --PAVEMENT--															
	639.0	6-inch thick, CONCRETE --PAVEMENT--															
		Very stiff, brown SILTY CLAY --FILL--		X	1	3 2 3	3.00 P	22					X	9	2 2 3		NP 21
	637.0	Stiff to hard, brown to gray SILTY CLAY, trace gravel		X	2	2 4 4	3.36 B	21		616.4	Soft, gray SILTY CLAY, silt lenses		X	10	2 2 2	0.25 B	25
				X	3	5 7 11	5.33 B	18		614.8	Medium dense, gray SILTY LOAM --Wet--		X	11	3 7 8		NP 19
				X	4	4 5 7	3.28 B	18			Boring terminated at 27.50 ft						
				X	5	3 4 5	1.48 B	20									
				X	6	2 3 4	1.56 B	25									
	623.4	Loose, gray SILT --Saturated--		X	7	2 4 4	1.15 B	19									
				X	8	3 3 3	NP	26									

### GENERAL NOTES

### WATER LEVEL DATA

Begin Drilling ..... **07-02-2015** ..... Complete Drilling ..... **07-02-2015** .....  
 Drilling Contractor ..... **Wang Testing Services** ..... Drill Rig .....  
 Driller ..... **K&R** ..... Logger ..... **A. Tomaras** ..... Checked by ..... **B. Wilson** .....  
 Drilling Method ..... **2.25 IDA HSA; Backfilled upon completion** .....

While Drilling ..... ▽ ..... **16.83 ft** .....  
 At Completion of Drilling ..... ▼ ..... **24.00 ft** .....  
 Time After Drilling ..... **NA** .....  
 Depth to Water ..... ▼ ..... **NA** .....

The stratification lines represent the approximate boundary between soil types; the actual transition may be gradual.

WANGENGINC 4910203.GPJ WANGENG.GDT 3/24/21

## **APPENDIX B**

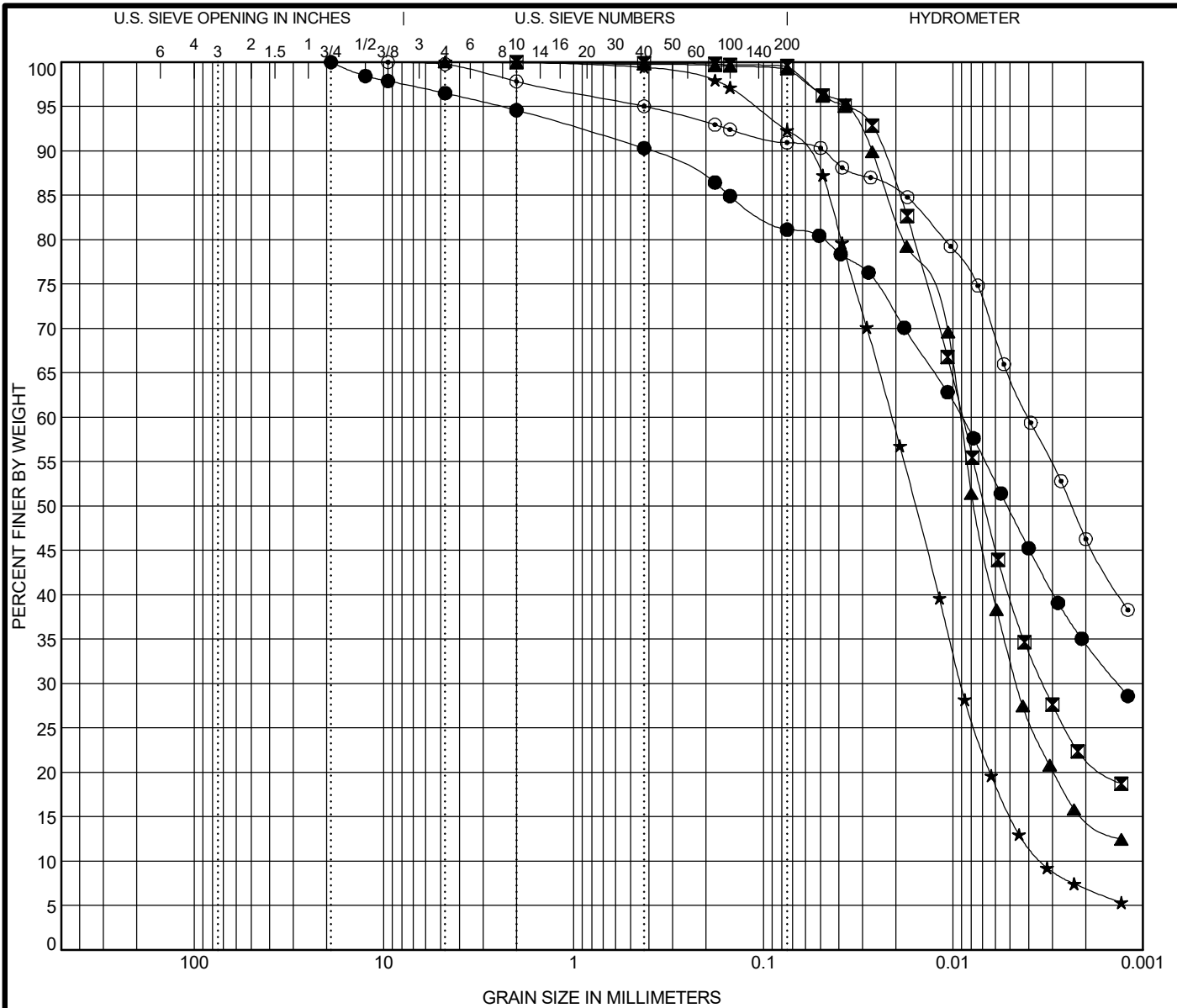

COBBLES	GRAVEL	SAND		SILT AND CLAY
		coarse	fine	

Specimen Identification			IDH Classification					LL	PL	PI	Cc	Cu
●	HA-RW-02#3	4.0 ft	Clay					34	16	18		
■	NDB-12#6	13.5 ft	Silty Clay Loam					28	17	11		
▲	NDB-14#8	18.5 ft	Silt					NP	NP	NP		
★	RW-06#4	8.5 ft	Silt					NP	NP	NP	1.16	6.14
○	RW-08#3	6.0 ft	Clay					40	17	23		
Specimen Identification			D100	D60	D30	D10	%Gravel	%Sand	%Silt	%Clay		
●	HA-RW-02#3	4.0 ft	19	0.009	0.001		5.4	13.5	46.6	34.5		
■	NDB-12#6	13.5 ft	2	0.009	0.003		0.0	0.5	77.8	21.7		
▲	NDB-14#8	18.5 ft	4.75	0.009	0.005		0.0	0.8	84.2	15.0		
★	RW-06#4	8.5 ft	4.75	0.021	0.009	0.003	0.0	7.8	85.2	6.9		
○	RW-08#3	6.0 ft	9.5	0.004			2.2	6.9	44.6	46.3		

WEI GRAIN SIZE IDH 4910404.GPJ US LAB.GDT 3/26/21



Wang Engineering, Inc.  
 1145 N. Main Street  
 Lombard/IL/60148  
 Telephone: 6309539928  
 Fax: 6309539938

**GRAIN SIZE DISTRIBUTION**

Project: US 14 Bike Path Retaining Wall  
 Location: Cook County, Illinois  
 Number: 491-04-04





## **APPENDIX C**

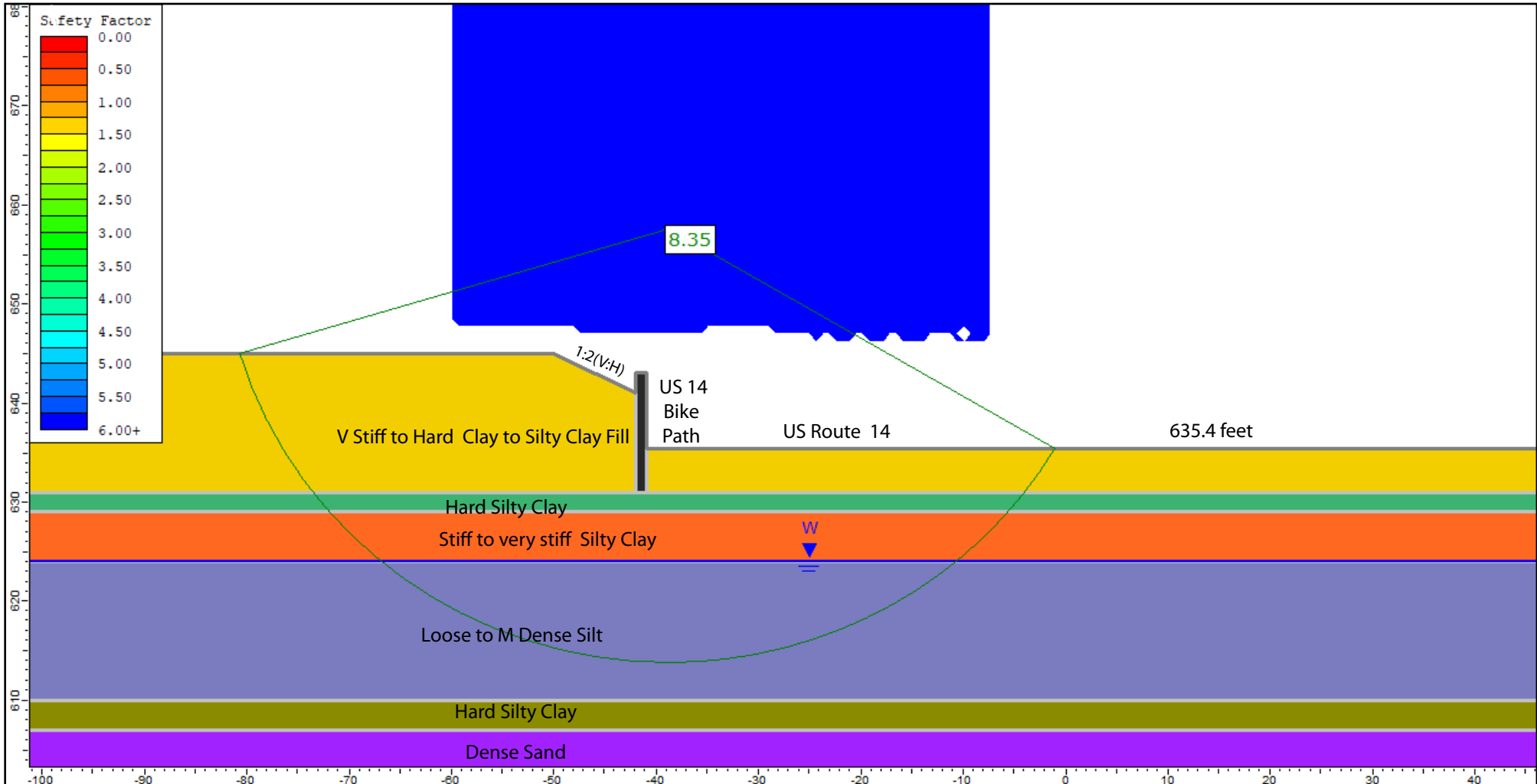

Undrained Analysis, Station 121+43, Ref Borings: HA-RW-02, HA-RW-08, RW-08, RW-09, and NDB-12

Layer ID	Description	Total Unit Weight (pcf)	Undrained Cohesion (psf)	Undrained Friction Angle (degrees)
1	V Stiff to Hard Clay to Silty Clay Fill	120	2500	0
2	Hard Silty Clay	120	4500	0
3	Stiff to Very stiff Silty Clay	120	1600	0
4	Loose to M Dense Silt	115	0	29
5	Hard Silty Clay	125	5000	0

GLOBAL STABILITY: US ROUTE 14 BIKE PATH RETAINING WALL, SN 016-9201, COOK COUNTY, IL

SCALE: GRAPHICAL | APPENDIX C-1 | DRAWN BY: N. Balakumaran | CHECKED BY: A. Kurnia



FOR ACCURATE GROUP, INC. | 498-04-04

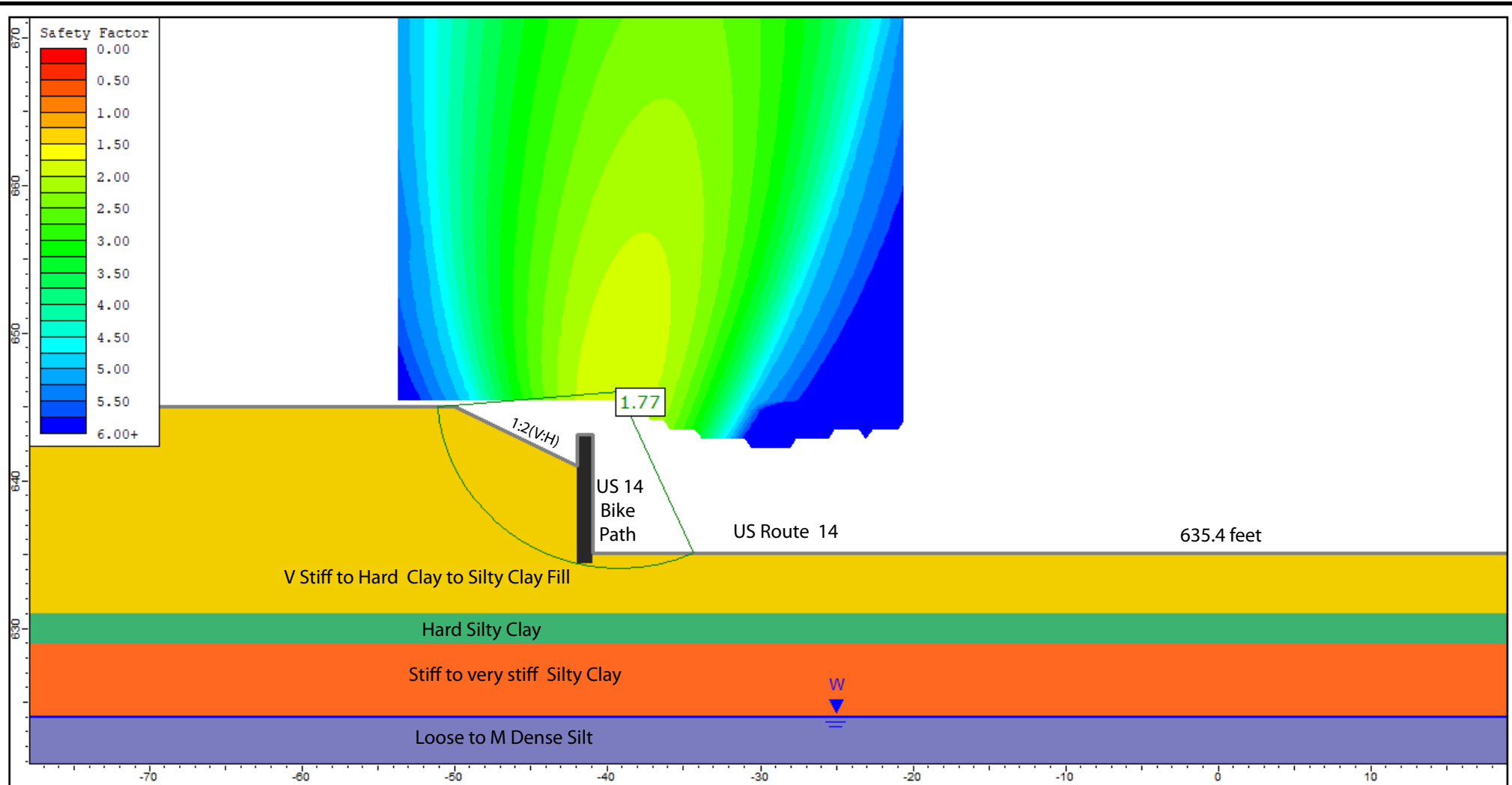

Drained Analysis, Station 121+43, Ref Borings: HA-RW-02, HA-RW-08, RW-08, RW-09, and NDB-12

Layer ID	Description	Total Unit Weight (pcf)	Drained Cohesion (psf)	Drained Friction Angle (degrees)
1	V Stiff to Hard Clay to Silty Clay Fill	120	100	30
2	Hard Silty Clay	120	100	30
3	Stiff to Very stiff Silty Clay	120	100	30
4	Loose to M Dense Silt	115	0	29
5	Hard Silty Clay	125	100	30

GLOBAL STABILITY: US ROUTE 14 BIKE PATH RETAINING WALL, SN 016-9201, COOK COUNTY, IL

SCALE: GRAPHICAL

APPENDIX C-2

DRAWN BY: N. Balakumaran  
CHECKED BY: A. Kurnia



1145 N. Main Street  
Lombard, IL 60148  
www.wangeng.com

FOR ACCURATE GROUP, INC.

498-04-04

## **APPENDIX D**

Benchmark: Temp Benchmark #1 set chiseled "x" on top of 6" concrete barrier curb at southeast corner of existing dayton freight parking lot adjacent to the existing pump station no. 8 elevation 643.93 (highway datum).

Traffic Control: xx

Existing Structure: None

**DESIGN SPECIFICATIONS**

2020 AASHTO LRFD Bridge Design Specifications, 9th Edition

**DESIGN STRESSES**

FIELD UNITS  
 f'c = 3,500 psi  
 fy = 60,000 psi (Reinforcement)  
 fy = 50,000 psi (M270 Grade 50)

**CURVE DATA**

P.I. Sta. = 121+26.99  
 Δ = 46° 04' 26" (RT)  
 D = 14° 27' 41"  
 R = 396.20'  
 T = 168.48'  
 L = 318.60'  
 E = 34.33'  
 e = -----  
 T.R. = -----  
 S.E. Run = -----  
 P.C. Sta. = 119+58.51  
 P.T. Sta. = 122+77.11

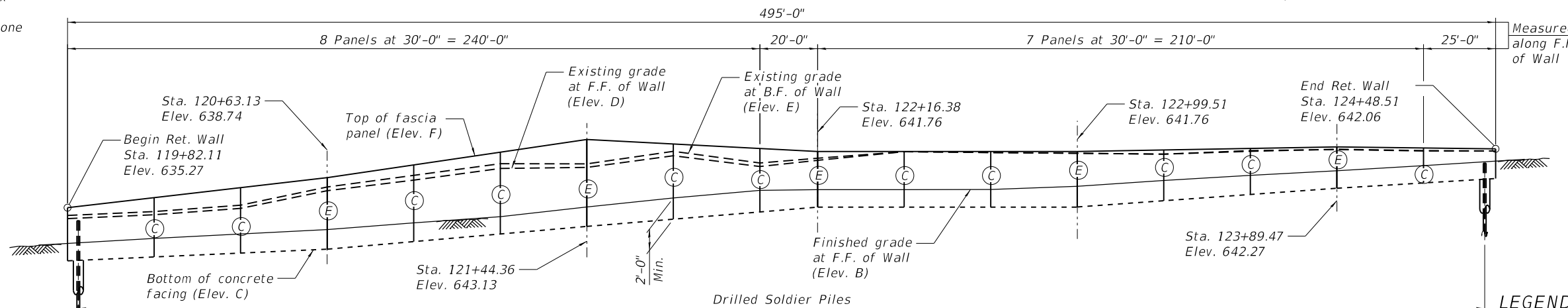

**LEGEND**

- Exist. Underground Telephone
- Exist. Underground Gas
- Exist. Underground Electric
- Exist. Underground Water Main
- Exist. Storm Sewer
- Prop. Storm Sewer
- ◆ Boring Location
- Prop. Catch Basin
- ⊙ Exist. Manhole
- ⊙ Prop. Manhole
- ⊙ Exist. Light Pole

**HIGHWAY CLASSIFICATION**

FAU Rte. 3512  
 Functional Class: Minor Arterial  
 ADT: 16100 (2019)  
 ADTT: 5% (2019)  
 DHV: 1288  
 Design Speed: 30 m.p.h.  
 Posted Speed: 30 m.p.h.  
 Two-Way Traffic  
 Directional Distribution: 50/50

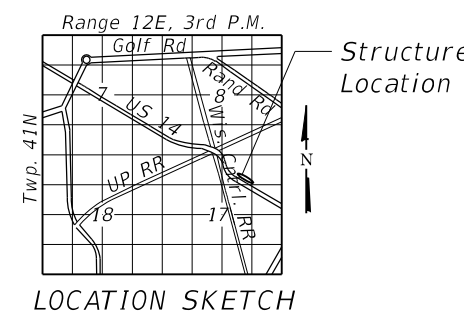
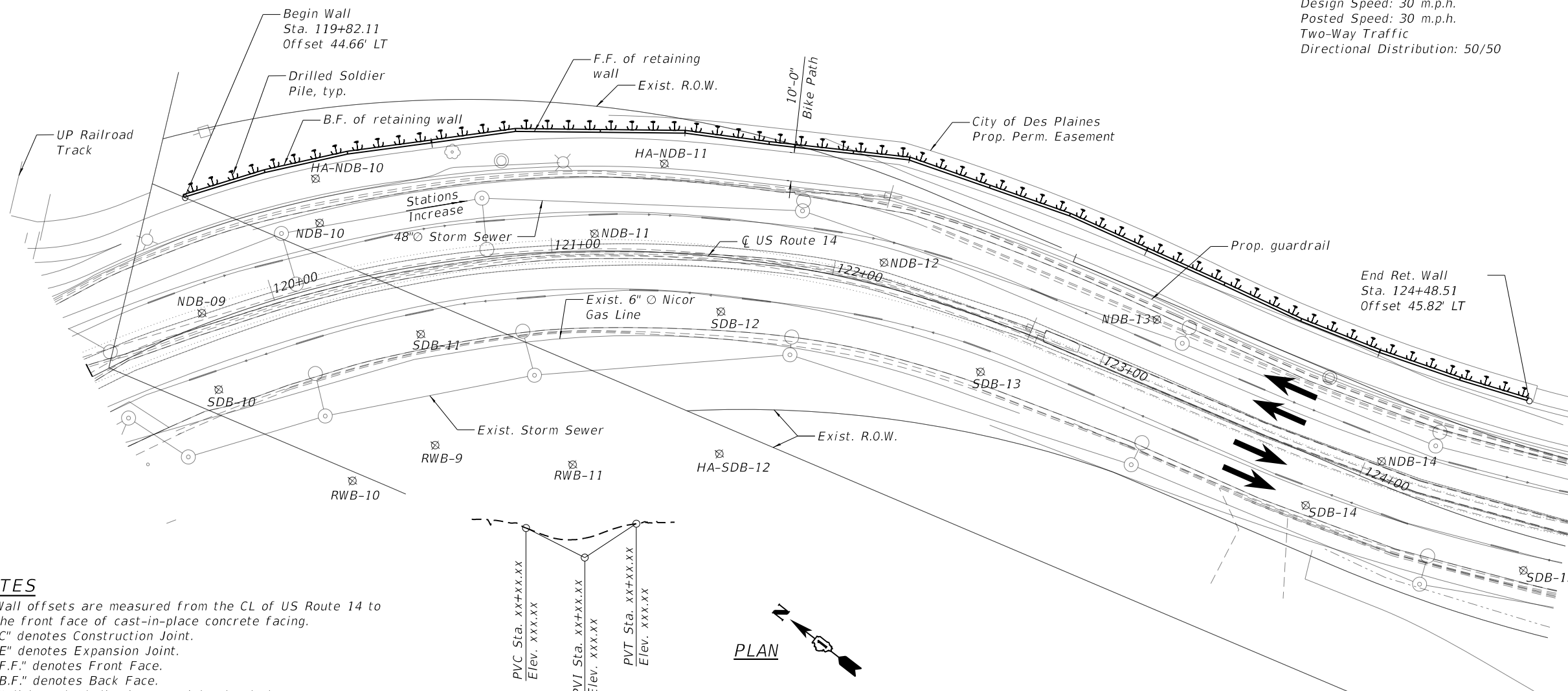

**NOTES**

1. Wall offsets are measured from the CL of US Route 14 to the front face of cast-in-place concrete facing.
2. "C" denotes Construction Joint.
3. "E" denotes Expansion Joint.
4. "F.F." denotes Front Face.
5. "B.F." denotes Back Face.
6. Wall is to be built along straight chords between construction joints.
7. Shaft diameter, pile section, spacing, top and tip elevations to be determined during final design.

**PROFILE GRADE**

(Left EOP WB US Route 14)

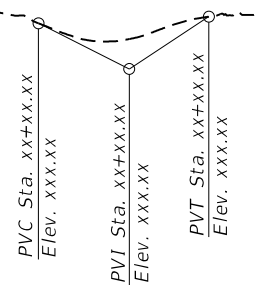

STATE OF ILLINOIS  
 DEPARTMENT OF TRANSPORTATION

STRUCTURE NO. 016-9201

FAU RTE.	SECTION	COUNTY	TOTAL SHEETS	SHEET NO.
3512	2018-109-RS, SW&T	COOK	\$TOTAL	1
CONTRACT NO. 62H38				



USER NAME =	DESIGNED - JA	REVISED -
PLOT SCALE =	CHECKED - MI, MAI	REVISED -
PLOT DATE =	DRAWN - JA	REVISED -
	DATE - \$DATE	REVISED -

SHEET 1 OF #1TOT SHEETS

ILLINOIS FED. AID PROJECT

MODEL: \$MODELNAME\$  
 FILE NAME: \$FILES\$  
 \$DATE\$ \$TIME\$

TABLE 1 - WALL ELEVATIONS

Station	Offset	Elevation A	Elevation B	Elevation C	Elevation D	Elevation E	Elevation F
119+82.11	44.66' Lt.	634.90	631.14	629.14	634.01	634.38	635.27
120+09.08	44.29' Lt.	635.36	631.73	629.59	634.45	634.83	636.43
120+36.09	43.61' Lt.	636.63	632.24	630.04	635.18	635.56	637.58
120+63.13	42.46' Lt.	638.29	632.74	630.49	637.22	637.65	638.74
120+90.19	43.37' Lt.	639.83	633.52	631.36	638.45	639.00	640.21
121+17.25	41.97' Lt.	641.22	634.23	632.23	639.79	640.35	641.67
121+44.36	42.62' Lt.	640.95	635.35	633.10	639.91	640.33	643.13
121+71.47	41.66' Lt.	641.65	636.39	633.94	641.26	641.77	642.62
121+98.52	43.40' Lt.	641.38	637.27	634.78	640.02	640.43	642.10
122+16.38	45.70' Lt.	641.38	637.34	635.34	640.72	640.98	641.76
122+43.29	44.08' Lt.	641.38	637.35	635.34	641.73	641.73	641.76
122+70.28	44.50' Lt.	641.38	637.37	635.34	641.63	641.63	641.76
122+99.51	43.84' Lt.	641.38	637.74	635.34	641.55	641.55	641.76
123+29.50	43.24' Lt.	641.38	638.40	636.06	641.44	641.44	641.93
123+59.48	42.11' Lt.	641.49	639.00	636.79	641.85	641.77	642.10
123+89.47	42.85' Lt.	641.90	639.53	637.51	641.98	642.01	642.27
124+20.92	44.68' Lt.	641.78	640.12	638.12	641.82	641.85	642.16
124+48.51	45.82' Lt.	641.68	640.64	638.62	641.82	641.80	642.06

Elevation A - Gutter Flow Line  
 Elevation B - Finished Grade at F.F. of Wall  
 Elevation C - Bottom of Fascia Panel  
 Elevation D - Existing Grade at F.F. of Wall  
 Elevation E - Existing Grade at B.F. of Wall  
 Elevation F - Top of Fascia Panel

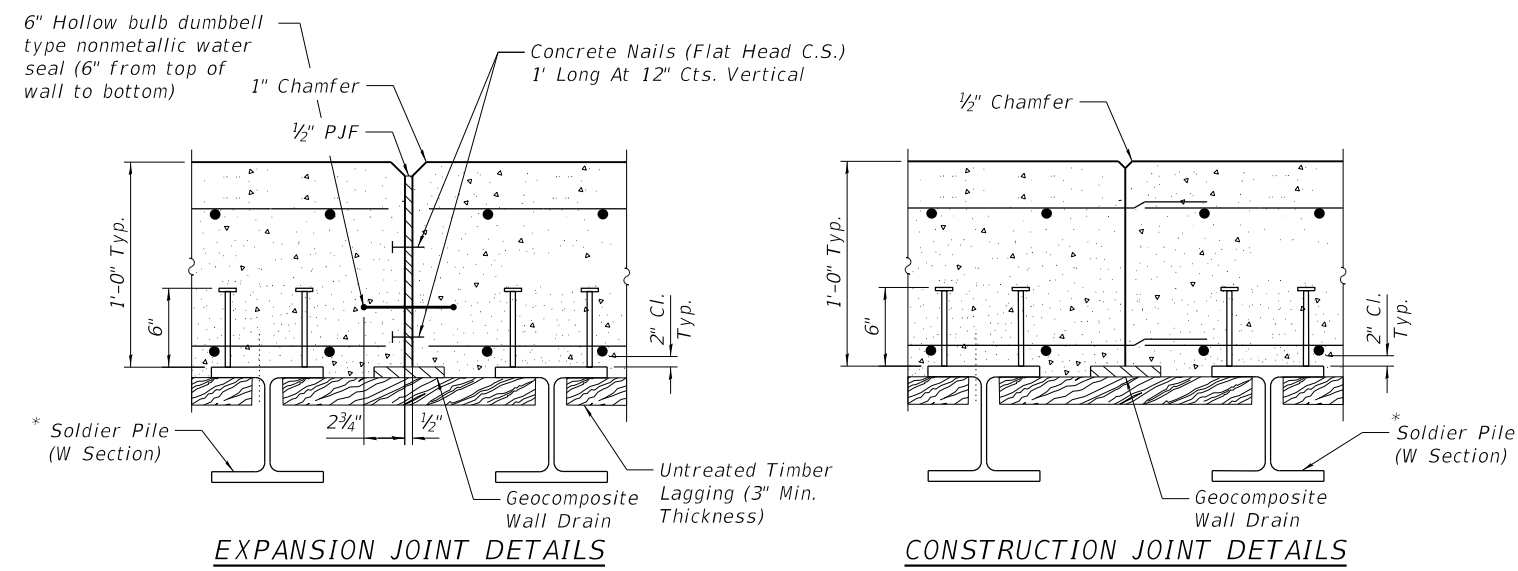
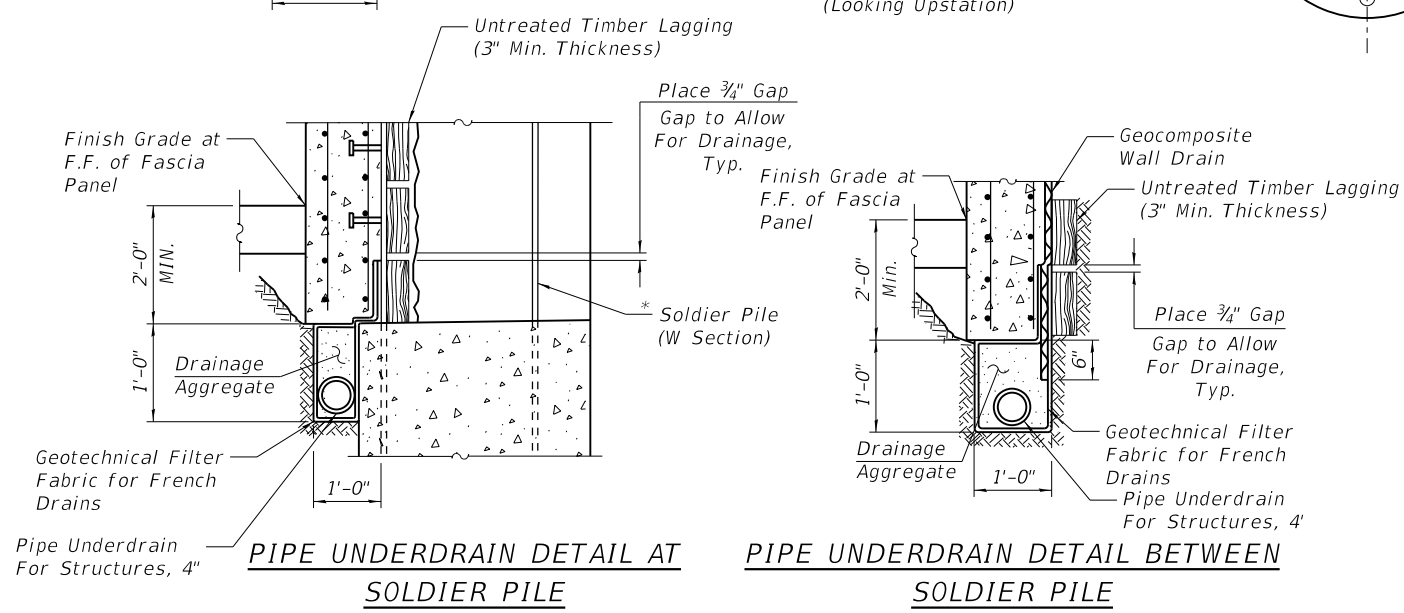
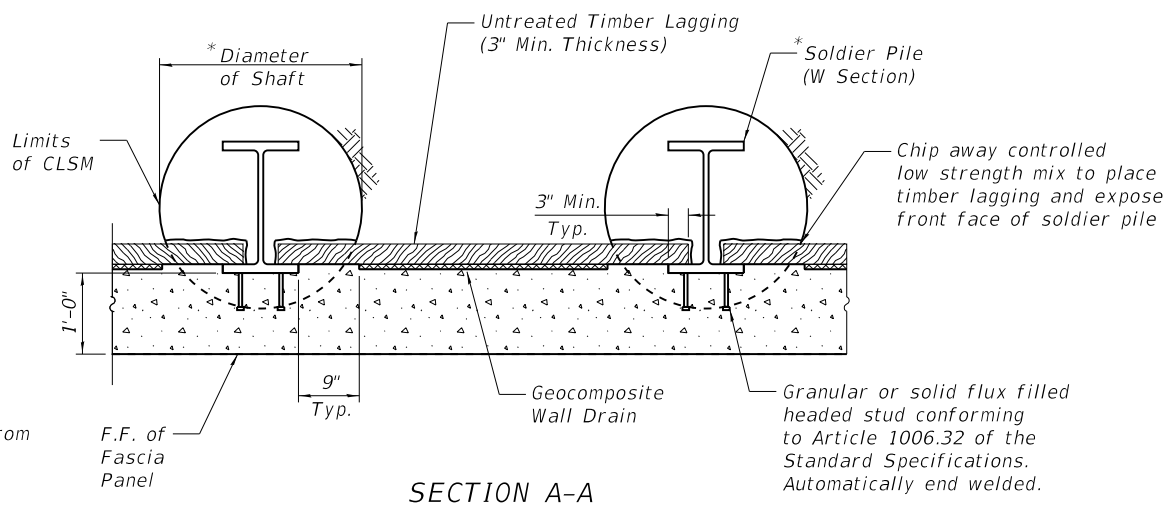
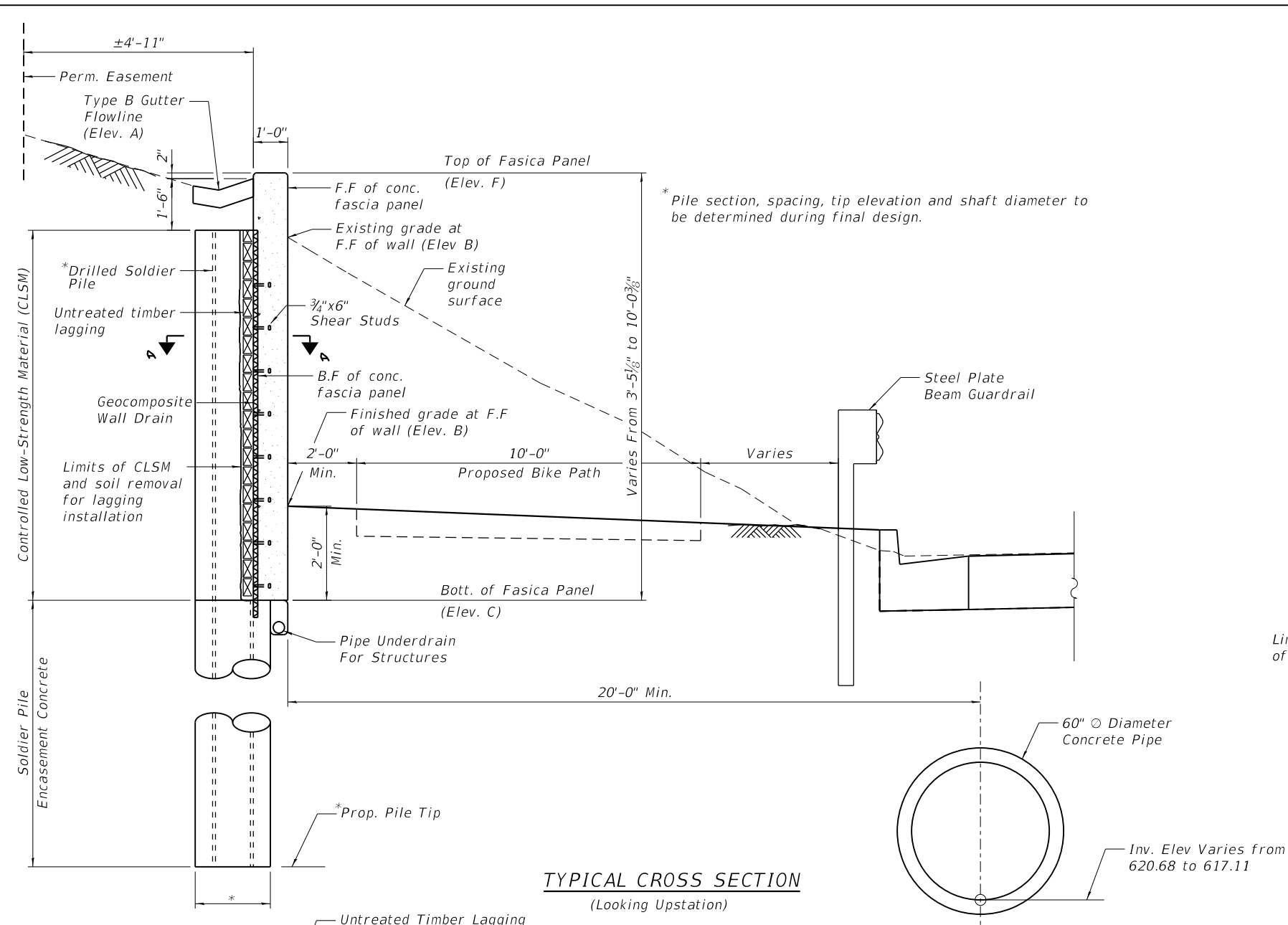

MODEL: \$MODEL\$  
 FILE NAME: \$FILES\$



USER NAME =	DESIGNED -	REVISED -
CHECKED -	REVISED -	REVISED -
DRAWN -	REVISED -	REVISED -
DATE - \$DATE	REVISED -	REVISED -

STATE OF ILLINOIS  
 DEPARTMENT OF TRANSPORTATION

SOLDIER PILE WALL DETAILS  
 STRUCTURE NO. 016-9201

SHEET 2 OF #1TOT SHEETS

F.A.U. RTE.	SECTION	COUNTY	TOTAL SHEETS	SHEET NO.
3512	2018-109-RS, SW&T	COOK	\$TOTAL	
CONTRACT NO. 62H38				
ILLINOIS FED. AID PROJECT				