

F.A.I. RTE.	SECTION	COUNTY	TOTAL SHEETS	SHEET NO.
74	(90-15)RS-3	TAZEWELL	60	50
ILLINOIS		FED. AID PROJECT		

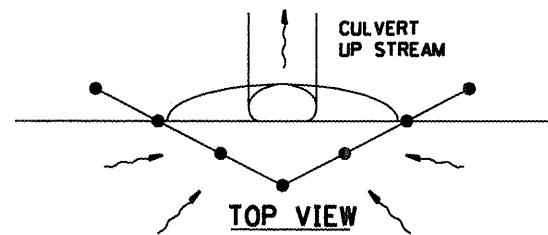

UPSTREAM PIPE CULVERT EROSION CONTROL

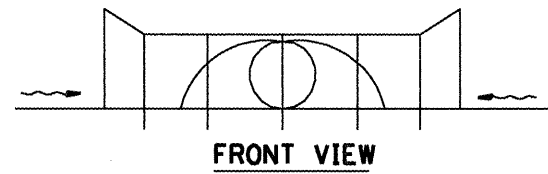
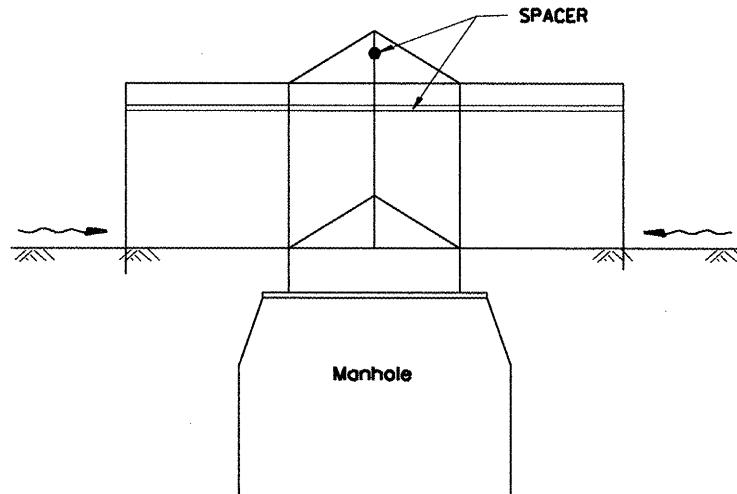

Manhole

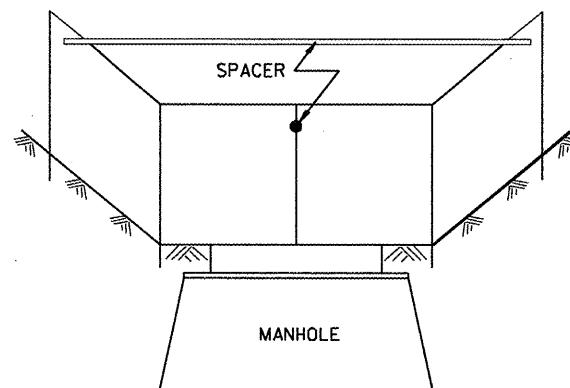
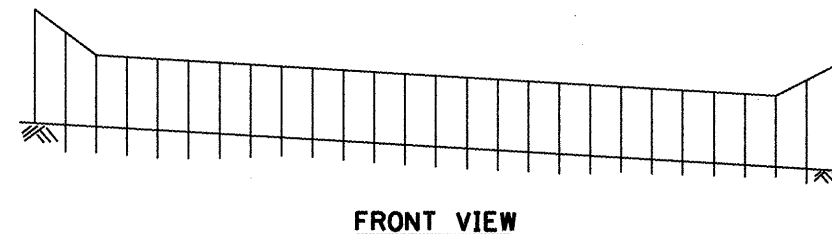
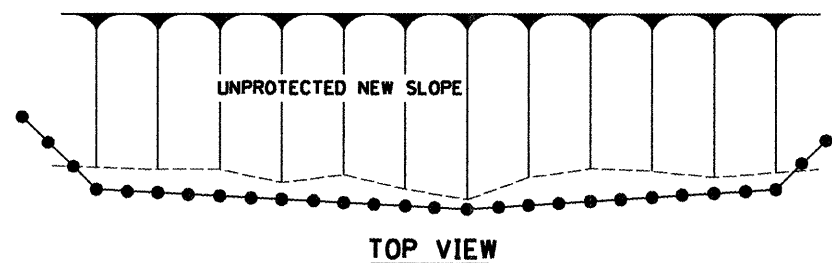
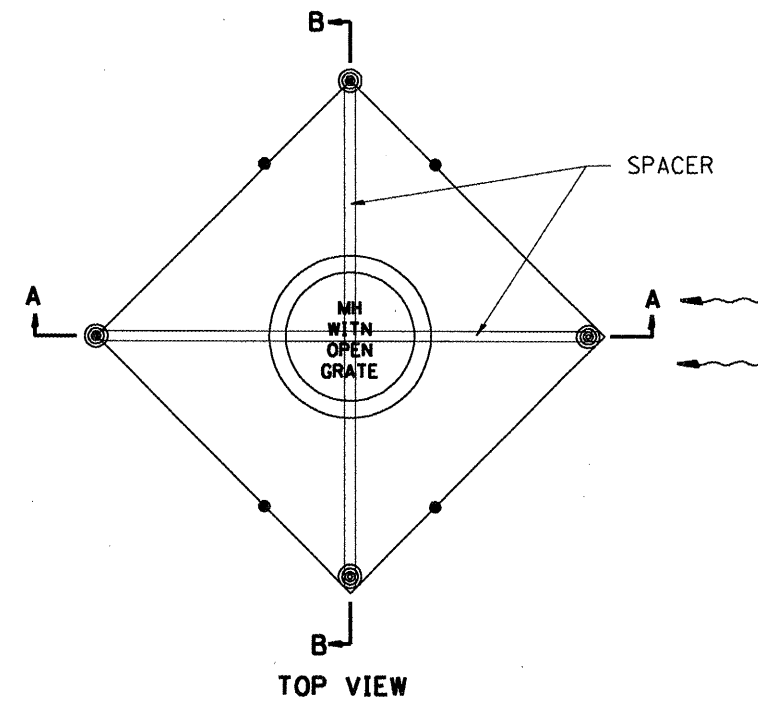

EROSION CONTROL AT OPEN GRATE MAN HOLE

GENERAL NOTES:

1. This work shall be performed in accordance with Sections 280 & 1081, of the Standard Specifications.
2. Additional Timber or Metal Post shall be installed, as needed.

All dimensions are in millimeters (inches) unless otherwise noted.

ILLINOIS DEPARTMENT OF TRANSPORTATION	
SPECIAL DETAIL SHEET	
TYPICAL APPLICATION OF SILT FILTER FENCE	
CADD DETAIL 280001-D4	DRAWN BY CADD
SCALE: NOT DRAWN TO SCALE	CHECKED BY

DATE	REVISIONS	BY
1-1-97	RENUM. A-12.05, NEW REVISION BOX	T.P.
3-11-03	ELIMINATED SILT FENCE DITCH CHECK	M.M.A.

280001-D4

USER NAME = k1manikk	DESIGNED -	REVISED -
PLOT SCALE = 100.0000' / IN.	DRAWN -	REVISED -
PLOT DATE = 2/11/2009	CHECKED -	REVISED -
	DATE -	REVISED -

F.A.I. RTE.	SECTION	COUNTY	TOTAL SHEETS	SHEET NO.
74	(90-15)RS-3	TAZEWELL	60	50
ILLINOIS		FED. AID PROJECT		