

See G.N.

All dimensions are in millimeters (inches) unless otherwise shown.

Illinois Department of Transportation
 APPROVED January 1, 2005
Charles J. Ross
 ENGINEER OF LOCAL ROADS AND STREETS
 APPROVED January 1, 2005
Michael S. Hine
 ENGINEER OF DESIGN AND ENVIRONMENT
 ISSUED 1-1-97

+ = See typical cross section on plans for thickness

DATE	REVISIONS
1-1-05	Revised TYPE D and TYPE E joints.
1-1-97	Renum. Standard B.L.R. 10-2.

PCC PAVEMENT SPECIAL
 (NONREINFORCED)
 (Sheet 1 of 2)
STANDARD B.L.R. 10-4

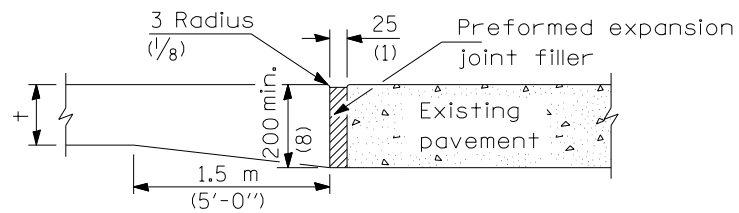

**TYPE A
EXPANSION JOINT**

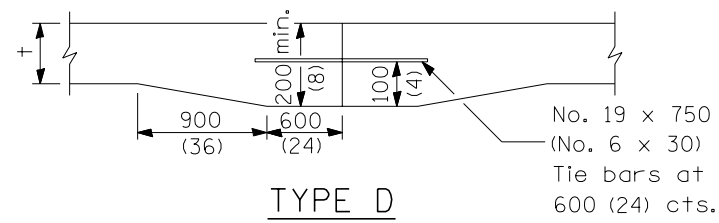

**TYPE D
TIED TRANSVERSE CONSTRUCTION JOINT**

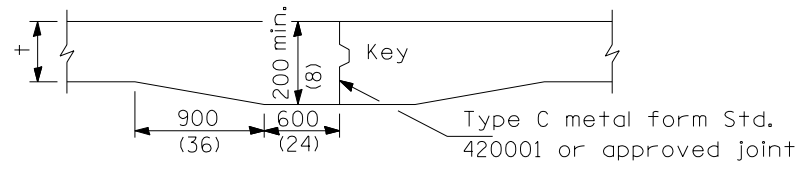

**TYPE B
KEYED JOINT**

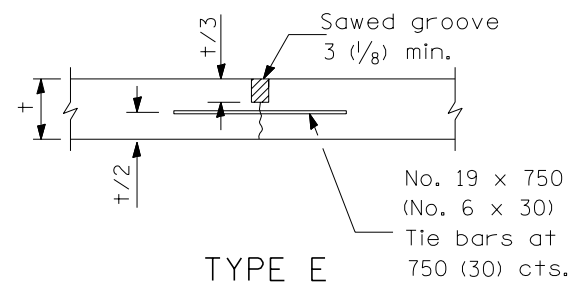

**TYPE E
SAWED LONGITUDINAL JOINT**

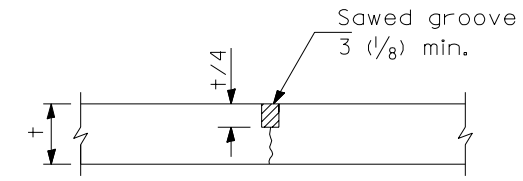

**TYPE C
SAWED TRANSVERSE JOINT**

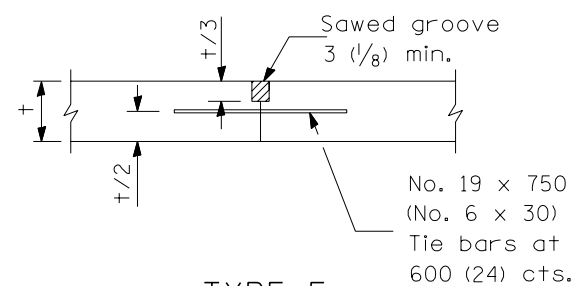

**TYPE E
LONGITUDINAL CONSTRUCTION JOINT**

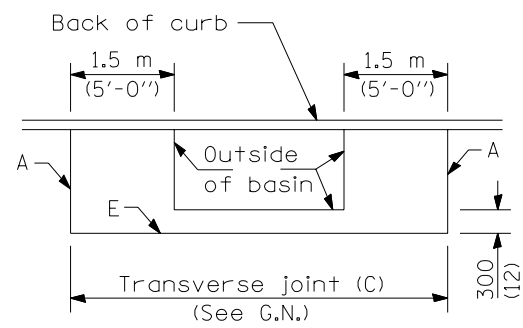

CATCH BASIN DETAIL

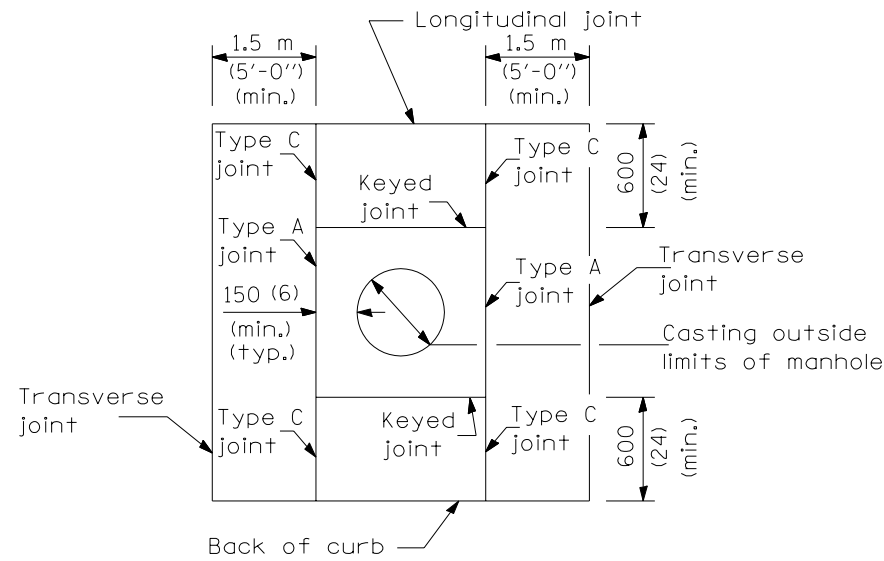

**MANHOLE DETAIL
Showing Joint types**

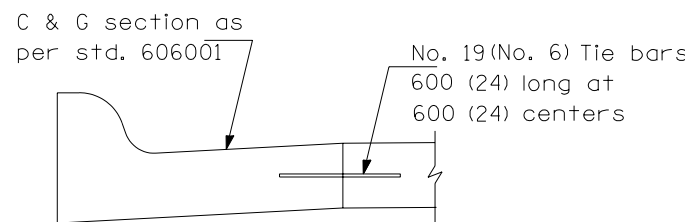

COMB. CURB & GUTTER DETAIL

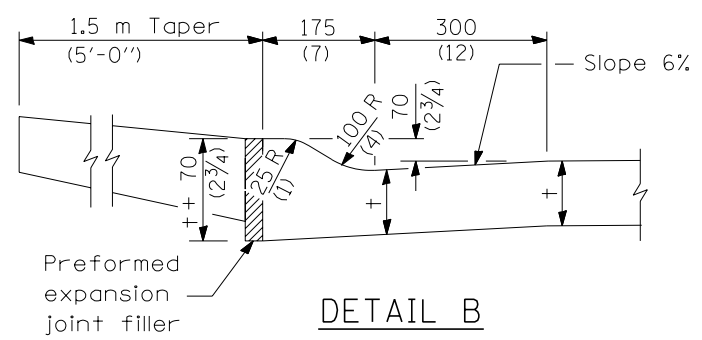

DETAIL B

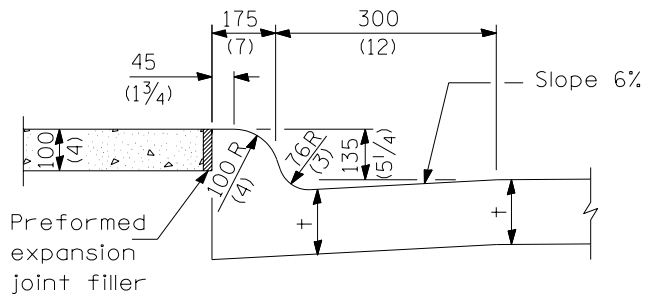

DETAIL A

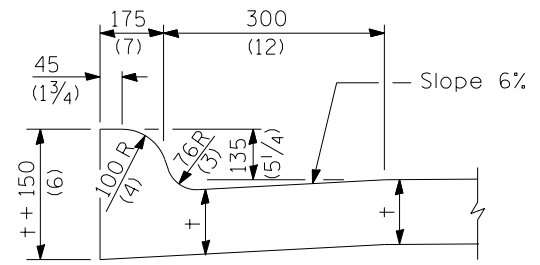

INTEGRAL CURB

See DETAIL A for crosswalks and DETAIL B for driveways.

GENERAL NOTES

All catch basins shall be separated from the pavement and curb by boxing out as shown in the detail. Manhole castings within the pavement limits shall be boxed in a like manner except when telescoping type castings are used.

When a joint falls within 1.5 m (5 feet) of or contacts basins, manholes, or other structures, shorten one or more panels either side of opening to permit joint to fall at the corners of the box out.

When specified, roundouts as shown on Standard 420111 shall be used in lieu of the manhole detail shown herein.

All transverse joints must extend through curbs and be continuous across pavement, except tied transverse construction joints. Expansion joints will be required as shown on the plans.

When specified, the pavement structure thickness at intersections shall be increased. This requirement generally will occur when the design traffic through the intersection exceeds the typical design of the pavement structure either side of the intersection.

Joints shall be sawed to a depth of t/4 for transverse joints and t/3 for longitudinal joints. Saw joints shall be sealed with material meeting the requirements of Section 1050 of the Standard Specifications.

This alternate construction is at the Contractor's option and shall be constructed in accordance with Section 606 of the Standard Specifications. The combination concrete curb and gutter shall be measured in place and the area computed in sq. meters (sq. yards). This work will be paid for at the contract unit price per sq. meters (sq. yards) for portland cement concrete pavement special with integral curb of the thickness specified and shall include all materials and labor.

Transverse joint spacing shall not exceed 4.6 m (15 feet).

Construct TYPE D tied transverse construction joint when construction joint does not fall at a TYPE C sawed transverse joint.

All dimensions are in millimeters (inches) unless otherwise shown.

Illinois Department of Transportation

APPROVED January 1, 2005
Charles J. Ross
ENGINEER OF LOCAL ROADS AND STREETS

APPROVED January 1, 2005
Michael S. Hine
ENGINEER OF DESIGN AND ENVIRONMENT

ISSUED 1-1-97

**PCC PAVEMENT
SPECIAL**
(NONREINFORCED) (Sheet 2 of 2)

STANDARD B.L.R. 10-4