

PANEL SIGN DESIGN TYPE 1

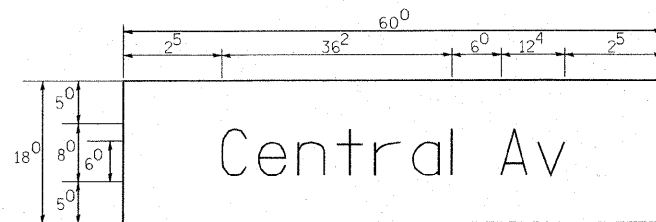

— Sq. M. each
 7.5 Sq. Ft. each
 — 4 Required
 Design Series D

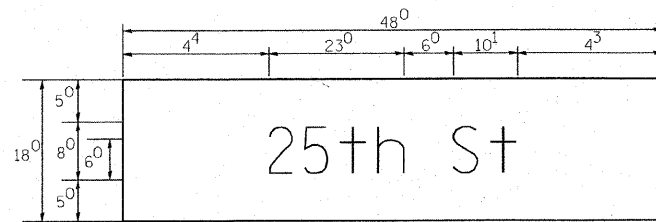

— Sq. M. each
 6.0 Sq. Ft. each
 — 2 Required
 Design Series D

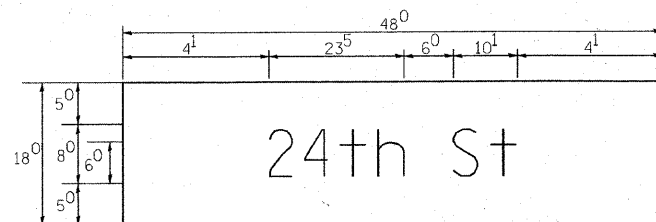

— Sq. M. each
 6.0 Sq. Ft. each
 — 2 Required
 Design Series D

NOTE: SIGN DIMENSIONS ARE IN ENGLISH UNITS

GENERAL NOTES

- WHERE MAST ARM MOUNTED STREET NAME SIGNS ARE SPECIFIED, THE MAST ARM ASSEMBLY AND POLES SHALL BE DESIGNED TO SUPPORT THE LOADINGS CALLED FOR ON STANDARDS 834001, 834006 AND 834011, AS APPLICABLE, PLUS TWO (2) SIGN PANELS 2'-6" x 6'-0" MOUNTED AS SHOWN. THE DESIGN SHALL BE IN ACCORDANCE WITH THE REQUIREMENTS OF THE CURRENT "STANDARD SPECIFICATIONS FOR STRUCTURAL SUPPORTS FOR HIGHWAY SIGNS, LUMINAIRES, AND TRAFFIC SIGNALS" AS PUBLISHED BY THE AMERICAN ASSOCIATION OF STATE HIGHWAY AND TRANSPORTATION OFFICIALS FOR 80 M.P.H. WIND VELOCITY.
- ALL SIGNS SHALL HAVE A WHITE REFLECTORIZED LEGEND AND BORDER ON A GREEN REFLECTORIZED BACKGROUND, TYPE A SHEETING.
- THE SIGN LENGTH SHOULD BE INCREASED IN 6-INCH INCREMENTS, BUT THE OVERALL LENGTH SHOULD NOT EXCEED 6'-0".
- ALL BORDERS SHALL BE 3/4" WIDE AND CORNER RADIUS SHALL BE 2-1/4".
- SIGNFIX ALUMINUM CHANNEL FRAMING SYSTEM SHALL BE USED FOR ALL SIGNS ATTACHED TO SIGNAL POLES AND POSTS. LOCAL SUPPLIERS OF THE SIGNFIX ALUMINUM CHANNEL FRAMING SYSTEM ARE:
 - * A.K.T. CORPORATION
 - * TUCKER COMPANY, INC.
 - * WAUWATOSA, WI
 - * AMERICAN FABRICATION CO.
 - * CHICAGO HEIGHTS, IL
 - * WESTERN TRAFFIC CONTROL, INC.
 - * CICERO, IL

PARTS LISTING:

SIGN CHANNEL
 SIGN SCREWS
 BRACKETS

PART #HPN053 (MED. CHANNEL)
 1/4" x 14 x 1" H.W.H. #3
 SELF TAPPING WITH NEOPRENE WASHER
 PART #HPN034 (UNIVERSAL)
 CHANNEL CLAMPS WITH STAINLESS STEEL STRAPPING

OTHER BRANDS OF MOUNTING HARDWARE ARE ACCEPTABLE, BASED UPON THE DEPARTMENT'S APPROVAL AND COMPATIBILITY WITH THE CHANNEL/BACKET OF THE ABOVE PRODUCT.

SUPPORTING CHANNELS

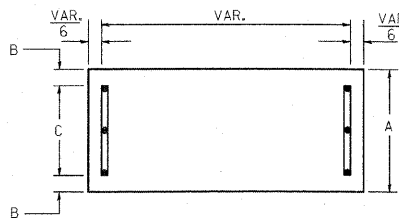

A	B	C
18"	2"	14"

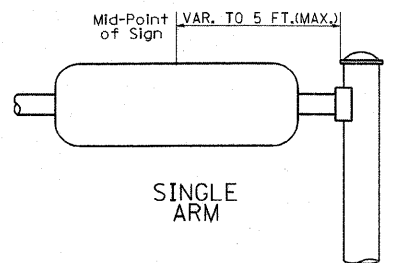

SUPPORTING CHANNELS

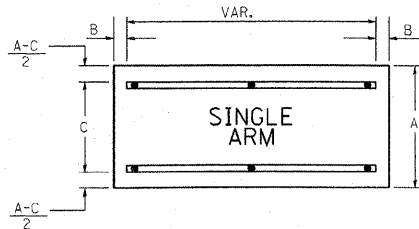

A	B	C
18"	2"	12"
30"	2"	22"

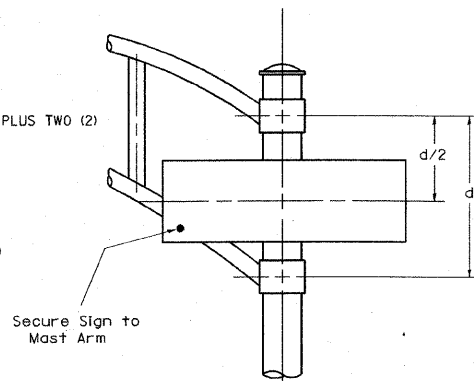

DUAL ARM
 SIGNFIX ALUMINUM CHANNEL FRAMING SYSTEM
 Shall be used. See Note #5.

Upper Case To Lower Case
 Spacing Chart 8-6 Inch Series "C & D"

FIRST LETTER	SECOND LETTER															
	acde		bhikl		f w		j		s t		v y		x		z	
	C	D	C	D	C	D	C	D	C	D	C	D	C	D	C	D
A W X	12	14	14	15	12	14	06	10	11	14	06	10	11	12	12	14
B	14	15	20	21	14	15	11	12	14	15	12	14	12	14	16	17
C E G	14	15	20	21	12	14	06	10	12	14	12	14	14	15	14	15
D O O R	14	15	20	21	14	15	06	10	12	14	12	14	14	15	14	15
F	05	06	14	15	06	10	05	06	06	10	06	10	06	10	11	12
H I M N	20	21	22	24	20	21	14	15	16	17	16	17	20	21	20	21
J U	20	21	20	21	16	17	14	15	16	17	16	17	16	17	20	21
K L	11	12	16	17	11	12	05	06	11	12	11	12	11	12	12	14
P	12	14	14	15	12	14	05	06	11	12	11	12	12	14	12	14
S	12	14	16	17	12	14	06	10	12	14	12	14	12	14	12	14
T	11	12	16	17	06	10	06	10	11	12	11	12	11	12	12	14
V	06	10	14	15	11	12	06	10	12	14	12	14	12	14	12	14
Y	05	06	14	15	06	10	05	06	05	07	05	06	06	10	11	12
Z	16	17	22	24	16	17	12	14	16	17	16	17	16	17	20	21

Lower Case To Lower Case
 Spacing Chart 6 Inch Series "C & D"

FIRST LETTER	SECOND LETTER															
	acde		bhikl		f w		j		s t		v y		x		z	
	C	D	C	D	C	D	C	D	C	D	C	D	C	D	C	D
adhgij	16	17	22	24	16	17	12	14	14	15	14	15	16	17	16	17
lmnqu																
bfkops	12	14	16	17	11	12	05	06	11	12	11	12	12	14	12	14
c e	12	14	16	17	12	14	06	10	12	14	12	14	12	14	12	14
r	06	10	12	14	06	10	03	03	05	06	05	06	06	10	06	10
t z	12	14	16	17	12	14	06	10	11	12	11	12	12	14	12	14
v y	11	12	14	15	11	12	05	06	06	10	06	10	11	12	11	12
w	11	12	14	15	11	12	05	06	11	12	11	12	11	12	12	14
x	12	14	16	17	11	12	05	06	11	12	11	12	11	12	12	14

Number To Number
 Spacing Chart 8 Inch Series "C & D"

FIRST NUMBER	SECOND NUMBER																			
	0		1		2		3		4		5		6		7		8		9	
	C	D	C	D	C	D	C	D	C	D	C	D	C	D	C	D	C	D	C	D
0 9	16	17	16	17	14	15	12	14	14	15	14	15	16	17	12	14	16	17	16	17
1	20	21	20	21	20	21	16	17	14	15	20	21	20	21	14	15	20	21	20	21
2 3 4	14	15	14	15	14	15	12	14	12	14	14	15	14	15	11	12	16	17	14	15
5	14	15	14	15	14	15	11	12	11	12	14	15	14	15	11	12	14	15	14	15
6	16	17	14	15	14	15	12	15	12	14	14	15	14	15	11	12	14	15	14	15
7	12	14	12	14	14	15	12	15	05	06	12	14	14	15	11	12	14	15	12	14
8	16	17	16	17	14	15	12	15	12	14	14	15	16	17	12	14	16	17	14	15

EXAMPLE, 2³ DENOTES 3"/8"

UPPER AND LOWER CASE LETTER WIDTHS

LETTERS	6 INCH UPPER CASE LETTERS				8 INCH UPPER CASE LETTERS				LETTERS	6 INCH LOWER CASE LETTERS	
	SERIES		SERIES		SERIES		SERIES			SERIES	
	C	D	C	D	C	D	C	D		C	D
A	3 ⁶	5 ⁰	5 ⁰	6 ⁵	a	3 ⁵	4 ²				
B	3 ²	4 ⁰	4 ³	5 ³	b	3 ⁵	4 ²				
C	3 ²	4 ⁰	4 ³	5 ³	c	3 ⁵	4 ¹				
D	3 ²	4 ⁰	4 ³	5 ³	d	3 ⁵	4 ²				
E	3 ⁰	3 ⁵	4 ⁰	4 ⁷	e	3 ⁵	4 ²				
F	3 ⁰	3 ⁵	4 ⁰	4 ⁷	f	2 ³	2 ⁶				
G	3 ²	4 ⁰	4 ³	5 ³	g	3 ⁵	4 ²				
H	3 ²	4 ⁰	4 ³	5 ³	h	3 ⁵	4 ²				
I	0 ⁷	0 ⁷	1 ¹	1 ²	i	1 ¹	1 ¹				
J	3 ⁰	3 ⁶	4 ⁰	5 ⁰	j	2 ⁰	2 ²				
K	3 ²	4 ¹	4 ³	5 ⁴	k	3 ⁵	4 ²				
L	3 ⁰	3 ⁵	4 ⁰	4 ⁷	l	1 ¹	1 ¹				
M	3 ⁷	4 ⁵	5 ¹	6 ¹	m	6 ⁰	7 ⁰				
N	3 ²	4 ⁰	4 ³	5 ³	n	3 ⁵	4 ²				
O	3 ⁴	4 ²	4 ⁵	5 ⁵	o	3 ⁶	4 ³				
P	3 ²	4 ⁰	4 ³	5 ³	p	3 ⁵	4 ²				
Q	3 ⁴	4 ²	4 ⁵	5 ⁵	q	3 ⁵	4 ²				
R	3 ²	4 ⁰	4 ³	5 ³	r	2 ⁶	3 ²				
S	3 ²	4 ⁰	4 ³	5 ³	s	3 ⁶	4 ²				
T	3 ⁰	3 ⁵	4 ⁰	4 ⁷	t	2 ⁷	3 ²				
U	3 ²	4 ⁰	4 ³	5 ³	u	3 ⁵	4 ²				
V	3 ⁵	4 ⁴	4 ⁷	6 ⁰	v	4 ²	4 ⁷				
W	4 ⁴	5 ²	6 ⁰	7 ⁰	w	5 ⁵	6 ⁴				
X	3 ⁴	4 ⁰	4 ⁵	5 ³	x	4 ⁴	5 ¹				
Y	3 ⁶	5 ⁰	5 ⁰	6 ⁶	y	4 ⁶	5 ³				
Z	3 ²	4 ⁰	4 ³	5 ³	z	3 ⁶	4 ³				

NUMBER	6 INCH SERIES		8 INCH SERIES	
	C	D	C	D
1	1 ²	1 ⁴	1 ⁵	2 ⁰
2	3 ²	4 ⁰	4 ³	5 ³
3	3 ²	4 ⁰	4 ³	5 ³
4	3 ⁵	4 ³	4 ⁷	5 ⁷
5	3 ²	4 ⁰	4 ³	5 ³
6	3 ²	4 ⁰	4 ³	5 ³
7	3 ²	4 ⁰	4 ³	5 ³
8	3 ²	4 ⁰	4 ³	5 ³
9	3 ²	4 ⁰	4 ³	5 ³
0	3 ⁴	4 ²	4 ⁵	5 ⁵

FILE NAME = ...:\signal\17-stname.dgn	USER NAME = DESIGNED - JHE DRAWN - RDB PLOT SCALE = PLOT DATE = 1/28/2010	DESIGNED - JHE DRAWN - RDB CHECKED - DAD DATE -	REVISED - D.A.Z./D.A.G. 11/90 REVISED - D.A.Z./D.A.G. 6/98 REVISED - CAAD 10/00 REVISED -
--	---	--	--

STATE OF ILLINOIS
 DEPARTMENT OF TRANSPORTATION

MAST ARM MOUNTED
 STREET NAME SIGNS

SCALE: NONE SHEET NO. OF SHEETS STA. TO STA.

COUNTY COOK 03-00193-00-PP	TOTAL SHEETS 51	SHEET NO. 42
----------------------------------	--------------------	-----------------

CONTRACT NO. 03445