

EXAMPLE, 2 <sup>3</sup> DENOTES 3/8"

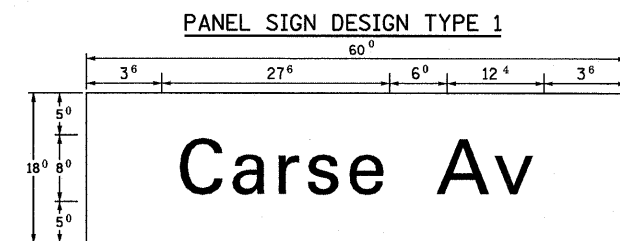

0.70 Sq. M. each  
7.50 Sq. Ft. each  
2 Required  
Design Series D

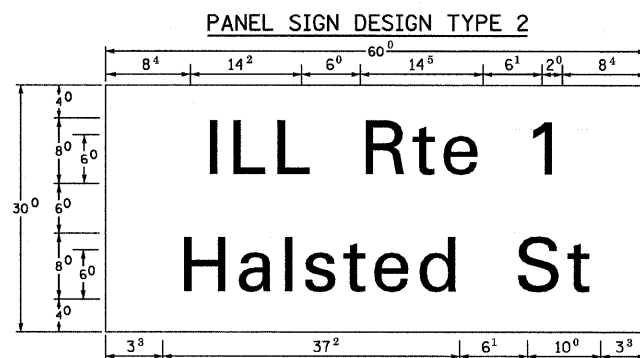
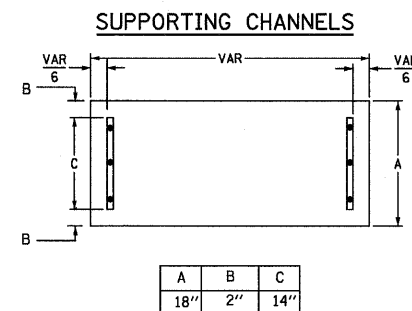

1.16 Sq. M. each  
12.50 Sq. Ft. each  
2 Required  
Design Series D

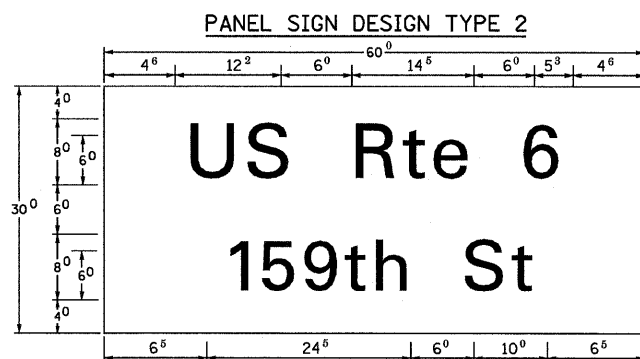
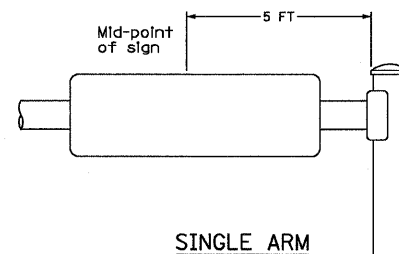

1.05 Sq. M. each  
11.25 Sq. Ft. each  
10 Required  
Design Series D

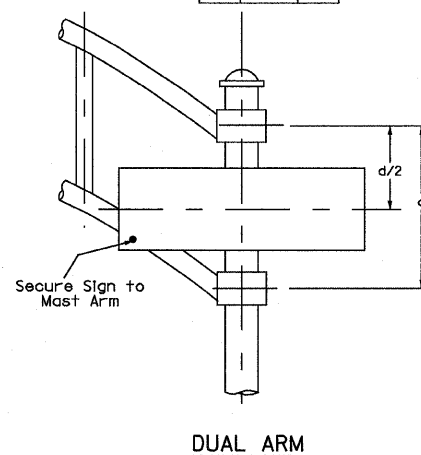
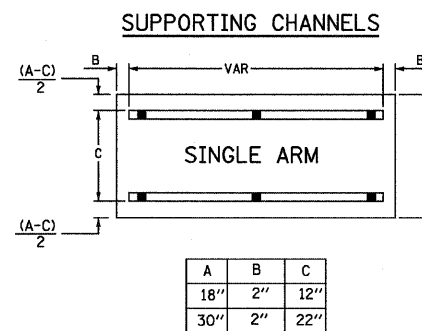

**GENERAL NOTES**

- WHERE MAST ARM MOUNTED STREET NAME SIGNS ARE SPECIFIED, THE MAST ARM ASSEMBLY AND POLES SHALL BE DESIGNED TO SUPPORT THE LOADINGS CALLED FOR AN STANDARDS 834001, 834006 AND 834011, AS APPLICABLE, PLUS A 2'-6" BY 6'-0" SIGN PANEL MOUNTED AS SHOWN. THE DESIGN SHALL BE IN ACCORDANCE WITH THE REQUIREMENTS OF THE CURRENT "STANDARD SPECIFICATIONS FOR STRUCTURAL SUPPORTS FOR HIGHWAY SIGNS, LUMINAIRES AND TRAFFIC SIGNALS" AS PUBLISHED BY THE AMERICAN ASSOCIATION OF STATE HIGHWAY AND TRANSPORTATION OFFICIALS FOR 80 M.P.H. WIND VELOCITY.
- ALL SIGNS SHALL HAVE A WHITE REFLECTORIZED LEGEND AND BORDER ON A GREEN REFLECTORIZED BACKGROUND. TYPE A SHEETING.
- THE SIGN LENGTH SHOULD BE INCREASED IN 6-INCH INCREMENTS, BUT THE OVERALL LENGTH SHOULD NOT EXCEED 6'-0".
- ALL BORDERS SHALL BE 3/4" WIDE AND CORNER RADIUS SHALL BE 2 1/2".
- SIGNFIX ALUMINUM CHANNEL FRAMING SYSTEM SHALL BE FOR ALL SIGNS ATTACHED TO SIGNAL POLES AND POSTS. LOCAL SUPPLIERS OF SIGNFIX ALUMINUM CHANNEL FRAMING SYSTEM ARE:

A.K.T. CORPORATION SCHAUMBURG, IL. TUCKER COMPANY, INC. WAUWATOSA, WI.	AMERICAN FABRICATION CO. CHICAGO HEIGHTS, IL. WESTERN TRAFFIC CONTROL INC. CICERO, IL.
<b>PARTS LISTING</b>	
SIGN CHANNEL	PART # HPN053 (MED. CHANNEL)
SIGN SCREWS	1/4" X 14 X 1" H.W.H. #3 SELF TAPPING WITH NEOPREAN WASHER
BRACKETS	PART # HPN034 (UNIVERSAL) CHANNEL CLAMPS WITH STAINLESS STEEL STRAPPING

OTHER BRANDS OF MOUNTING HARDWARE ARE ACCEPTABLE, BASED UPON THE DEPARTMENT'S APPROVAL AND COMPATIBILITY WITH THE CHANNEL/BACKET OF THE ABOVE PRODUCT.

**SIGNFIX ALUMINUM CHANNEL FRAMING SYSTEM** shall be used. See Note #5.

**Upper Case To Lower Case Spacing Chart 8-6 Inch Series "C & D"**

FIRST LETTER	SECOND LETTER																
	a o e e		b h k l		f w		J		s t		v y		x		z		
	C	D	C	D	C	D	C	D	C	D	C	D	C	D	C	D	
A W X	1 2	1 4	1 4	1 5	1 2	1 4	0 6	1 0	1 1	1 4	0 6	1 0	1 1	1 2	1 2	1 4	
B	1 4	1 5	2 0	2 1	1 4	1 5	1 1	1 2	1 4	1 5	1 2	1 4	1 2	1 4	1 6	1 7	
C E G	1 4	1 5	2 0	2 1	1 2	1 4	0 6	1 0	1 2	1 4	1 2	1 4	1 4	1 5	1 4	1 5	
D O Q R	1 4	1 5	2 0	2 1	1 4	1 5	0 6	1 0	1 2	1 4	1 2	1 4	1 4	1 5	1 4	1 5	
F	0 5	0 6	1 4	1 5	0 6	1 0	0 5	0 6	1 0	0 6	1 0	0 6	1 0	0 6	1 0	1 1	1 2
H I M N	2 0	2 1	2 2	2 4	2 0	2 1	1 4	1 5	1 6	1 7	1 6	1 7	2 0	2 1	2 0	2 1	
J U	2 0	2 1	2 0	2 1	1 6	1 7	1 4	1 5	1 6	1 7	1 6	1 7	1 6	1 7	2 0	2 1	
K L	1 1	1 2	1 6	1 7	1 1	1 2	0 5	0 6	1 1	1 2	1 1	1 2	1 1	1 2	1 2	1 4	
P	1 2	1 4	1 4	1 5	1 2	1 4	0 5	0 6	1 1	1 2	1 1	1 2	1 2	1 4	1 2	1 4	
S	1 2	1 4	1 6	1 7	1 2	1 4	0 5	0 6	1 1	1 2	1 1	1 2	1 1	1 2	1 2	1 4	
T	1 1	1 2	1 6	1 7	0 6	1 0	0 6	1 0	1 1	1 2	1 1	1 2	1 1	1 2	1 2	1 4	
V	0 6	1 0	1 4	1 5	1 1	1 2	0 6	1 0	1 2	1 4	1 2	1 4	1 2	1 4	1 2	1 4	
Y	0 5	0 6	1 4	1 5	0 6	1 0	0 5	0 6	0 5	0 7	0 5	0 6	0 6	1 0	1 1	1 2	
Z	1 6	1 7	2 2	2 4	1 6	1 7	1 2	1 4	1 6	1 7	1 6	1 7	1 6	1 7	2 0	2 1	

**Lower Case To Lower Case Spacing Chart 6 Inch Series "C & D"**

FIRST LETTER	SECOND LETTER															
	a o e e		b h k l		f w		J		s t		v y		x		z	
	C	D	C	D	C	D	C	D	C	D	C	D	C	D	C	D
adhglj lmnqu	1 6	1 7	2 2	2 4	1 6	1 7	1 2	1 4	1 4	1 5	1 4	1 5	1 6	1 7	1 6	1 7
bfkops	1 2	1 4	1 6	1 7	1 1	1 2	0 5	0 6	1 1	1 2	1 1	1 2	1 2	1 4	1 2	1 4
ce	1 2	1 4	1 6	1 7	1 2	1 4	0 6	1 0	1 2	1 4	1 2	1 4	1 2	1 4	1 2	1 4
r	0 6	1 0	1 2	1 4	0 6	1 0	0 3	0 3	0 5	0 6	0 5	0 6	0 6	1 0	0 6	1 0
tz	1 2	1 4	1 6	1 7	1 2	1 4	0 6	1 0	1 1	1 2	1 1	1 2	1 2	1 4	1 2	1 4
vy	1 1	1 2	1 4	1 5	1 1	1 2	0 5	0 6	0 6	1 0	0 6	1 0	1 1	1 2	1 1	1 2
w	1 1	1 2	1 4	1 5	1 1	1 2	0 5	0 6	1 1	1 2	1 1	1 2	1 1	1 2	1 2	1 4
x	1 2	1 4	1 6	1 7	1 1	1 2	0 5	0 6	1 1	1 2	1 1	1 2	1 1	1 2	1 2	1 4

**Number to Number Spacing Chart 8 Inch Series "C & D"**

FIRST NUMBER	SECOND NUMBER																			
	0		1		2		3		4		5		6		7		8		9	
	C	D	C	D	C	D	C	D	C	D	C	D	C	D	C	D	C	D	C	D
0 9	1 6	1 7	1 6	1 7	1 4	1 5	1 2	1 4	1 4	1 5	1 4	1 5	1 6	1 7	1 2	1 4	1 6	1 7	1 6	1 7
1	2 0	2 1	2 0	2 1	2 0	2 1	1 6	1 7	1 4	1 5	2 0	2 1	2 0	2 1	1 4	1 5	2 0	2 1	2 0	2 1
2 3 4	1 4	1 5	1 4	1 5	1 4	1 5	1 2	1 4	1 2	1 4	1 5	1 4	1 5	1 1	1 2	1 6	1 7	1 4	1 5	1 4
5	1 4	1 5	1 4	1 5	1 4	1 5	1 1	1 2	1 1	1 2	1 4	1 5	1 4	1 5	1 1	1 2	1 4	1 5	1 4	1 5
6	1 6	1 7	1 4	1 5	1 4	1 5	1 2	1 5	1 2	1 4	1 4	1 5	1 4	1 5	1 1	1 2	1 4	1 5	1 4	1 5
7	1 2	1 4	1 2	1 4	1 4	1 5	1 2	1 5	0 5	0 6	1 2	1 4	1 5	1 1	1 2	1 4	1 5	1 2	1 4	1 4
8	1 6	1 7	1 6	1 7	1 4	1 5	1 2	1 5	1 2	1 4	1 4	1 5	1 6	1 7	1 2	1 4	1 6	1 7	1 4	1 5

**UPPER AND LOWER CASE LETTER WIDTHS**

LETTERS	6 INCH UPPER CASE LETTERS				8 INCH UPPER CASE LETTERS				6 INCH LOWER CASE LETTERS			
	SERIES		SERIES		SERIES		SERIES		SERIES		SERIES	
	C	D	C	D	C	D	C	D	C	D	C	D
A	3 6	5 0	5 0	6 5	a	3 5	4 2					
B	3 2	4 0	4 3	5 3	b	3 5	4 2					
C	3 2	4 0	4 3	5 3	c	3 5	4 1					
D	3 2	4 0	4 3	5 3	d	3 5	4 2					
E	3 0	3 5	4 0	4 7	e	3 5	4 2					
F	3 0	3 5	4 0	4 7	f	2 3	2 6					
G	3 2	4 0	4 3	5 3	g	3 5	4 2					
H	3 2	4 0	4 3	5 3	h	3 5	4 2					
I	0 7	0 7	1 1	1 2	i	1 1	1 1					
J	3 0	3 6	4 0	5 0	j	2 0	2 2					
K	3 2	4 1	4 3	5 4	k	3 5	4 2					
L	3 0	3 5	4 0	4 7	l	1 1	1 1					
M	3 7	4 5	5 1	6 1	m	6 0	7 0					
N	3 2	4 0	4 3	5 3	n	3 5	4 2					
O	3 4	4 2	4 5	5 5	o	3 6	4 3					
P	3 2	4 0	4 3	5 3	p	3 5	4 2					
Q	3 4	4 2	4 5	5 5	q	3 5	4 2					
R	3 2	4 0	4 3	5 3	r	2 6	3 2					
S	3 2	4 0	4 3	5 3	s	3 6	4 2					
T	3 0	3 5	4 0	4 7	t	2 7	3 2					
U	3 2	4 0	4 3	5 3	u	3 5	4 2					
V	3 5	4 4	4 7	6 0	v	4 2	4 7					
W	4 4	5 2	6 0	7 0	w	5 5	6 4					
X	3 4	4 0	4 5	5 3	x	4 4	5 1					
Y	3 6	5 0	5 0	6 6	y	4 6	5 3					
Z	3 2	4 0	4 3	5 3	z	3 6	4 3					

NUMBER	6 INCH SERIES		8 INCH SERIES	
	C	D	C	D
1	1 2	1 4	1 5	2 0
2	3 2	4 0	4 3	5 3
3	3 2	4 0	4 3	5 3
4	3 5	4 3	4 7	5 7
5	3 2	4 0	4 3	5 3
6	3 2	4 0	4 3	5 3
7	3 2	4 0	4 3	5 3
8	3 2	4 0	4 3	5 3
9	3 2	4 0	4 3	5 3
0	3 4	4 2	4 5	5 5

REVISIONS	
NAME	DATE

ILLINOIS DEPARTMENT OF TRANSPORTATION  
US RTE 6 FROM I-294 TO IL RTE 1  
MAST ARM MOUNTED STREET NAME SIGNS

SCALE: N.T.S. DRAWN BY: DK  
DATE: 01/28/09 CHECKED BY: JA