

EXISTING TYPICAL SECTION
 STA. 36+64.41 TO STA. 37+86.50 (BRIDGE)
 STA. 37+86.50 TO STA. 47+88

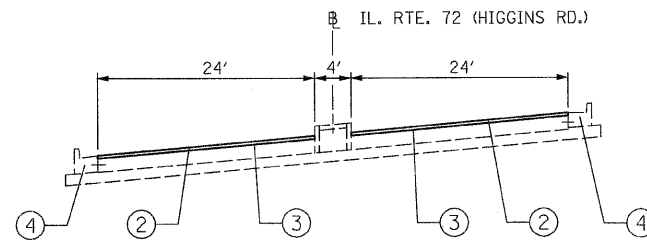

PROPOSED TYPICAL SECTION
 STA. 36+64.41 TO STA. 37+86.50 (BRIDGE)
 STA. 37+86.50 TO STA. 47+88

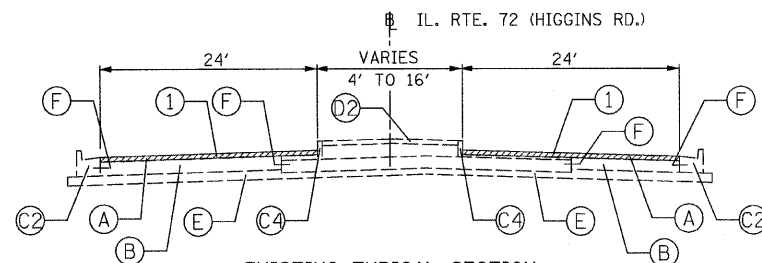

EXISTING TYPICAL SECTION
 STA. 47+88 TO STA. 51+20

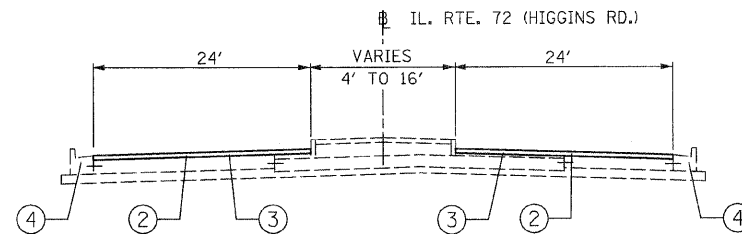

PROPOSED TYPICAL SECTION
 STA. 47+88 TO STA. 51+20

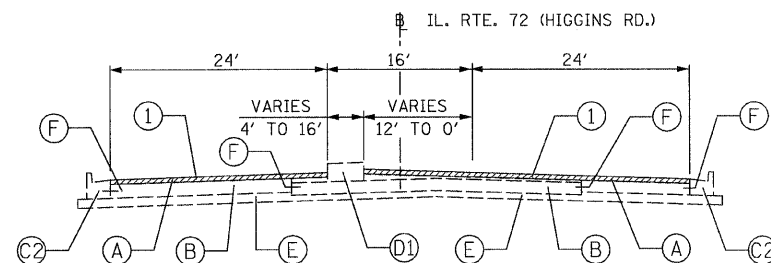

EXISTING TYPICAL SECTION
 STA. 51+20 TO STA. 57+02

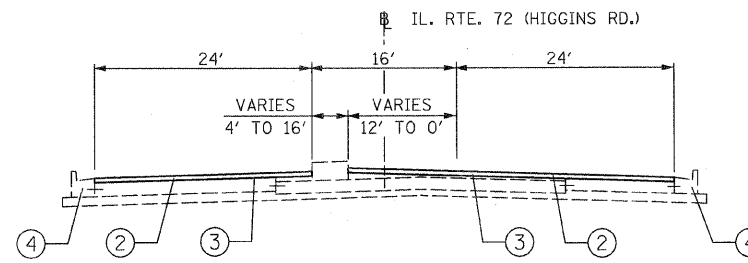

PROPOSED TYPICAL SECTION
 STA. 51+20 TO STA. 57+02

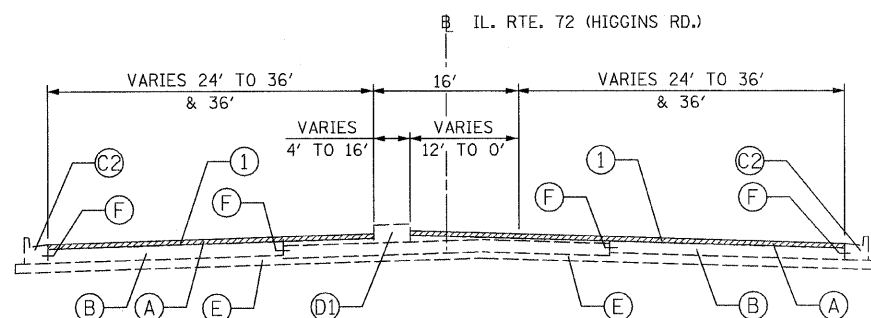

EXISTING TYPICAL SECTION
 STA. 57+02 TO STA. 67+66

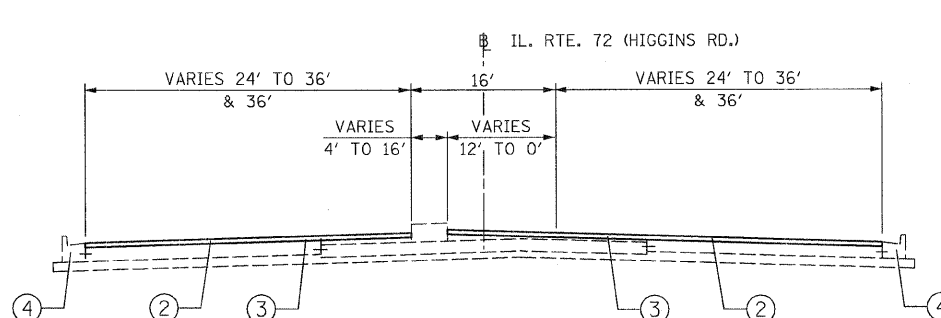

PROPOSED TYPICAL SECTION
 STA. 57+02 TO STA. 67+66

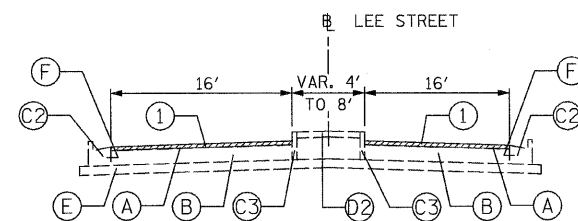

EXISTING TYPICAL SECTION
 STA. 300+32 TO STA. 303+10

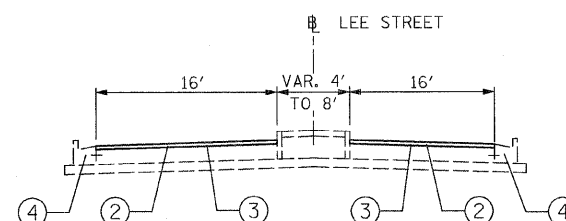

PROPOSED TYPICAL SECTION
 STA. 300+32 TO STA. 303+10

EXISTING CONDITIONS:

- (A) HOT-MIX ASPHALT SURFACE AND BINDER COURSE, 3" & VARIES
- (B) P.C.C. BASE COURSE, 9" OR P.C.C. PAVEMENT, 10"
- (C) COMBINATION CONCRETE CURB AND GUTTER, TYPE B-6.12
- (C1) COMBINATION CONCRETE CURB AND GUTTER, TYPE B-6.18
- (C2) COMBINATION CONCRETE CURB AND GUTTER, TYPE B-6.24
- (C3) CONCRETE CURB, TYPE B-6
- (C4) CONCRETE CURB, TYPE B-6 (DOWELLED)
- (D) CONCRETE MEDIAN, BARRIER OR MOUNTABLE
- (D1) CONCRETE MEDIAN, CORRUGATED OR BARRIER (DOWELLED)
- (D2) CONCRETE MEDIAN SURFACE, 4" & VARIES
- (E) SUB-BASE GRANULAR, TYPE B, 4" OR 6"
- (F) TIE-BARS

PROPOSED IMPROVEMENTS:

- (1) HOT-MIX ASPHALT SURFACE REMOVAL, 2 1/2 "
- (2) POLYMERIZED HOT-MIX ASPHALT SURFACE COURSE, MIX "F", N90, 1 3/4 "
- (3) POLYMERIZED LEVELING BINDER (MACHINE METHOD), IL-4.75, N50, 3/4 "
- (4) COMB. CONC. CURB AND GUTTER REMOVAL AND REPLACEMENT (AS DETERMINED BY THE ENGINEER)

FILE NAME = D168F40-shr-typical.dgn
 PLOT DATE = 3/6/2009

CHRISTIAN-ROGE & ASSOCIATES, INC.
 ENGINEERS-PLANNERS-SURVEYORS
 211 WEST WACKER DRIVE
 CHICAGO, ILLINOIS 60606
 PHONE: (312)372-2023 FAX: (312)372-5274

DESIGNED - G.F.L.
 DRAWN - B.K.
 CHECKED - M.P.
 DATE - MARCH 13, 2009

REVISED -
 REVISED -
 REVISED -
 REVISED -

STATE OF ILLINOIS
DEPARTMENT OF TRANSPORTATION

TYPICAL SECTIONS
IL 72 (TOUHY AVE./HIGGINS RD.)
 SCALE: NONE SHEET NO. 3 OF 3 SHEETS STA. VARIOUS TO STA. VARIOUS

F.A.U. RTE.	SECTION	COUNTY	TOTAL SHEETS	SHEET NO.
1350	2008-063 RS	COOK	42	6
FED. ROAD DIST. NO. 1 ILLINOIS FED. AID PROJECT			CONTRACT NO. 60F40	