

ENTRANCE APPROACHES - URBAN AREA

TYPICAL APPLICATION OF ENTRANCES

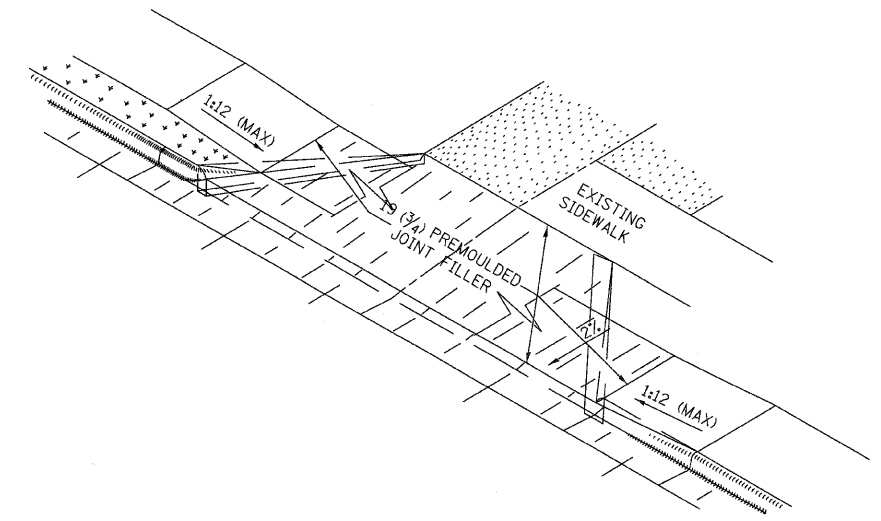
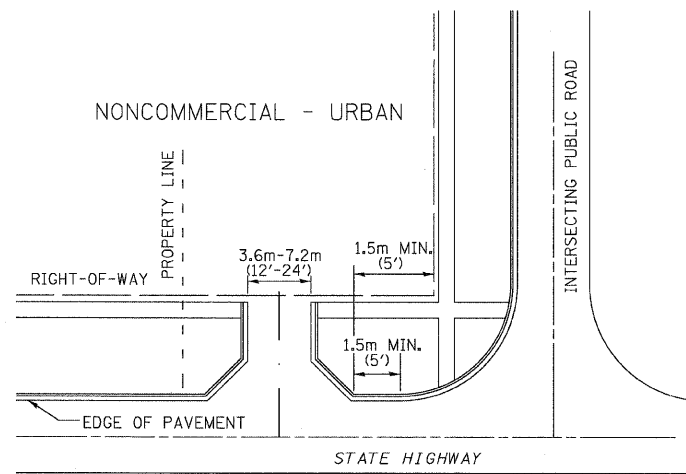
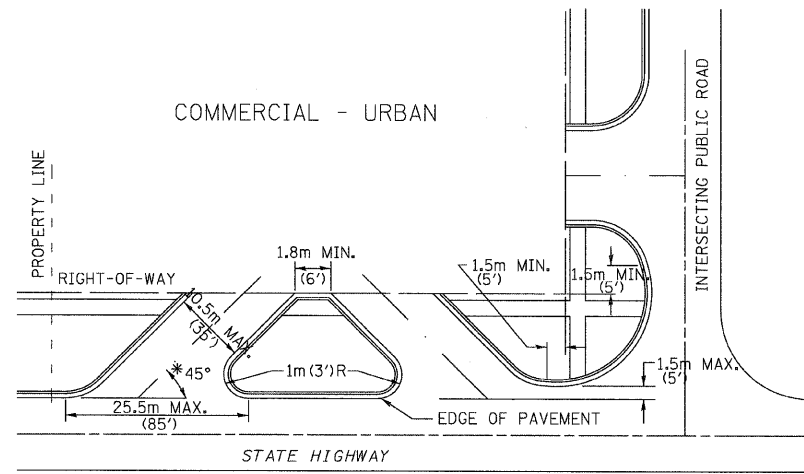

WHEN THE ISLAND BETWEEN DRIVES IS LESS THAN 7.5m (25') LONG OR LESS THAN 10 FEET WIDE, IT SHALL BE DEFINED BY CURBS, MASONRY, OR OTHER DEVICES.

* 45° MIN. ANGLE PERMITTED ONLY FOR ONE-WAY DRIVEWAYS.
60° MIN. ANGLE FOR TWO-WAY DRIVEWAYS.

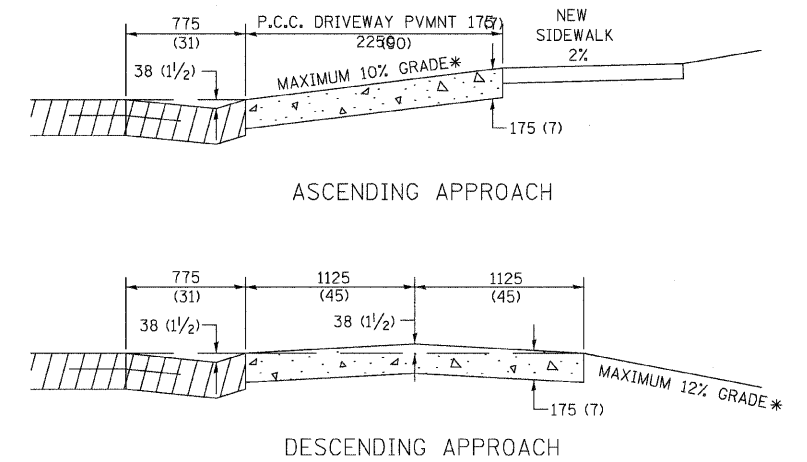
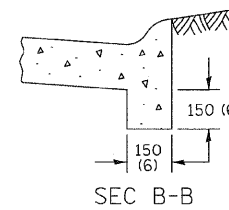
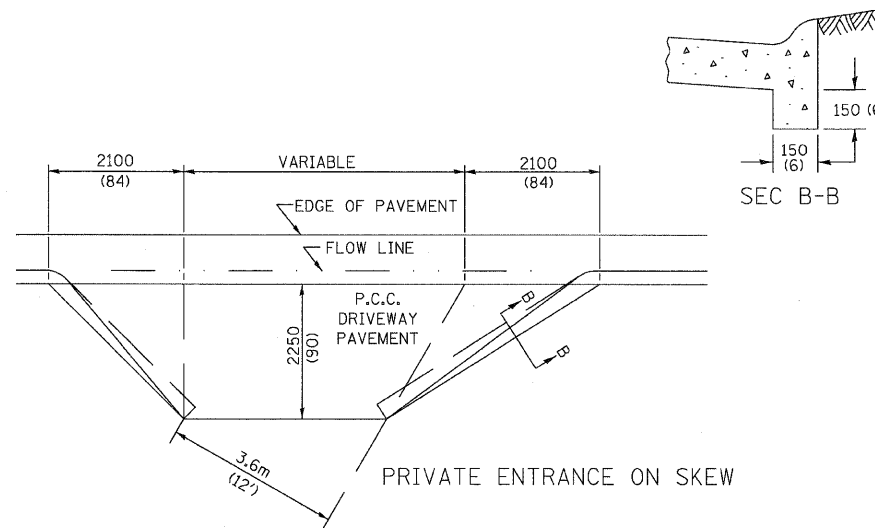
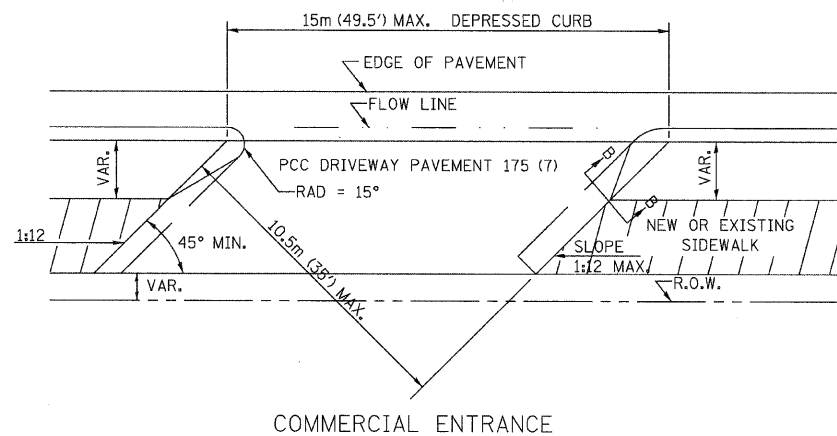

* IN CASES WHERE GRADE EXCEEDS 10%, THE RESIDENT ENGINEER SHALL CHECK WITH DISTRICT DESIGN OFFICE TO DETERMINE NEW APPROACH GRADE, PARTICULAR ATTENTION SHALL BE PAID TO THE NEGATIVE GRADE TO PREVENT DRAINAGE FROM OVER FLOWING INTO THE PRIVATE ENTRANCE.

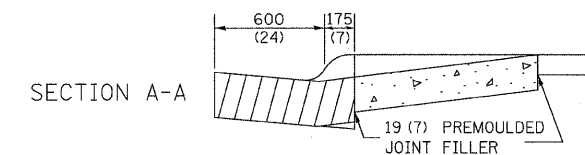
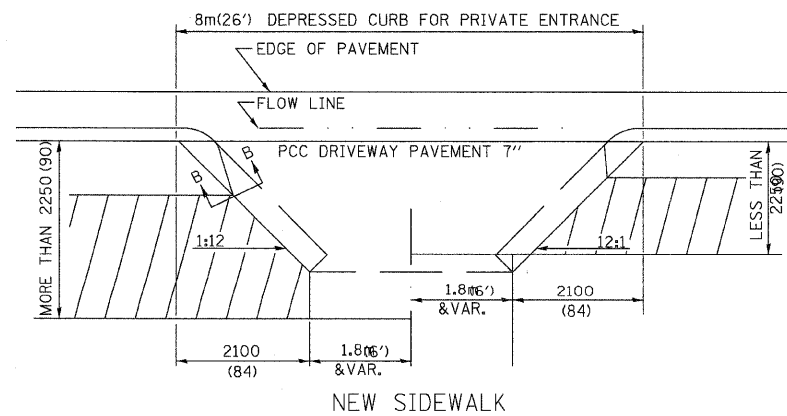
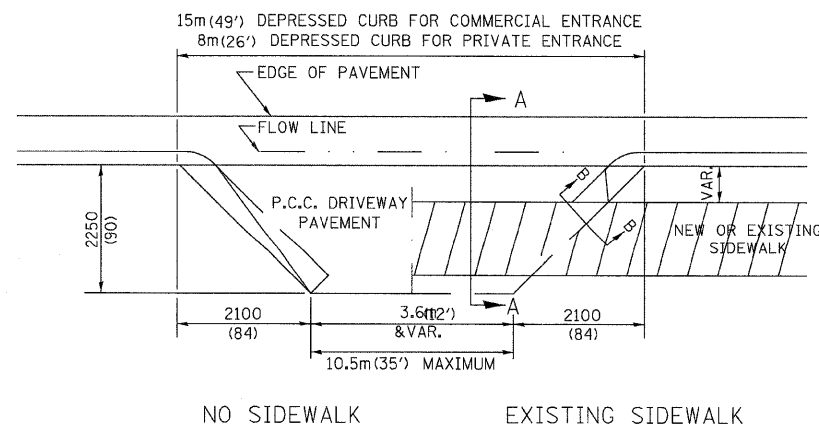

THE VARIABLE HEIGHT INTEGRAL CURB AND PREMOULDED JOINT FILLER WILL NOT BE PAID FOR SEPARATELY, BUT SHALL BE INCLUDED IN THE CONTRACT UNIT PRICE OF DRIVEWAY PAVEMENT OF THE THICKNESS SPECIFIED.

ALL DIMENSIONS ARE IN MILLIMETERS (INCHES) UNLESS OTHERWISE NOTED.

| | | | |
|-------------|--------------------|----------------|-------------------|
| FILE NAME = | USER NAME = #USER# | DESIGNED - --- | REVISED - 1-11-08 |
| #FILE# | | DRAWN - --- | REVISED - --- |
| | | CHECKED - --- | REVISED - --- |
| | | DATE - --- | REVISED - --- |

STATE OF ILLINOIS
DEPARTMENT OF TRANSPORTATION

REGION 2 / DISTRICT 2 STANDARD

| | | | | |
|-------------------------------------------------|----------------|--------|--------------|-----------|
| LOCAL RTE. | SECTION | COUNTY | TOTAL SHEETS | SHEET NO. |
| M.S. 1040 | 05-00010-00-PV | HENRY | 136 | 124 |
| CONTRACT NO. 85428 | | | | |
| FED. ROAD DIST. NO. - ILLINOIS FED. AID PROJECT | | | | |

SCALE: SHEET NO. 124 OF 136 SHEETS STA. TO STA.