

# FRAME AND GRATE FOR INLET SPECIAL

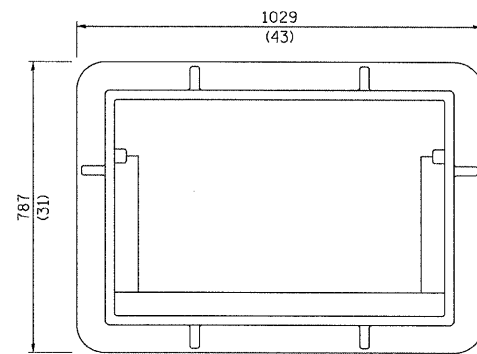

PLAN OF FRAME  
WITHOUT GRATE AND CURB BOX

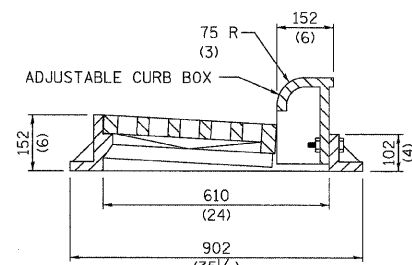

TRANSVERSE SECTION

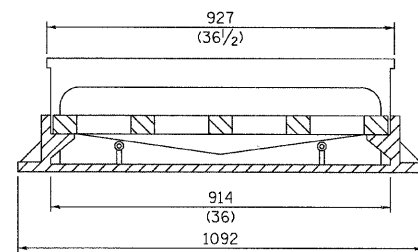

LONGITUDINAL SECTION

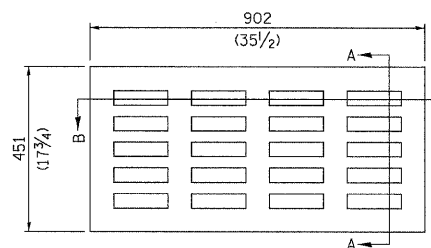

PLAN OF GRATE

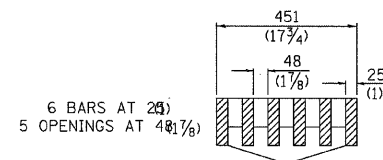

SECTION A-A

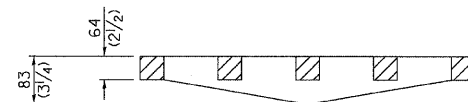

SECTION B-B

ALL DIMENSIONS ARE IN MILLIMETERS (INCHES) UNLESS OTHERWISE NOTED.

R 3246  
APPROXIMATE WEIGHT - 225 Kg. (495 LBS.)

REVISED 9-25-92

# EROSION CONTROL DETAILS FOR SILT FENCE

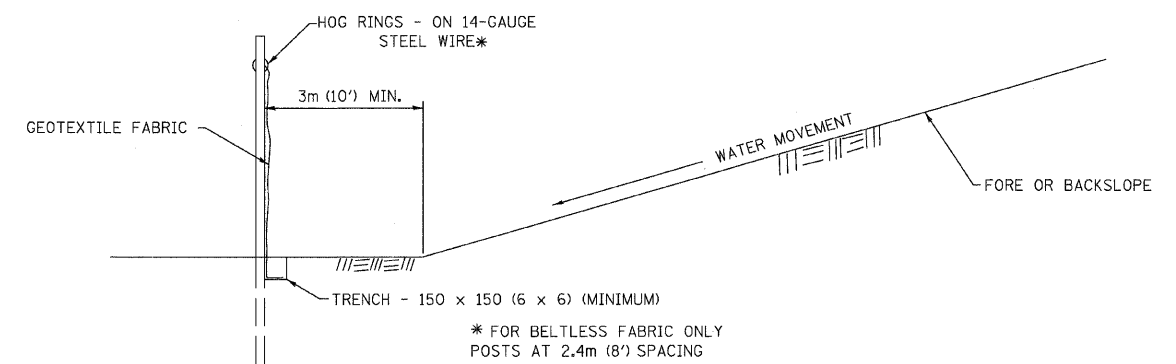
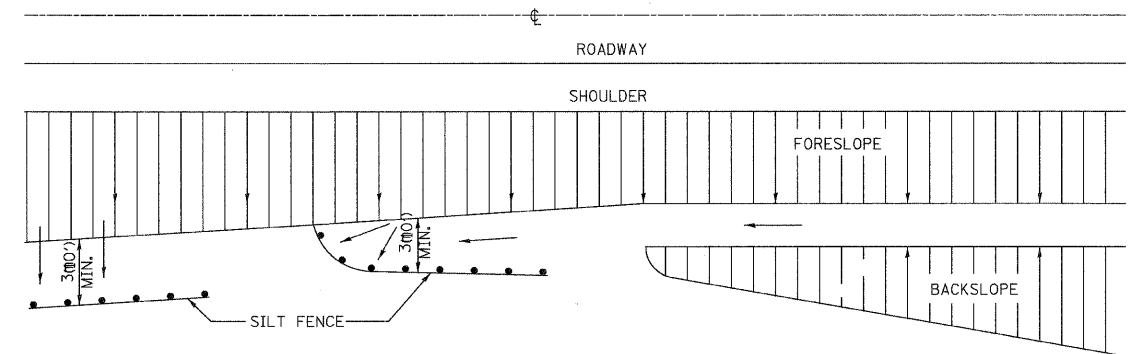

DETAILS OF SILT FENCE

ALL DIMENSIONS ARE IN MILLIMETERS (INCHES) UNLESS OTHERWISE NOTED.

REVISED - 10-22-01	REGION 2 / DISTRICT 2 STANDARD	LOCAL R.T.E. 1040	SECTION 05-00010-00-PV	COUNTY HENRY	TOTAL SHEETS 136	SHEET NO. 131
REVISED - ---	SCALE: #SCALE#	SHEET NO. 131 OF 36 SHEETS		STA. _____ TO STA. _____		CONTRACT NO. 8542B
REVISED - ---	PLLOT DATE = #DATE#	FED. ROAD DIST. NO. _____		ILLINOIS FED. AID PROJECT		