

NOTE:
 THIS WORK WILL BE PAID FOR AT THE CONTRACT UNIT PRICE EACH FOR:
 MANHOLES TO BE ADJUSTED (SPECIAL);
 MANHOLES TO BE ADJUSTED WITH NEW TYPE 1 FRAME, CLOSED LID;
 MANHOLES TO BE RECONSTRUCTED WITH NEW TYPE 1 FRAME, CLOSED LID;
 SANITARY MANHOLES TO BE ADJUSTED WITH NEW TYPE 1 FRAME, CLOSED LID;
 SANITARY MANHOLES TO BE RECONSTRUCTED;
 SANITARY MANHOLES TO BE RECONSTRUCTED WITH NEW FRAME AND LID;
 * RESTRICTED DEPTH MANHOLES, 4'-DIAMETER, TYPE 1 FRAME, CLOSED LID;
 * MANHOLES, SPECIAL, WITH TYPE 1 FRAME, CLOSED LID; AND
 * RESTRICTED DEPTH INLET TYPE B, TYPE 1 FRAME, CLOSED LID;
 WHICH PRICE SHALL INCLUDE ALL LABOR, MATERIAL, AND EQUIPMENT NECESSARY TO COMPLETE THE WORK, INCLUDING PAVEMENT REMOVAL, EXCAVATION, ADJUSTING RINGS, AND CLASS SI BLACK COLORED CONCRETE.

*SEE DETAIL A

**FRAME AND LID ADJUSTING DETAIL
 INSIDE PAVEMENT AREA**

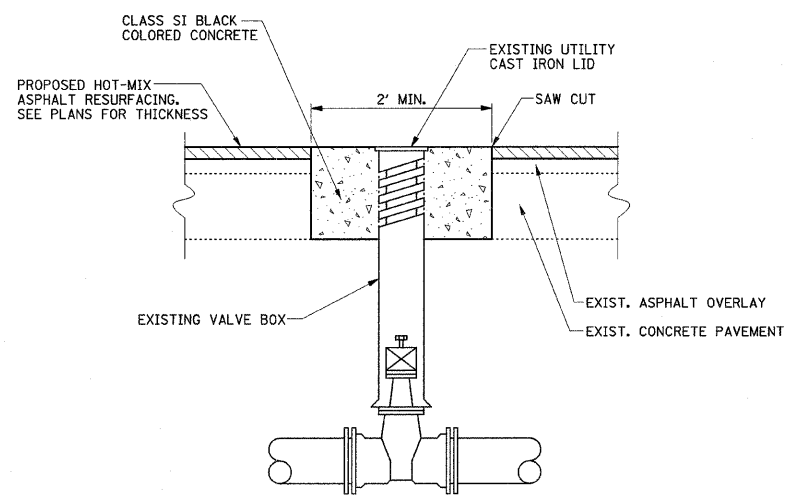

NOTE:
 THIS WORK WILL BE PAID FOR AT THE CONTRACT UNIT PRICE EACH FOR VALVE BOXES TO BE ADJUSTED (SPECIAL), WHICH PRICE SHALL INCLUDE ALL LABOR, MATERIAL, AND EQUIPMENT NECESSARY TO COMPLETE THE WORK, INCLUDING PAVEMENT REMOVAL, EXCAVATION, ADJUSTING RINGS, CLASS SI BLACK COLORED CONCRETE, AND CONCRETE STAMPING WHERE REQUIRED. THE LETTER SIZE FOR THE PROPOSED LEGEND STAMPED IN THE CONCRETE SHALL MATCH THE EXISTING LETTER SIZE.

**VALVE BOXES TO BE ADJUSTED
 (SPECIAL) DETAIL**

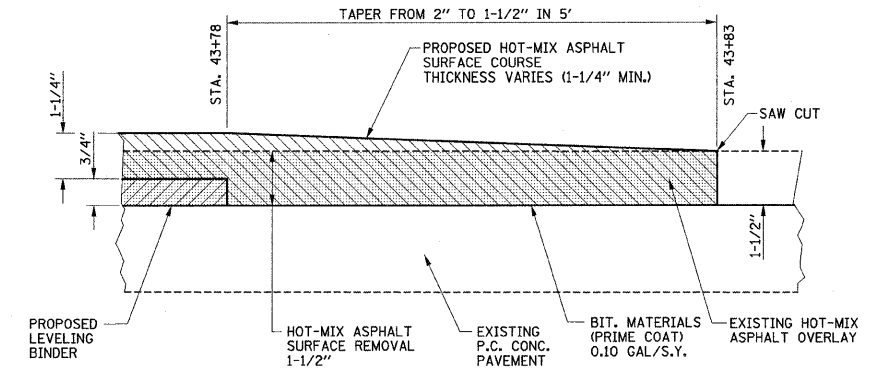

NOTE:
 THIS WORK WILL NOT BE PAID FOR SEPARATELY BUT SHALL BE INCLUDED IN THE COST OF THE HOT-MIX ASPHALT SURFACE COURSE AND NO ADDITIONAL COMPENSATION WILL BE ALLOWED. AT OTHER LOCATIONS WHERE THE PROPOSED HMA SURFACE MATCHES THE EXISTING SURFACE, THE CONTRACTOR SHALL TRANSITION THE 1/4" ELEVATION DIFFERENCE OVER 2'.

**HOT-MIX ASPHALT BUTT-JOINT DETAIL
 STA. 43+78 TO STA. 43+83**

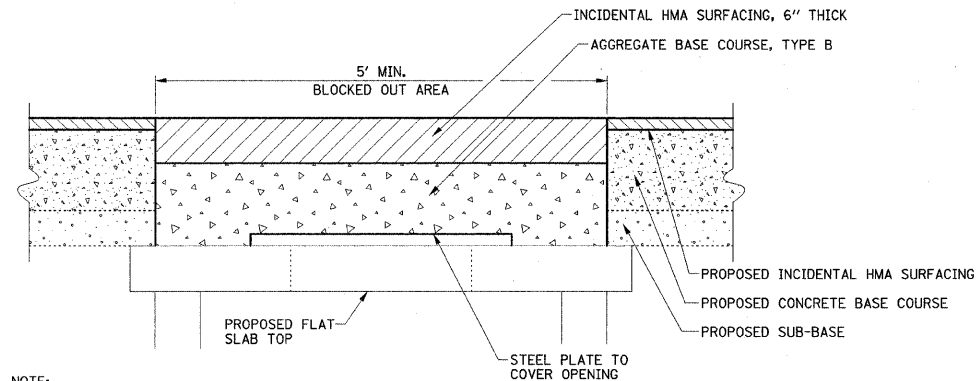

NOTE:
 THIS DETAIL IS FOR TEMPORARY PAVEMENT ABOVE PROPOSED STRUCTURES. THE TEMPORARY PAVEMENT IS REQUIRED UNTIL THE PROPOSED CASTING IS ADJUSTED TO GRADE AFTER THE HMA RESURFACING IS COMPLETE AND THE PROPOSED CONCRETE PATCH IS CONSTRUCTED. THE STEEL PLATE SHALL BE INCLUDED IN THE COST OF THE PROPOSED DRAINAGE STRUCTURE. THE INCIDENTAL HMA SURFACING AND THE AGGREGATE BASE COURSE WILL BE PAID FOR SEPARATELY. SEE THE SPECIAL PROVISIONS FOR ADDITIONAL INFORMATION.

DETAIL A

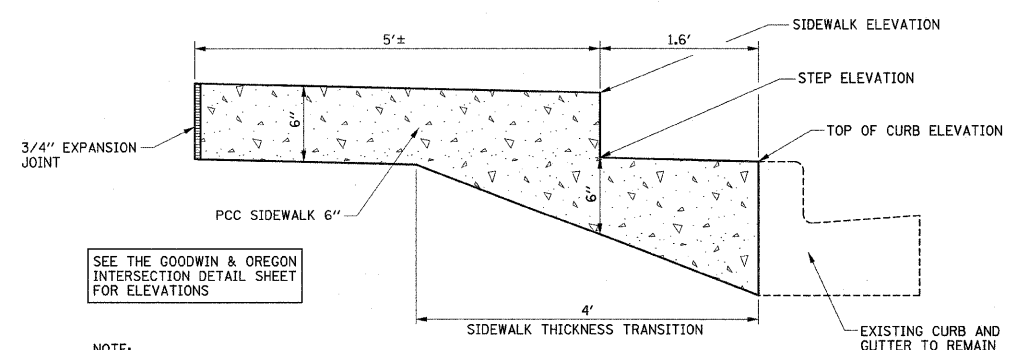

NOTE:
 THIS WORK WILL BE PAID FOR AT THE CONTRACT UNIT PRICE PER SQUARE FOOT FOR PORTLAND CEMENT CONCRETE SIDEWALK 6", AND NO ADDITIONAL COMPENSATION WILL BE ALLOWED.

CONCRETE STEP DETAIL

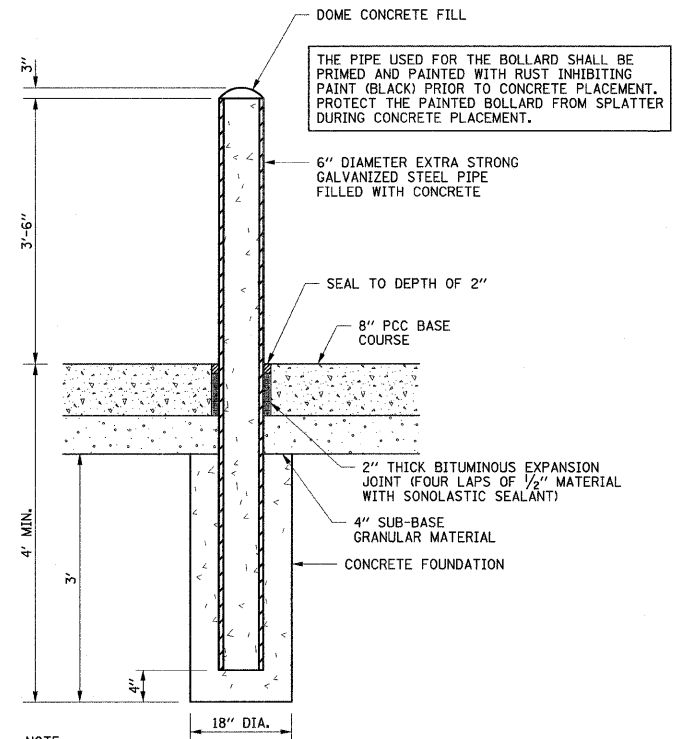

NOTE:
 THIS WORK WILL BE PAID FOR AT THE CONTRACT UNIT PRICE EACH FOR 6" DIAMETER PIPE BOLLARD, CONCRETE FILLED, WHICH PRICE SHALL INCLUDE ALL LABOR, EQUIPMENT, AND MATERIALS NECESSARY TO COMPLETE THE WORK, INCLUDING THE STEEL PIPE, CONCRETE FILLER, CONCRETE FOUNDATION, PRIMER, PAINT, EXPANSION JOINT, AND JOINT SEALANT. THE PCC BASE COURSE AND GRANULAR SUB-BASE WILL BE PAID FOR SEPARATELY.

BOLLARD DETAIL

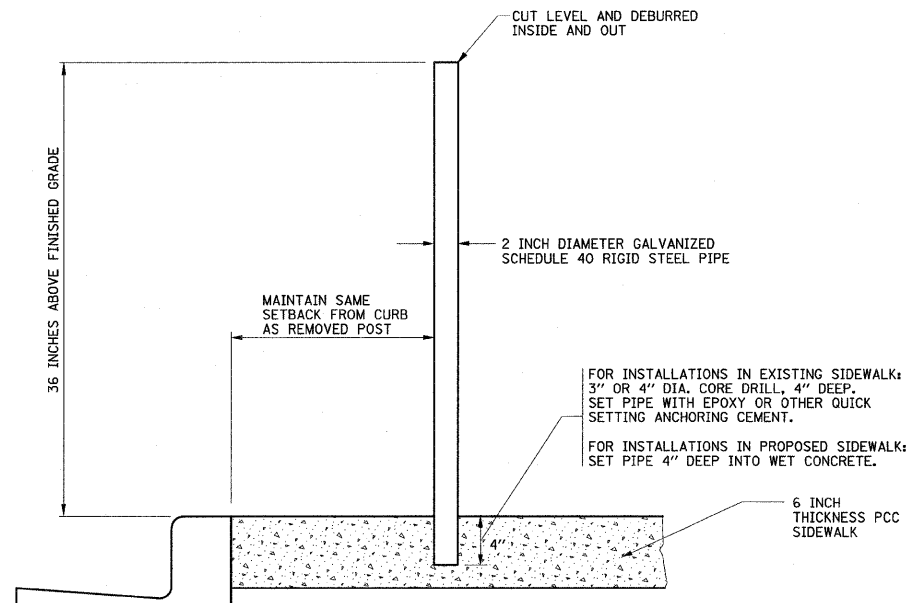

POSTS IN GRASS AREAS SHALL BE SET IN A 5 GALLON BUCKET OF CONCRETE WITH A MINIMUM OF 6" OF TOPSOIL PLACED ABOVE TOP OF BUCKET.

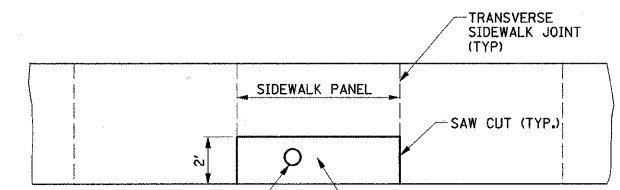

PARKING METER POST TO BE REMOVED. SIDEWALK REMOVAL AND REPLACEMENT FOR POST REMOVAL IN EXISTING SIDEWALK.

NOTE:
 THIS WORK WILL BE PAID FOR AT THE CONTRACT UNIT PRICE EACH FOR FURNISHING AND SETTING STEEL POSTS, WHICH PRICE SHALL INCLUDE ALL LABOR, MATERIAL, AND EQUIPMENT NECESSARY TO COMPLETE THE WORK, INCLUDING CORE DRILLING AND BUCKETS OF CONCRETE. SIDEWALK REMOVAL AND P.C. CONC. SIDEWALK 6" WILL BE PAID FOR SEPARATELY.

PARKING METER POST INSTALLATION

FILE NAME = p:\u0070052\plans\sheets\72-MiscDetails.dgn
 PLOT DATE = 2/27/2009 3:22:14 PM

DESIGNED - JAJ	REVISED -
DRAWN - JRM	REVISED -
CHECKED - RLH	REVISED -
DATE - 01-2009	REVISED -

STATE OF ILLINOIS
 DEPARTMENT OF TRANSPORTATION

MISCELLANEOUS DETAILS

SCALE : NONE SHEET NO. 73 OF 75 SHEETS STA. TO STA.

F.A.U. RTE.	SECTION	COUNTY	TOTAL SHEETS	SHEET NO.
7175	07-00456-00-RS	CHAMPAIGN	75	73
GOODWIN AVENUE		CONTRACT NO. 91392		
FED. ROAD DIST. NO.		ILLINOIS FED. AID PROJECT		

REVISED 4-6-09