

PROJECT NO.	081-0128 & 0129
DATE	08/08/08
DRAWN BY	G.G.
CHECKED BY	A.A.
DESIGNED BY	B.T.M.

FOR INFORMATION ONLY

LOCATION 4 Structure Numbers 081-0128 & 0129

BILL OF MATERIAL (ONE BRIDGE ONLY)

BAR NO.	SIZE	LENGTH	SHAPE
a	#5	41'-11"	U
a1	#3	40'-0"	—
a2	#6	4'-0"	—
a3	#5	45'-8"	—
b	#5	28'-2"	—
b1	#8	28'-3"	—
d	#4	4'-7"	J
d1	#5	3'-8"	J
x	#6	5'-6"	C

REINFORCEMENT	UNITS	QUANTITY
Reinforcement Bars	Lbs.	23,450
Class X Concrete	Cu. Yds.	96.8
Structural Steel	Lbs.	17,000
Waterproof Membrane Sys.	Sq. Yds.	352
Deck Surface	Ton	30
Protective Coat	Sq. Yds.	92
Preformed Jt. Sealer (2 1/2")	Lin. Ft.	47

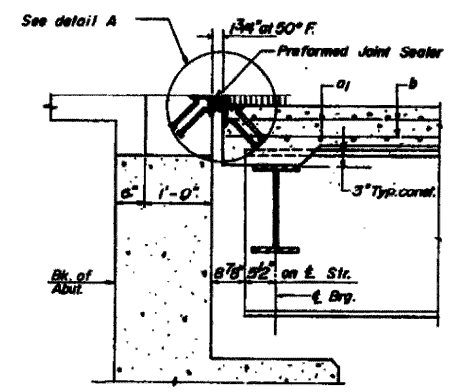

SECTION A-A
At Abuts. B & D

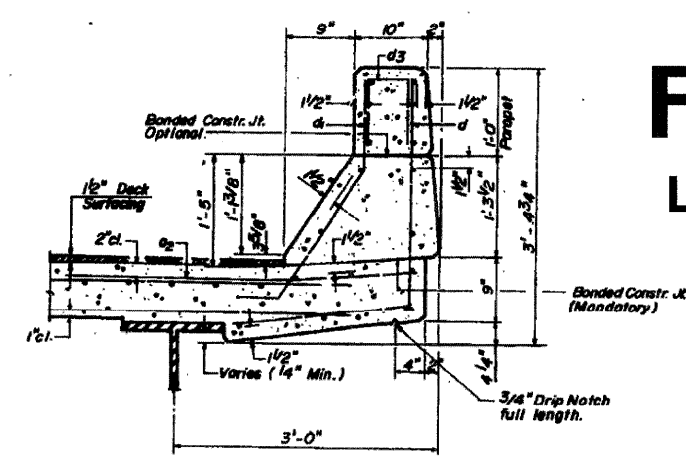

CURB SECTION

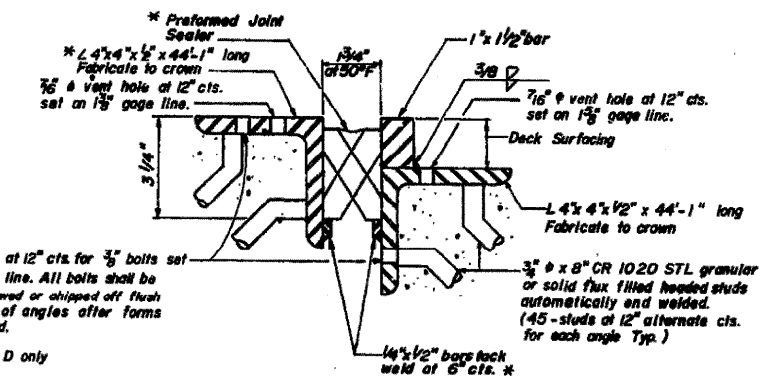

DETAIL A
Scale: 3/8"=1"

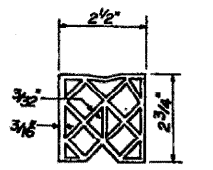

PREFORMED JOINT SEALER (2 1/2")

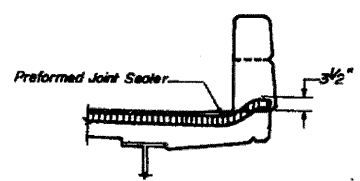

TYPICAL END OF SEALER TREATMENT

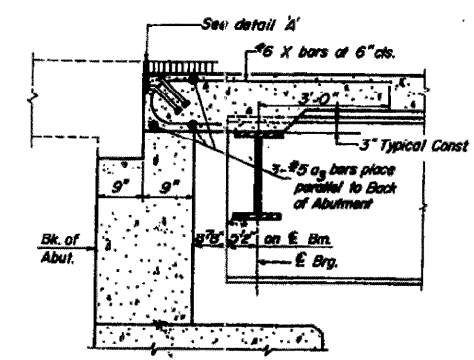

SECTION B-B
At Abuts. A & C

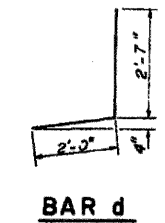

BAR d

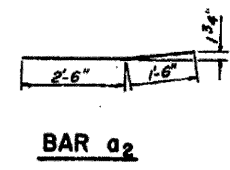

BAR a2

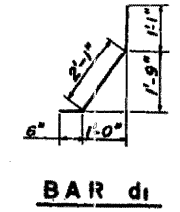

BAR d1

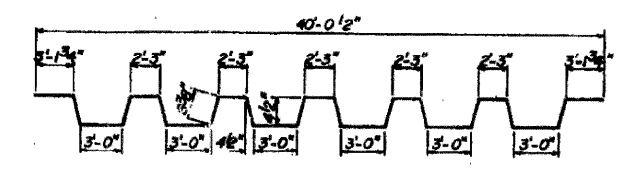

BAR a

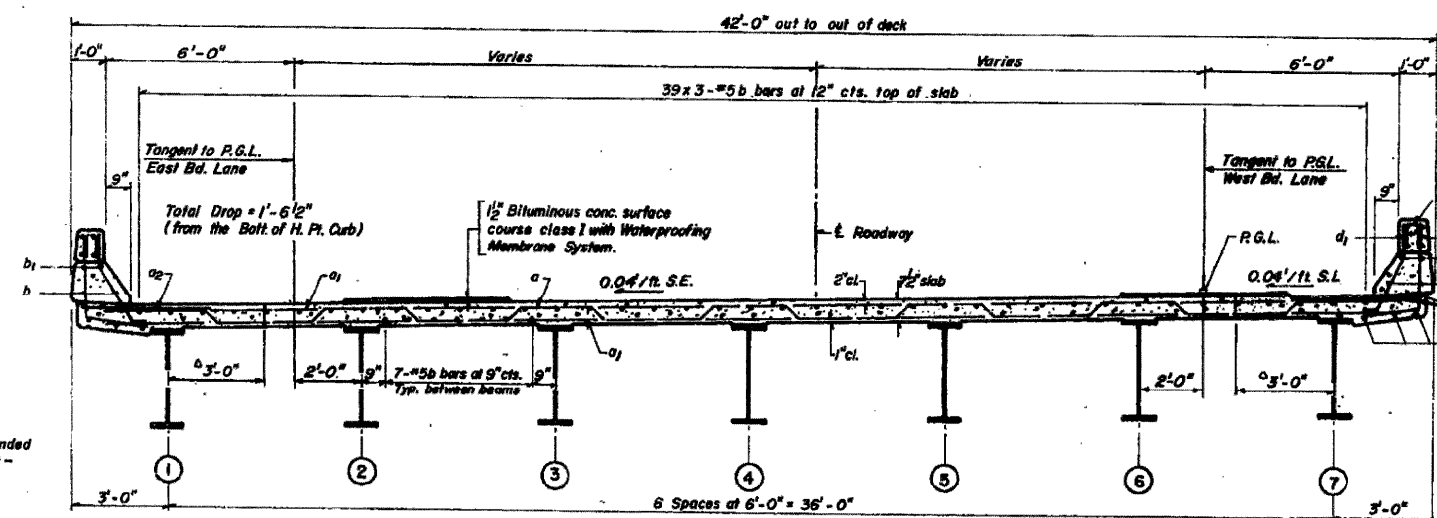

CROSS SECTION
LOOKING AHEAD STATION

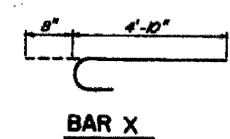

BAR X

NOTE:
a Longitudinal bonded construction joint - Do not edge.

DESIGNED	B.T.M.
CHECKED	H.R.S.
DRAWN	G.G.
CHECKED	A.A.

DECK DETAILS
FA 403 SECTION 161-18-2
FA 403 OVER CANOE CREEK
ROCK ISLAND COUNTY
* FAI ROUTES 74 & 88 STATION 710 + 50.00
** D2 BRIDGE PAINTING 2008-1