

TYPICAL PAVEMENT MARKINGS

TYPICAL PAVEMENT MARKING FOR FLUSH MEDIAN AT LEFT TURN LANE

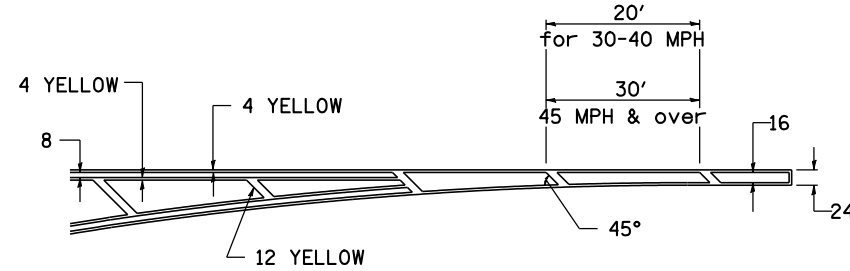

MEDIAN PAVEMENT MARKING

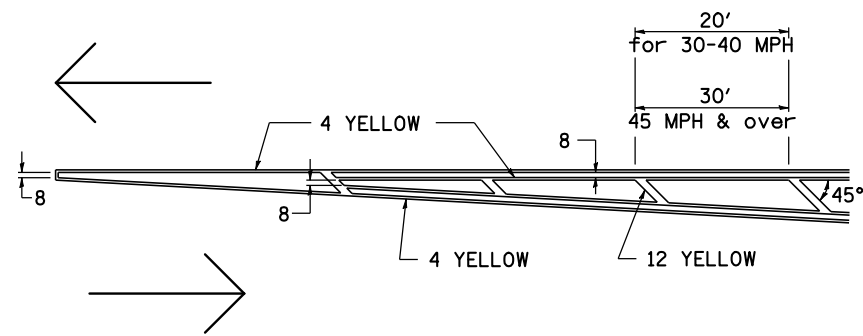
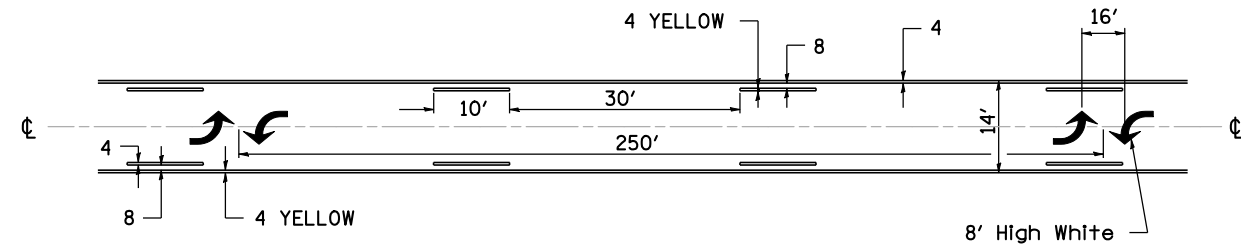

** ALL DIMENSIONS ARE IN INCHES UNLESS OTHERWISE NOTED.

TYPICAL ISLAND OFFSET SHOULDER WIDTH

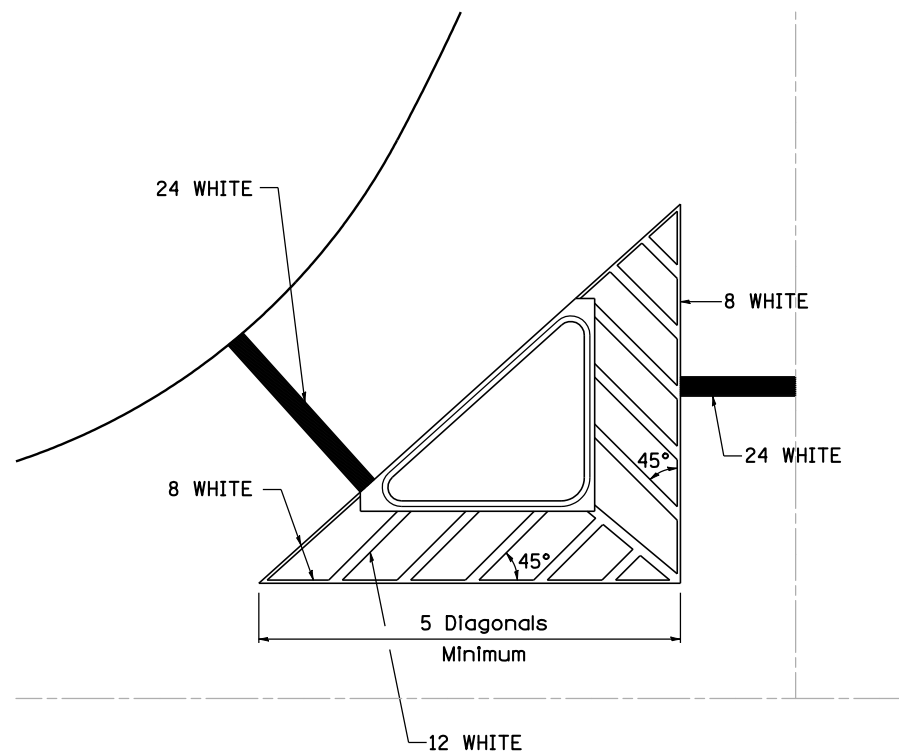

TYPICAL PARKING SPACING

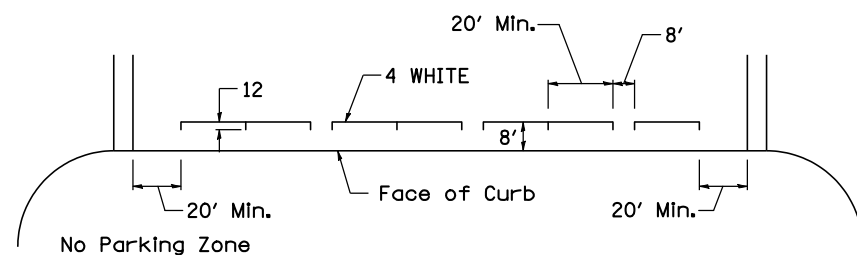
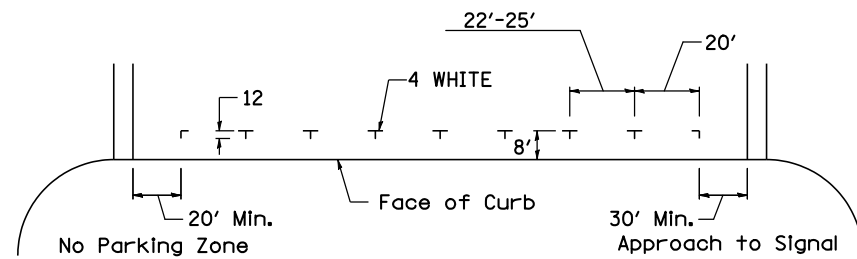
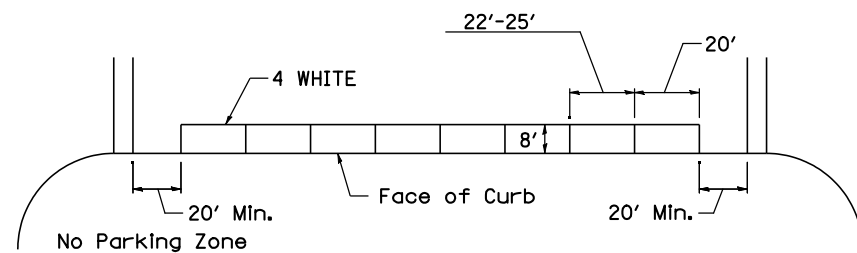

STANDARD CROSSWALK MARKING

See Schedules for Locations

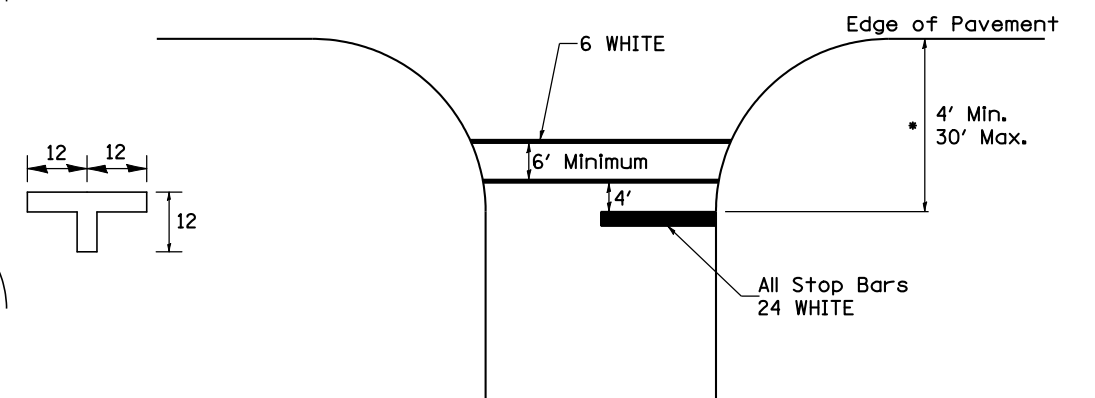

* Distance to the nearest edge of the intersecting roadway in the absence of a marked crosswalk.

FILE NAME =	USER NAME = dennisw	DESIGNED -	REVISED - 3-5-12	STATE OF ILLINOIS DEPARTMENT OF TRANSPORTATION	REGION 2 / DISTRICT 2 STANDARD			F.A.P. RTE.	SECTION	COUNTY	TOTAL SHEETS	SHEET NO.
S:\JOL\6300--6399\6346\025\Micros\Shd\0264C17-sht-districtdetails.dgn	264C17-sht-districtdetails.dgn	DRAWN -	REVISED -					646	101 BR-3	WHITESIDE	113	101
PLOT SCALE = 2.0000' / IN.		CHECKED -	REVISED -		SCALE:			SHEET NO.	OF SHEETS	STA.	TO STA.	CONTRACT NO. 64C17
PLOT DATE = 10/12/2012		DATE -	REVISED -		FED. ROAD DIST. NO. 2 [ILLINOIS] FED. AID PROJECT							