

PANEL SIGN DESIGN TYPE 1

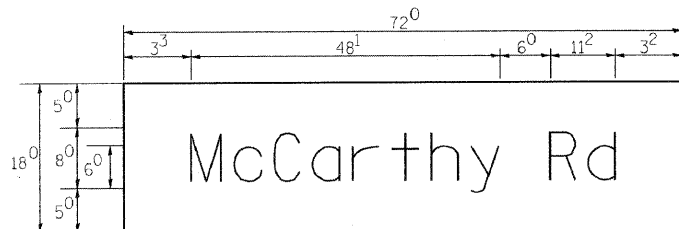

— Sq. Ft. each  
 9.0 Sq. Ft. each  
 — 3 Required  
 Design Series D

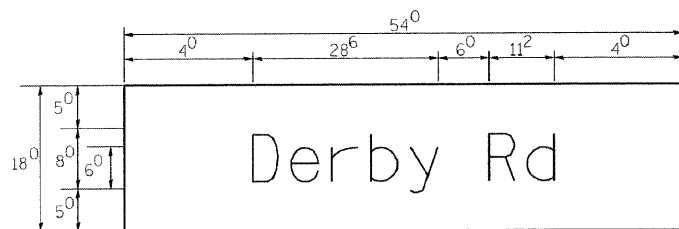

— Sq. Ft. each  
 6.75 Sq. Ft. each  
 — 4 Required  
 Design Series D

NOTE: SIGN DIMENSIONS ARE IN ENGLISH UNITS

PANEL SIGN DESIGN TYPE 2

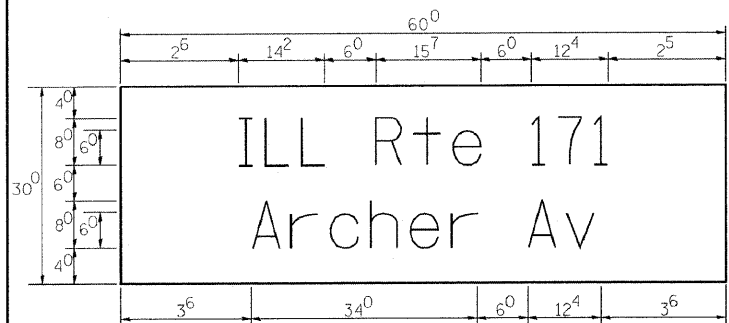

— Sq. Ft. each  
 12.5 Sq. Ft. each  
 — 4 Required  
 Design Series D

SUPPORTING CHANNELS

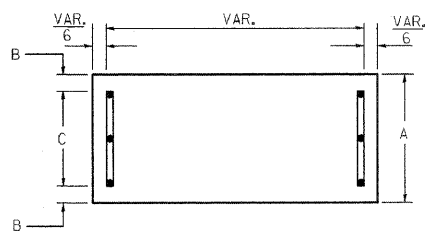

A	B	C
18"	2"	14"

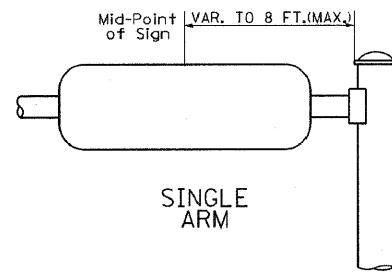

SUPPORTING CHANNELS

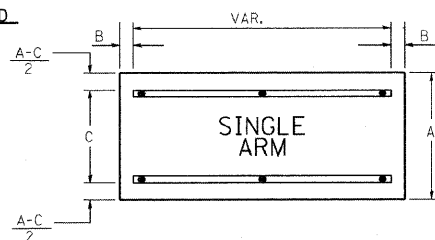

A	B	C
18"	2"	12"
30"	2"	22"

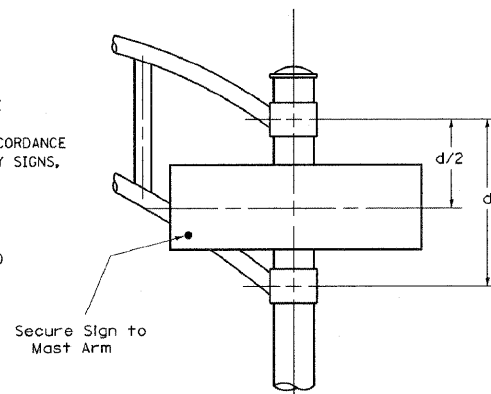

SIGNFIX ALUMINUM CHANNEL FRAMING SYSTEM  
 Shall be used. See Note #5.

Upper Case To Lower Case  
 Spacing Chart 8-6 Inch Series "C & D"

FIRST LETTER	SECOND LETTER																	
	a c d e		g o q		b h i k l		m n p r u		f w		j		s t		v y		x z	
	C	D	C	D	C	D	C	D	C	D	C	D	C	D	C	D	C	D
A W X	12	14	14	15	12	14	06	10	11	14	06	10	11	12	12	14	12	14
B	14	15	20	21	14	15	11	12	14	15	12	14	12	14	16	17		
C E G	14	15	20	21	12	14	06	10	12	14	12	14	14	15	14	15		
D O O R	14	15	20	21	14	15	06	10	12	14	12	14	14	15	14	15		
F	05	06	14	15	06	10	05	06	06	10	06	10	06	10	11	12		
H I M N	20	21	22	24	20	21	14	15	16	17	16	17	20	21	20	21		
J U	20	21	20	21	16	17	14	15	16	17	16	17	16	17	20	21		
K L	11	12	16	17	11	12	05	06	11	12	11	12	11	12	12	14		
P	12	14	14	15	12	14	05	06	11	12	11	12	12	14	12	14		
S	12	14	16	17	12	14	06	10	12	14	12	14	12	14	12	14		
T	11	12	16	17	06	10	06	10	11	12	11	12	11	12	12	14		
V	06	10	14	15	11	12	06	10	12	14	12	14	12	14	12	14		
Y	05	06	14	15	06	10	05	06	05	07	05	06	06	10	11	12		
Z	16	17	22	24	16	17	12	14	16	17	16	17	16	17	20	21		

Lower Case To Lower Case  
 Spacing Chart 6 Inch Series "C & D"

FIRST LETTER	SECOND LETTER																	
	a c d e		g o q		b h i k l		m n p r u		f w		j		s t		v y		x z	
	C	D	C	D	C	D	C	D	C	D	C	D	C	D	C	D	C	D
a d h g i j	16	17	22	24	16	17	12	14	14	15	14	15	16	17	16	17		
l m n q u																		
b f k o p s	12	14	16	17	11	12	05	06	11	12	11	12	12	14	12	14		
c e	12	14	16	17	12	14	06	10	12	14	12	14	12	14	12	14		
r	06	10	12	14	06	10	03	03	05	06	05	06	06	10	06	10		
t z	12	14	16	17	12	14	06	10	11	12	11	12	12	14	12	14		
v y	11	12	14	15	11	12	05	06	06	10	06	10	11	12	11	12		
w	11	12	14	15	11	12	05	06	11	12	11	12	11	12	12	14		
x	12	14	16	17	11	12	05	06	11	12	11	12	11	12	12	14		

Number To Number  
 Spacing Chart 8 Inch Series "C & D"

FIRST NUMBER	SECOND NUMBER																			
	0		1		2		3		4		5		6		7		8		9	
	C	D	C	D	C	D	C	D	C	D	C	D	C	D	C	D	C	D	C	D
0 9	16	17	16	17	14	15	12	14	14	15	14	15	16	17	12	14	16	17	16	17
1	20	21	20	21	20	21	16	17	14	15	20	21	20	21	14	15	20	21	20	21
2 3 4	14	15	14	15	14	15	12	14	12	14	14	15	14	15	11	12	16	17	14	15
5	14	15	14	15	14	15	11	12	11	12	14	15	14	15	11	12	14	15	14	15
6	16	17	14	15	14	15	12	14	14	15	14	15	11	12	14	15	14	15	14	15
7	12	14	12	14	14	15	12	15	05	06	12	14	14	15	11	12	14	15	12	14
8	16	17	16	17	14	15	12	15	12	14	14	15	16	17	12	14	16	17	14	15

EXAMPLE, 2<sup>3</sup> DENOTES 3" / 8"

UPPER AND LOWER CASE  
 LETTER WIDTHS

LETTERS	6 INCH UPPER CASE LETTERS				8 INCH UPPER CASE LETTERS				LETTERS	6 INCH LOWER CASE LETTERS	
	SERIES		SERIES		SERIES		SERIES			SERIES	
	C	D	C	D	C	D	C	D		C	D
A	3 <sup>6</sup>	5 <sup>0</sup>	5 <sup>0</sup>	6 <sup>5</sup>	a	3 <sup>5</sup>	4 <sup>2</sup>				
B	3 <sup>2</sup>	4 <sup>0</sup>	4 <sup>3</sup>	5 <sup>3</sup>	b	3 <sup>5</sup>	4 <sup>2</sup>				
C	3 <sup>2</sup>	4 <sup>0</sup>	4 <sup>3</sup>	5 <sup>3</sup>	c	3 <sup>5</sup>	4 <sup>1</sup>				
D	3 <sup>2</sup>	4 <sup>0</sup>	4 <sup>3</sup>	5 <sup>3</sup>	d	3 <sup>5</sup>	4 <sup>2</sup>				
E	3 <sup>0</sup>	3 <sup>5</sup>	4 <sup>0</sup>	4 <sup>7</sup>	e	3 <sup>5</sup>	4 <sup>2</sup>				
F	3 <sup>0</sup>	3 <sup>5</sup>	4 <sup>0</sup>	4 <sup>7</sup>	f	2 <sup>3</sup>	2 <sup>6</sup>				
G	3 <sup>2</sup>	4 <sup>0</sup>	4 <sup>3</sup>	5 <sup>3</sup>	g	3 <sup>5</sup>	4 <sup>2</sup>				
H	3 <sup>2</sup>	4 <sup>0</sup>	4 <sup>3</sup>	5 <sup>3</sup>	h	3 <sup>5</sup>	4 <sup>2</sup>				
I	0 <sup>7</sup>	0 <sup>7</sup>	1 <sup>1</sup>	1 <sup>2</sup>	i	1 <sup>1</sup>	1 <sup>1</sup>				
J	3 <sup>0</sup>	3 <sup>6</sup>	4 <sup>0</sup>	5 <sup>0</sup>	j	2 <sup>0</sup>	2 <sup>2</sup>				
K	3 <sup>2</sup>	4 <sup>1</sup>	4 <sup>3</sup>	5 <sup>4</sup>	k	3 <sup>5</sup>	4 <sup>2</sup>				
L	3 <sup>0</sup>	3 <sup>5</sup>	4 <sup>0</sup>	4 <sup>7</sup>	l	1 <sup>1</sup>	1 <sup>1</sup>				
M	3 <sup>7</sup>	4 <sup>5</sup>	5 <sup>1</sup>	6 <sup>1</sup>	m	6 <sup>0</sup>	7 <sup>0</sup>				
N	3 <sup>2</sup>	4 <sup>0</sup>	4 <sup>3</sup>	5 <sup>3</sup>	n	3 <sup>5</sup>	4 <sup>2</sup>				
O	3 <sup>4</sup>	4 <sup>2</sup>	4 <sup>5</sup>	5 <sup>5</sup>	o	3 <sup>6</sup>	4 <sup>3</sup>				
P	3 <sup>2</sup>	4 <sup>0</sup>	4 <sup>3</sup>	5 <sup>3</sup>	p	3 <sup>5</sup>	4 <sup>2</sup>				
Q	3 <sup>4</sup>	4 <sup>2</sup>	4 <sup>5</sup>	5 <sup>5</sup>	q	3 <sup>5</sup>	4 <sup>2</sup>				
R	3 <sup>2</sup>	4 <sup>0</sup>	4 <sup>3</sup>	5 <sup>3</sup>	r	2 <sup>6</sup>	3 <sup>2</sup>				
S	3 <sup>2</sup>	4 <sup>0</sup>	4 <sup>3</sup>	5 <sup>3</sup>	s	3 <sup>6</sup>	4 <sup>2</sup>				
T	3 <sup>0</sup>	3 <sup>5</sup>	4 <sup>0</sup>	4 <sup>7</sup>	t	2 <sup>7</sup>	3 <sup>2</sup>				
U	3 <sup>2</sup>	4 <sup>0</sup>	4 <sup>3</sup>	5 <sup>3</sup>	u	3 <sup>5</sup>	4 <sup>2</sup>				
V	3 <sup>5</sup>	4 <sup>4</sup>	4 <sup>7</sup>	6 <sup>0</sup>	v	4 <sup>2</sup>	4 <sup>7</sup>				
W	4 <sup>4</sup>	5 <sup>2</sup>	6 <sup>0</sup>	7 <sup>0</sup>	w	5 <sup>5</sup>	6 <sup>4</sup>				
X	3 <sup>4</sup>	4 <sup>0</sup>	4 <sup>5</sup>	5 <sup>3</sup>	x	4 <sup>4</sup>	5 <sup>1</sup>				
Y	3 <sup>6</sup>	5 <sup>0</sup>	5 <sup>0</sup>	6 <sup>6</sup>	y	4 <sup>6</sup>	5 <sup>3</sup>				
Z	3 <sup>2</sup>	4 <sup>0</sup>	4 <sup>3</sup>	5 <sup>3</sup>	z	3 <sup>6</sup>	4 <sup>3</sup>				

NUMBER	6 INCH SERIES		8 INCH SERIES	
	C	D	C	D
1	1 <sup>2</sup>	1 <sup>4</sup>	1 <sup>5</sup>	2 <sup>0</sup>
2	3 <sup>2</sup>	4 <sup>0</sup>	4 <sup>3</sup>	5 <sup>3</sup>
3	3 <sup>2</sup>	4 <sup>0</sup>	4 <sup>3</sup>	5 <sup>3</sup>
4	3 <sup>5</sup>	4 <sup>3</sup>	4 <sup>7</sup>	5 <sup>7</sup>
5	3 <sup>2</sup>	4 <sup>0</sup>	4 <sup>3</sup>	5 <sup>3</sup>
6	3 <sup>2</sup>	4 <sup>0</sup>	4 <sup>3</sup>	5 <sup>3</sup>
7	3 <sup>2</sup>	4 <sup>0</sup>	4 <sup>3</sup>	5 <sup>3</sup>
8	3 <sup>2</sup>	4 <sup>0</sup>	4 <sup>3</sup>	5 <sup>3</sup>
9	3 <sup>2</sup>	4 <sup>0</sup>	4 <sup>3</sup>	5 <sup>3</sup>
0	3 <sup>4</sup>	4 <sup>2</sup>	4 <sup>5</sup>	5 <sup>5</sup>

GENERAL NOTES

- WHERE MAST ARM MOUNTED STREET NAME SIGNS ARE SPECIFIED, THE MAST ARM ASSEMBLY AND POLES SHALL BE DESIGNED TO SUPPORT THE LOADINGS CALLED FOR ON STANDARDS 877001, 877002, 877006, 877011 AND 877012. AS APPLICABLE, PLUS TWO (2) SIGN PANELS 2'-6" x 8'-0" MOUNTED AS SHOWN. THE DESIGN SHALL BE IN ACCORDANCE WITH THE REQUIREMENTS OF THE CURRENT "STANDARD SPECIFICATIONS FOR STRUCTURAL SUPPORTS FOR HIGHWAY SIGNS, LUMINAIRES, AND TRAFFIC SIGNALS" AS PUBLISHED BY THE AMERICAN ASSOCIATION OF STATE HIGHWAY AND TRANSPORTATION OFFICIALS FOR 80 M.P.H. WIND VELOCITY.
- ALL SIGNS SHALL HAVE A WHITE REFLECTORIZED LEGEND AND BORDER ON A GREEN REFLECTORIZED BACKGROUND, TYPE A SHEETING.
- THE SIGN LENGTH SHOULD BE INCREASED IN 6-INCH INCREMENTS, BUT THE OVERALL LENGTH SHOULD NOT EXCEED 8'-0".
- ALL BORDERS SHALL BE 3/4" WIDE AND CORNER RADIUS SHALL BE 2-1/4".
- SIGNFIX ALUMINUM CHANNEL FRAMING SYSTEM SHALL BE USED FOR ALL SIGNS ATTACHED TO SIGNAL POLES AND POSTS. LOCAL SUPPLIERS OF THE SIGNFIX ALUMINUM CHANNEL FRAMING SYSTEM ARE:

\* J.O. HERBERT CO. MIDLOTHIAN, VA. \* WESTERN REMAC INC. WOODRIDGE, IL.

PARTS LISTING:  
 SIGN CHANNEL PART #HPN053 (MED. CHANNEL)  
 SIGN SCREWS 1/4" x 14 x 1" H.W.H. #3  
 BRACKETS PART #HPN034 (UNIVERSAL)  
 CHANNEL CLAMPS WITH STAINLESS STEEL STRAPPING  
 OTHER BRANDS OF MOUNTING HARDWARE ARE ACCEPTABLE, BASED UPON THE DEPARTMENT'S APPROVAL AND COMPATIBILITY WITH THE CHANNEL/BRACKET OF THE ABOVE PRODUCT.

FILE NAME =	USER NAME =	DESIGNED - DAG/BCK	REVISED - DAG 10/28/09
...sign\124-stname.dgn		DRAWN - BCK	REVISED -
		CHECKED - DAG/DAD	REVISED -
		DATE - 3/15/2009	REVISED -

STATE OF ILLINOIS  
 DEPARTMENT OF TRANSPORTATION

DISTRICT 1  
 MAST ARM MOUNTED STREET NAME SIGNS

SCALE: NONE SHEET NO. OF SHEETS STA. TO STA.

**KLOA**  
 Kanig, Lindgren, O'Hara, Aboona, Inc.  
 9575 West Higgins Road, Suite 400  
 Rosemont, Illinois 60018  
 P: (847) 516-9980 F: (847) 518-9887  
 PROJECT # 10-001

F.A. RTE.	SECTION	COUNTY	TOTAL SHEETS	SHEET NO.
VAR.	02-00055-00-WR	COOK	84	69
CONTRACT NO. 63557				
FED. ROAD DIST. NO. ILLINOIS FED. AID PROJECT HFP-N-8003(504)				