

ROUTE NO.	SECTION	COUNTY	TOTAL SHEETS	SHEET NO.
FAS 721	05-00111-00-RS	FAYETTE	7	4
FEDERAL AID PROJECT		ILLINOIS	PROJECT RS-0721 (221)	
CONTRACT NO. 95645				

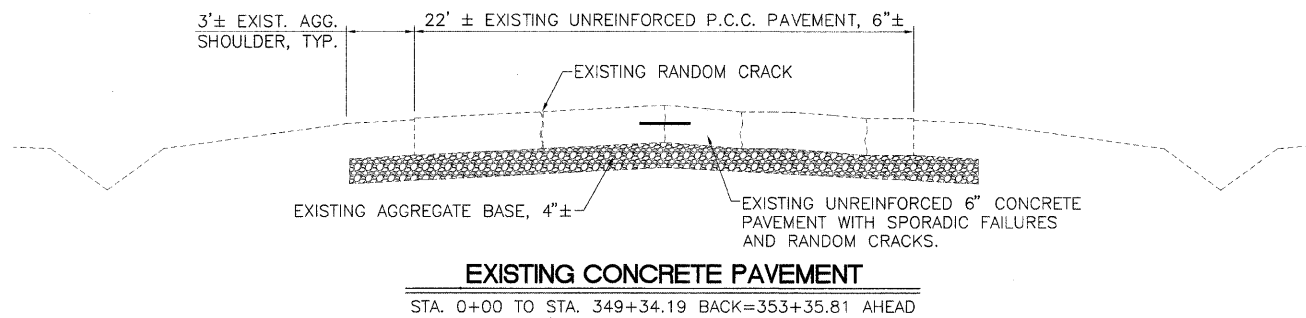

**EXISTING CONCRETE PAVEMENT**  
 STA. 0+00 TO STA. 349+34.19 BACK=353+35.81 AHEAD

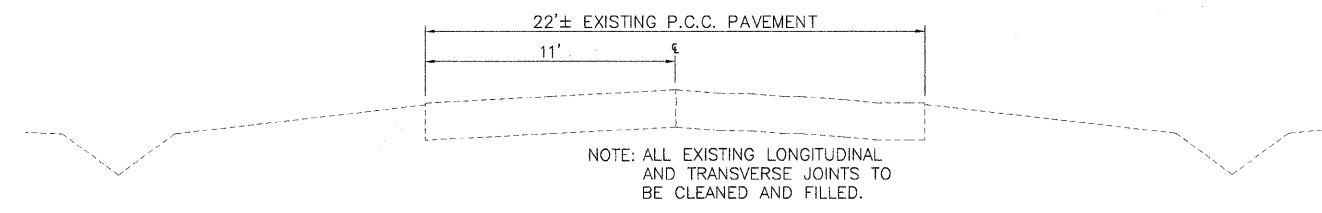

**PROPOSED TYPICAL SECTION - A**  
 STA. 0+00 TO STA. 349+34.19 BACK=353+35.81 AHEAD

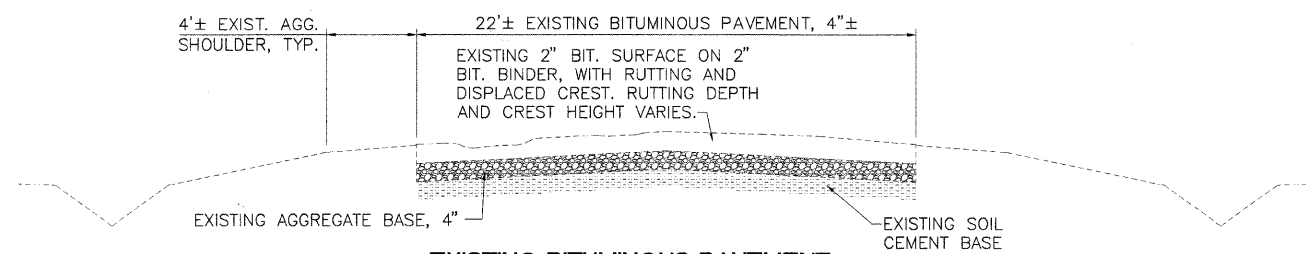

**EXISTING BITUMINOUS PAVEMENT**  
 STA. 349+34.19 BACK = 353+35.81 AHEAD TO STA. 359+00  
 STA. 373+50 TO STA. 375+81.81  
 STA. 379+15.35 TO STA. 381+50  
 STA. 414+50 TO STA. 418+23

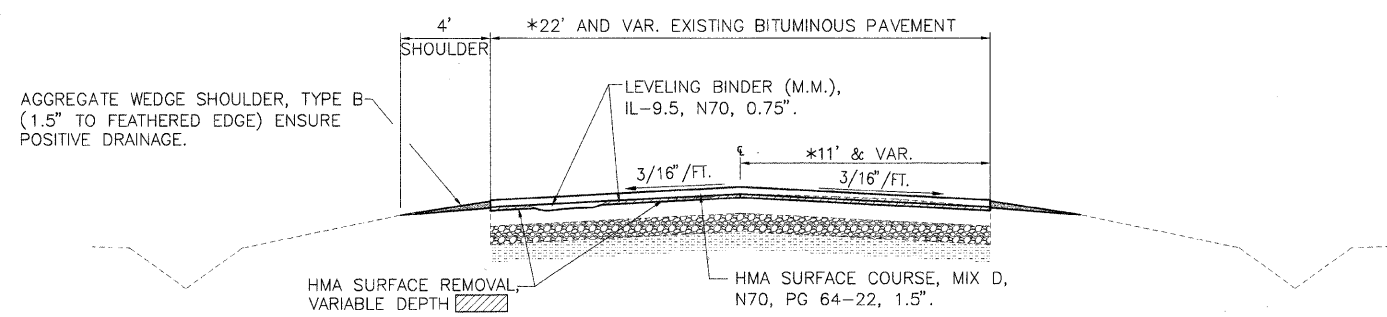

**PROPOSED TYPICAL SECTION - B**  
 STA. 349+34.19 BACK=353+35.81 AHEAD TO STA. 418+23  
 BRIDGE OMISSION STA. 375+81.81 TO STA. 379+15.35  
 \*VARIABLE WIDTH PER TRANSITION STA. 418+23 TO STA. 419+73

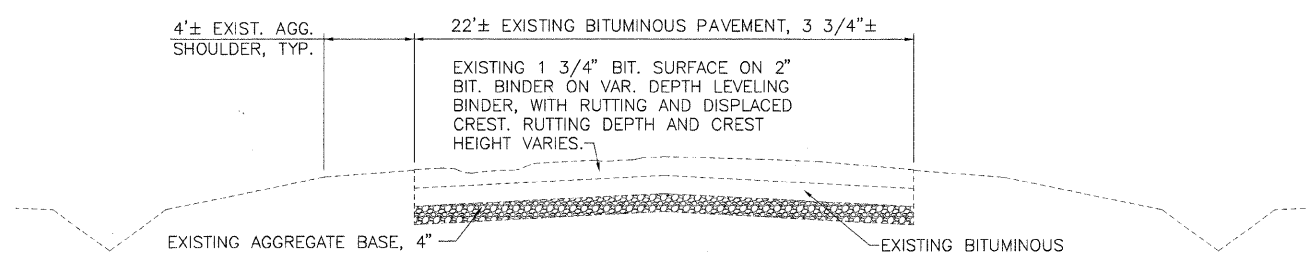

**EXISTING BITUMINOUS PAVEMENT**  
 STA. 359+00 TO STA. 373+50  
 STA. 381+50 TO STA. 414+50

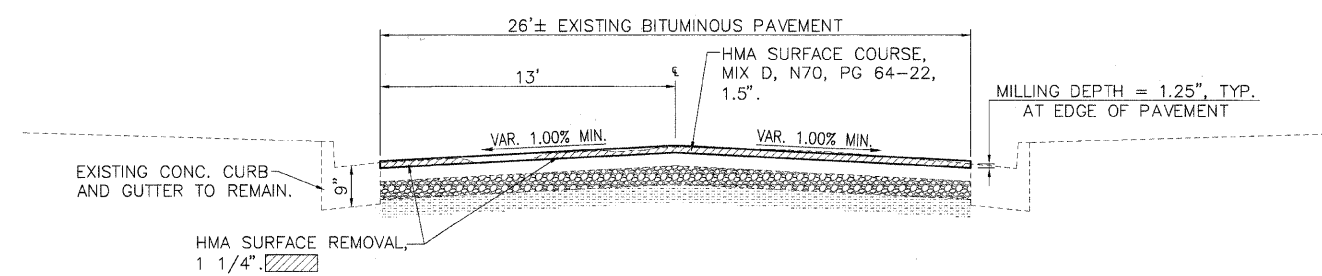

**PROPOSED TYPICAL SECTION - C**  
 STA. 419+73 TO STA. 463+64.84

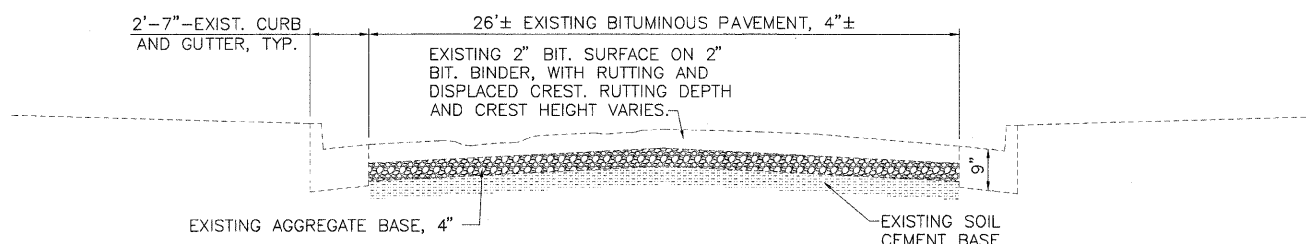

**EXISTING BITUMINOUS PAVEMENT WITH CURB AND GUTTER**  
 STA. 419+73 TO STA. 463+64.84