

F.A.P. RTE.	SECTION	COUNTY	TOTAL SHEETS	SHEET NO.
541	(X-R & T-13-A) RS-1	LAKE	29	1
FED. ROAD DIST. NO. 1		ILLINOIS	CONTRACT NO. 60G78	

STATE OF ILLINOIS
DEPARTMENT OF TRANSPORTATION
DIVISION OF HIGHWAYS

PROPOSED
HIGHWAY PLANS

FAP 541 / IL. RTE. 132 (GRAND AVENUE)
SECTION: (X-R & T-13-A) RS-1
U.S. 45 TO I-94 RAMP (IL. RTE. 132 (EB) TO I-94 (SB))
RESURFACING (3P)

LAKE COUNTY
C-91-534-09

FOR INDEX OF SHEETS, SEE SHEET NO. 2

DESIGN DESIGNATION:
SPEED LIMIT : 40 M.P.H. TO 50 M.P.H.
2007 ADT = 43,000

PROJECT LOCATED IN THE VILLAGE OF GURNEE

D-91-534-09



LOCATION OF SECTION INDICATED THIS: - [shaded area] -

PROJECT BEGINS STA. 8 + 00

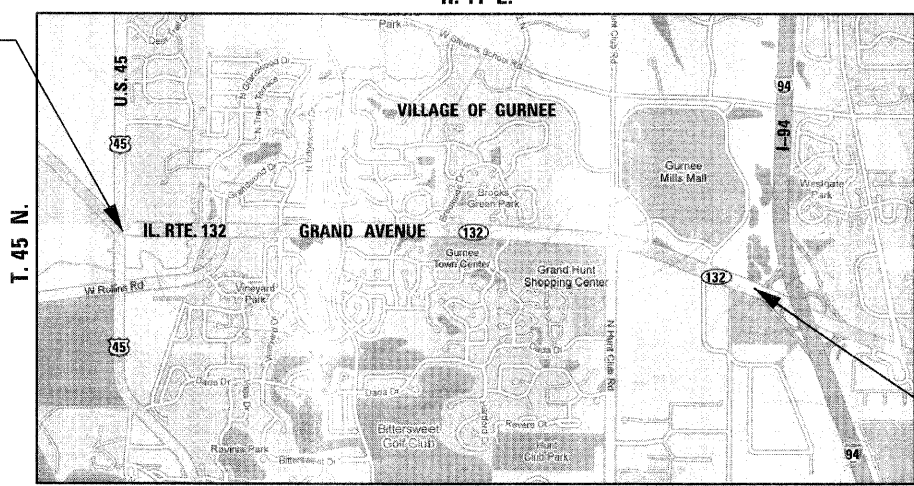

PROJECT ENDS STA. 151 + 86

GROSS LENGTH OF PROJECT = 14,386 FEET = 2.725 MILES
NET LENGTH OF PROJECT = 14,386 FEET = 2.725 MILES

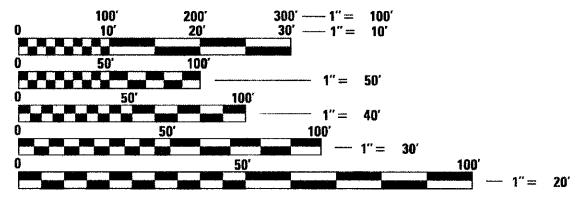

FULL SIZE PLANS HAVE BEEN PREPARED USING STANDARD ENGINEERING SCALES. REDUCED SIZED PLANS WILL NOT CONFORM TO STANDARD SCALES. IN MAKING MEASUREMENTS ON REDUCED PLANS, THE ABOVE SCALES MAY BE USED.

J.U.L.I.E.
 JOINT UTILITY LOCATING INFORMATION FOR EXCAVATORS
 1-800-892-0123
 OR 811

DISTRICT ONE - PLAN PREP ENGINEER:
KEN ENG (847) 705-4247

CONTRACT NO. 60G78

STATE OF ILLINOIS
 DEPARTMENT OF TRANSPORTATION
 DIVISION OF HIGHWAYS

SUBMITTED April 14, 2009

Diana M. O'Keefe
 DEPUTY DIRECTOR OF HIGHWAYS, REGION ONE ENGINEER

May 1, 2009
Charles G. Ingersoll
 ENGINEER OF DESIGN AND ENVIRONMENT

May 1, 2009
Christine M. Reed
 DIRECTOR OF HIGHWAYS, CHIEF ENGINEER



Birinder S. Sachdeva April 10, 2009
 BIRINDER S. SACHDEVA, P.E. DATE
 EXPIRES: 11-30-2009

CR & A CHRISTIAN-ROGE & ASSOCIATES, INC.
 ENGINEERS - PLANNERS - SURVEYORS
 211 W. WACKER DRIVE CHICAGO, IL. 60606
 TELEPHONE: 312-372-2023

PRINTED BY THE AUTHORITY OF THE STATE OF ILLINOIS

INDEX OF SHEETS

1	COVER SHEET
2	INDEX OF SHEETS, LIST OF STATE STANDARDS AND GENERAL NOTES
3	SUMMARY OF QUANTITIES
4 - 5	TYPICAL SECTIONS
6 - 10	ROADWAY PLAN
11 - 15	PAVEMENT MARKING PLAN
16	DETAILS FOR FRAMES AND LIDS ADJUSTMENT WITH MILLING
17	PAVEMENT PATCHING FOR HMA SURFACED PAVEMENT
18	CURB OR CURB AND GUTTER REMOVAL AND REPLACEMENT
19	BUTT JOINT AND HMA TAPER DETAILS
20	FREEWAY ENTRANCE AND EXIT RAMP CLOSURE DETAILS
21	TRAFFIC CONTROL AND PROTECTION FOR SIDE ROADS, INTERSECTIONS AND DRIVEWAYS
22	TYPICAL APPLICATIONS RAISED REFLECTIVE PAVEMENT MARKERS (SNOW-PLOW RESISTANT)
23 - 24	MULTI-LANE FREEWAY PAVEMENT MARKING DETAILS
25	DISTRICT ONE TYPICAL PAVEMENT MARKINGS
26	TRAFFIC CONTROL AND PROTECTION AT TURN BAYS (TO REMAIN OPEN TO TRAFFIC)
27	PAVEMENT MARKING LETTERS AND SYMBOLS FOR TRAFFIC STAGING
28	ARTERIAL ROAD INFORMATION SIGN
29	DISTRICT 1 - DETECTOR LOOP INSTALLATION DETAILS FOR ROADWAY RESURFACING

LIST OF STATE STANDARDS

<u>STANDARD NO.</u>	<u>DESCRIPTION</u>
000001-05	STANDARD SYMBOLS, ABBREVIATIONS AND PATTERNS
442201-03	CLASS C AND D PATCHES
604001-03	FRAME AND LIDS, TYPE 1
604006-04	FRAME AND GRATE 3
604091-02	FRAME AND GRATE 24
606001-04	CONCRETE CURB TYPE B AND COMBINATION CONCRETE CURB AND GUTTER
606301-04	PC CONCRETE ISLANDS AND MEDIANS
701601-00	URBAN LANE CLOSURE, MULTILANE, 1W OR 2W WITH NONTRAVERSABLE MEDIAN
701701-00	URBAN LANE CLOSURE, MULTILANE INTERSECTION
701901-01	TRAFFIC CONTROL DEVICES
780001-02	TYPICAL PAVEMENT MARKINGS

GENERAL NOTES

1. BEFORE STARTING ANY EXCAVATION, THE CONTRACTOR SHALL CALL "JULIE" AT (800) 892-0123 OR 811 FOR FIELD LOCATIONS OF BURIED ELECTRIC, TELEPHONE AND GAS FACILITIES. (48 HOUR NOTIFICATION IS REQUIRED)
2. 10 FOOT TRANSITIONS SHALL BE USED TO MATCH PROPOSED CURB AND GUTTER ITEMS OF WORK TO EXISTING CURBS AND GUTTERS AND CONDITIONS IN THE FIELD UNLESS OTHERWISE SHOWN. THE TRANSITIONS SHALL BE PAID FOR AT THE CONTRACT UNIT PRICE FOR THE PROPOSED ITEMS OF WORK SPECIFIED.
3. THE CONTRACTOR SHALL COORDINATE CONSTRUCTION ACTIVITIES WITH UTILITY COMPANIES AND THE VILLAGE OF GURNEE.
4. WHEN ARTIFICIAL LIGHTING IS USED IN NIGHT OPERATIONS, THE CONTRACTOR SHALL EXERCISE THE UTMOST PRECAUTIONS IN PREVENTING ADVERSE VISIBILITY TO THE MOTORING PUBLIC AND ADJOINING RESIDENTIAL AREAS.
5. THE CONTRACTOR WILL NOT BE ALLOWED TO SET UP A YARD OR FIELD OFFICE ON STATE PROPERTY WITHOUT WRITTEN PERMISSION FROM THE DEPARTMENT.
6. SAW CUTTING PRIOR TO ANY REMOVAL ITEMS NOTED ON THE PLANS OR DIRECTED BY THE ENGINEER SHALL BE CONSIDERED INCLUDED IN THE COST OF THE ITEMS BEING REMOVED.
7. DO NOT SCALE PLANS FOR CONSTRUCTION DIMENSIONS.
8. THE CONTRACTOR SHALL USE CARE IN REMOVING OR EXCAVATING NEAR ALL EXISTING ITEMS WHICH WILL REMAIN. ANY DAMAGE DONE TO EXISTING ITEMS BY THE CONTRACTOR SHALL BE REPAIRED AT THE CONTRACTOR'S EXPENSE.
9. WHEN MILLED PAVEMENT IS OPEN TO TRAFFIC, THE MAXIMUM GRADE DIFFERENTIAL BETWEEN PASSES OF THE MILLING MACHINE SHALL NOT EXCEED 1 1/2 INCHES (40mm) WHERE THE SPEED LIMIT IS 40 MPH OR LESS AND 1 INCH WHERE THE SPEED LIMIT IS GREATER THAN 45 MPH. WITH WRITTEN APPROVAL FROM THE ENGINEER, A MAXIMUM GRADE DIFFERENTIAL OF 3 INCHES MAY BE ALLOWED IF THE EDGE OF THE MILLING IS SLOPED A MINIMUM 1:3 (V:H).
10. UNLESS OTHER CONDITIONS WARRANT EXTENDED LANE CLOSURE AS DETERMINED AND APPROVED IN WRITING BY THE ENGINEER OR AS PROVIDED FOR IN THE CONTRACT SPECIFICATIONS, OVERNIGHT CLOSURES SHALL NOT BE ALLOWED FOR REHABILITATION PROJECTS INVOLVING DAYTIME MILLING AND RESURFACING OPERATIONS AND CLASS D PATCHING.
11. PAVEMENT MARKING TAPE, TYPE III SHALL BE USED FOR SHORT TERM PAVEMENT MARKINGS AND TEMPORARY PAVEMENT MARKINGS ON ALL FINAL SURFACES. THE COST OF THE PAVEMENT MARKING TAPE TYPE III SHALL BE INCLUDED IN THE COST OF SHORT TERM PAVEMENT MARKINGS AND TEMPORARY PAVEMENT MARKINGS.
12. THE RESIDENT ENGINEER SHALL CONTACT THE TRAFFIC CONTROL SUPERVISOR AT (847) 705-4470 A MINIMUM OF 72 HOURS PRIOR TO THE PLACEMENT OF ANY TEMPORARY TRAFFIC CONTROL DEVICES.
13. THE CONTRACTOR SHALL CONTACT MR. WALTER CZARNY, THE AREA TRAFFIC FIELD ENGINEER, AT (773) 685-8386 AT LEAST TWO (2) WEEKS PRIOR TO THE PLACEMENT OF PERMANENT PAVEMENT MARKINGS.
14. BUTT JOINTS WILL BE INSTALLED AT THE ENDS OF ALL RESURFACING (WHERE RESURFACING MEETS EXISTING PAVEMENT), IN ACCORDANCE WITH THE "BUTT JOINT AND HMA TAPER DETAILS" INCLUDED IN THE PLANS, UNLESS OTHERWISE SPECIFIED.
15. MATCH EXISTING PAVEMENT MARKINGS AT THE PROJECT AND OMISSION LIMITS.
16. ALL DAMAGE TO EXISTING PAVEMENT MARKINGS OUTSIDE THE REMOVAL LINE SHOWN ON THE PLANS SHALL BE REPLACED AT THE CONTRACTOR'S EXPENSE.
17. PAY ITEM 55039700 - STORM SEWERS TO BE CLEANED - SHALL ONLY BE UTILIZED TO CLEAN STORM SEWER LATERAL PIPES BETWEEN INLETS OR CATCH BASINS AND THE MAIN SEWER.

FILE NAME = D16078-sht-gennote.dgn
PLOT DATE = 4/15/2009



CHRISTIAN-ROGE & ASSOCIATES, INC.
ENGINEERS-PLANNERS-SURVEYORS
211 WEST WACKER DRIVE
CHICAGO, ILLINOIS 60606
PHONE: (312)372-2023 FAX: (312)372-5274

DESIGNED - G.F.L.	REVISED -
DRAWN - B.K.	REVISED -
CHECKED - M.P.	REVISED -
DATE - APRIL 2009	REVISED -

**STATE OF ILLINOIS
DEPARTMENT OF TRANSPORTATION**

**INDEX OF SHEETS, LIST OF STATE STANDARDS AND GENERAL NOTES
IL. RTE. 132**

SCALE: NONE SHEET NO. 1 OF 1 SHEETS STA. 8+00 TO STA. 151+86

F.A.P. RTE.	SECTION	COUNTY	TOTAL SHEETS	SHEET NO.
541	(X-R & T-13-A) RS-1	LAKE	29	2
				CONTRACT NO. 60678

FED. ROAD DIST. NO. 1 ILLINOIS FED. AID PROJECT

SUMMARY OF QUANTITIES			100% STATE	CONSTRUCTION TYPE CODE
CODE NO	ITEM	UNIT	TOTAL QUANTITIES	1000 URBAN
40600200	BITUMINOUS MATERIALS (PRIME COAT)	TON	88	88
40600300	AGGREGATE (PRIME COAT)	TON	463	463
40600400	MIXTURE FOR CRACKS, JOINTS, AND FLANGEWAYS	TON	80	80
40600895	CONSTRUCTING TEST STRIP	EACH	2	2
40600982	HOT-MIX ASPHALT SURFACE REMOVAL - BUTT JOINT	SQ YD	640	640
40601005	HOT-MIX ASPHALT REPLACEMENT OVER PATCHES	TON	333	333
40603595	POLYMERIZED HOT-MIX ASPHALT SURFACE COURSE, MIX "F", N90	TON	11,339	11,339
42001300	PROTECTIVE COAT	SQ YD	1,364	1,364
44000159	HOT-MIX ASPHALT SURFACE REMOVAL, 2 1/2"	SQ YD	115,700	115,700
44000500	COMBINATION CURB AND GUTTER REMOVAL	FOOT	47	47
44001700	COMBINATION CONCRETE CURB AND GUTTER REMOVAL AND REPLACEMENT	FOOT	2,500	2,500
44002214	HOT-MIX ASPHALT REMOVAL OVER PATCHES, 3 1/2"	SQ YD	1,700	1,700
44003800	MEDIAN SURFACE REMOVAL	SQ FT	4,439	4,439
44201753	CLASS D PATCHES, TYPE II, 9 INCH	SQ YD	1,000	1,000
44201757	CLASS D PATCHES, TYPE III, 9 INCH	SQ YD	500	500
44201759	CLASS D PATCHES, TYPE IV, 9 INCH	SQ YD	200	200
55039700	STORM SEWERS TO BE CLEANED	FOOT	1,080	1,080
60252800	CATCH BASINS TO BE RECONSTRUCTED	EACH	2	2
60257900	MANHOLES TO BE RECONSTRUCTED	EACH	2	2
60300305	FRAMES AND LIDS TO BE ADJUSTED	EACH	15	15
60300310	FRAMES AND LIDS TO BE ADJUSTED (SPECIAL)	EACH	9	9
60404300	FRAMES AND GRATES, TYPE 3	EACH	2	2
60404950	FRAMES AND GRATES, TYPE 24	EACH	2	2
60406100	FRAMES AND LIDS, TYPE 1, CLOSED LID	EACH	2	2
60618300	CONCRETE MEDIAN SURFACE, 4 INCH	SQ FT	4,327	4,327
60620000	CONCRETE MEDIAN, TYPE SB-6.24	SQ FT	452	452

SUMMARY OF QUANTITIES			100% STATE	CONSTRUCTION TYPE CODE
CODE NO	ITEM	UNIT	TOTAL QUANTITIES	1000 URBAN
67000400	ENGINEER'S FIELD OFFICE, TYPE A	CAL MO	6	6
67100100	MOBILIZATION	L SUM	1	1
70102630	TRAFFIC CONTROL AND PROTECTION, STANDARD 701601	L SUM	1	1
70102635	TRAFFIC CONTROL AND PROTECTION, STANDARD 701701	L SUM	1	1
70300100	SHORT-TERM PAVEMENT MARKING	FOOT	57,000	57,000
70300210	TEMPORARY PAVEMENT MARKING - LETTERS AND SYMBOLS	SQ FT	2,000	2,000
70300220	TEMPORARY PAVEMENT MARKING - LINE 4"	FOOT	37,000	37,000
70300240	TEMPORARY PAVEMENT MARKING - LINE 6"	FOOT	9,400	9,400
70300250	TEMPORARY PAVEMENT MARKING - LINE 8"	FOOT	1,000	1,000
70300260	TEMPORARY PAVEMENT MARKING - LINE 12"	FOOT	1,800	1,800
70300280	TEMPORARY PAVEMENT MARKING - LINE 24"	FOOT	900	900
70301000	WORK ZONE PAVEMENT MARKING REMOVAL	SQ FT	17,000	17,000
* 78000100	THERMOPLASTIC PAVEMENT MARKING - LETTERS AND SYMBOLS	SQ FT	2,000	2,000
* 78000200	THERMOPLASTIC PAVEMENT MARKING - LINE 4"	FOOT	37,000	37,000
* 78000400	THERMOPLASTIC PAVEMENT MARKING - LINE 6"	FOOT	9,400	9,400
* 78000500	THERMOPLASTIC PAVEMENT MARKING - LINE 8"	FOOT	1,000	1,000
* 78000600	THERMOPLASTIC PAVEMENT MARKING - LINE 12"	FOOT	1,800	1,800
* 78000650	THERMOPLASTIC PAVEMENT MARKING - LINE 24"	FOOT	900	900
* 78100100	RAISED REFLECTIVE PAVEMENT MARKER	EACH	700	700
78300200	RAISED REFLECTIVE PAVEMENT MARKER REMOVAL	EACH	700	700
* 88600600	DETECTOR LOOP REPLACEMENT	FOOT	6,055	6,055
X0322256	TEMPORARY INFORMATION SIGNING	SQ FT	52	52
X4067107	POLYMERIZED LEVELING BINDER (MACHINE METHOD), IL-4.75, N50	TON	4,859	4,859
Z0018500	DRAINAGE STRUCTURES TO BE CLEANED	EACH	128	128

* SPECIALTY ITEM

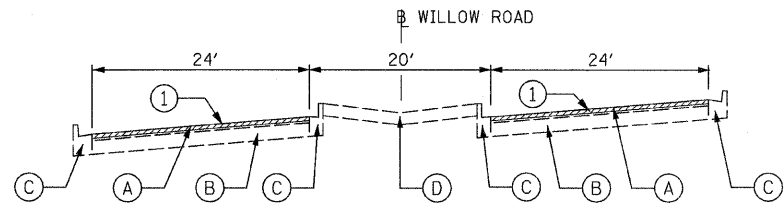

EXISTING TYPICAL SECTION
STA. 8+00 TO STA. 14+62

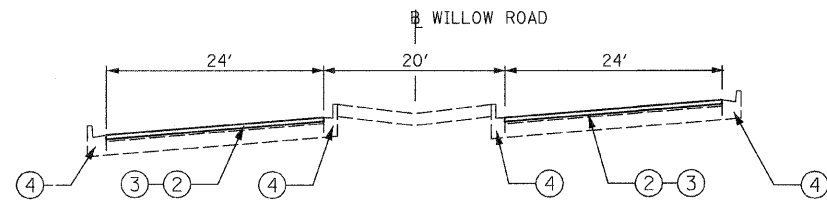

PROPOSED TYPICAL SECTION
STA. 8+00 TO STA. 14+62

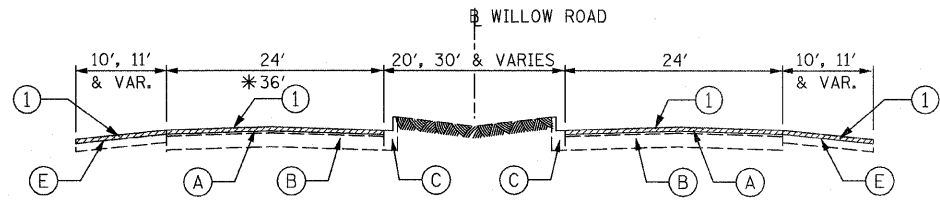

EXISTING TYPICAL SECTION
STA. 14+62 TO STA. 23+25
STA. 27+32 TO STA. 30+90
STA. 46+55 TO STA. 52+00
STA. 55+80 TO STA. 57+40
STA. 64+00 TO STA. 70+30
* STA. 82+90 TO STA. 87+00
* STA. 97+15 TO STA. 107+85

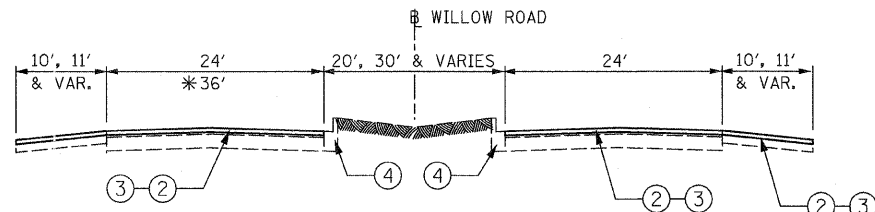

PROPOSED TYPICAL SECTION
STA. 14+62 TO STA. 23+25
STA. 27+32 TO STA. 30+90
STA. 46+55 TO STA. 52+00
STA. 55+80 TO STA. 57+40
STA. 64+00 TO STA. 70+30
* STA. 82+90 TO STA. 87+00
* STA. 97+15 TO STA. 107+85

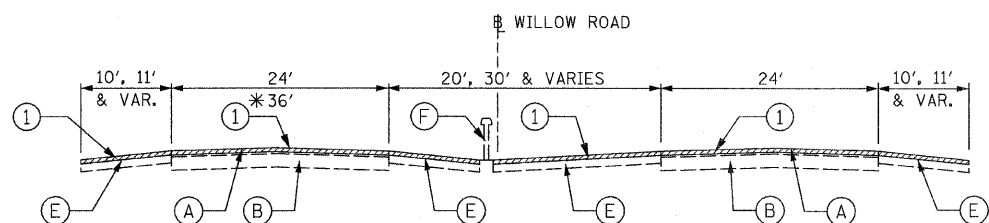

EXISTING TYPICAL SECTION
STA. 23+25 TO STA. 27+32
STA. 41+05 TO STA. 42+45
STA. 52+00 TO STA. 55+80
* STA. 87+00 TO STA. 97+15

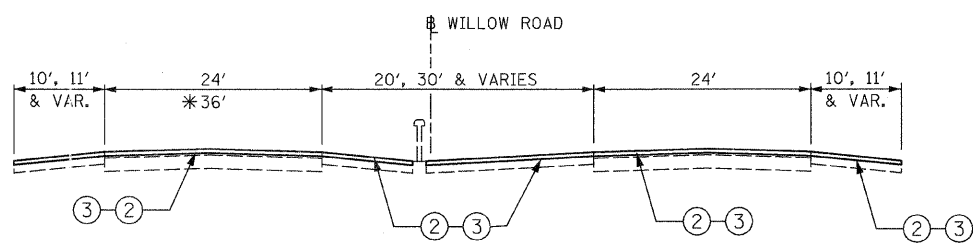

PROPOSED TYPICAL SECTION
STA. 23+25 TO STA. 27+32
STA. 41+05 TO STA. 42+45
STA. 52+00 TO STA. 55+80
* STA. 87+00 TO STA. 97+15

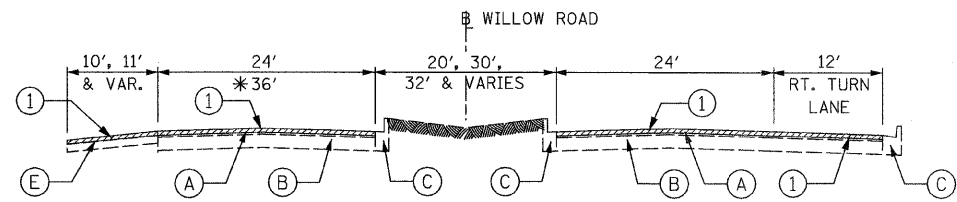

EXISTING TYPICAL SECTION
STA. 30+90 TO STA. 34+00
STA. 44+05 TO STA. 46+55
* STA. 107+85 TO STA. 110+30

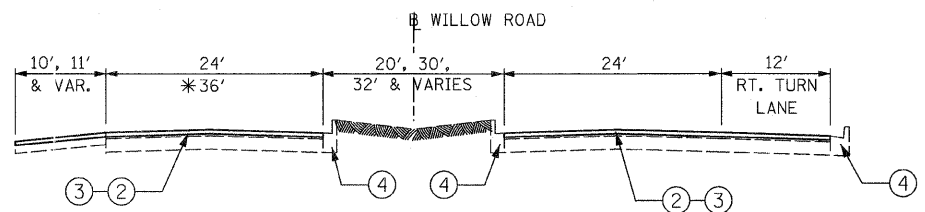

PROPOSED TYPICAL SECTION
STA. 30+90 TO STA. 34+00
STA. 44+05 TO STA. 46+55
* STA. 107+85 TO STA. 110+30

EXISTING CONDITIONS:

- (A) HOT-MIX ASPHALT SURFACE AND BINDER COURSE, 3" & VARIES
- (B) P.C.C. BASE COURSE, 9", P.C.C. PAVEMENT, 10",
HMA PAVEMENT, 12" (FULLDEPTH)
- (C) COMBINATION CONCRETE CURB AND GUTTER, TYPE B-6.24 OR TYPE B-6.12
- (D) CONCRETE MEDIAN, BARRIER, TYPE B-6.24
- (D1) CONCRETE MEDIAN SURFACE, 4" & VARIES
- (E) HMA SHOULDERS / HMA SHOULDERS, FULL DEPTH
- (F) GUARDRAIL

PROPOSED IMPROVEMENTS:

- (1) HOT-MIX ASPHALT SURFACE REMOVAL, 2 1/2"
- (2) POLYMERIZED HOT-MIX ASPHALT SURFACE COURSE, MIX "F", N90, 1 3/4"
- (3) POLYMERIZED LEVELING BINDER (MACHINE METHOD), IL-4.75, N50, 3/4"
- (4) COMB. CONC. CURB AND GUTTER REMOVAL AND REPLACEMENT
(AS DETERMINED BY THE ENGINEER)

NOTE:

CONTRACTOR SHALL PATCH FIRST BEFORE MILLING.

HOT-MIX ASPHALT MIXTURE REQUIREMENTS			
ROADWAY NAME	MIXTURE TYPE	AC TYPE	AIR VOIDS
IL RTE. 132 (GRAND AVE.)	POLYMERIZED HOT-MIX ASPHALT SURFACE COURSE, MIX "F", N90 (IL 9.5 mm)	SBS/SBR PG 70-22	4% @ 90 GYR.
	POLYMERIZED LEVELING BINDER (MACHINE METHOD), IL-4.75, N50	SBS/SBR PG 76-28/-22	4% @ 50 GYR.
	CLASS D PATCHES (HMA BINDER IL-19 mm)	* PG 64-22	4% @ 70 GYR.
	HMA REPLACEMENT OVER PATCHES (HMA BINDER IL-19 mm)	* PG 64-22	4% @ 70 GYR.

THE UNIT WEIGHT USED TO CALCULATE ALL HMA MIXTURE QUANTITIES IS 112 LBS/SQ YD/IN.
* WHEN RAP EXCEEDS 20%, THE NEW ASPHALT BINDER IN THE MIX SHALL BE PG 58-22.

FILE NAME = D160678-sht-typico1.dgn
PLOT DATE = 4/15/2009



DESIGNED - M.P.
DRAWN - B.K.
CHECKED - G.F.L.
DATE - APRIL 2009

REVISED -
REVISED -
REVISED -
REVISED -

STATE OF ILLINOIS
DEPARTMENT OF TRANSPORTATION

TYPICAL SECTIONS
IL RTE. 132

SCALE: NONE SHEET NO. 1 OF 2 SHEETS STA. TO STA.

F.A.P. RTE.	SECTION	COUNTY	TOTAL SHEETS	SHEET NO.
541	(X-R & T-13-A) RS-1	LAKE	29	4
CONTRACT NO. 60678				
FED. ROAD DIST. NO. 1 ILLINOIS FED. AID PROJECT				

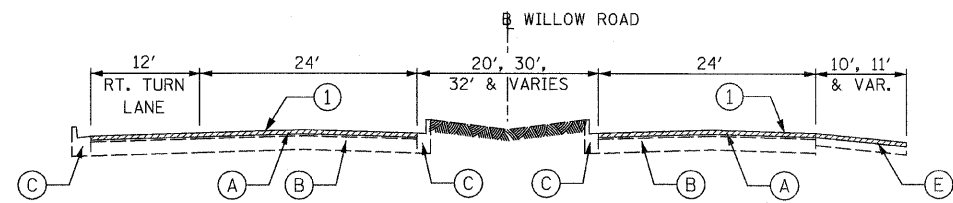

EXISTING TYPICAL SECTION
 STA. 34+00 TO STA. 41+05
 STA. 42+45 TO STA. 44+05

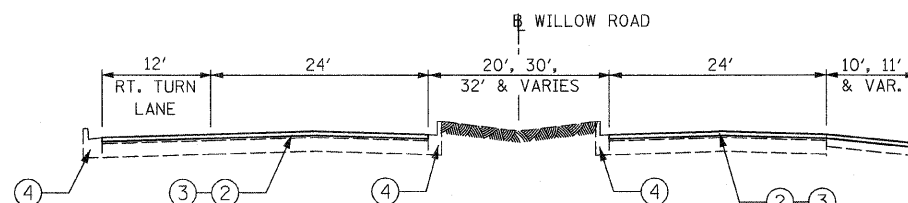

PROPOSED TYPICAL SECTION
 STA. 34+00 TO STA. 41+05
 STA. 42+45 TO STA. 44+05

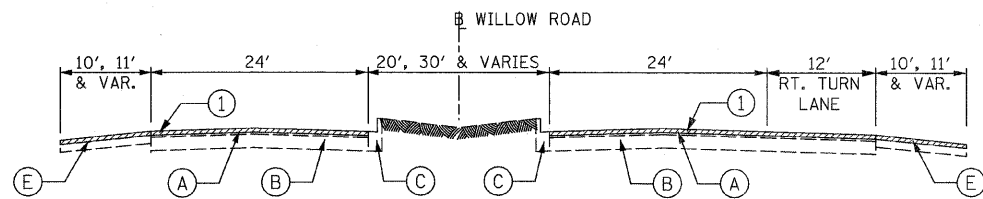

EXISTING TYPICAL SECTION
 STA. 57+40 TO STA. 60+75
 STA. 70+30 TO STA. 73+15

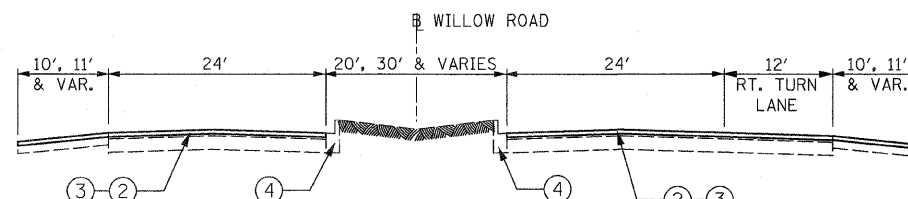

PROPOSED TYPICAL SECTION
 STA. 57+40 TO STA. 60+75
 STA. 70+30 TO STA. 73+15

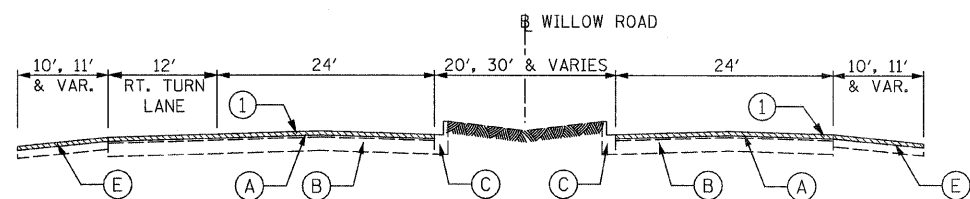

EXISTING TYPICAL SECTION
 STA. 60+75 TO STA. 64+00
 STA. 73+15 TO STA. 82+90

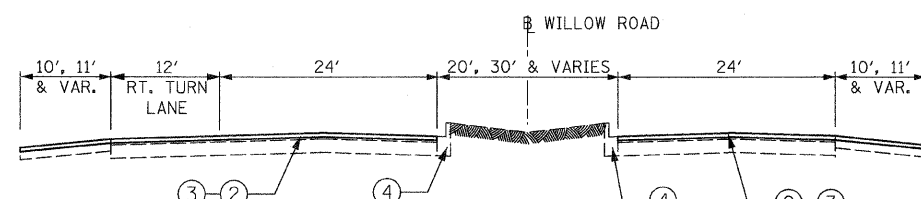

PROPOSED TYPICAL SECTION
 STA. 60+75 TO STA. 64+00
 STA. 73+15 TO STA. 82+90

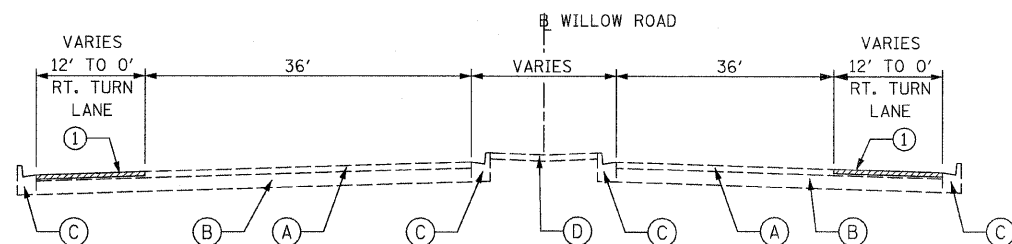

EXISTING TYPICAL SECTION
 STA. 110+30 TO STA. 151+86
 AREA WITH NEW HMA SURFACE
 IN THE THROUGH LANES

RESURFACING ONLY AT LEFT AND RIGHT
 TURN LANES AT LOCATIONS SHOWN ON THE
 PLANS OR AS DIRECTED BY THE ENGINEER.

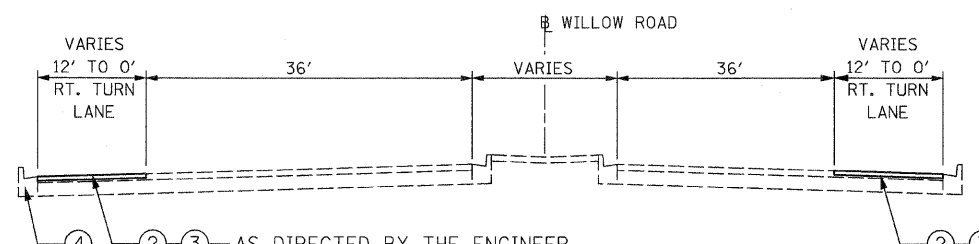

PROPOSED TYPICAL SECTION
 STA. 110+30 TO STA. 151+86
 AREA WITH NEW HMA SURFACE
 IN THE THROUGH LANES

RESURFACING ONLY AT LEFT AND RIGHT
 TURN LANES AT LOCATIONS SHOWN ON THE
 PLANS OR AS DIRECTED BY THE ENGINEER.

EXISTING CONDITIONS:

- (A) HOT-MIX ASPHALT SURFACE AND BINDER COURSE, 3" & VARIES
- (B) P.C.C. BASE COURSE, 9", P.C.C. PAVEMENT, 10",
HMA PAVEMENT, 12" (FULLDEPTH)
- (C) COMBINATION CONCRETE CURB AND GUTTER, TYPE B-6.24 OR TYPE B-6.12
- (D) CONCRETE MEDIAN, BARRIER, TYPE B-6.24
- (DI) CONCRETE MEDIAN SURFACE, 4" & VARIES
- (E) HMA SHOULDERS / HMA SHOULDERS, FULL DEPTH
- (F) GUARDRAIL

PROPOSED IMPROVEMENTS:

- (1) HOT-MIX ASPHALT SURFACE REMOVAL, 2 1/2"
- (2) POLYMERIZED HOT-MIX ASPHALT SURFACE COURSE, MIX "F", N90, 1 3/4"
- (3) POLYMERIZED LEVELING BINDER (MACHINE METHOD), IL-4.75, N50, 3/4"
- (4) COMB. CONC. CURB AND GUTTER REMOVAL AND REPLACEMENT
(AS DETERMINED BY THE ENGINEER)

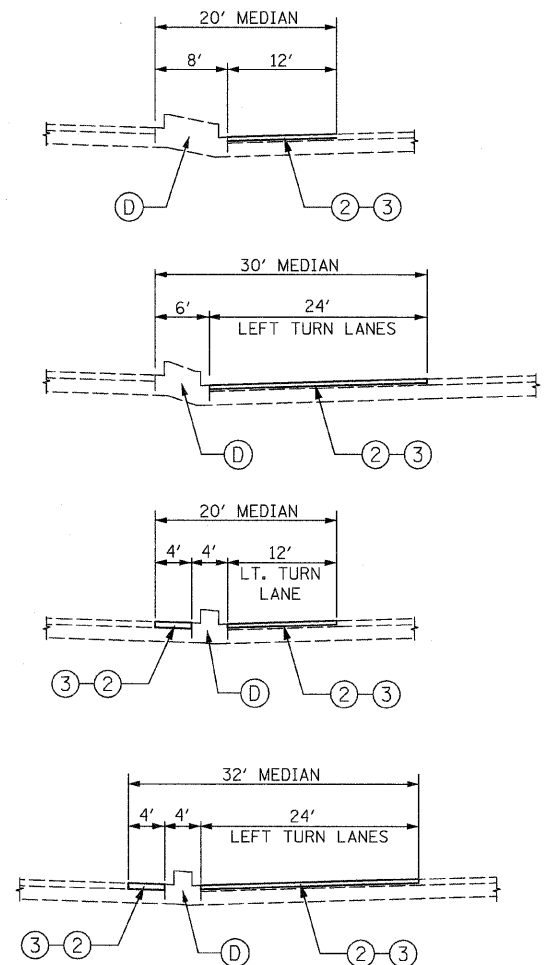

PROPOSED TYPICAL SECTION
 LEFT TURN LANE MEDIAN DETAILS

FILE NAME = D160678-sh-typical.dgn
 PLOT DATE = 4/15/2009

CHRISTIAN-ROGE & ASSOCIATES, INC.
 ENGINEERS-PLANNERS-SURVEYORS
 211 WEST WACKER DRIVE
 CHICAGO, ILLINOIS 60606
 PHONE: (312)372-2023 FAX: (312)372-5274

DESIGNED - M.P.
 DRAWN - B.K.
 CHECKED - G.F.L.
 DATE - APRIL 2009

REVISED -
 REVISED -
 REVISED -
 REVISED -

STATE OF ILLINOIS
DEPARTMENT OF TRANSPORTATION

TYPICAL SECTIONS
IL. RTE. 132

SCALE: NONE SHEET NO. 2 OF 2 SHEETS STA. TO STA.

F.A.P. RTE.	SECTION	COUNTY	TOTAL SHEETS	SHEET NO.
541	(X-R & T-13-A) RS-1	LAKE	29	5
CONTRACT NO. 60678				
FED. ROAD DIST. NO. 1 ILLINOIS FED. AID PROJECT				

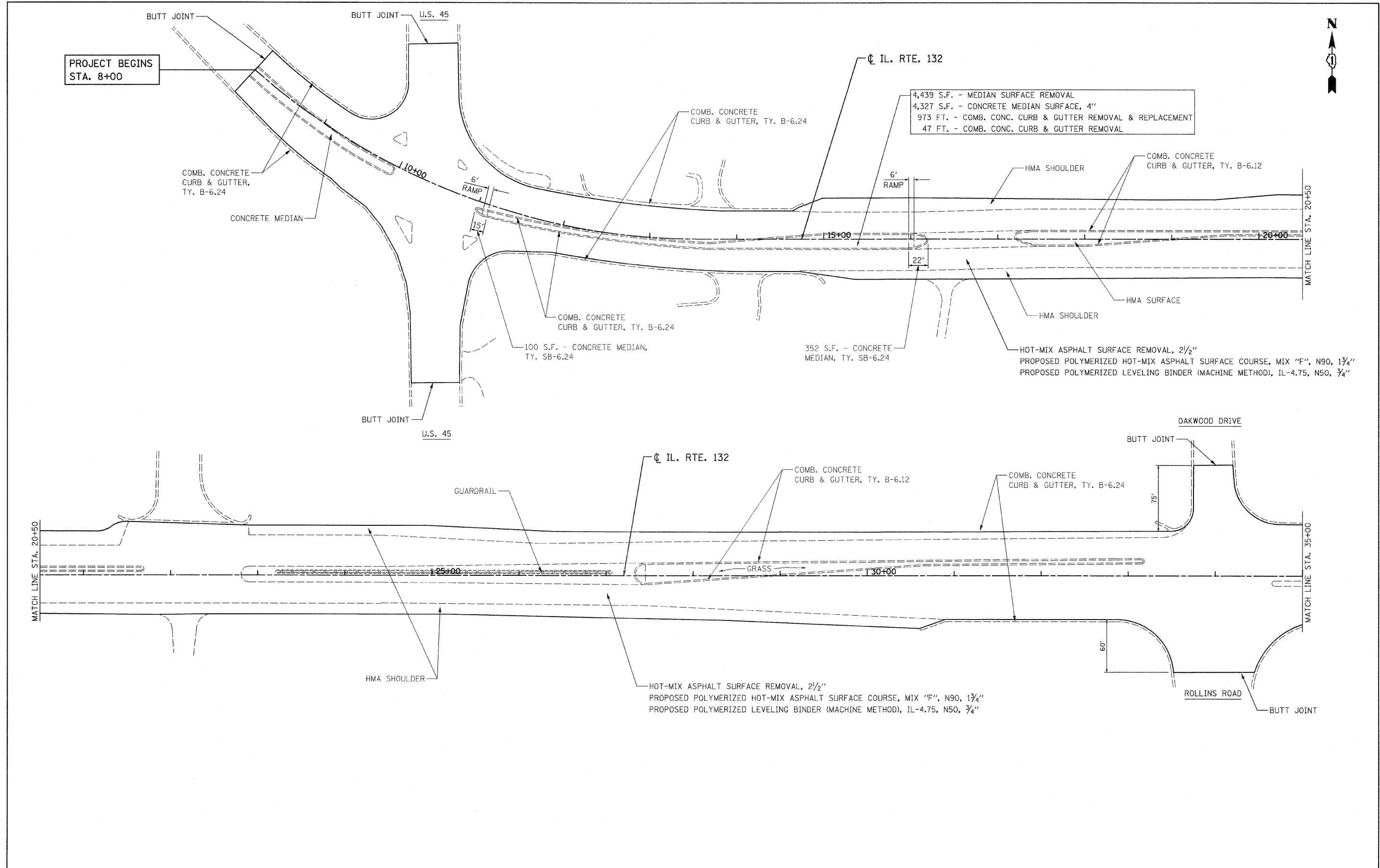

FILE NAME = D160G78-ah-plot.dgn
PLOT DATE = 4/15/2009

CHRISTIAN-ROGE & ASSOCIATES, INC.
ENGINEERS-PLANNERS-SURVEYORS
211 WEST WACKER DRIVE
CHICAGO, ILLINOIS 60606
PHONE: (312)372-2023 FAX: (312)372-5274

DESIGNED - M.P.	REVISED -
DRAWN - B.K.	REVISED -
CHECKED - G.F.L.	REVISED -
DATE - APRIL 2009	REVISED -

**STATE OF ILLINOIS
DEPARTMENT OF TRANSPORTATION**

**ROADWAY PLAN
IL. RTE. 132**

SCALE: 1" = 50' SHEET NO. 1 OF 5 SHEETS STA. 8+00 TO STA. 35+00

F.A.P. RTE.	SECTION	COUNTY	TOTAL SHEETS	SHEET NO.
541	(X-R & T-13-A) RS-1	LAKE	29	6
CONTRACT NO. 60G78				
FED. ROAD DIST. NO. 1 ILLINOIS FED. AID PROJECT				

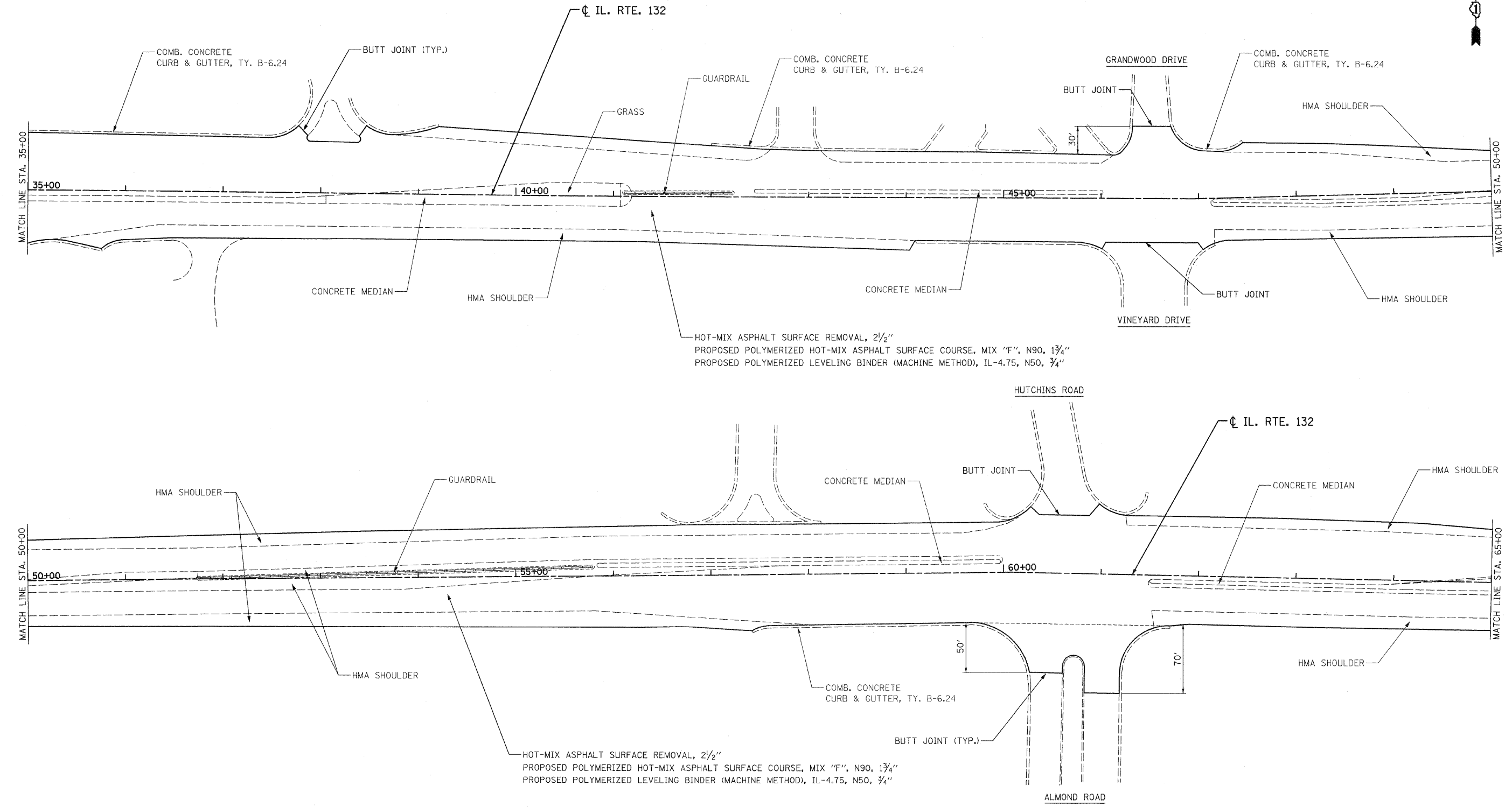
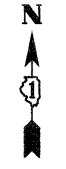

FILE NAME = D:\68078-sh1-plan2.dgn
 PLOT DATE = 4/15/2009

CHRISTIAN-ROGE & ASSOCIATES, INC.
 ENGINEERS-PLANNERS-SURVEYORS
 211 WEST WACKER DRIVE
 CHICAGO, ILLINOIS 60606
 PHONE: (312)372-2023 FAX: (312)372-5274

DESIGNED - M.P.
 DRAWN - B.K.
 CHECKED - G.F.L.
 DATE - APRIL 2009

REVISED -
 REVISED -
 REVISED -
 REVISED -

STATE OF ILLINOIS
DEPARTMENT OF TRANSPORTATION

ROADWAY PLAN
IL. RTE. 132
 SCALE: 1" = 50' SHEET NO. 2 OF 5 SHEETS STA. 35+00 TO STA. 65+00

F.A.P. RTE.	SECTION	COUNTY	TOTAL SHEETS	SHEET NO.
541	(X-R & T-13-A) RS-1	LAKE	29	7
CONTRACT NO. 60G78				
FED. ROAD DIST. NO. 1 ILLINOIS FED. AID PROJECT				

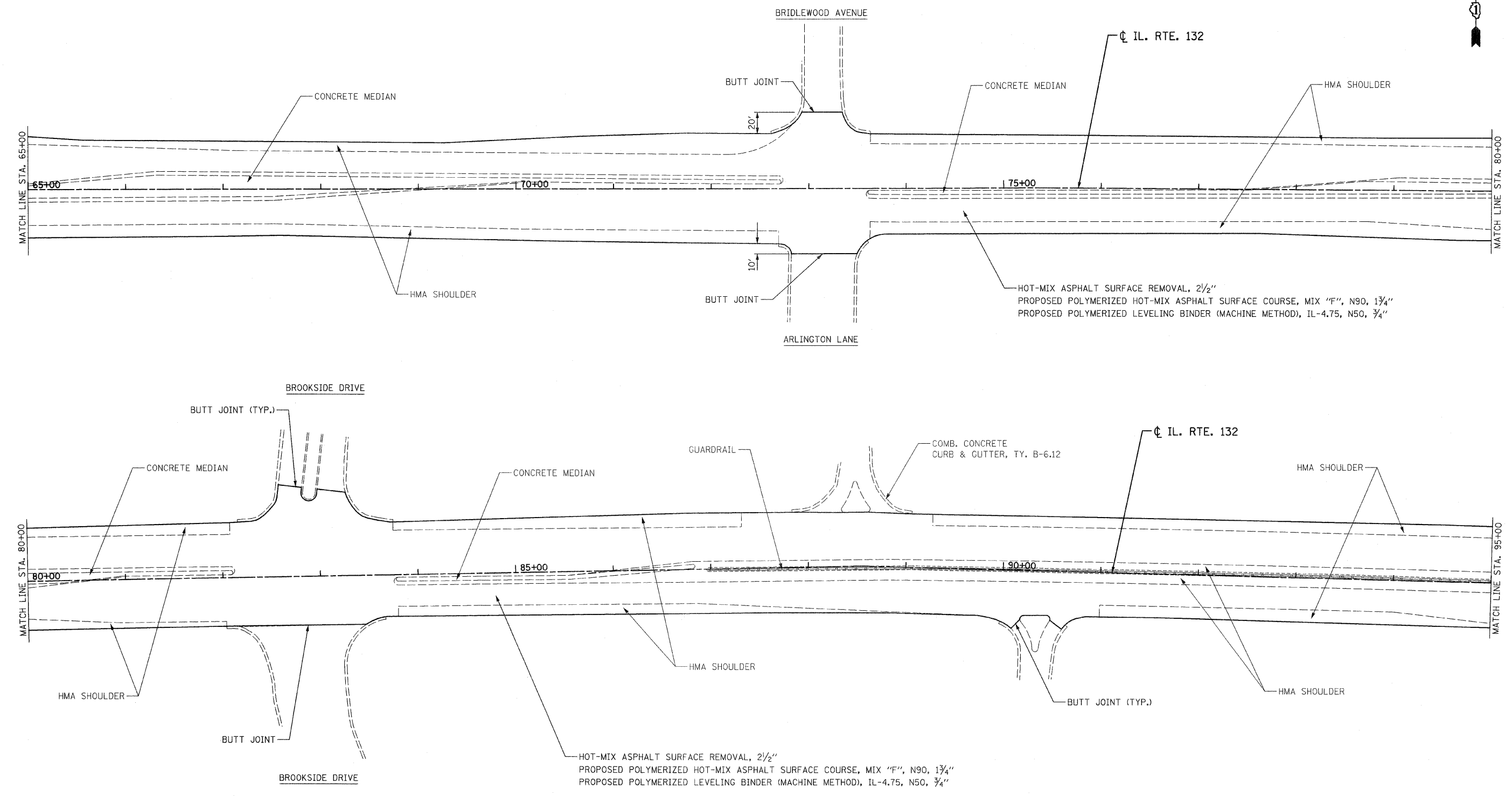

FILE NAME = D168678-sh1-plan3.dgn
 PLOT DATE = 4/15/2009

CHRISTIAN-ROGE & ASSOCIATES, INC.
 ENGINEERS-PLANNERS-SURVEYORS
 211 WEST WACKER DRIVE
 CHICAGO, ILLINOIS 60606
 PHONE: (312)372-2023 FAX: (312)372-5274

DESIGNED - M.P.	REVISED -
DRAWN - B.K.	REVISED -
CHECKED - G.F.L.	REVISED -
DATE - APRIL 2009	REVISED -

**STATE OF ILLINOIS
 DEPARTMENT OF TRANSPORTATION**

**ROADWAY PLAN
 IL. RTE. 132**

SCALE: 1" = 50' SHEET NO. 3 OF 5 SHEETS STA. 65+00 TO STA. 95+00

F.A.P. RTE. 541	SECTION (X-R & T-13-A) RS-1	COUNTY LAKE	TOTAL SHEETS 29	SHEET NO. 8
CONTRACT NO. 60G78				
FED. ROAD DIST. NO. 1 ILLINOIS FED. AID PROJECT				

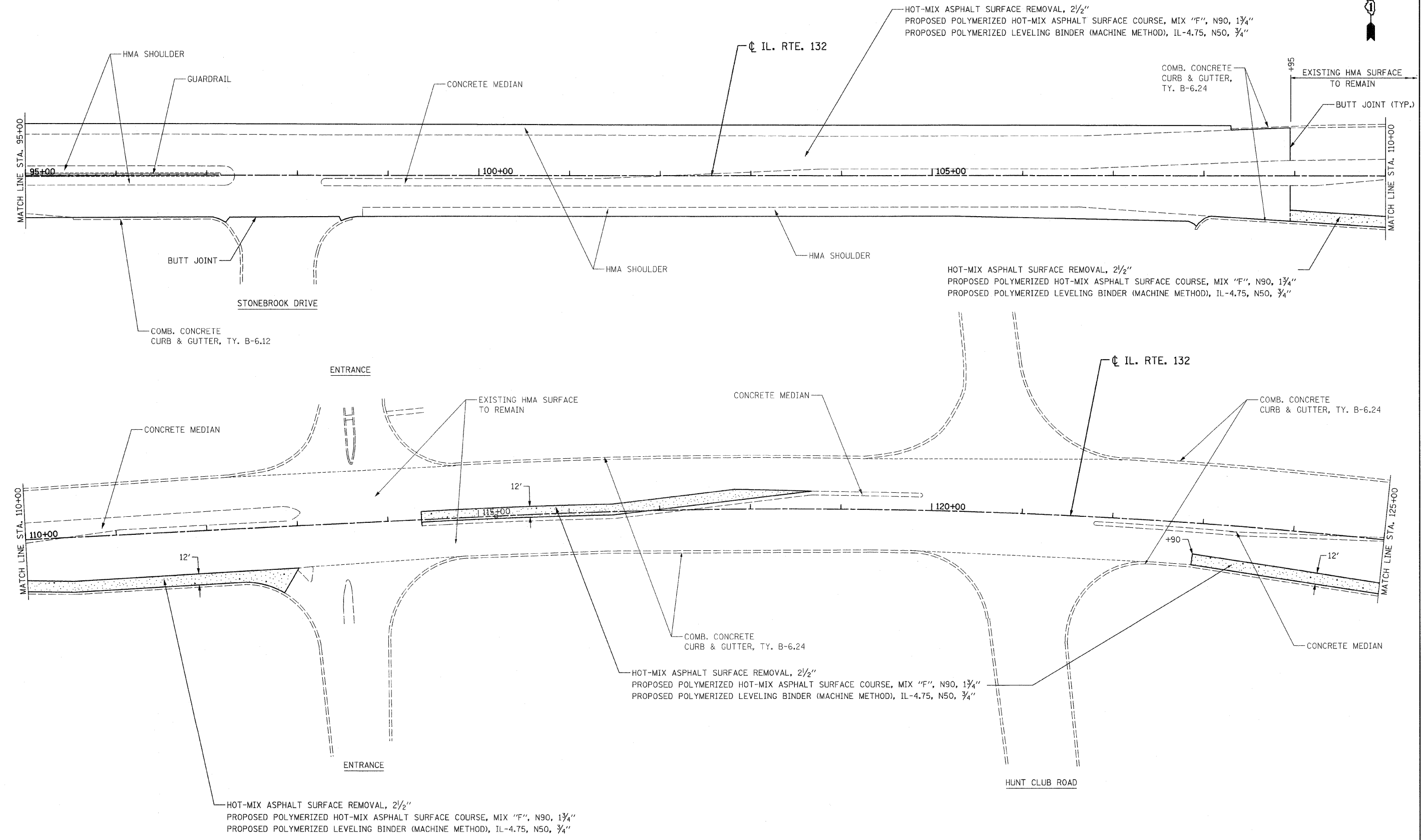

FILE NAME = D168078-wt-plan4.dgn
 PLOT DATE = 4/15/2009



CHRISTIAN-ROGE & ASSOCIATES, INC.
 ENGINEERS-PLANNERS-SURVEYORS
 211 WEST WACKER DRIVE
 CHICAGO, ILLINOIS 60606
 PHONE: (312)372-2023 FAX: (312)372-5274

DESIGNED - M.P.	REVISED -
DRAWN - B.K.	REVISED -
CHECKED - G.F.L.	REVISED -
DATE - APRIL 2009	REVISED -

STATE OF ILLINOIS
DEPARTMENT OF TRANSPORTATION

ROADWAY PLAN
IL. RTE. 132
 SCALE: 1" = 50' SHEET NO. 4 OF 5 SHEETS STA. 95+00 TO STA. 125+00

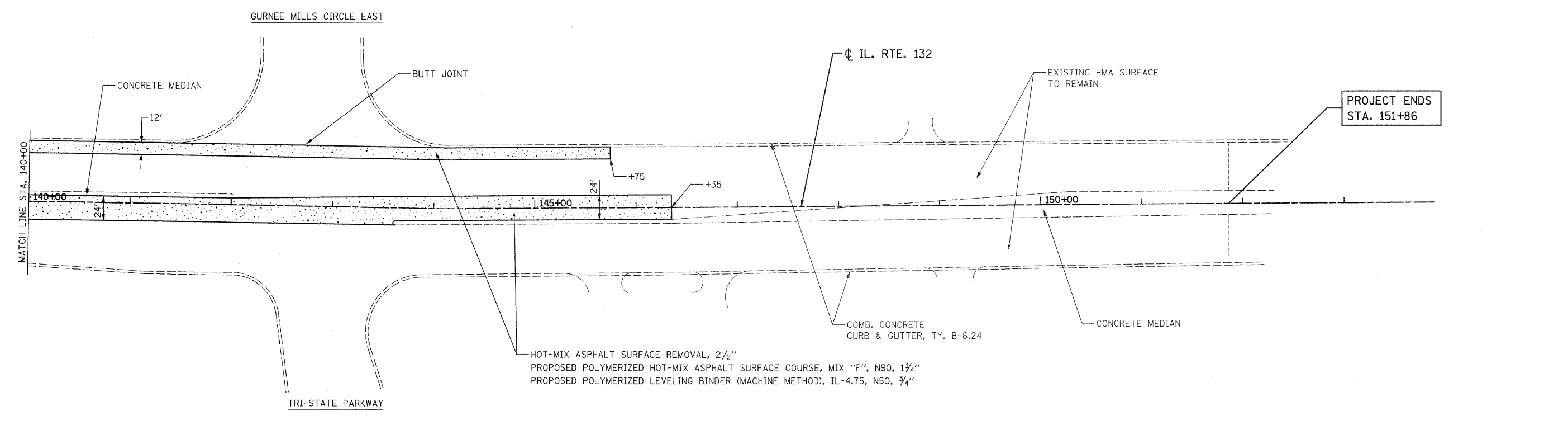
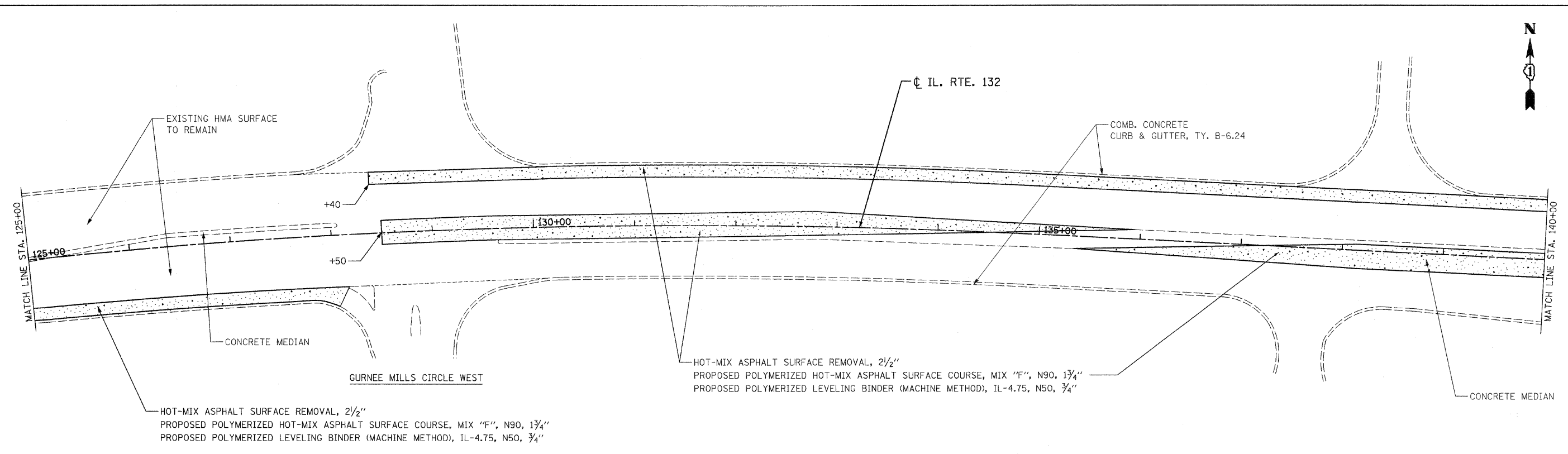
F.A.P. RTE. 541	SECTION (X-R & T-13-A) RS-1	COUNTY LAKE	TOTAL SHEETS 29	SHEET NO. 9
CONTRACT NO. 60G78				
FED. ROAD DIST. NO. 1 ILLINOIS FED. AID PROJECT				



FILE NAME = D160678-shr-plan5.dgn
 PLOT DATE = 4/15/2009

CHRISTIAN-ROGE & ASSOCIATES, INC.
 ENGINEERS-PLANNERS-SURVEYORS
 211 WEST WACKER DRIVE
 CHICAGO, ILLINOIS 60606
 PHONE: (312)372-2023 FAX: (312)372-5274

DESIGNED - M.P.	REVISED -
DRAWN - B.K.	REVISED -
CHECKED - G.F.L.	REVISED -
DATE - APRIL 2009	REVISED -

**STATE OF ILLINOIS
 DEPARTMENT OF TRANSPORTATION**

**ROADWAY PLAN
 IL. RTE. 132**

SCALE: 1" = 50' SHEET NO. 5 OF 5 SHEETS STA. 125+00 TO STA. 151+86

F.A.P. RTE.	SECTION	COUNTY	TOTAL SHEETS	SHEET NO.
541	(X-R & T-13-A) RS-1	LAKE	29	10
CONTRACT NO. 60G78				
FED. ROAD DIST. NO. 1 ILLINOIS FED. AID PROJECT				



PROJECT BEGINS
STA. 8+00
MATCH EXISTING
PAVEMENT MARKINGS

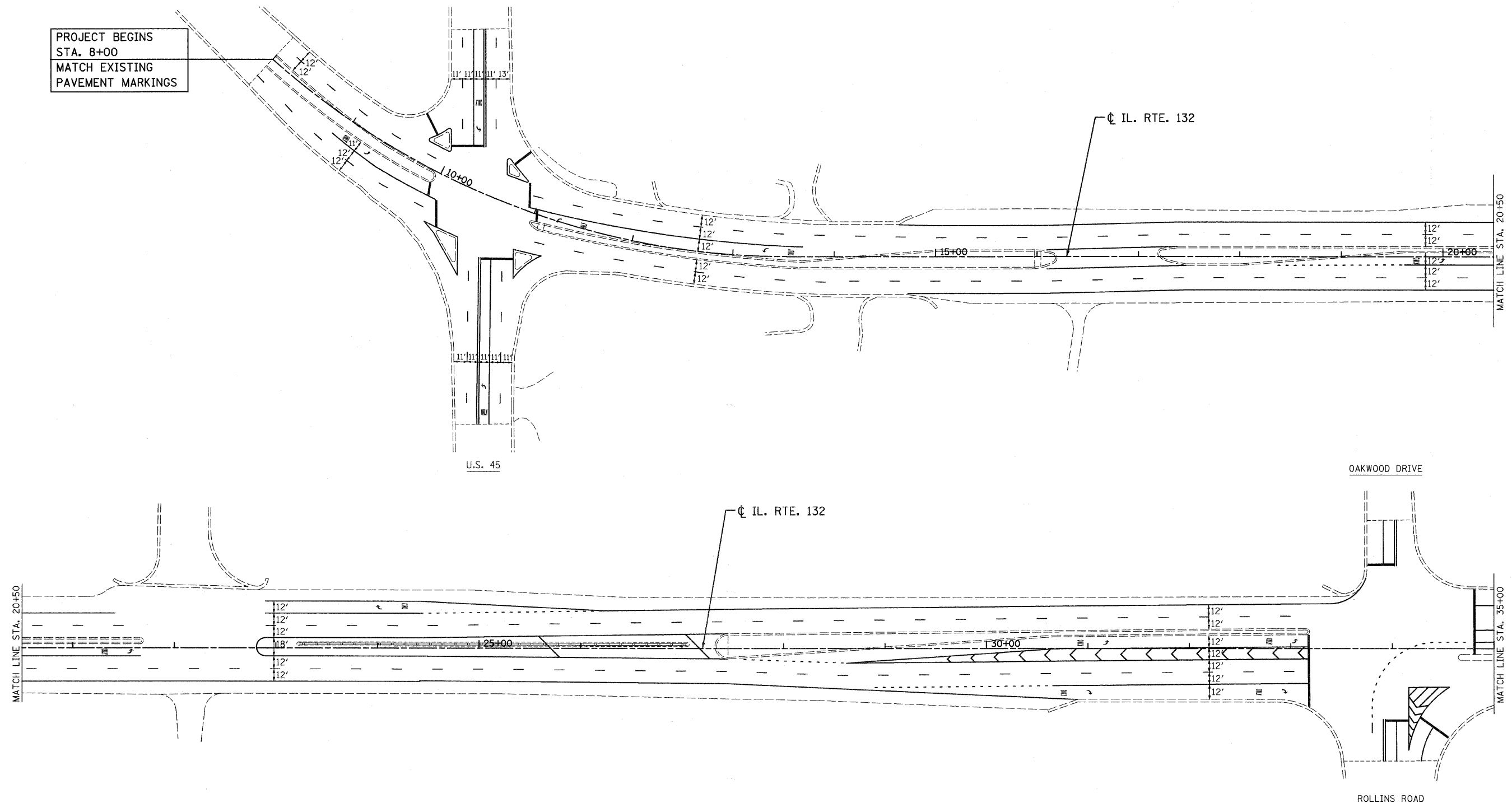

LEGEND			
1	LINE 4" (YELLOW SOLID LINE)	5	LINE 4" (WHITE SOLID LINE)
2	LINE 4" (DOUBLE YELLOW SOLID LINES)	6	LINE 6" (WHITE SOLID LINE)
3	LINE 4" (YELLOW - 10' DASH, 30' SKIP)	7	LINE 6" (WHITE LANE LINE - 2' DASH, 6' SKIP)
4	LINE 4" (WHITE LANE LINE - 10' DASH, 30' SKIP)	8	LINE 8" (WHITE SOLID LINE)
		9	LINE 12" (WHITE SOLID LINE)
		10	LINE 12" (WHITE DIAGONAL LINE)
		11	LINE 12" (YELLOW DIAGONAL LINE)
		12	LINE 24" (WHITE STOP BAR)
		13	LETTERS AND SYMBOLS (TYP.)

NOTES:

1. ALL PAVEMENT MARKINGS SHALL BE THERMOPLASTIC UNLESS OTHERWISE SPECIFIED.
2. RAISED REFLECTIVE PAVEMENT MARKERS SHALL BE USED THROUGHOUT THE PROJECT LIMITS. SEE DISTRICT DETAIL TC-11.

FILE NAME = D160678-sh-t-pmk1.dgn
PLOT DATE = 4/15/2009

CHRISTIAN-ROGE & ASSOCIATES, INC.
ENGINEERS-PLANNERS-SURVEYORS
211 WEST WACKER DRIVE
CHICAGO, ILLINOIS 60606
PHONE: (312)372-2923 FAX: (312)372-5274

DESIGNED - M.P.	REVISED -
DRAWN - B.K.	REVISED -
CHECKED - G.F.L.	REVISED -
DATE - APRIL 2009	REVISED -

**STATE OF ILLINOIS
DEPARTMENT OF TRANSPORTATION**

**PAVEMENT MARKING PLAN
IL. RTE. 132**

SCALE: 1" = 50' SHEET NO. 1 OF 5 SHEETS STA. 8+00 TO STA. 35+00

F.A.P. RTE.	SECTION	COUNTY	TOTAL SHEETS	SHEET NO.
541	(X-R & T-13-A) RS-1	LAKE	29	11
FED. ROAD DIST. NO. 1 ILLINOIS FED. AID PROJECT				
CONTRACT NO. 60G78				

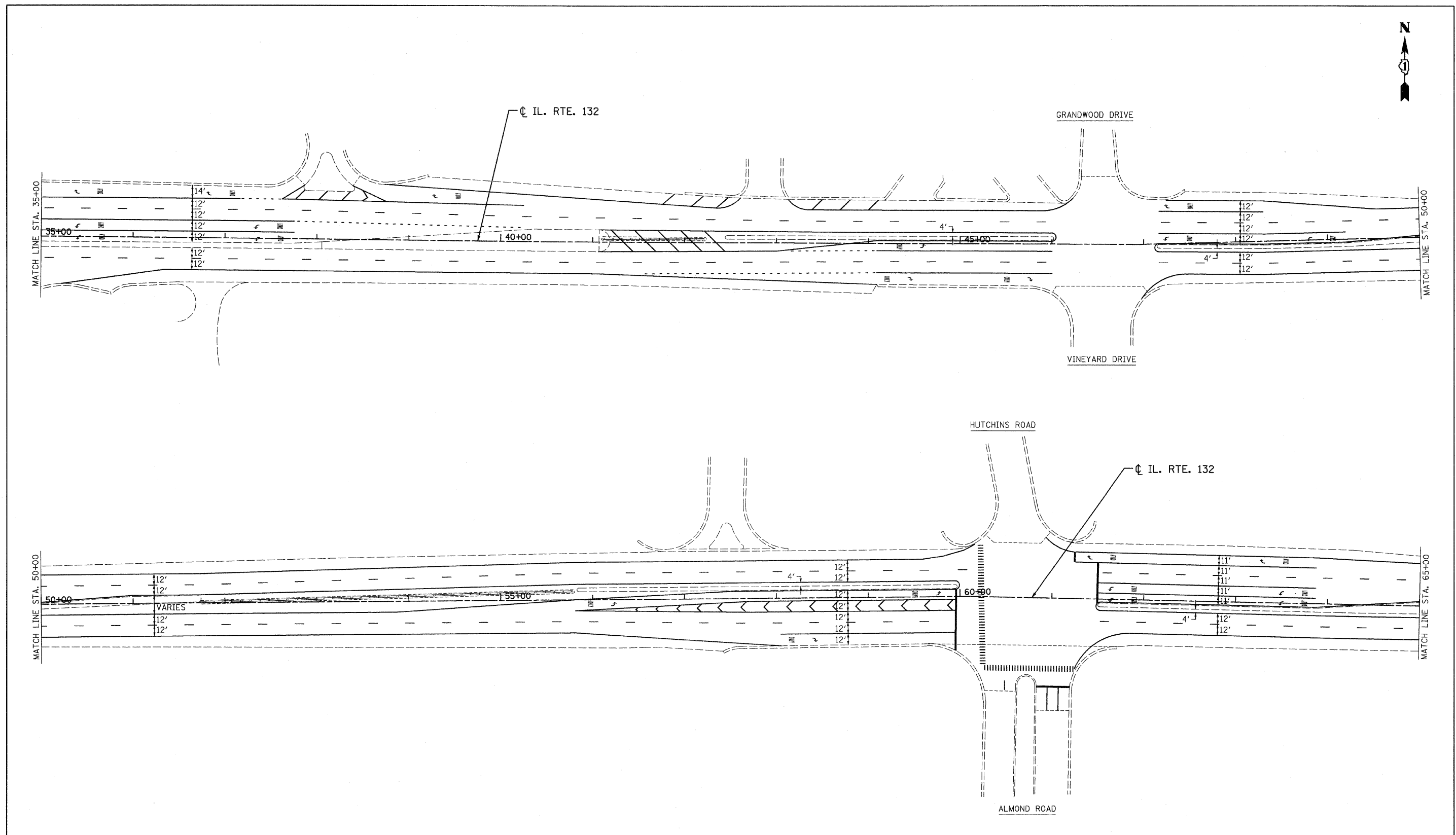

LEGEND			
1	LINE 4" (YELLOW SOLID LINE)	5	LINE 4" (WHITE SOLID LINE)
2	LINE 4" (DOUBLE YELLOW SOLID LINES)	6	LINE 6" (WHITE SOLID LINE)
3	LINE 4" (YELLOW - 10' DASH, 30' SKIP)	7	LINE 6" (WHITE LANE LINE - 2' DASH, 6' SKIP)
4	LINE 4" (WHITE LANE LINE - 10' DASH, 30' SKIP)	8	LINE 8" (WHITE SOLID LINE)
		9	LINE 12" (WHITE SOLID LINE)
		10	LINE 12" (WHITE DIAGONAL LINE)
		11	LINE 12" (YELLOW DIAGONAL LINE)
		12	LINE 24" (WHITE STOP BAR)
		13	LETTERS AND SYMBOLS (TYP.)

NOTES:

1. ALL PAVEMENT MARKINGS SHALL BE THERMOPLASTIC UNLESS OTHERWISE SPECIFIED.
2. RAISED REFLECTIVE PAVEMENT MARKERS SHALL BE USED THROUGHOUT THE PROJECT LIMITS. SEE DISTRICT DETAIL TC-11.

FILE NAME = D160678-ah-t-pmk2.dgn
 PLOT DATE = 4/15/2009

CHRISTIAN-ROGE & ASSOCIATES, INC.
 ENGINEERS-PLANNERS-SURVEYORS
 211 WEST WACKER DRIVE
 CHICAGO, ILLINOIS 60606
 PHONE: (312)372-2023 FAX: (312)372-5274

DESIGNED - M.P.	REVISED -
DRAWN - B.K.	REVISED -
CHECKED - G.F.L.	REVISED -
DATE - APRIL 2009	REVISED -

**STATE OF ILLINOIS
 DEPARTMENT OF TRANSPORTATION**

**PAVEMENT MARKING PLAN
 IL. RTE. 132**

SCALE: 1" = 50' SHEET NO. 2 OF 5 SHEETS STA. 35+00 TO STA. 65+00

F.A.P. RTE.	SECTION	COUNTY	TOTAL SHEETS	SHEET NO.
541	(X-R & T-13-A) RS-1	LAKE	29	12
CONTRACT NO. 60G78				
FED. ROAD DIST. NO. 1 ILLINOIS FED. AID PROJECT				

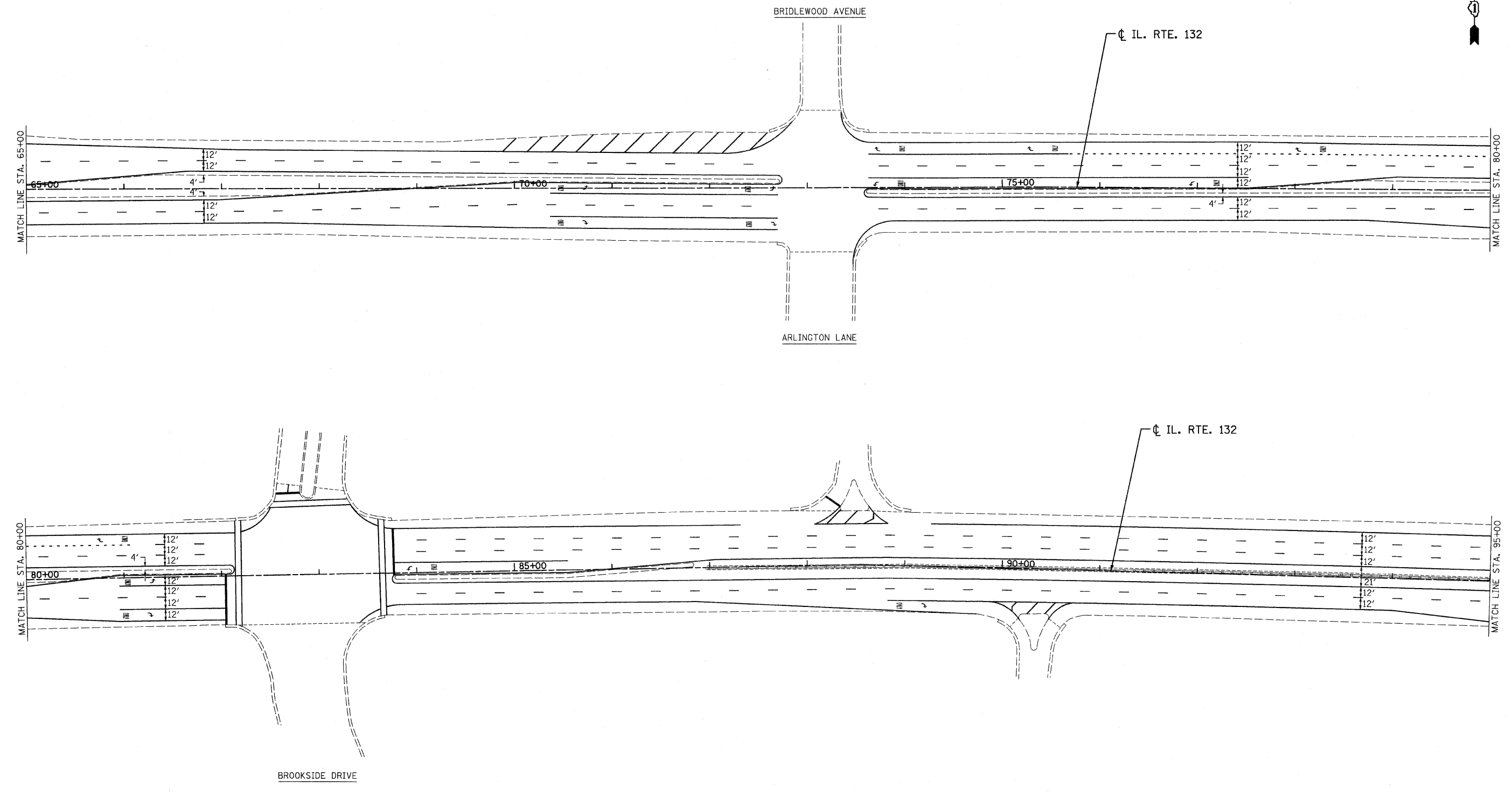

- LEGEND**
- 1 LINE 4" (YELLOW SOLID LINE)
 - 2 LINE 4" (DOUBLE YELLOW SOLID LINES)
 - 3 LINE 4" (YELLOW - 10' DASH, 30' SKIP)
 - 4 LINE 4" (WHITE LANE LINE - 10' DASH, 30' SKIP)
 - 5 LINE 4" (WHITE SOLID LINE)
 - 6 LINE 6" (WHITE SOLID LINE)
 - 7 LINE 6" (WHITE LANE LINE - 2' DASH, 6' SKIP)
 - 8 LINE 8" (WHITE SOLID LINE)
 - 9 LINE 12" (WHITE SOLID LINE)
 - 10 LINE 12" (WHITE DIAGONAL LINE)
 - 11 LINE 12" (YELLOW DIAGONAL LINE)
 - 12 LINE 24" (WHITE STOP BAR)
 - 13 LETTERS AND SYMBOLS (TYP.)

- NOTES:**
1. ALL PAVEMENT MARKINGS SHALL BE THERMOPLASTIC UNLESS OTHERWISE SPECIFIED.
 2. RAISED REFLECTIVE PAVEMENT MARKERS SHALL BE USED THROUGHOUT THE PROJECT LIMITS. SEE DISTRICT DETAIL TC-11.

FILE NAME = D160678-shr-pmk3.dgn
 PLOT DATE = 4/15/2009



DESIGNED - M.P.	REVISED -
DRAWN - B.K.	REVISED -
CHECKED - G.F.L.	REVISED -
DATE - APRIL 2009	REVISED -

**STATE OF ILLINOIS
 DEPARTMENT OF TRANSPORTATION**

**PAVEMENT MARKING PLAN
 IL. RTE. 132**

SCALE: 1" = 50' SHEET NO. 3 OF 5 SHEETS STA. 65+00 TO STA. 95+00

F.A.P. RTE.	SECTION	COUNTY	TOTAL SHEETS	SHEET NO.
541	(X-R & T-13-A) RS-1	LAKE	29	13
CONTRACT NO. 60678				
<small>FED. ROAD DIST. NO. 1 ILLINOIS FED. AID PROJECT</small>				

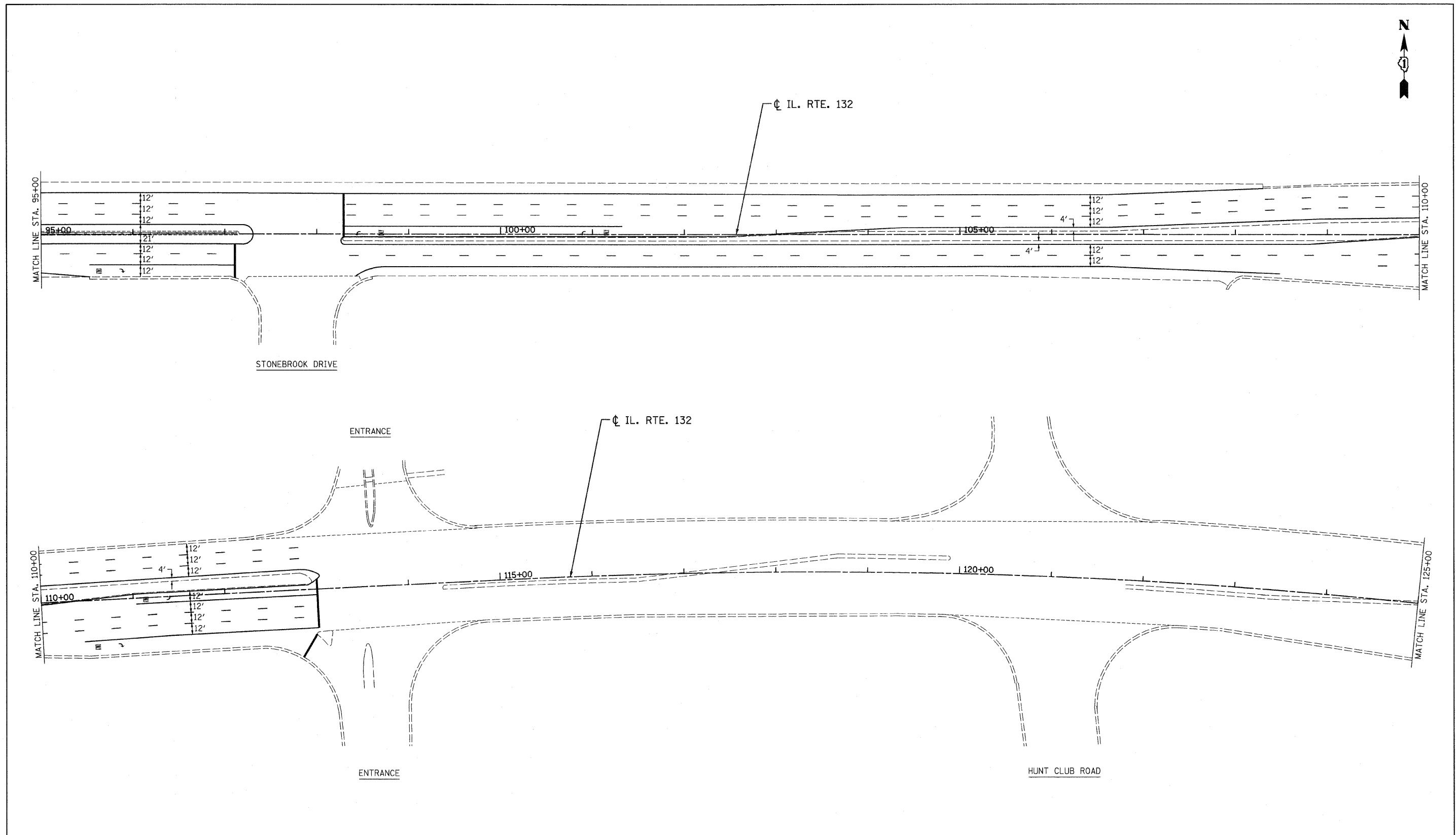

LEGEND			
1	LINE 4" (YELLOW SOLID LINE)	5	LINE 4" (WHITE SOLID LINE)
2	LINE 4" (DOUBLE YELLOW SOLID LINES)	6	LINE 6" (WHITE SOLID LINE)
3	LINE 4" (YELLOW - 10' DASH, 30' SKIP)	7	LINE 6" (WHITE LANE LINE - 2' DASH, 6' SKIP)
4	LINE 4" (WHITE LANE LINE - 10' DASH, 30' SKIP)	8	LINE 8" (WHITE SOLID LINE)
		9	LINE 12" (WHITE SOLID LINE)
		10	LINE 12" (WHITE DIAGONAL LINE)
		11	LINE 12" (YELLOW DIAGONAL LINE)
		12	LINE 24" (WHITE STOP BAR)
		13	LETTERS AND SYMBOLS (TYP.)

NOTES:

1. ALL PAVEMENT MARKINGS SHALL BE THERMOPLASTIC UNLESS OTHERWISE SPECIFIED.
2. RAISED REFLECTIVE PAVEMENT MARKERS SHALL BE USED THROUGHOUT THE PROJECT LIMITS. SEE DISTRICT DETAIL TC-11.

FILE NAME = D160678-sh1-pmk4.dgn
 PLOT DATE = 4/15/2009

CHRISTIAN-ROGE & ASSOCIATES, INC.
 ENGINEERS-PLANNERS-SURVEYORS
 211 WEST WACKER DRIVE
 CHICAGO, ILLINOIS 60606
 PHONE: (312)372-2023 FAX: (312)372-5274

DESIGNED - M.P.	REVISED -
DRAWN - B.K.	REVISED -
CHECKED - G.F.L.	REVISED -
DATE - APRIL 2009	REVISED -

STATE OF ILLINOIS
DEPARTMENT OF TRANSPORTATION

PAVEMENT MARKING PLAN
IL. RTE. 132

SCALE: 1" = 50' SHEET NO. 4 OF 5 SHEETS STA. 95+00 TO STA. 125+00

F.A.P. RTE.	SECTION	COUNTY	TOTAL SHEETS	SHEET NO.
541	(X-R & T-13-A) RS-1	LAKE	29	14
FED. ROAD DIST. NO. 1 ILLINOIS FED. AID PROJECT			CONTRACT NO. 60G78	

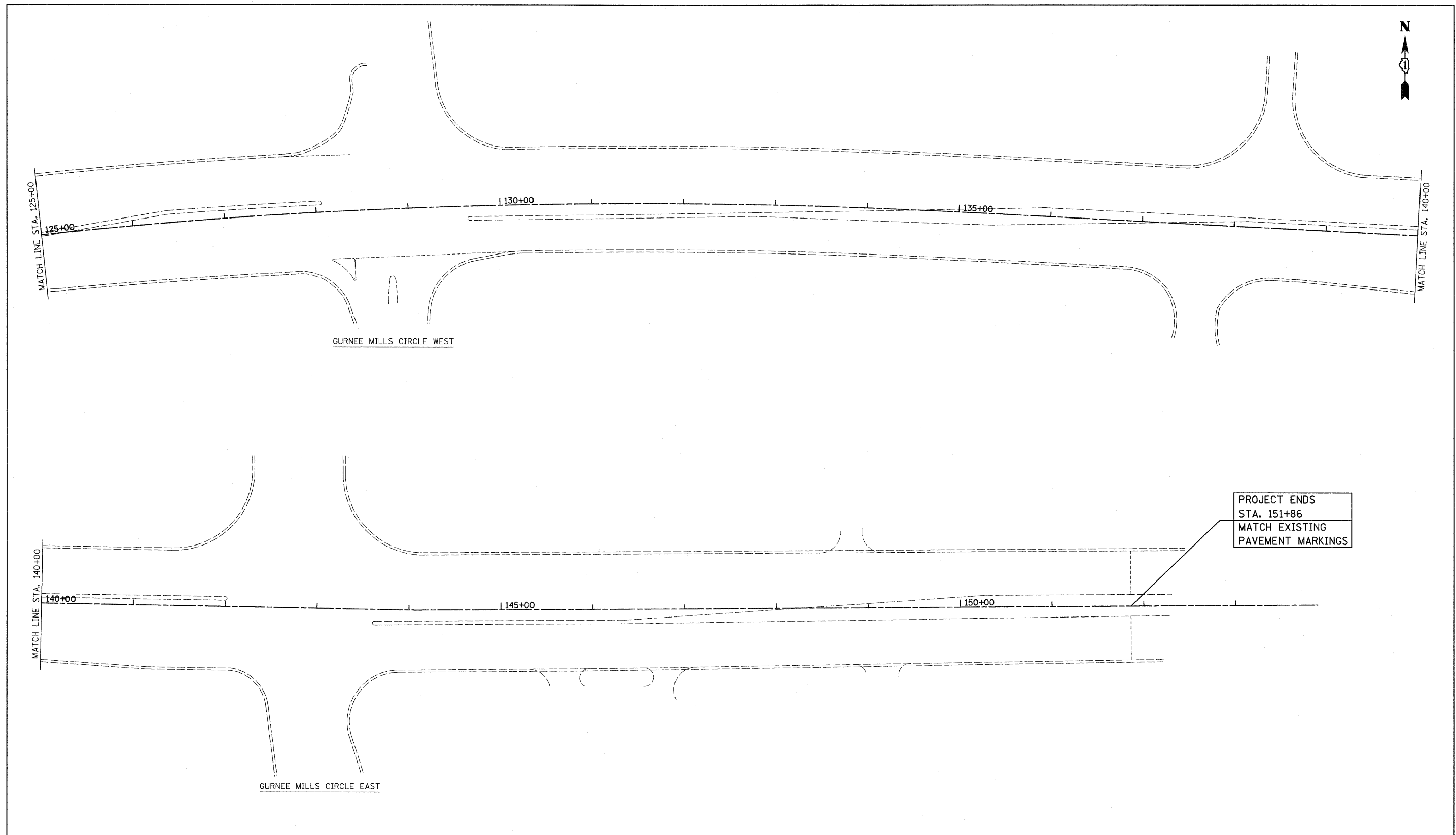

LEGEND					
1	LINE 4" (YELLOW SOLID LINE)	5	LINE 4" (WHITE SOLID LINE)	9	LINE 12" (WHITE SOLID LINE)
2	LINE 4" (DOUBLE YELLOW SOLID LINES)	6	LINE 6" (WHITE SOLID LINE)	10	LINE 12" (WHITE DIAGONAL LINE)
3	LINE 4" (YELLOW - 10' DASH, 30' SKIP)	7	LINE 6" (WHITE LANE LINE - 2' DASH, 6' SKIP)	11	LINE 12" (YELLOW DIAGONAL LINE)
4	LINE 4" (WHITE LANE LINE - 10' DASH, 30' SKIP)	8	LINE 8" (WHITE SOLID LINE)	12	LINE 24" (WHITE STOP BAR)
				13	LETTERS AND SYMBOLS (TYP.)

NOTES:

1. ALL PAVEMENT MARKINGS SHALL BE THERMOPLASTIC UNLESS OTHERWISE SPECIFIED.
2. RAISED REFLECTIVE PAVEMENT MARKERS SHALL BE USED THROUGHOUT THE PROJECT LIMITS. SEE DISTRICT DETAIL TC-11.

FILE NAME = D160678-shr-pmk5.dgn
 PLOT DATE = 4/15/2009



DESIGNED - M.P.	REVISED -
DRAWN - B.K.	REVISED -
CHECKED - G.F.L.	REVISED -
DATE - APRIL 2009	REVISED -

**STATE OF ILLINOIS
 DEPARTMENT OF TRANSPORTATION**

**PAVEMENT MARKING PLAN
 IL. RTE. 132**

SCALE: 1" = 50' SHEET NO. 5 OF 5 SHEETS STA. 125+00 TO STA. 151+86

F.A.P. RTE.	SECTION	COUNTY	TOTAL SHEETS	SHEET NO.
541	(X-R & T-13-A) RS-1	LAKE	29	15
CONTRACT NO. 60G78				
FED. ROAD DIST. NO. 1 ILLINOIS FED. AID PROJECT				

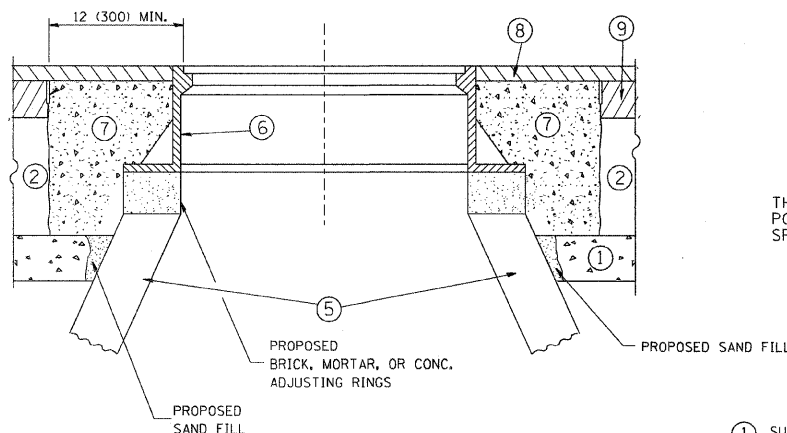
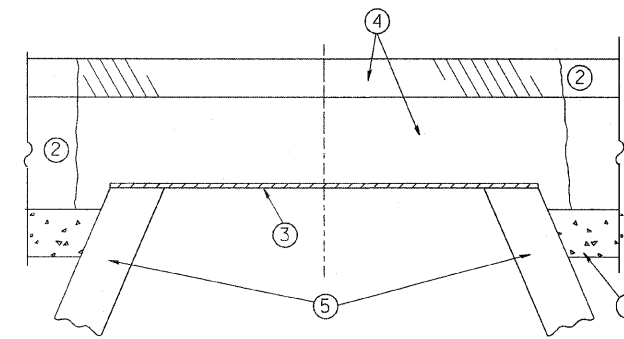

CONSTRUCTION PROCEDURES

- STAGE 1 (BEFORE PAVEMENT MILLING)**
- A) REMOVE A MINIMUM OF 12 (300) OF THE PAVEMENT FROM AROUND THE STRUCTURE.
 - B) REMOVE THE EXISTING FRAME AND LID FROM THE STRUCTURE.
 - C) COVER THE STRUCTURE OPENING WITH A 36 (900) DIAMETER METAL PLATE.
 - D) BACKFILL WITH CRUSHED STONE AND A MINIMUM 1/2 (40) THICK HMA SURFACE MIX APPROVED BY THE ENGINEER.
- STAGE 2 (AFTER PAVEMENT MILLING)**
- A) REMOVE THE HMA SURFACE MIX AND CRUSHED STONE.
 - B) INSTALL THE FRAME AND LID; ADJUST THE FRAME TO ITS FINAL SURFACE ELEVATION.
 - C) THE SURROUNDING SPACE SHALL BE FILLED WITH CLASS SI CONCRETE, OR HMA SURFACE COURSE OR HMA BINDER COURSE TO THE ELEVATION OF THE SURFACE OF THE EXISTING BASE COURSE OR THE BINDER COURSE.

THE PROCEDURE EXPLAINED ABOVE SHALL CONFORM TO THE APPLICABLE PORTIONS OF SECTIONS 353, 406, 602, AND 603 OF THE STANDARD SPECIFICATIONS.

LEGEND

- ① SUB-BASE GRANULAR MATERIAL
- ② EXISTING PAVEMENT
- ③ 36 (900) DIAMETER METAL PLATE
- ④ PROPOSED CRUSHED STONE AND HMA SURFACE MIX
- ⑤ EXISTING STRUCTURE
- ⑥ FRAME AND LID (SEE NOTES)
- ⑦ CLASS SI CONCRETE, HMA SURFACE COURSE OR HMA BINDER COURSE
- ⑧ PROPOSED HMA SURFACE COURSE
- ⑨ PROPOSED HMA BINDER COURSE

LOCATION OF STRUCTURES:

THE CONTRACTOR WILL BE REQUIRED TO KEEP A RECORD OF THE LOCATIONS OF THE BURIED STRUCTURES ACCORDING TO THE STATION AND DISTANCE LEFT OR RIGHT OF THE CENTERLINE OF PAVEMENT. UPON COMPLETION OF THE WORK, THE CONTRACTOR WILL DELIVER THE RECORD TO THE ENGINEER.

BASIS OF PAYMENT: THIS WORK WILL BE PAID FOR AT THE CONTRACT UNIT PRICE PER EACH FOR "FRAMES AND LIDS TO BE ADJUSTED, SPECIAL"
NEW FRAMES AND LIDS, WHEN SPECIFIED, WILL BE PAID FOR SEPARATELY.

NOTES:

EXISTING BROKEN FRAMES AND LIDS SHALL BE REMOVED AND DISPOSED OF BY THE CONTRACTOR AND SHALL BE REPLACED AS DIRECTED BY THE ENGINEER. REPLACEMENT FRAMES AND LIDS WILL BE PAID FOR IN ACCORDANCE WITH ARTICLE 109.04 OF THE STANDARD SPECIFICATIONS UNLESS A SEPARATE PAY ITEM HAS BEEN PROVIDED.

IF THE EXISTING LIDS ARE OPEN, THE FRAME WILL BE ADJUSTED TO THE ELEVATION OF THE MILLED PAVEMENT SURFACE PRIOR TO THE MILLING OPERATION. THE FRAME WILL NOT BE REMOVED AND COVERED BY THE METAL PLATE.

CITY OF CHICAGO CASTINGS ARE THE PROPERTY OF THE CITY AND THE CONTRACTOR SHALL NOTIFY THE CITY FOR REMOVAL AND DISPOSITION OF THE CASTINGS.

THE METAL PLATE USED TO COVER THE STRUCTURE SHALL REMAIN THE PROPERTY OF THE CONTRACTOR.

WHEN STRUCTURES ARE TO BE ADJUSTED OR RECONSTRUCTED, THE LOWERING AND RAISING OF THE FRAMES AND LIDS WILL NOT BE PAID FOR SEPARATELY BUT WILL BE INCLUDED IN THE COST OF THE CORRESPONDING PAY ITEM.

DETAILS FOR FRAMES AND LIDS ADJUSTMENT WITH MILLING

ALL DIMENSIONS ARE IN INCHES (MILLIMETERS) UNLESS OTHERWISE SHOWN

FILE NAME = W:\diststd\22x34\bd08.dgn	USER NAME = gegljanobt	DESIGNED - R. SHAH	REVISED - R. SHAH 03-10-95	STATE OF ILLINOIS DEPARTMENT OF TRANSPORTATION	DETAILS FOR FRAMES AND LIDS ADJUSTMENT WITH MILLING			F.A.P. RATE: 541	SECTION (X-R & T-13-A) RS-1	COUNTY LAKE	TOTAL SHEETS 29	SHEET NO. 16
	PLOT SCALE = 50.0000' / IN.	CHECKED -	REVISED - A. ABBAS 03-21-97		SCALE: NONE	SHEET NO. 1 OF 1 SHEETS	STA. TO STA.	BD600-03 (BD-B)		CONTRACT NO. 60G78		
	PLOT DATE = 1/4/2008	DATE - 10-25-94	REVISED - R. WIEDEMAN 05-14-04		FED. ROAD DIST. NO. 1 ILLINOIS FED. AID PROJECT							
			REVISED - R. BORO 01-01-07									

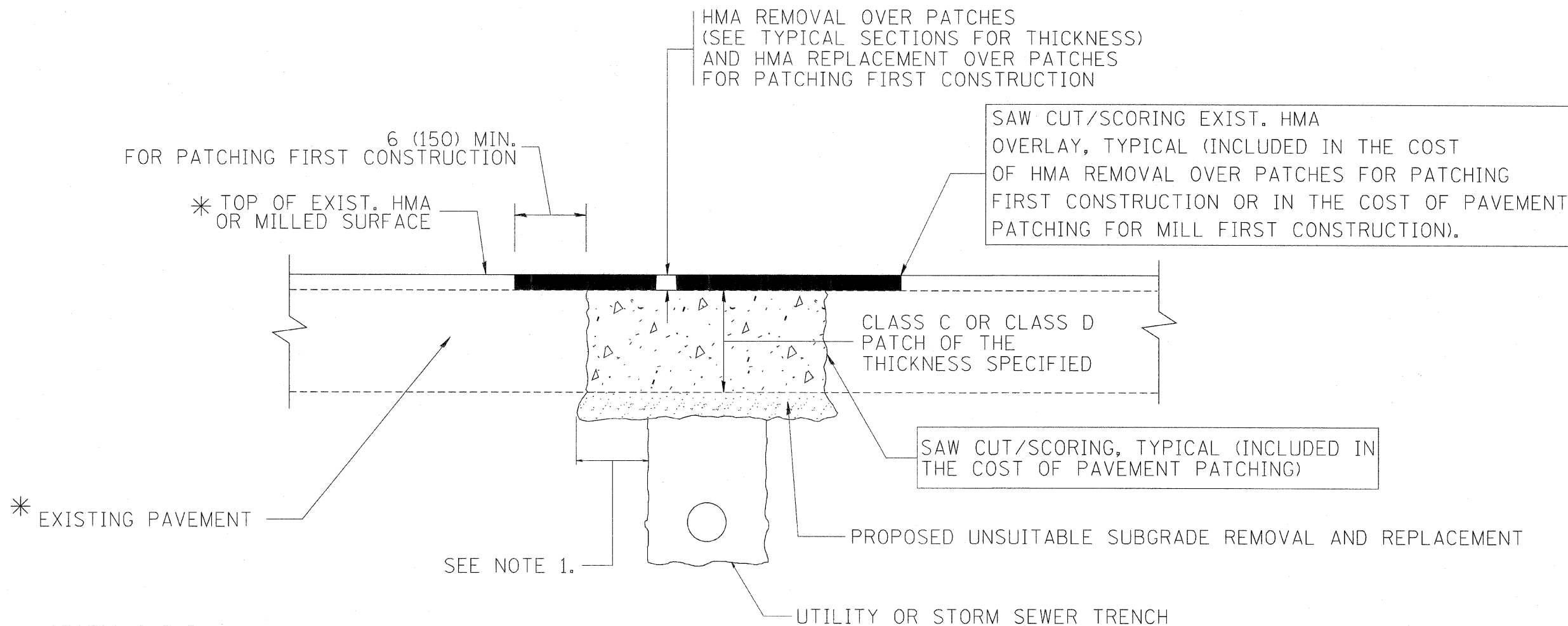

* SEE TYPICAL SECTIONS FOR THICKNESS AND MATERIALS

NOTES:

1. THE WIDTH OF THE FULL DEPTH PATCH OVER A TRENCH SHALL BE 12 (300) WIDER ON EACH SIDE OF THE TRENCH.
2. FOR METHOD OF MEASUREMENT AND BASIS OF PAYMENT, SEE RECURRING SPECIAL PROVISION "PATCHING WITH HOT-MIX ASPHALT OVERLAY REMOVAL".

SEQUENCE OF CONSTRUCTION (PATCHING FIRST)

1. REMOVE THE EXISTING HMA MATERIAL OVER THE AREA TO BE PATCHED.
2. REMOVE AND REPLACE WITH CLASS C OR D PATCH.
3. REPLACE HMA MATERIAL OVER THE AREA TO BE PATCHED.

SEQUENCE OF CONSTRUCTION (MILLING FIRST)

1. MILL HMA FIRST IF THERE IS AT LEAST 4 1/2 INCHES OR MORE OF HMA MATERIAL ON TOP OF THE EXISTING PAVEMENT OR IF THE PAVEMENT IS FULL DEPTH HMA. A MINIMUM OF 2 INCHES OF HMA MATERIAL SHALL BE IN PLACE AFTER MILLING.
2. REMOVE AND REPLACE WITH FULL DEPTH CLASS D PATCHES TO TOP OF MILLED SURFACE.

ALL DIMENSIONS ARE IN INCHES (MILLIMETERS) UNLESS OTHERWISE SHOWN.

FILE NAME = c:\projects\distsd22x34\bd22.dgn	USER NAME = bauerdl	DESIGNED - R. SHAH	REVISED - A. ABBAS 04-27-98
		DRAWN -	REVISED - R. BORO 01-01-07
	PLOT SCALE = 50.000' / IN.	CHECKED -	REVISED - R. BORO 09-04-07
	PLOT DATE = 10/27/2008	DATE - 10-25-94	REVISED - K. ENG 10-27-08

**STATE OF ILLINOIS
DEPARTMENT OF TRANSPORTATION**

PAVEMENT PATCHING FOR HMA SURFACED PAVEMENT	
SCALE: NONE	SHEET NO. 1 OF 1 SHEETS STA. TO STA.

F.A.P. RTE. 541	SECTION (X-R & T-13-A) RS-1	COUNTY LAKE	TOTAL SHEETS 29	SHEET NO. 17
BD400-04 (BD-22)			CONTRACT NO. 60G78	
FED. ROAD DIST. NO. 1 ILLINOIS FED. AID PROJECT				

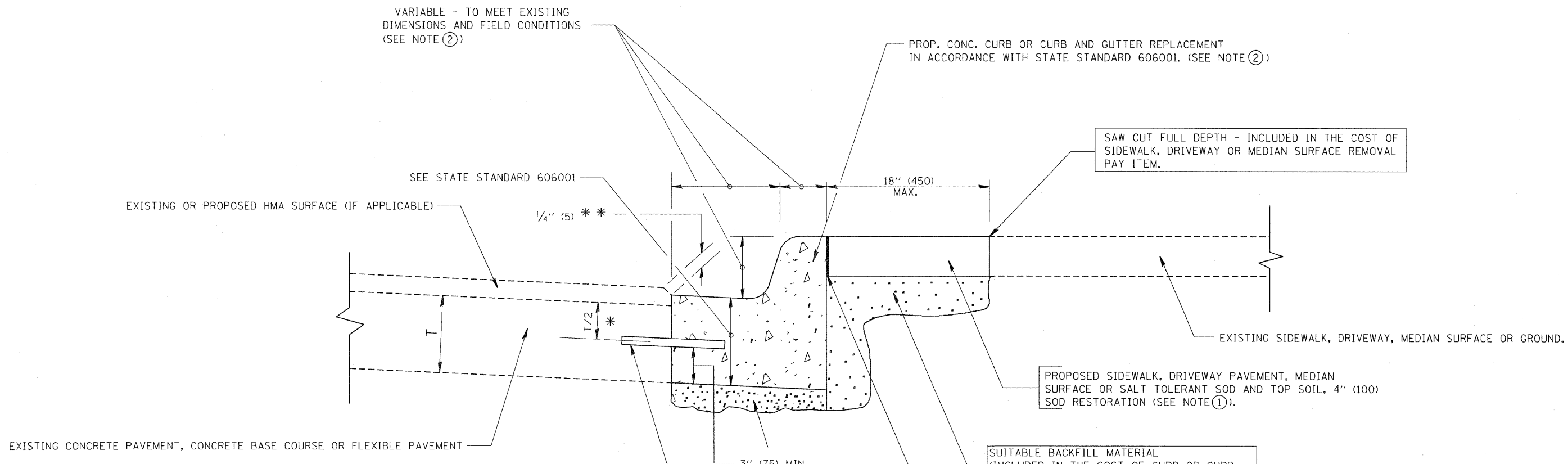

- * 3" (75) MINIMUM FROM TOP AND BOTTOM OF THE CONCRETE PAVEMENT OR BASE COURSE.
- ** IF THE FINAL SURFACE OF THE PAVEMENT IS CONCRETE, THE GUTTER IS TO BE FLUSH WITH THE PAVEMENT.

NOTE: ① SIDEWALK, DRIVEWAY PAVEMENT OR MEDIAN SURFACE SHALL BE SIMILAR TO THE MATERIAL BEING REMOVED AND WILL BE PAID FOR SEPARATELY.

SALT TOLERANT SOD AND TOP SOIL, 4" (100) RESTORATION WILL NOT BE PAID FOR SEPARATELY, BUT SHALL BE INCLUDED IN THE COST OF CURB OR CURB AND GUTTER REMOVAL AND REPLACEMENT.

- ② CURB OR CURB AND GUTTER REPLACEMENT SHALL MATCH THE SHAPE OF THE EXISTING CURB OR CURB AND GUTTER UNLESS OTHERWISE SPECIFIED.
- ③ FOR CURB OR CURB AND GUTTER REMOVAL AND REPLACEMENT ADJACENT TO FLEXIBLE PAVEMENT DELETE EPOXY COATED TIE BARS.
- ④ LONGITUDINAL BARS, IF ENCOUNTERED IN THE EXISTING CURB OR CURB AND GUTTER, ARE NOT TO BE REPLACED. CUTTING AND REMOVING LONGITUDINAL BARS SHALL BE INCLUDED IN THE COST OF CURB OR CURB AND GUTTER REMOVAL AND REPLACEMENT.
- ⑤ THE COST OF HMA SURFACE REMOVAL IN THE EXISTING GUTTER FLAG SHALL BE INCLUDED IN THE COST OF THE CURB AND GUTTER REMOVAL AND REPLACEMENT.
- ⑥ THE REMOVAL AND REPLACEMENT OF THE EXISTING CURB OR CURB AND GUTTER SHALL BE DONE IN ACCORDANCE WITH THE APPLICABLE PORTIONS OF SECTION 440 AND 606 OF THE STANDARD SPECIFICATIONS.
- ⑦ THE LOCATIONS OF REMOVAL AND REPLACEMENT OF EXISTING CURB OR CURB AND GUTTER SHALL BE DETERMINED BY THE RESIDENT ENGINEER AT THE TIME OF CONSTRUCTION.

UNUSABLE SUB-BASE MATERIAL TO BE REMOVED, IF DIRECTED BY THE ENGINEER, SHALL BE REPLACED WITH EITHER SUB-BASE GRANULAR MATERIAL, TYPE B OR ADDITIONAL THICKNESS OF CONCRETE.

REMOVAL AND REPLACEMENT 4" (100) OR LESS IS INCLUDED IN THE COST OF CURB OR CURB AND GUTTER REMOVAL AND REPLACEMENT.

REMOVAL AND REPLACEMENT IN EXCESS OF 4" (100) WILL BE PAID FOR IN ACCORDANCE WITH ARTICLE 109.04 OF THE STANDARD SPECIFICATIONS.

PROPOSED #6 (20) EPOXY COATED TIE BARS 24" (600) LONG AT 24" (600) CENTERS WILL NOT BE PAID FOR SEPARATELY. DELETE EPOXY COATED TIE BARS IF EXISTING TIE BARS ARE USUABLE AS DETERMINED BY THE ENGINEER. (SEE NOTE ③).

BASIS OF PAYMENT:

THIS WORK WILL BE PAID FOR AT THE CONTRACT UNIT PRICE PER FOOT (METER) FOR "CURB REMOVAL AND REPLACEMENT" OR "COMBINATION CONCRETE CURB AND GUTTER REMOVAL AND REPLACEMENT".

CURB OR CURB AND GUTTER REMOVAL AND REPLACEMENT

ALL DIMENSIONS ARE IN INCHES (MILLIMETERS) UNLESS OTHERWISE SHOWN.

FILE NAME = W:\diststd\22x34\bd24.dgn	USER NAME = geglionob	DESIGNED - A. HOUSEH	REVISED - R. SHAH 10-03-96	STATE OF ILLINOIS DEPARTMENT OF TRANSPORTATION	CURB OR CURB AND GUTTER REMOVAL AND REPLACEMENT	F.A.P. RTE. 641	SECTION (X-R & T-13-A) RS-1	COUNTY LAKE	TOTAL SHEETS 29	SHEET NO. 18
PLOT SCALE = 50.000' / IN.	CHECKED -	DATE - 03-11-94	REVISED - A. ABBAS 03-21-97			BD600-06 (BD-24)		CONTRACT NO. 60G78		
PLOT DATE = 1/4/2008			REVISED - M. GOMEZ 01-22-01		SCALE: NONE	SHEET NO. 1 OF 1 SHEETS	STA.	TO STA.	FED. ROAD DIST. NO. 1 ILLINOIS FED. AID PROJECT	

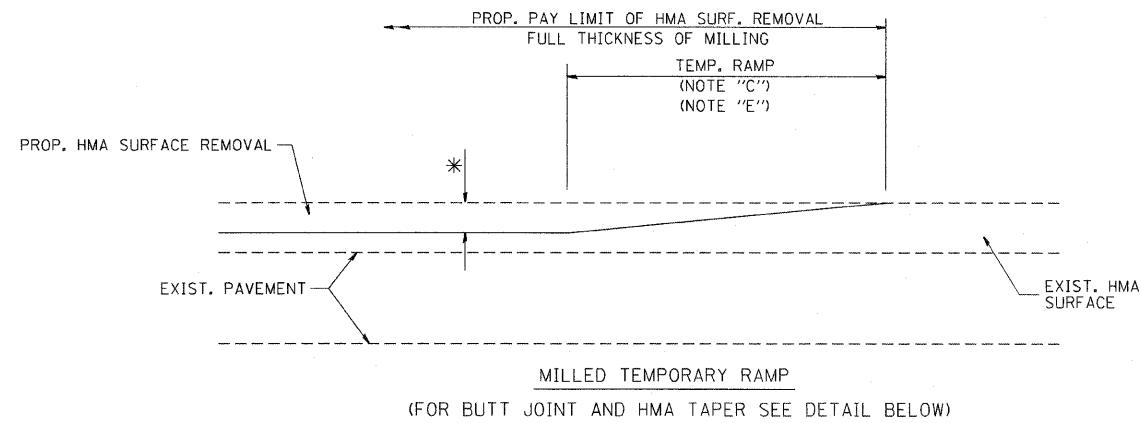

OPTION 1

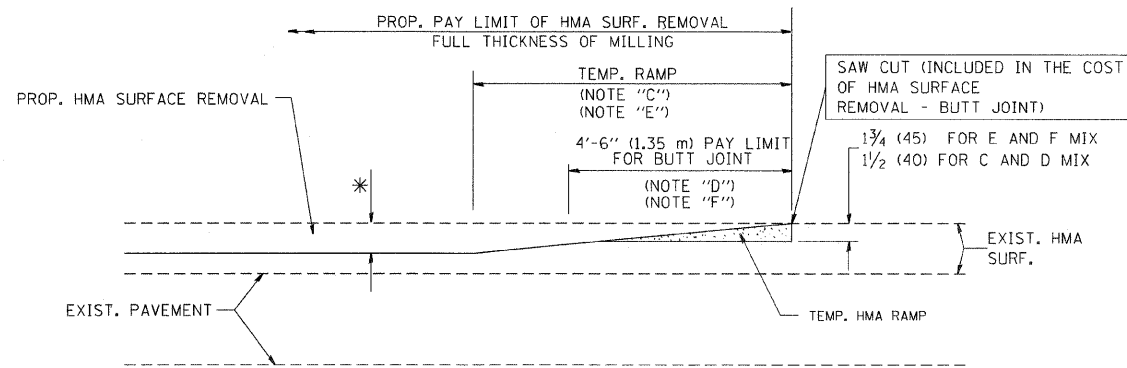

HMA CONSTRUCTED TEMPORARY RAMP
(FOR BUTT JOINT AND HMA TAPER SEE DETAIL BELOW)

OPTION 2

TYPICAL TEMPORARY RAMP

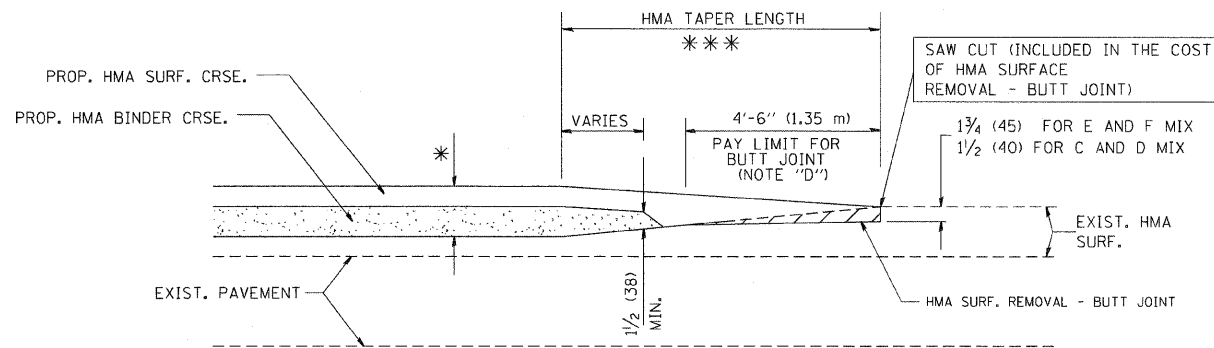

TYPICAL BUTT JOINT AND HMA TAPER
FOR MILLING AND RESURFACING

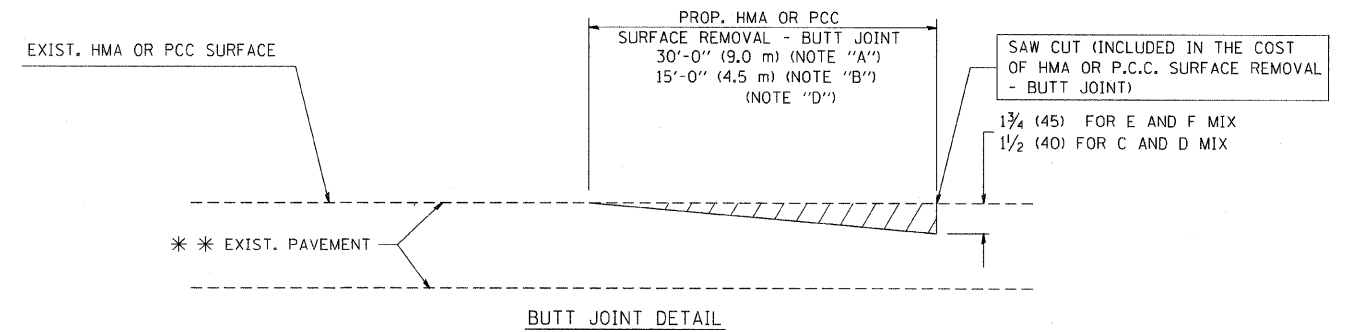

BUTT JOINT DETAIL

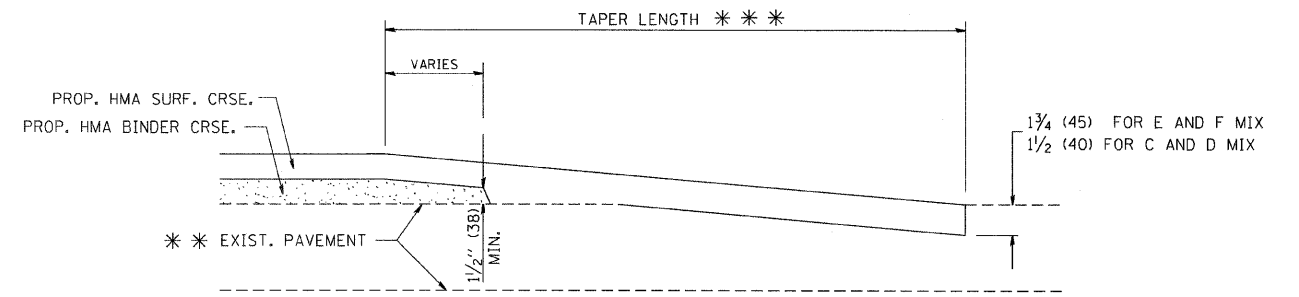

HMA TAPER DETAIL

TYPICAL BUTT JOINT AND HMA TAPER
FOR RESURFACING ONLY

*** PC CONCRETE, HMA OR HMA RESURFACED PAVEMENT.

NOTES

- A: MAINLINE ROADWAYS AND MAJOR SIDE ROADS.
 - B: MINOR SIDE ROADS.
 - C: THE TEMP. RAMP SHALL BE CONSTRUCTED IMMEDIATELY UPON REMOVAL OF THE EXISTING HMA SURFACE.
 - D: THE BUTT JOINT SHALL BE CONSTRUCTED IMMEDIATELY PRIOR TO PLACING THE PROPOSED HMA COURSES.
 - E: TAPER THE TEMP. RAMP AT A RATE OF 3'-0" (900 mm) PER 1 INCH (25 mm) OF MILLING THICKNESS.
 - F: INSTALLATION AND REMOVAL OF THE 4'-6" (1.35 m) TEMP. RAMP IS INCLUDED IN COST OF HMA SURFACE REMOVAL - BUTT JOINT
 - G: SEE ARTICLE 406.08 AND 406.14 OF THE STANDARD SPECIFICATIONS FOR "HMA AND/OR PCC SURFACE REMOVAL, BUTT JOINT".
- * SEE TYPICAL SECTIONS FOR MILLING THICKNESS.
- *** 20'-0" (6.1 m) PER 1 (25) RESURFACING (NOTE "A")
10'-0" (3.0 m) PER 1 (25) RESURFACING (NOTE "B")

BASIS OF PAYMENT:

THE BUTT JOINT WILL BE PAID FOR AT THE CONTRACT UNIT PRICE PER SQUARE YARD (SQUARE METER) FOR "HOT-MIX ASPHALT SURFACE REMOVAL - BUTT JOINT" OR FOR "PORTLAND CEMENT CONCRETE SURFACE REMOVAL - BUTT JOINT".

ALL DIMENSIONS ARE IN INCHES (MILLIMETERS) UNLESS OTHERWISE SHOWN.

FILE NAME = W:\diststd\22x34\bd32.dgn	USER NAME = geglionobt	DESIGNED - M. DE YONG	REVISED - R. SHAH 10-25-94
		DRAWN -	REVISED - A. ABBAS 03-21-97
	PLOT SCALE = 50.0000 "/ IN.	CHECKED -	REVISED - M. GOMEZ 04-06-01
	PLOT DATE = 1/4/2008	DATE - 06-13-90	REVISED - R. BORO 01-01-07

STATE OF ILLINOIS
DEPARTMENT OF TRANSPORTATION

BUTT JOINT AND
HMA TAPER DETAILS

SCALE: NONE SHEET NO. 1 OF 1 SHEETS STA. TO STA.

F.A.P. RTE. 541	SECTION (X-R & T-13-A) RS-1	COUNTY LAKE	TOTAL SHEETS 29	SHEET NO. 19
BD400-05 BD32		CONTRACT NO. 60G78		
FED. ROAD DIST. NO. 1 ILLINOIS FED. AID PROJECT				

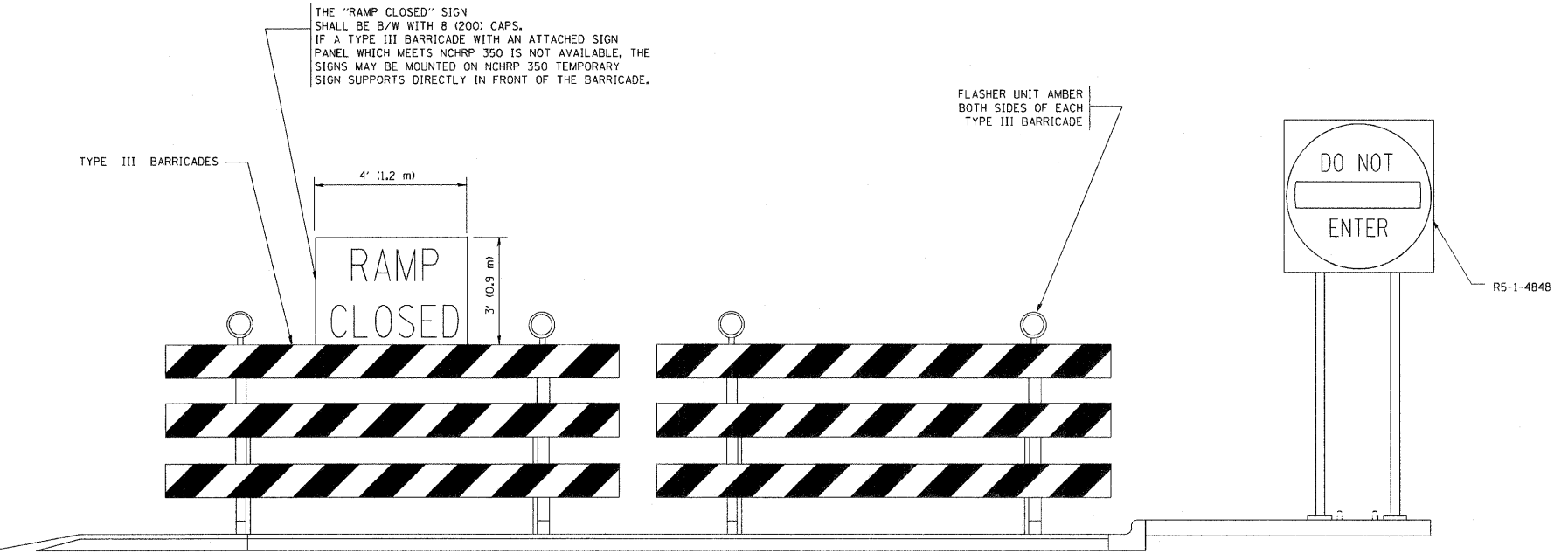
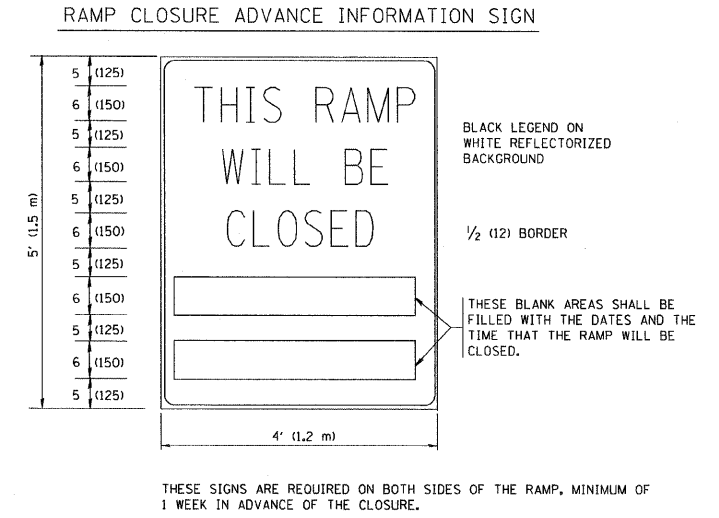
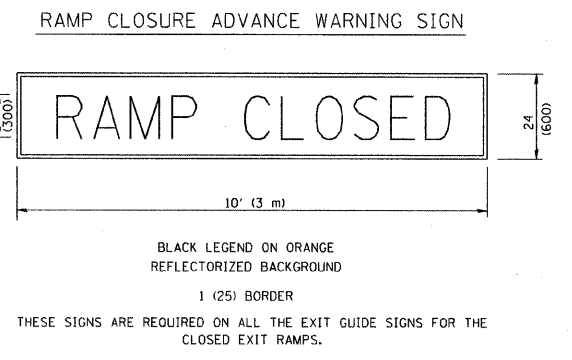
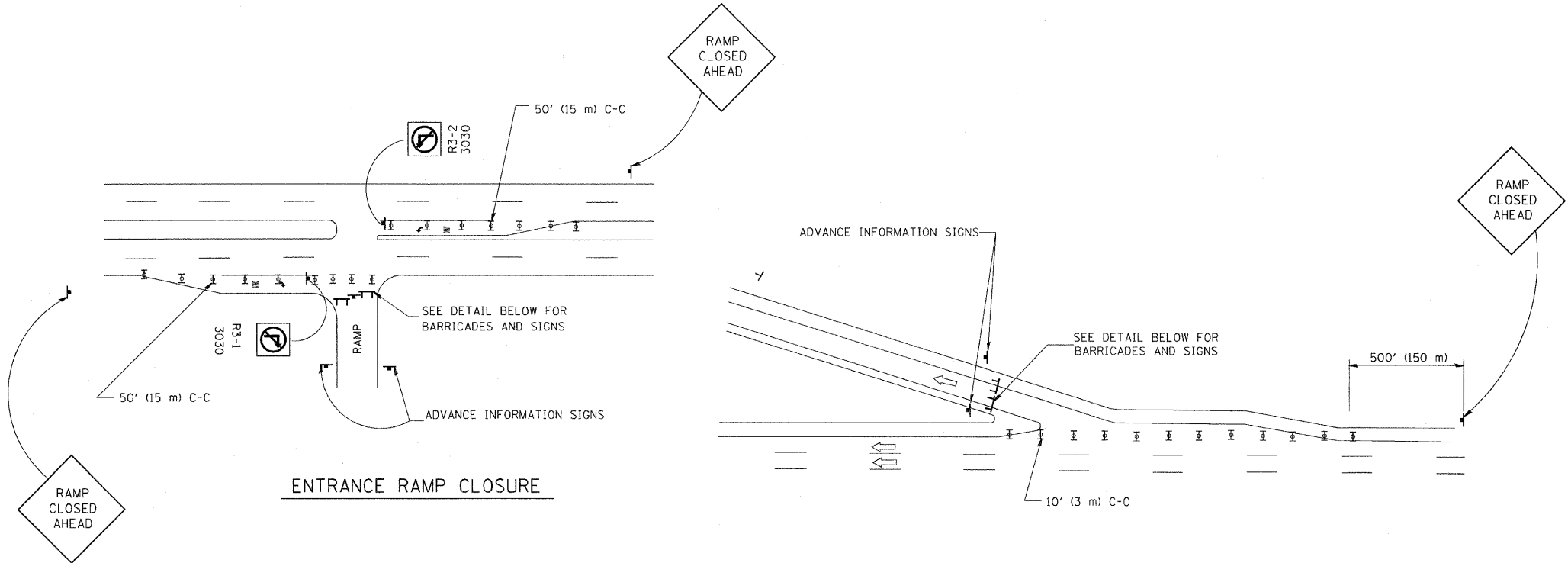

THE "RAMP CLOSED" SIGN SHALL BE B/W WITH 8 (200) CAPS. IF A TYPE III BARRICADE WITH AN ATTACHED SIGN PANEL WHICH MEETS NCHRP 350 IS NOT AVAILABLE, THE SIGNS MAY BE MOUNTED ON NCHRP 350 TEMPORARY SIGN SUPPORTS DIRECTLY IN FRONT OF THE BARRICADE.

DETAIL FOR REQUIRED BARRICADES & SIGNS

- SYMBOLS**
- ▬ TYPE II BARRICADE, DRUM OR VERTICAL BARRICADE WITH STEADY BURN MONO-DIRECTIONAL LIGHT
 - ⌊ TYPE III BARRICADE WITH FLASHING LIGHT

- GENERAL NOTES:
1. CONES MAY BE SUBSTITUTED FOR DRUMS OR TYPE II BARRICADES DURING DAY OPERATIONS. CONES SHALL BE A MINIMUM OF 28 (700) HIGH.
 2. STEADY BURN LIGHTS WILL NOT BE REQUIRED FOR DAY OPERATIONS.
 3. A FLAGGER SHALL BE POSITIONED AT EACH CLOSED RAMP THAT IS OPEN TO CONSTRUCTION VEHICLES.
 4. ALL ROUTE MARKERS AND TRAILBLAZER ASSEMBLIES WHICH DIRECT MOTORISTS TO A CLOSED ENTRANCE RAMP SHALL BE COVERED.
 5. THE SIGNING AND BARRICADING WHICH IS REQUIRED BY THIS DETAIL SHALL BE INCLUDED IN THE COST OF TRAFFIC CONTROL AND PROTECTION (EXPRESSWAYS).
 6. AUTHORIZATION FROM THE DISTRICT'S BUREAU OF TRAFFIC IS REQUIRED FOR ALL RAMP CLOSURES.
 7. THE RAMP CLOSURE ADVANCE INFORMATION SIGNS SHALL BE ERECTED IF THE CLOSURE TIME EXCEEDS TWENTY-FOUR (24) HOURS. ADDITIONAL ADVANCE WARNING SIGNS ON EXIT GUIDE SIGNING WILL BE REQUIRED FOR EXIT RAMP CLOSURES THAT EXCEED TWENTY-FOUR (24) HOURS IN LENGTH.

ALL DIMENSIONS ARE IN INCHES (MILLIMETERS) UNLESS OTHERWISE SHOWN.

FILE NAME = W:\diststd\22x34\to08.dgn	USER NAME = goglianobt	DESIGNED - DWS	REVISED - DWS 12-94	STATE OF ILLINOIS DEPARTMENT OF TRANSPORTATION	FREWAY ENTRANCE AND EXIT RAMP CLOSURE DETAILS		F.A.P. SITE: 541	SECTION: (X-R & T-13-A) RS-1	COUNTY: LAKE	TOTAL SHEETS: 29	SHEET NO.: 20
PLOT SCALE = 50.000' / IN.	CHECKED -	REVISED - DWS/JAF 12-02	REVISED - JAF 02-06		SCALE: NONE	SHEET NO. 1 OF 1 SHEETS	STA. 12+17	TO STA. 118+57	TC-08		CONTRACT NO. 60G78
PLOT DATE = 1/4/2008	DATE - 02-83	REVISED - SPB 01-07			FED. ROAD DIST. NO. 1 ILLINOIS FED. AID PROJECT						

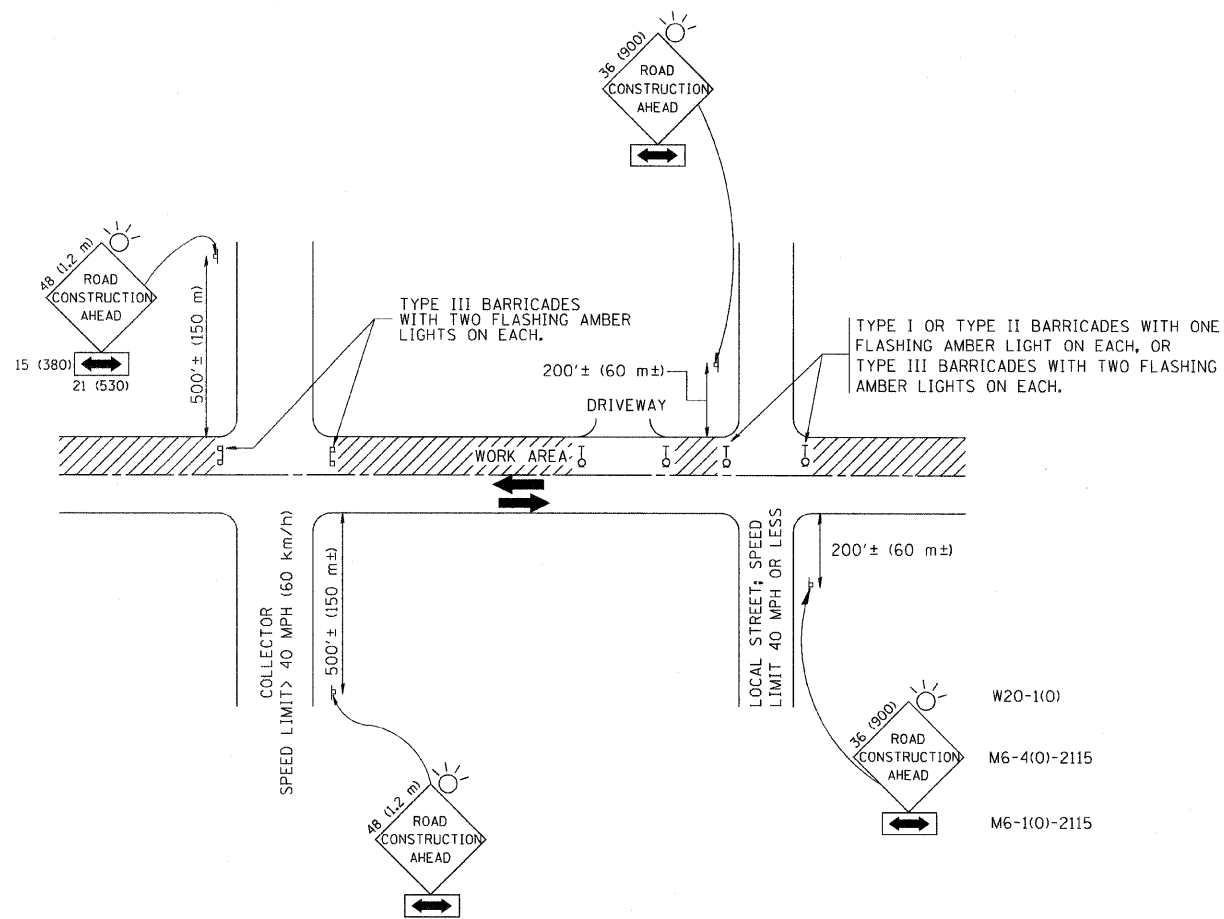

TRAFFIC CONTROL AND PROTECTION FOR SIDE ROADS, INTERSECTIONS, AND DRIVEWAYS

NOTES:

- A. FOR NO LANE RESTRICTION ON THE SIDE ROAD OR DRIVEWAYS
- SIDE ROAD WITH A SPEED LIMIT OF 40 MPH (60 km/h) OR LESS AS SHOWN ON THE DRAWING AND AS DIRECTED BY THE ENGINEER:
 - ONE **ROAD CONSTRUCTION AHEAD** SIGN 36 x 36 (900x900) WITH A FLASHER AND FLAG MOUNTED ON IT APPROXIMATELY 200' (60 m) IN ADVANCE OF THE MAIN ROUTE.
 - THE CLOSED PORTION OF THE MAIN ROUTE SHALL BE PROTECTED BY BLOCKING WITH TYPE I, TYPE II OR TYPE III BARRICADES, 1/3 OF THE CROSS SECTION OF THE CLOSED PORTION.
 - SIDE ROAD WITH A SPEED LIMIT GREATER THAN 40 MPH (60 km/h) AS SHOWN ON THE DRAWING AND AS DIRECTED BY THE ENGINEER:
 - ONE **ROAD CONSTRUCTION AHEAD** SIGN 48 x 48 (1.2 m x 1.2 m) WITH A FLASHER MOUNTED ON IT APPROXIMATELY 500' (150 m) IN ADVANCE OF THE MAIN ROUTE.
 - THE CLOSED PORTION OF THE MAIN ROUTE SHALL BE PROTECTED BY BLOCKING WITH TYPE III BARRICADES, 1/2 OF THE CROSS SECTION OF THE CLOSED PORTION.
 - WHEN THE SIDE ROAD LIES BETWEEN THE BEGINNING OF THE MAINLINE SIGNING AND THE WORK ZONE, A SINGLE HEADED ARROW (M6-1) SHALL BE USED IN LIEU OF THE DOUBLE HEADED ARROW (M6-4).
- B. FOR A LANE CLOSURE ON A SIDE ROAD OR DRIVEWAY:
- USE APPLICABLE PORTIONS OF THE TYPICAL APPLICATION OF TRAFFIC CONTROL DEVICES (STD. 701501, STD. 701606 OR THE APPROPRIATE STANDARD). THE SPACING OF SIGNS AND BARRICADES SHALL BE ADJUSTED FOR FIELD CONDITIONS AS DIRECTED BY THE ENGINEER. THE DIRECTIONAL ARROW SHALL BE COVERED OR REMOVED WHEN NO LONGER CONSISTENT WITH THE SIDE ROAD LANE CLOSURE.
- C. ADVANCE WARNING SIGNS ARE TO BE OMITTED ON DRIVEWAY UNLESS OTHERWISE NOTED.
- D. THE TRAFFIC CONTROL AND PROTECTION FOR SIDE ROADS, INTERSECTIONS, AND DRIVEWAYS SHALL BE INCIDENTAL TO THE COST OF SPECIFIED TRAFFIC CONTROL STANDARDS OR ITEMS.

All dimensions are in millimeters (inches) unless otherwise shown.

FILE NAME = W:\diststd\22x34\tc10.dgn	USER NAME = gegienobt	DESIGNED - LHA	REVISED - J. OBERLE 10-18-95
		DRAWN -	REVISED - A. HOUSEH 03-06-96
	PLOT SCALE = 50,000' / IN.	CHECKED -	REVISED - A. HOUSEH 10-15-96
	PLOT DATE = 1/4/2008	DATE - 06-89	REVISED - T. RAMMACHER 01-06-00

STATE OF ILLINOIS
DEPARTMENT OF TRANSPORTATION

TRAFFIC CONTROL AND PROTECTION FOR SIDE ROADS, INTERSECTIONS, AND DRIVEWAYS			
SCALE: NONE	SHEET NO. 1 OF 1 SHEETS	STA.	TO STA.

F.A.P. RTE.	SECTION	COUNTY	TOTAL SHEETS	SHEET NO.
841	(X-R & T-13-A) RS-1	LAKE	29	21
TC-10			CONTRACT NO. 60G78	
FED. ROAD DIST. NO. 1 ILLINOIS FED. AID PROJECT				

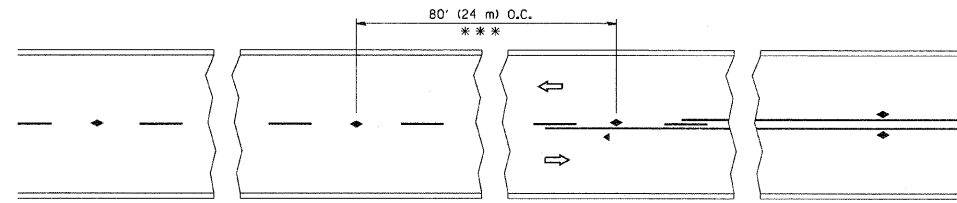

*** REDUCE TO 40' (12 m) O.C. ON CURVES WITH POSTED OR ADVISORY SPEED 45 M.P.H. (70 km/h) OR LESS.

TWO-LANE/TWO-WAY

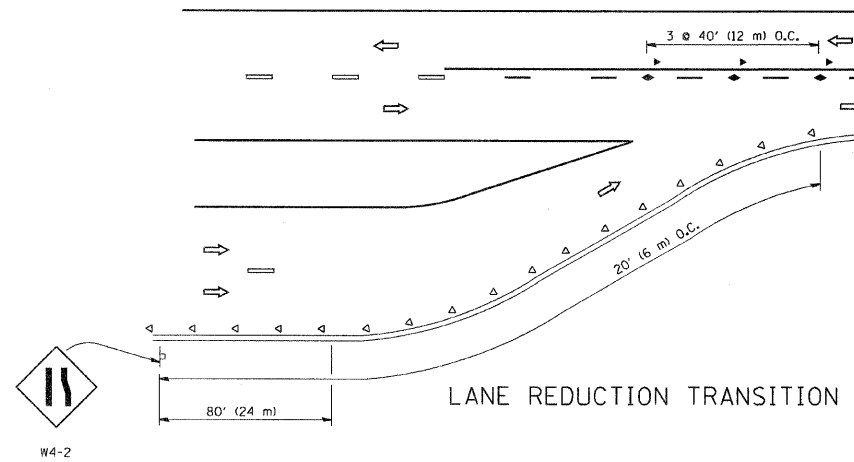

LANE REDUCTION TRANSITION

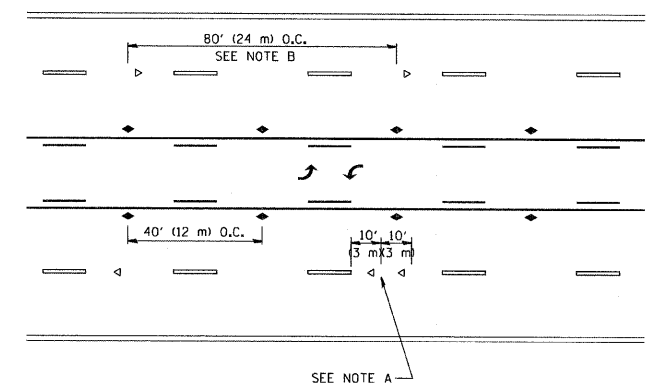

TWO-WAY LEFT TURN

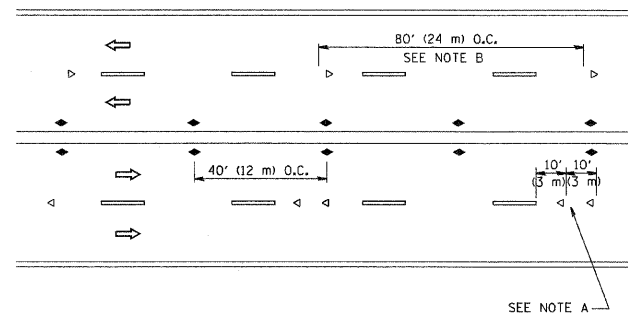

MULTI-LANE/UNDIVIDED

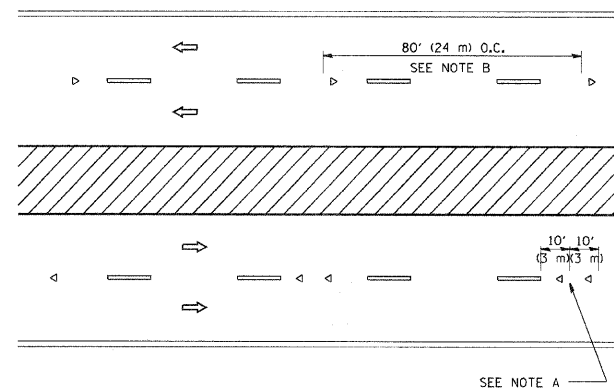

MULTI-LANE/DIVIDED

GENERAL NOTES

1. MARKERS USED WITH DASHED LINES SHALL BE CENTERED IN THE GAP BETWEEN SEGMENTS.
2. MARKERS USED ADJACENT TO SOLID LINES SHALL BE OFFSET 2 TO 3 (50 TO 75) TOWARD TRAFFIC AS SHOWN.
3. MARKERS THROUGH TANGENTS LESS THAN 500' (150 m) IN LENGTH BETWEEN CURVES SHALL BE INSTALLED AT THE LESSER OF THE TWO CURVE SPACINGS.

SYMBOLS

- YELLOW STRIPE
- WHITE STRIPE
- ◄ ONE-WAY AMBER MARKER
- ◄ ONE-WAY CRYSTAL MARKER (W/O)
- ◆ TWO-WAY AMBER MARKER

LANE MARKER NOTES

- B. REDUCE TO 40' (12 m) O.C. ON CURVES WHERE ADVISORY SPEEDS ARE 10 M.P.H. (20 km/h) LOWER THAN POSTED SPEEDS.
- A. USE DOUBLE LANE LINE MARKERS SPACED AS SHOWN.

DESIGN NOTES

1. DOUBLE LANE LINE MARKERS SHALL BE USED UNLESS SPECIFIED OTHERWISE.
2. EXCEPT AS SHOWN ON THE LANE REDUCTION TRANSITION AND FREEWAY EXIT RAMP DETAIL, MARKERS ARE NOT TO BE SPECIFIED ON RIGHT EDGE LINES.
3. THE EXACT MARKER LIMITS, SPACING, AND COLOR SHOULD BE INCLUDED IN THE PLANS.
4. MARKERS SHOULD NOT BE USED ALONGSIDE CURBS EXCEPT FOR EXTREMELY SHORT SECTIONS OF CURBS WHERE NOT MORE THAN TWO MARKERS WOULD BE INVOLVED.

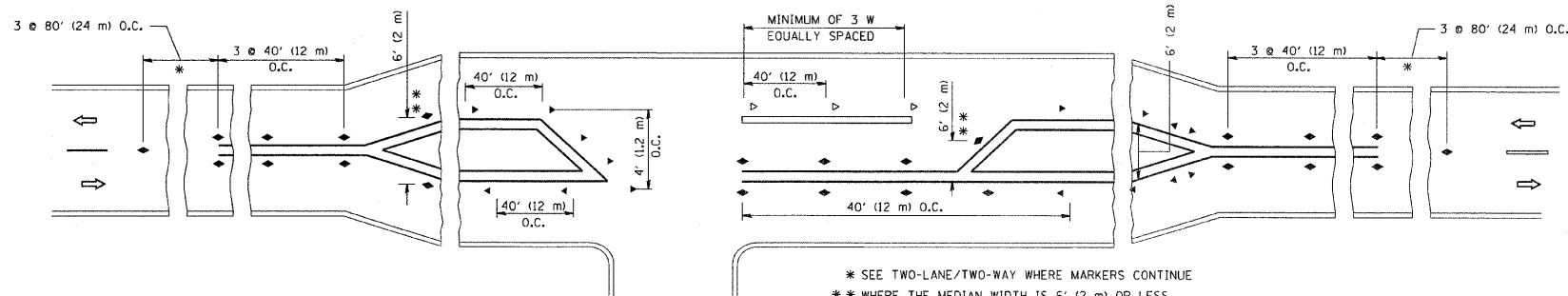

LEFT TURN

* SEE TWO-LANE/TWO-WAY WHERE MARKERS CONTINUE
 ** WHERE THE MEDIAN WIDTH IS 6' (2 m) OR LESS USE TWO-WAY MARKERS.

All dimensions are in inches (millimeters) unless otherwise shown.

FILE NAME = W:\diststd\22x34\to11.dgn	USER NAME = geglionobt	DESIGNED -	REVISED - T. RAMMACHER 09-19-94	STATE OF ILLINOIS DEPARTMENT OF TRANSPORTATION	TYPICAL APPLICATIONS			F.A.P. RTE.	SECTION	COUNTY	TOTAL SHEETS	SHEET NO.
	PLOT SCALE = 50,000' / IN.	DRAWN -	REVISED - T. RAMMACHER 03-12-99		RAISED REFLECTIVE PAVEMENT MARKERS (SNOW-PLOW RESISTANT)			541	(X-R & T-13-A) RS-1	LAKE	29	22
PLOT DATE = 1/4/2008	CHECKED -	REVISED - T. RAMMACHER 01-06-00	REVISED -	SCALE: NONE	SHEET NO. 1 OF 1 SHEETS	STA.	TO STA.	TC-11		CONTRACT NO. 60G78		
	DATE -	REVISED -					FED. ROAD DIST. NO. 1		ILLINOIS FED. AID PROJECT			

THE DIAGONAL LINES SHALL BE SPACED AT 40' (12 m) C-C ACROSS ALL STRUCTURES WHICH ARE 500' (150 m) OR LESS IN LENGTH
 THE DIAGONAL LINES ARE NOT REQUIRED ON SHOULDERS WHICH ARE 6' (1.8 m) OR LESS IN WIDTH

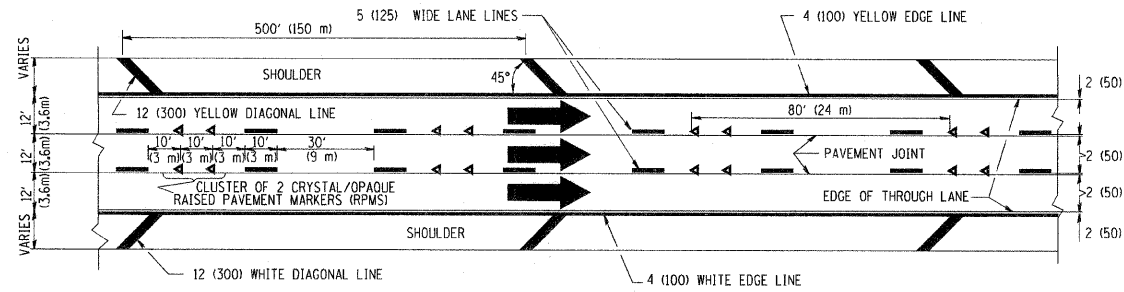

TYPICAL EDGE LINES & LANE LINES

- NOTES:
1. THERMO PLASTIC PAVEMENT MARKING LINE SHALL BE USED FOR THE EDGE LINES, GORE LINES, AND DIAGONAL LINES ON BITUMINOUS PAVEMENT ONLY.
 2. PREFORMED PLASTIC TYPE B PAVEMENT MARKING LINE SHALL BE USED FOR ALL LANE LINES ON BITUMINOUS PAVEMENT
 3. POLYUREA PAVEMENT MARKING SHALL BE USED FOR ALL MARKINGS ON PCC

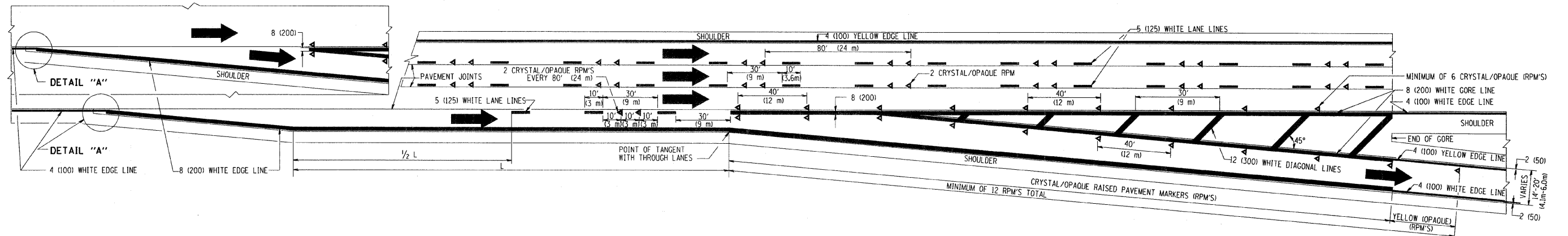
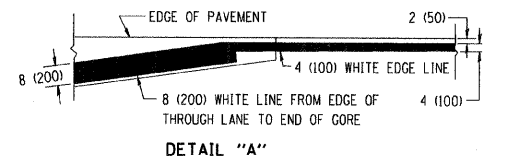

TYPICAL EXIT RAMP PAVEMENT MARKINGS

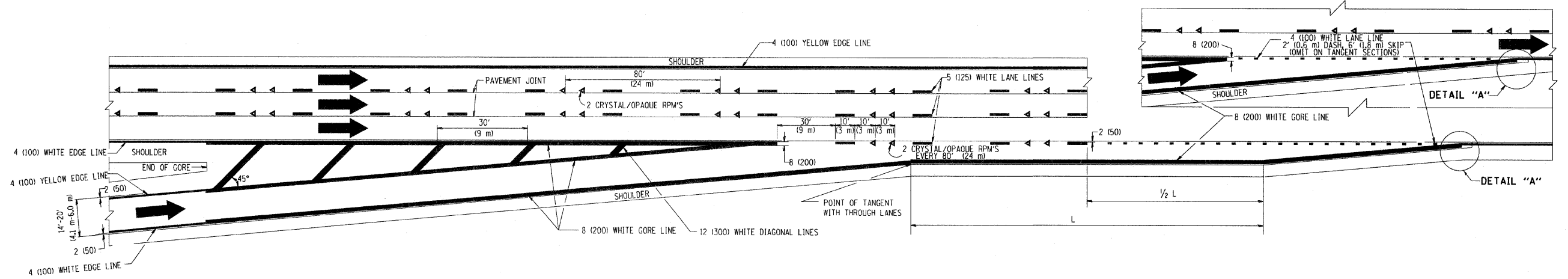

TYPICAL ENTRANCE RAMP PAVEMENT MARKINGS

FILE NAME = W:\diststd\22x34\1c12.dgn	USER NAME = gaglionobc	DESIGNED - D.W.S.	REVISED - A.H. 03-96	STATE OF ILLINOIS DEPARTMENT OF TRANSPORTATION	MULTI-LANE FREEWAY PAVEMENT MARKING DETAILS			F.A.P. RTE. 541	SECTION (X-R & T-13-A) RS-1	COUNTY LAKE	TOTAL SHEETS 29	SHEET NO. 23
PLOT SCALE = 50,000' / IN.	CHECKED -	REVISED - D.W.S. 07-96	REVISED - J.A.F. 02-06		SCALE: NONE	SHEET NO. 1 OF 2 SHEETS	STA.	TO STA.	TC-12			
PLOT DATE = 1/4/2008	DATE - 01-90	REVISED - S.P.B. 01-07	REVISED -		CONTRACT NO. 60G78							
FED. ROAD DIST. NO. 1 ILLINOIS FED. AID PROJECT												

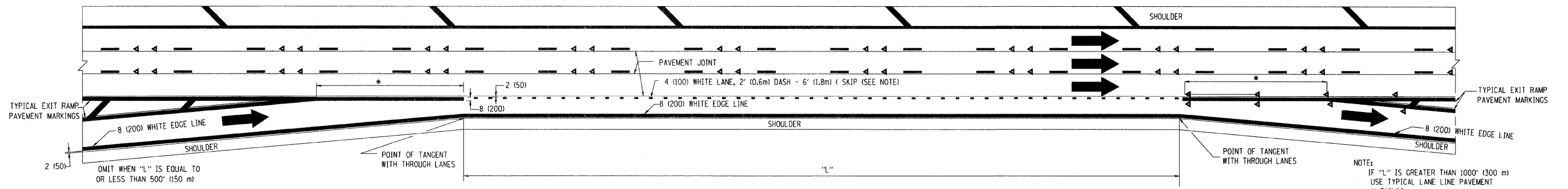

TYPICAL ENTRANCE/EXIT RAMP COMBINATION PAVEMENT MARKINGS

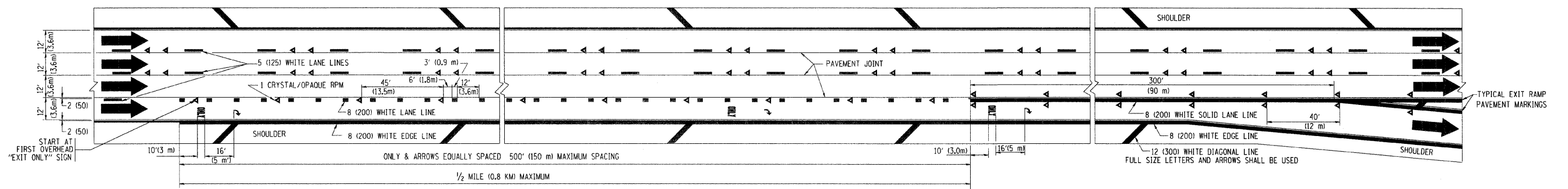

TYPICAL EXIT ONLY LANE PAVEMENT MARKINGS

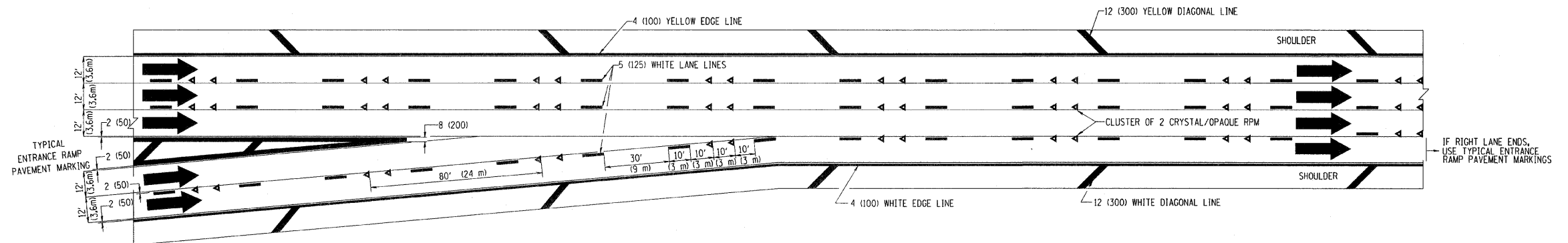

TYPICAL TWO LANE ENTRANCE RAMP PAVEMENT MARKINGS

FILE NAME = W:\diststd\22x34\td12.dgn	USER NAME = geglianob	DESIGNED - D.W.S.	REVISED - A.H. 03-96	STATE OF ILLINOIS DEPARTMENT OF TRANSPORTATION	MULTI-LANE FREEWAY PAVEMENT MARKING DETAILS			F.A.P. RTE. 541	SECTION (X-R & T-13-A) RS-1	COUNTY LAKE	TOTAL SHEETS 29	SHEET NO. 24
	PLOT SCALE = 50,000' / IN.	CHECKED -	REVISED - J.A.F. 02-06					TC-12				CONTRACT NO. 60G78
	PLOT DATE = 1/4/2008	DATE - 01-90	REVISED - S.P.B. 01-07					FED. ROAD DIST. NO. 1 ILLINOIS FED. AID PROJECT				
								SCALE: NONE	SHEET NO. 2 OF 2 SHEETS	STA. TO STA.		

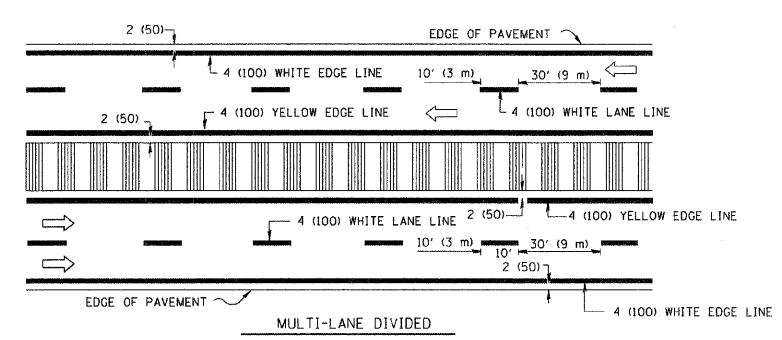
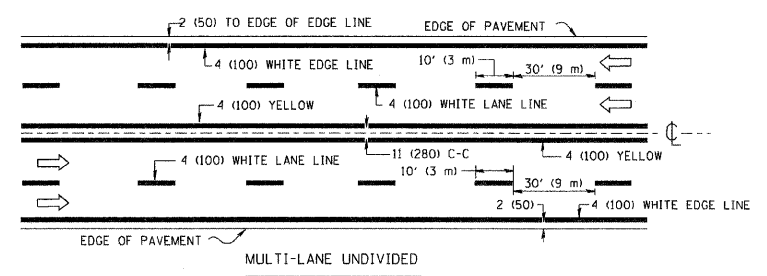
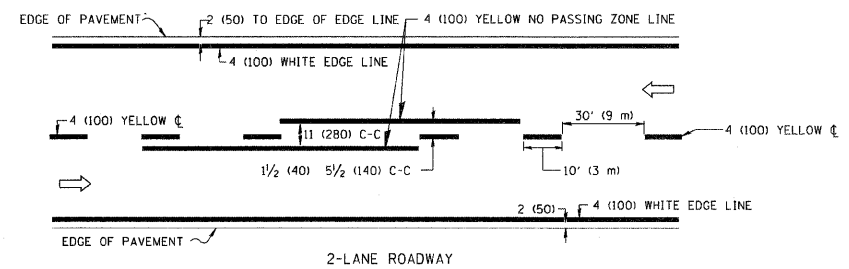

NOTE: MEDIANS WITH BARRIER CURB DO NOT REQUIRE AN EDGE LINE

TYPICAL LANE AND EDGE LINE MARKING

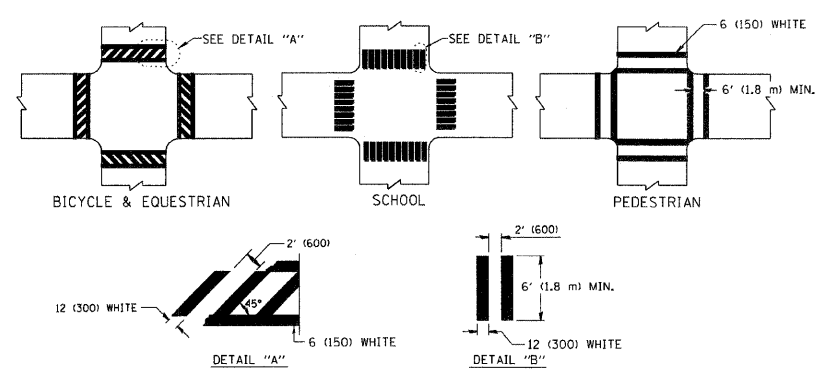

TYPICAL CROSSWALK MARKING

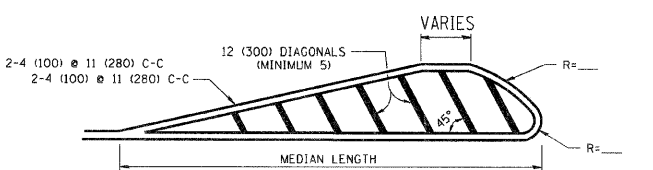
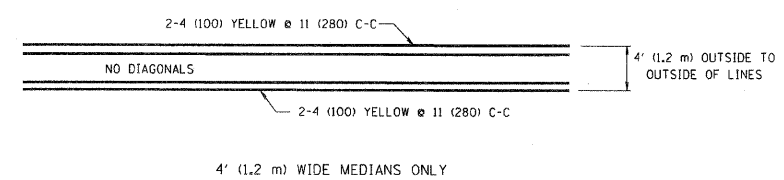

FOR MEDIAN LENGTHS WHERE DIAGONAL SPACING CANNOT BE ATTAINED, USE 5 (FIVE) EQUALLY SPACED DIAGONAL LINES.
 DIAGONAL LINE SPACING: 50' (15 m) C-C (LESS THAN 30MPH (50 km/h))
 75' (25 m) C-C 30MPH (50 km/h) TO 45MPH (70 km/h)
 150' (45 m) C-C (OVER 45MPH (70 km/h))

MEDIANS OVER 4' (1.2 m) WIDE

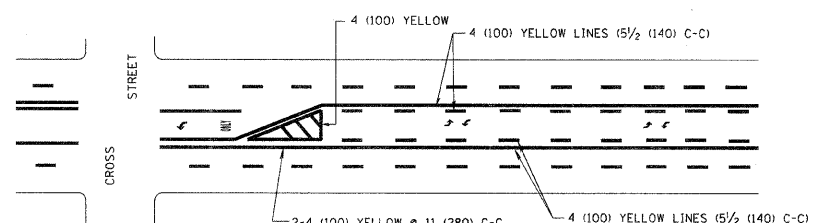

A MINIMUM OF TWO PAIRS OF TURN ARROWS SHALL BE USED, WHITE IN COLOR. ADDITIONAL PAIRS SHALL BE PLACED AT 200' (60 m) TO 300' (90 m) INTERVALS.

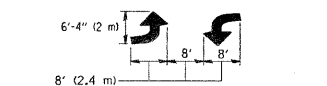

TYPICAL PAINTED MEDIAN MARKING

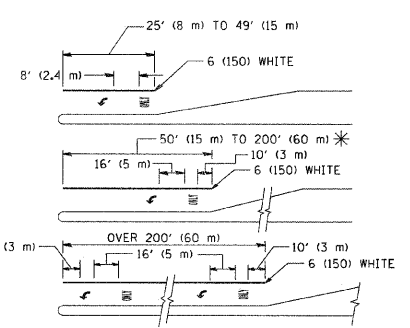

FULL SIZE LETTERS 8' (2.4 m) AND ARROWS SHALL BE USED.
 AREA = 15.6 SQ. FT. (1.5 m²) ONLY AREA = 20.8 SQ. FT. (1.9 m²)
 * TURN LANES IN EXCESS OF 400' (120 m) IN LENGTH MAY HAVE AN ADDITIONAL SET OF ARROW - "ONLY" INSTALLED MIDWAY BETWEEN THE OTHER TWO SETS OF ARROW - "ONLY".

TYPICAL LEFT (OR RIGHT) TURN LANE

TYPICAL TURN LANE MARKING

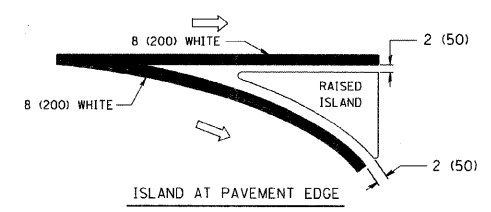
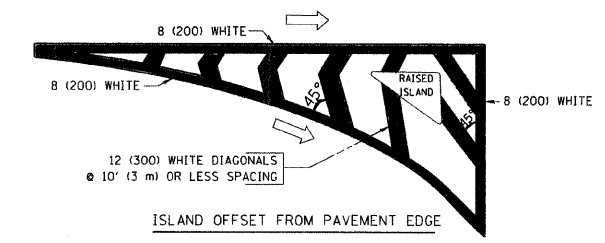

TYPICAL ISLAND MARKING

TYPE OF MARKING	WIDTH OF LINE	PATTERN	COLOR	SPACING / REMARKS
CENTERLINE ON 2 LANE PAVEMENT	4 (100)	SKIP-DASH	YELLOW	10' (3 m) LINE WITH 30' (9 m) SPACE
CENTERLINE ON MULTI-LANE UNDIVIDED PAVEMENT	2 @ 4 (100)	SOLID	YELLOW	11 (280) C-C
NO PASSING ZONE LINES: FOR ONE DIRECTION FOR BOTH DIRECTIONS	4 (100) 2 @ 4 (100)	SOLID SOLID	YELLOW YELLOW	5 1/2 (140) C-C FROM SKIP-DASH CENTERLINE 11 (280) C-C OMIT SKIP-DASH CENTERLINE BETWEEN
LANE LINES	4 (100) 5 (125) ON FREEWAYS	SKIP-DASH SKIP-DASH	WHITE WHITE	10' (3 m) LINE WITH 30' (9 m) SPACE
DOTTED LINES (EXTENSIONS OF CENTER, LANE OR TURN LANE MARKINGS)	SAME AS LINE BEING EXTENDED	SKIP-DASH	SAME AS LINE BEING EXTENDED	2' (600) LINE WITH 6' (1.8 m) SPACE
EDGE LINES	4 (100)	SOLID	YELLOW-LEFT WHITE-RIGHT	OUTLINE MOUNTABLE MEDIANS IN YELLOW. EDGE LINES ARE NOT USED NEXT TO BARRIER CURB
TURN LANE MARKINGS	6 (150) LINE; FULL SIZE LETTERS & SYMBOLS (8' (2.4m))	SOLID	WHITE	SEE TYPICAL TURN LANE MARKING DETAIL
TWO WAY LEFT TURN MARKING	2 @ 4 (100) EACH DIRECTION 8' (2.4m) LEFT ARROW	SKIP-DASH AND SOLID IN PAIRS	YELLOW WHITE	10' (3 m) LINE WITH 30' (9 m) SPACE FOR SKIP-DASH; 5 1/2 (140) C-C BETWEEN SOLID LINE AND SKIP-DASH LINE SEE TYPICAL TWO-WAY LEFT TURN MARKING DETAIL
CROSSWALK LINES (PEDESTRIAN) A. DIAGONALS (BIKE & EQUESTRIAN) B. LONGITUDINAL BARS (SCHOOL)	2 @ 6 (150) 12 (300) @ 45° 12 (300) @ 90°	SOLID SOLID SOLID	WHITE WHITE WHITE	NOT LESS THAN 6' (1.8 m) APART 2' (600) APART 2' (600) APART SEE TYPICAL CROSSWALK MARKING DETAILS.
STOP LINES	24 (600)	SOLID	WHITE	PLACE 4' (1.2 m) IN ADVANCE OF AND PARALLEL TO CROSSWALK, IF PRESENT. OTHERWISE, PLACE AT DESIRED STOPPING POINT. PARALLEL TO CROSSROAD CENTERLINE, WHERE POSSIBLE
PAINTED MEDIANS	2 @ 4 (100) WITH 12 (300) DIAGONALS @ 45° NO DIAGONALS USED FOR 4' (1.2 m) WIDE MEDIANS	SOLID	YELLOW; TWO WAY TRAFFIC WHITE; ONE WAY TRAFFIC	11 (280) C-C FOR THE DOUBLE LINE SEE TYPICAL PAINTED MEDIAN MARKING.
GORE MARKING AND CHANNELIZING LINES	8 (200) WITH 12 (300) DIAGONALS @ 45°	SOLID	WHITE	DIAGONALS: 15' (4.5 m) C-C (LESS THAN 30MPH (50 km/h)) 20' (6 m) C-C 30MPH (50 km/h) TO 45MPH (70 km/h) 30' (9 m) C-C (OVER 45MPH (70 km/h))
RAILROAD CROSSING	24 (600) TRANSVERSE LINES; "RR" 15' (4.5 m) LINE FOR "X"	SOLID	WHITE	SEE STATE STANDARD 780001 AREA OF "R"=3.6 SQ. FT. (0.33 m ²) EACH "X"=54.0 SQ. FT. (5.0 m ²)
SHOULDER DIAGONALS	12 (300) @ 45°	SOLID	WHITE - RIGHT YELLOW - LEFT	50' (15 m) C-C (LESS THAN 30MPH (50 km/h)) 75' (25 m) C-C (30 MPH (50 km/h) TO 45MPH (70 km/h)) 150' (45 m) C-C (OVER 45MPH (70 km/h))

FOR FURTHER DETAILS ON PAVEMENT MARKING REFER TO STANDARD SPECIFICATIONS FOR ROAD AND BRIDGE CONSTRUCTION AND STATE STANDARD 780001.



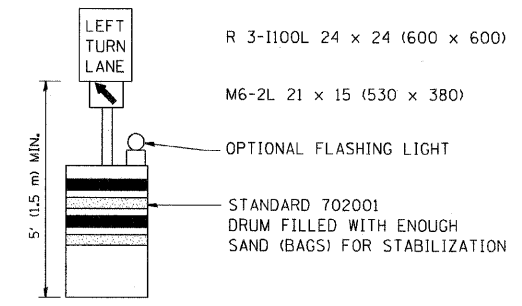
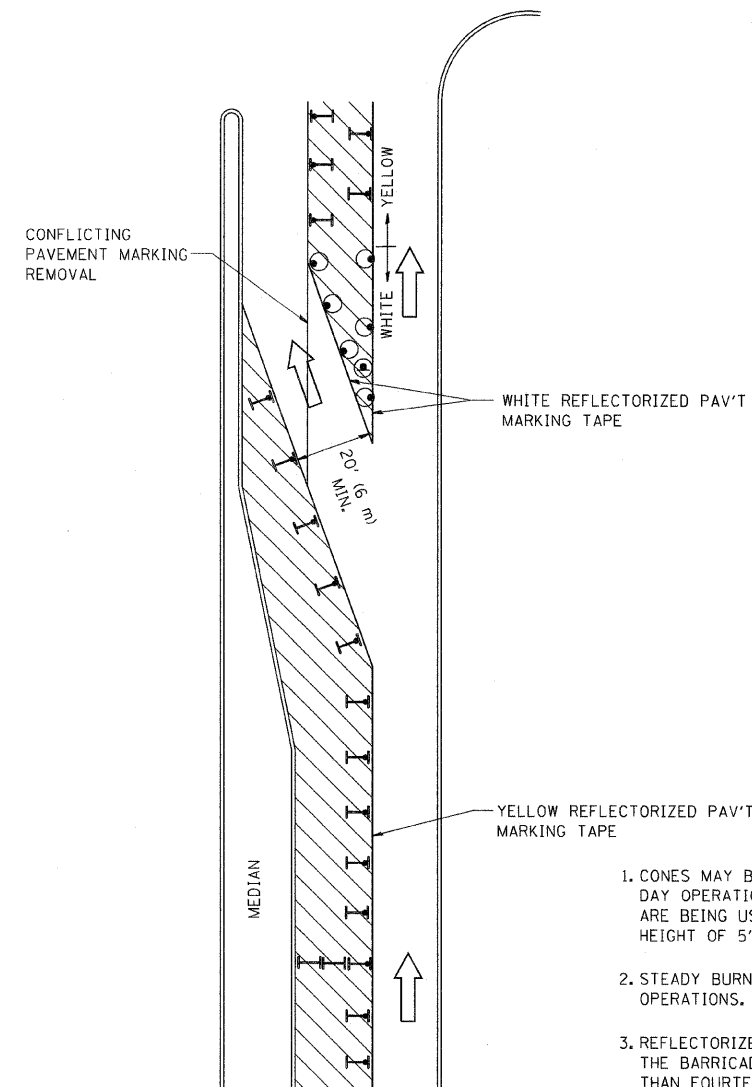



All dimensions are in inches (millimeters) unless otherwise shown.

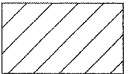

GENERAL NOTES

1. CONES MAY BE SUBSTITUTED FOR BARRICADES OR DRUMS AT HALF THE SPACING DURING DAY OPERATIONS. CONES SHALL BE A MINIMUM OF 28 (710) IN HEIGHT. WHEN CONES ARE BEING USED, THE "LEFT TURN LANE" SIGN MAY BE SKID MOUNTED AT A MINIMUM HEIGHT OF 5' (1.5 m).
2. STEADY BURNING LIGHTS WILL NOT BE REQUIRED ON BARRICADES OR DRUMS FOR DAY OPERATIONS. ALL LIGHTS SHALL BE MONODIRECTIONAL.
3. REFLECTORIZED TEMPORARY PAVEMENT MARKING TAPE SHALL BE PLACED THROUGHOUT THE BARRICADED AREA OF EACH TURN BAY WHERE THE CLOSURE TIME IS GREATER THAN FOURTEEN DAYS.
4. THIS APPLICATION ALSO APPLIES WHEN WORK IS BEING PERFORMED IN THE RIGHT LANE(S) AND THE RIGHT TURN BAY IS TO REMAIN OPEN. UNDER THIS CONDITION, "RIGHT TURN LANE" R3-100 24 x 24 (600 x 600) AND M6-2R 21 x 15 (530 x 380) SHALL BE USED.
5. THESE CONTROLS SHALL SUPPLEMENT MAINLINE TRAFFIC CONTROL FOR LANE CLOSURES.
6. LONGITUDINAL DIMENSIONS MAY BE ADJUSTED TO FIT FIELD CONDITIONS.
7. FORM BT 725 IS REQUIRED.
8. TRAFFIC CONTROL AND PROTECTION AT TURN BAYS (TO REMAIN OPEN TO TRAFFIC) SHALL BE INCLUDED IN THE COST SPECIFIED TRAFFIC CONTROL STANDARDS OR ITEMS.

LEGEND

-  WORK AREA
-  LANE OPEN TO TRAFFIC
-  TYPE I OR II BARRICADE WITH STEADY BURN LIGHT
-  DRUM WITH STEADY BURN LIGHT
-  DRUM WITH SIGN (WITH OPTIONAL FLASHING LIGHT) SEE DETAIL
-  TYPE I OR II CHECK BARRICADE WITH FLASHING LIGHT

All dimensions are in inches (millimeters) unless otherwise shown.

FILE NAME = W:\diststd\22x34\td14.dgn	USER NAME = goglionobt	DESIGNED -	REVISED -T. RAMMACHER 09-08-94
		DRAWN -	REVISED - A. HOUSEH 11-07-95
	PLOT SCALE = 50.0000 "/ IN.	CHECKED -	REVISED - A. HOUSEH 10-12-96
	PLOT DATE = 1/4/2008	DATE -	REVISED -T. RAMMACHER 01-06-00

**STATE OF ILLINOIS
DEPARTMENT OF TRANSPORTATION**

**TRAFFIC CONTROL AND PROTECTION AT TURN BAYS
(TO REMAIN OPEN TO TRAFFIC)**

SCALE: NONE SHEET NO. 1 OF 1 SHEETS STA. TO STA.

F.A.P. RTE. 541	SECTION (X-R & T-13-A) RS-1	COUNTY LAKE	TOTAL SHEETS 29	SHEET NO. 26
TC-14		CONTRACT NO. 60G78		
FED. ROAD DIST. NO. 1 ILLINOIS FED. AID PROJECT				

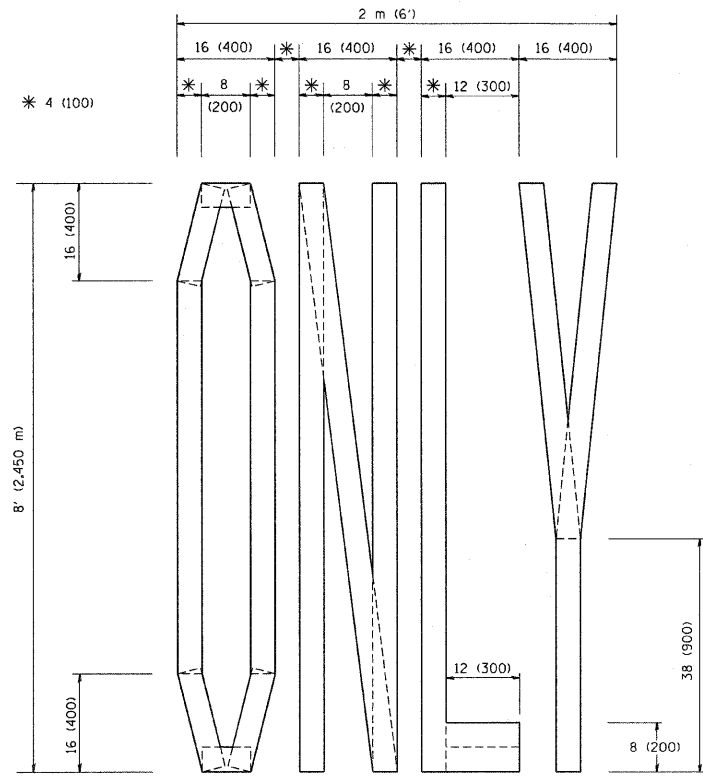

QUANTITY
 4 (100) LINE = 64.1 ft. (19.7 m)
 21.1 sq. ft. (1.97 sq. m)

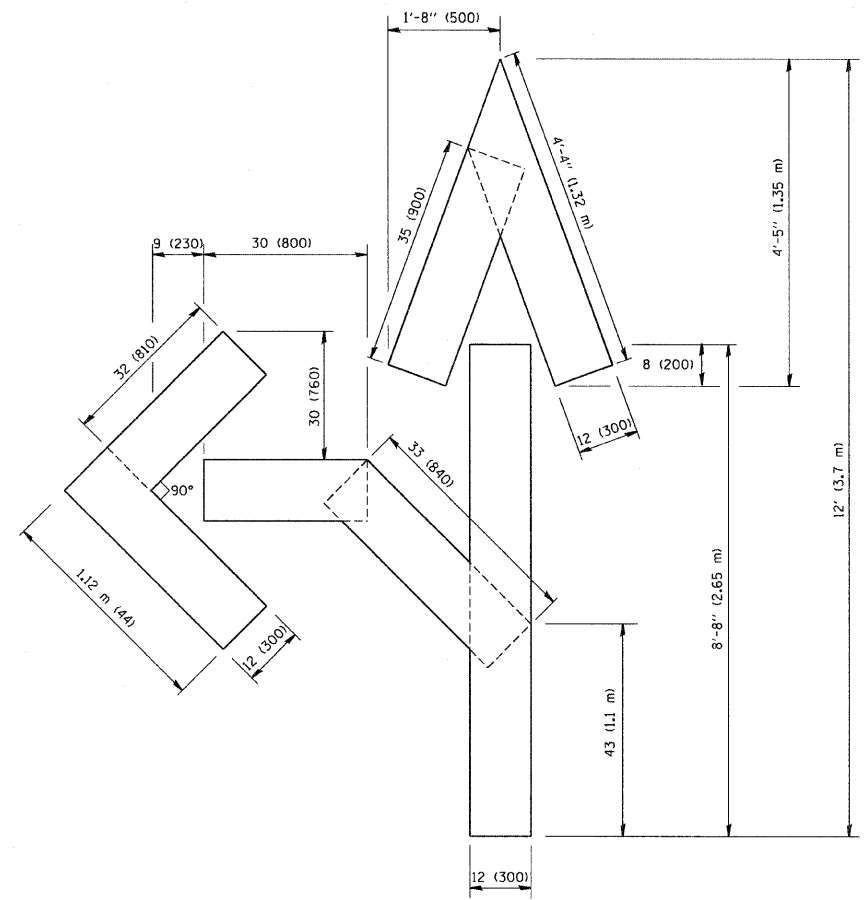

QUANTITY
 4 (100) LINE = 82.5 ft. (25.3 m)
 27.5 sq. ft. (2.53 sq. m)

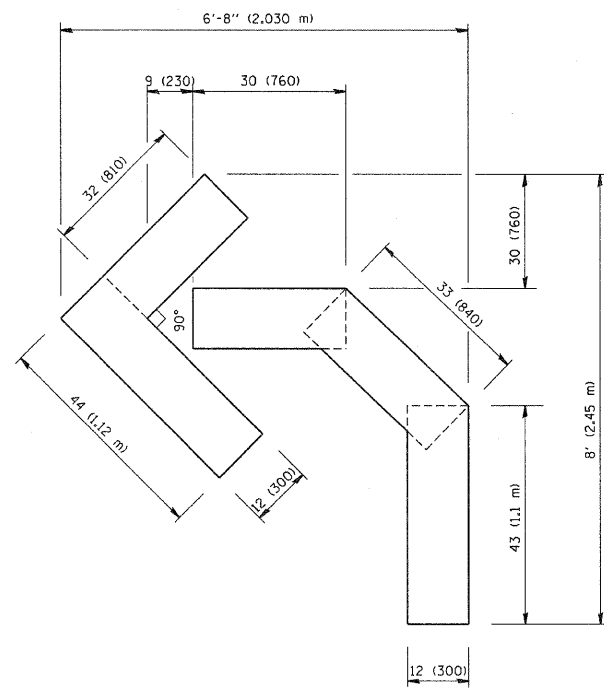

QUANTITY
 4 (100) LINE = 45.5 ft. (13.9 m)
 15.2 sq. ft. (1.39 sq. m)

All dimensions are in inches (millimeters) unless otherwise shown.

FILE NAME = W:\diststd\22x34\tc16.dgn	USER NAME = gaglianob	DESIGNED -	REVISED -T. RAMMACHER 06-05-96
		DRAWN -	REVISED -T. RAMMACHER 11-04-97
	PLOT SCALE = 50.0000 "/ IN.	CHECKED -	REVISED -T. RAMMACHER 03-02-98
	PLOT DATE = 1/4/2008	DATE - 09-18-94	REVISED -E. GOMEZ 08-28-00

STATE OF ILLINOIS
 DEPARTMENT OF TRANSPORTATION

PAVEMENT MARKING LETTERS AND SYMBOLS
 FOR TRAFFIC STAGING

SCALE: NONE SHEET NO. 1 OF 1 SHEETS STA. TO STA.

F.A.P. RTE. 541	SECTION (X-R & T-13-A) RS-1	COUNTY LAKE	TOTAL SHEETS 29	SHEET NO. 27
TC-16		CONTRACT NO. 60G78		
FED. ROAD DIST. NO. 1 ILLINOIS FED. AID PROJECT				

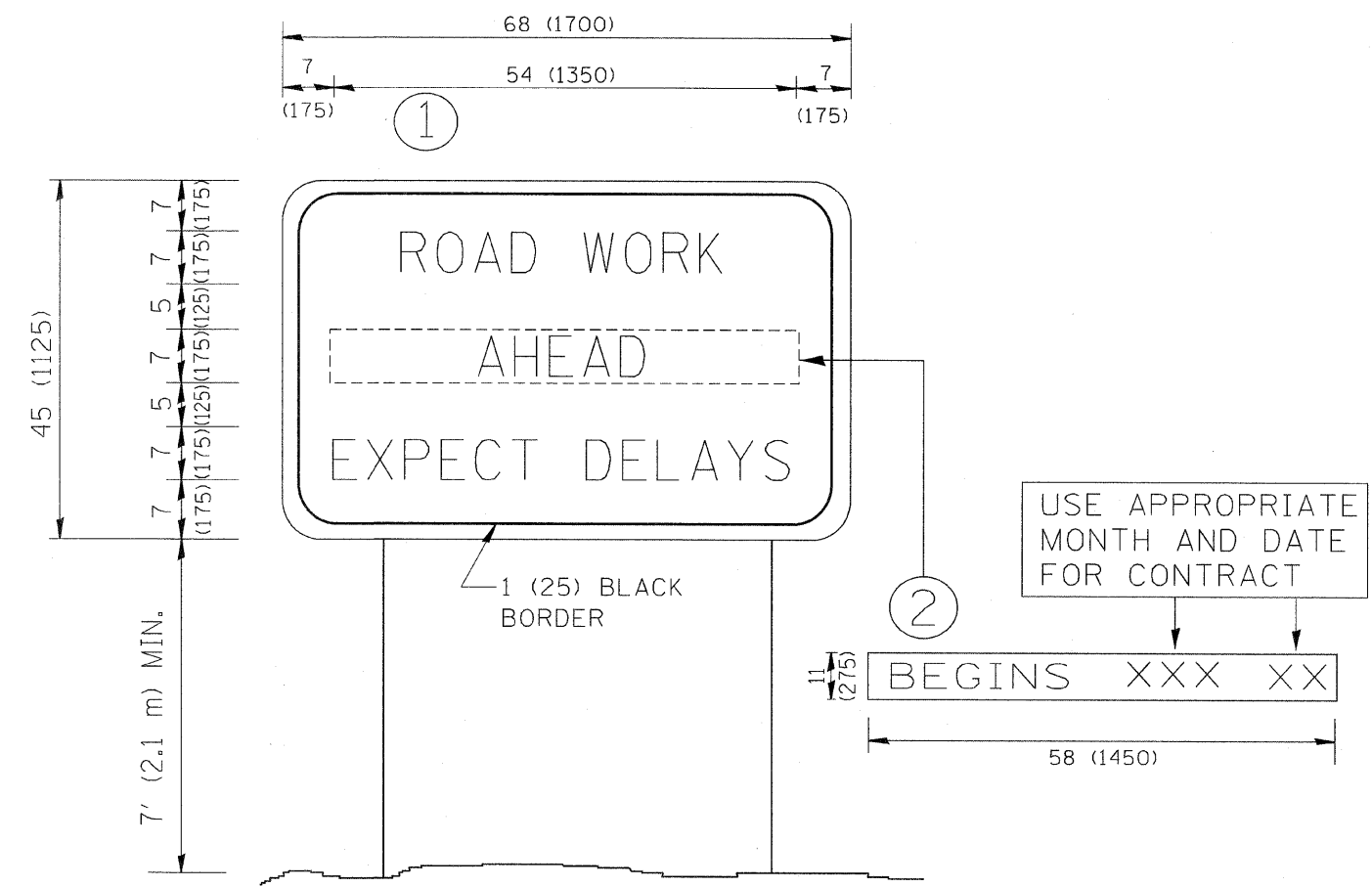

NOTES:

1. USE BLACK LETTERING ON ORANGE BACKGROUND.
2. ERECT SIGNS IN ADVANCE OF THE LOCATION FOR THE "ROAD CONSTRUCTION AHEAD" SIGN AT LOCATIONS AS DIRECTED BY THE ENGINEER.
3. ERECT SIGN ① WITH INSTALLED PANEL ② ONE WEEK PRIOR TO THE START OF CONSTRUCTION.
4. REMOVE PANEL ② SOON AFTER THE START OF CONSTRUCTION.
5. SEE SPECIAL PROVISION FOR "TEMPORARY INFORMATION SIGNING" FOR ADDITIONAL INFORMATION.
6. ONE SIGN ASSEMBLY EQUALS 25.70 SQ. FT. (2.3 SQ. M.)
7. SHALL BE PAID FOR AS TEMPORARY INFORMATION SIGNING.

ALL DIMENSIONS ARE IN INCHES (MILLIMETERS) UNLESS OTHERWISE SHOWN.

FILE NAME = W:\diststd\22x34\to22.dgn	USER NAME = gaglianobt	DESIGNED -	REVISED - R. MIRS 09-15-97	STATE OF ILLINOIS DEPARTMENT OF TRANSPORTATION	ARTERIAL ROAD INFORMATION SIGN			F.A.P. RTE.	SECTION	COUNTY	TOTAL SHEETS	SHEET NO.
	PLOT SCALE = 50,000' / IN.	DRAWN -	REVISED - R. MIRS 12-11-97		541	(X-R & T-13-A) RS-1	LAKE	29	28			
	PLOT DATE = 1/4/2008	CHECKED -	REVISED - T. RAMMACHER 02-02-99		TC-22				CONTRACT NO. 60G78			
		DATE -	REVISED - C. JUCIUS 01-31-07		SCALE: NONE	SHEET NO. 1 OF 1 SHEETS	STA.	TO STA.	FED. ROAD DIST. NO. 1 ILLINOIS FED. AID PROJECT			

LOOPS NEXT TO SHOULDERS

PROVIDE A PAVEMENT REPLACEMENT
NOTE WHICH SHOULD EQUAL
3' (900 mm) X WIDTH OF
PAVED SHOULDER.

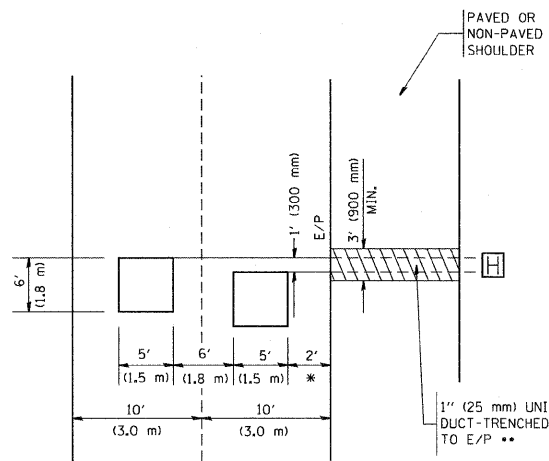

* = (600 mm)

** UNIT DUCT IS TO BE SHOWN ON PLAN SHEETS
BUT SHALL NOT BE INCLUDED IN THE PAY ITEMS.

**LEFT TURN LANES WITH MEDIANS
VOLUME DENSITY ("FAR OUT" DETECTION)
ON SAME APPROACH
(PROTECTED / PERMITTED LEFT TURN PHASING)**

HANDHOLE LOCATION MAY
VARY DEPENDING ON GEOMETRICS
AND DESIGN OF TRAFFIC SIGNALS.
HEAVY-DUTY HANDHOLES TO BE
USED WHEN THE MEDIAN IS
MOUNTABLE. REFER TO STANDARD
814001 TO ENSURE THAT HANDHOLE
FITS IN MEDIAN.

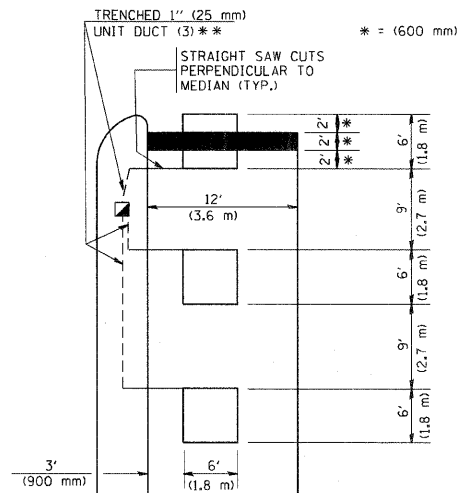

** UNIT DUCT IS TO BE SHOWN ON PLAN SHEETS
BUT SHALL NOT BE INCLUDED IN THE PAY ITEMS.

NOTE: DUAL LEFT TURNS NOT SHOWN REFER TO
PLAN SHEET FOR DETECTOR LOOP REPLACEMENT

**LEFT TURN LANES WITHOUT MEDIANS
VOLUME DENSITY ("FAR OUT" DETECTION)
ON SAME APPROACH
(PROTECTED / PERMITTED LEFT TURN PHASING)**

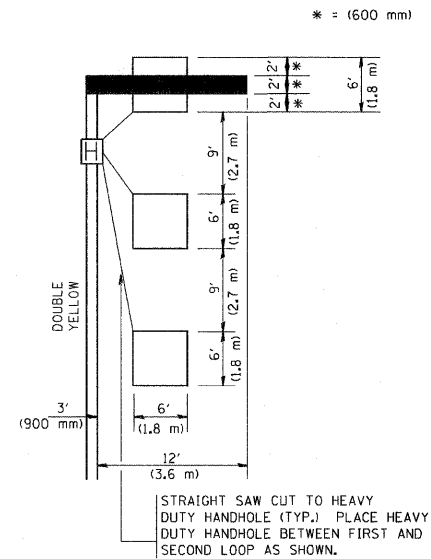

NOTE: DUAL LEFT TURNS NOT SHOWN REFER TO
PLAN SHEET FOR DETECTOR LOOP REPLACEMENT

**ARTERIAL-VOLUME DENSITY ("FAR OUT" DETECTION)
CROSS STREET-VOLUME DENSITY ("FAR OUT" DETECTION)**

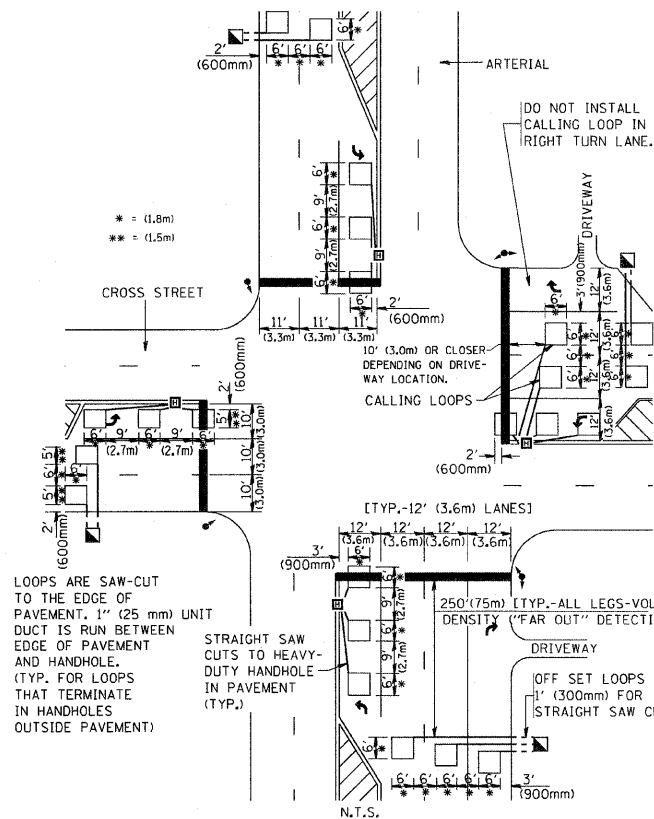

DETAIL 1
N.T.S.

**ARTERIAL-VOLUME DENSITY ("FAR OUT" DETECTION)
CROSS STREET-NON VOLUME DENSITY ("UPTIGHT" PRESENCE DETECTION)**

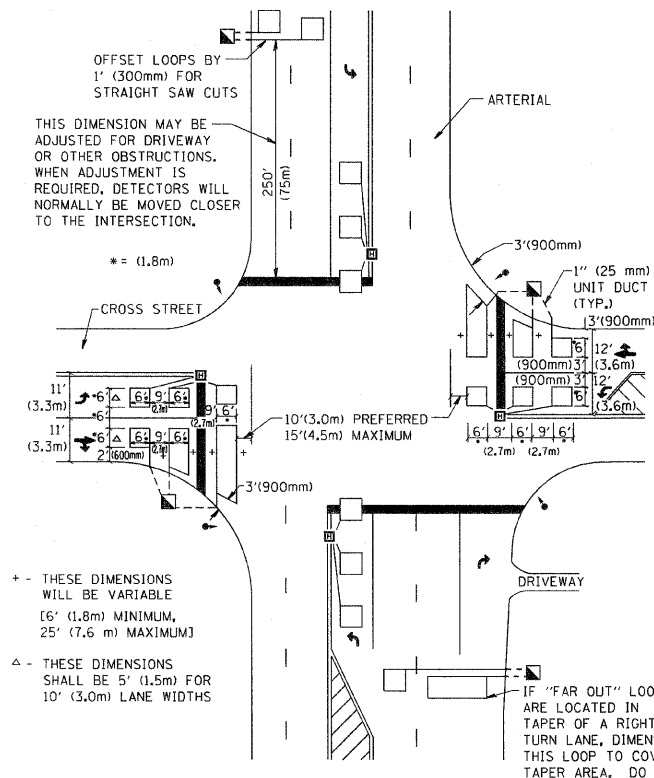

DETAIL 2
N.T.S.

NOTES:

VEHICLES LOOP DETECTORS

- * ALL LEAD IN CABLE SHALL BE TWO CONDUCTOR NO. 14 TWISTED, SHIELDED.
- * EACH DETECTOR LOOP SHALL HAVE ITS OWN SAW CUT FROM THE LOOP TO THE EDGE OF PAVEMENT OR TO A HANDHOLE IN THE PAVEMENT.
- * EACH DETECTOR LOOP SHALL HAVE ITS OWN ONE INCH (25 mm) UNIT DUCT BETWEEN THE EDGE OF PAVEMENT AND THE FIRST HANDHOLE OR JUNCTION BOX. EACH UNIT DUCT RUN SHALL BE SHOWN ON THE PLANS BY THE DESIGNER, BUT SHALL NOT BE PAID FOR SEPARATELY. THIS ITEM IS INCIDENTAL TO THE PAY ITEM FOR DETECTOR LOOPS.
- * ONE DIMENSION OF ALL DETECTOR LOOPS SHALL BE SIX FEET (1.8 m)
- * EACH LANE OF NON-LOCKING, PRESENCE DETECTION AND EACH LANE OF A DOUBLE LEFT TURN LANE REQUIRES A SEPARATE INDUCTIVE LOOP DETECTOR AND LEAD IN CABLE.
- * WHEN NON-LOCKING, PRESENCE DETECTION IS USED, MORE THAN ONE LOOP PER LANE IS REQUIRED BEHIND THE STOP BAR (i.e. 1-1/2, 1-3/4, 2).
- * WHEN SYSTEM LOOPS ARE REQUIRED ON AN APPROACH OF AN INTERSECTION, THE LOOPS USED FOR VOLUME DENSITY AND INTERSECTION TIMING SHALL ALSO BE USED AS SYSTEM DETECTORS. EACH ONE OF THESE TYPE OF LOOPS REQUIRES A SEPARATE TWO CONDUCTOR NO. 14 TWISTED SHIELDED CABLE AND A SEPARATE INDUCTIVE LOOP DETECTOR WHEN NEW CONTROLLERS ARE UTILIZED. THE DESIGNER SHALL LABEL THESE TYPES OF LOOPS AS "INTERSECTION AND SAMPLING (SYSTEM) DETECTORS" ON THE SIGNAL LAYOUT, THE INTERCONNECT PLAN AND THE SYSTEM CABLE PLAN. WHEN AN EXISTING CONTROLLER IS UTILIZED FOR THIS TYPE OF DETECTION, THE PAY ITEM "INDUCTIVE LOOP DETECTOR WITH SYSTEM OUTPUT" SHOULD BE USED.

PLACEMENT OF DETECTORS

THE FOLLOWING FIGURES REPRESENT THE MOST COMMON DETECTOR LOOP LOCATIONS AND SIZES. ADJUSTMENTS WILL BE NECESSARY FOR SPECIFIC GEOMETRIC CONSIDERATIONS.

LOCATIONS AND DIMENSIONS OF DETECTOR LOOPS ARE REQUIRED ON ALL SIGNAL LAYOUT PLAN SHEETS.

"FAR OUT" DETECTION REFERS TO LOCKING, PRESENCE TYPE DETECTION LOCATED IN THRU LANES, RIGHT TURN LANES, AND RIGHT TURN LANE TAPER AREAS (IF APPLICABLE), USUALLY 250' (75 m) IN ADVANCE OF STOP BARS. "UPTIGHT" DETECTION REFERS TO NON-LOCKING PRESENCE TYPE DETECTION LOCATED IN ALL LANES AND 10'-15' (3.0 m-4.5 m) BEHIND THE CROSSING STREET'S EDGE OF PAVEMENT EXTENDED.

NOTE:

ALL DETAILS AND NOTES SHOWN ARE FROM THE I.D.O.T. DISTRICT 1 TRAFFIC SIGNAL DESIGN GUIDELINES DATED JANUARY 1995

THIS DRAWING HAS BEEN PREPARED TO ASSIST THE RESIDENT ENGINEER FOR ALL ROADWAY RESURFACING OR S.M.A.R.T. PROJECTS WHERE THE DIMENSIONS ARE NOT SHOWN ON THE PLANS AND THE FINAL LOCATIONS FOR CROSSWALKS OR STOP BARS ARE NOT DETERMINED.

FILE NAME = W:\diststd\22x34\ts07.dgn	USER NAME = geglanoib	DESIGNED -	REVISED -
		DRAWN -	REVISED -
		CHECKED - R.K.F.	REVISED -
		DATE -	REVISED -

**STATE OF ILLINOIS
DEPARTMENT OF TRANSPORTATION**

**DISTRICT 1 - DETECTOR LOOP INSTALLATION
DETAILS FOR ROADWAY RESURFACING**

SCALE: NONE SHEET NO. 1 OF 1 SHEETS STA. TO STA.

F.A.P. RTE. 541	SECTION (X-R & T-13-A) RS-1	COUNTY LAKE	TOTAL SHEETS 29	SHEET NO. 29
TS-07		CONTRACT NO. 60G78		
FED. ROAD DIST. NO. 1 ILLINOIS FED. AID PROJECT				