

# **BID PROPOSAL INSTRUCTIONS**

**ABOUT IDOT PROPOSALS:** All proposals are potential bidding proposals. Each proposal contains all certifications and affidavits, a proposal signature sheet and a proposal bid bond.

## **PREQUALIFICATION**

Any contractor who desires to become pre-qualified to bid on work advertised by IDOT must submit the properly completed pre-qualification forms to the Bureau of Construction no later than 4:30 p.m. prevailing time twenty-one days prior to the letting of interest. This pre-qualification requirement applies to first time contractors, contractors renewing expired ratings, contractors maintaining continuous pre-qualification or contractors requesting revised ratings. To be eligible to bid, existing pre-qualification ratings must be effective through the date of letting.

## **WHO CAN BID ?**

Bids will be accepted from only those companies that request and receive written Authorization to Bid from IDOT's Central Bureau of Construction.

## **REQUESTS FOR AUTHORIZATION TO BID**

Contractors wanting to bid on items included in a particular letting must submit the properly completed "Request for Authorization to Bid/or Not For Bid Status" (BDE 124) and the ORIGINAL "Affidavit of Availability" (BC 57) to the proper office no later than 4:30 p.m. prevailing time, three (3) days prior to the letting date.

## **WHAT CONSTITUTES WRITTEN AUTHORIZATION TO BID?**

When a prospective prime bidder submits a "Request for Authorization to Bid/or Not For Bid Status"(BDE 124) he/she must indicate at that time which items are being requested For Bidding purposes. Only those items requested For Bidding will be analyzed. After the request has been analyzed, the bidder will be issued an **Authorization to Bid or Not for Bid Report**, approved by the Central Bureau of Construction and the Chief Procurement Officer that indicates which items have been approved For Bidding. If **Authorization to Bid** cannot be approved, the **Authorization to Bid or Not for Bid Report** will indicate the reason for denial.

## **ABOUT AUTHORIZATION TO BID**

Firms that have not received an Authorization to Bid or Not For Bid Report within a reasonable time of complete and correct original document submittal should contact the Department as to the status. Firms unsure as to authorization status should call the Prequalification Section of the Bureau of Construction at the number listed at the end of these instructions.

## **ADDENDA AND REVISIONS**

It is the bidder's responsibility to determine which, if any, addenda or revisions pertain to any project they may be bidding. Failure to incorporate all relevant addenda or revisions may cause the bid to be declared unacceptable.

Each addendum or revision will be included with the Electronic Plans and Proposals. Addenda and revisions will also be placed on the Addendum/Revision Checklist and each subscription service subscriber will be notified by e-mail of each addendum and revision issued.

The Internet is the Department's primary way of doing business. The subscription service emails are an added courtesy the Department provides. It is suggested that bidders check IDOT's website at <http://www.idot.illinois.gov/doing-business/procurements/construction-services/construction-bulletins/transportation-bulletin/index#TransportationBulletin> before submitting final bid information.

***IDOT IS NOT RESPONSIBLE FOR ANY E-MAIL FAILURES.***

Addenda questions may be directed to the Contracts Office at (217)782-7806 or [DOT.D&Econtracts@illinois.gov](mailto:DOT.D&Econtracts@illinois.gov)

Technical questions about downloading these files may be directed to Tim Garman at (217)524-1642 or [Timothy.Garman@illinois.gov](mailto:Timothy.Garman@illinois.gov).

## **STANDARD GUIDELINES FOR SUBMITTING PAPER BIDS**

- All pages should be single sided.
- Use the Cover Page that is provided in the Bid Proposal (posted on the IDOT Web Site) as the first page of your submitted bid. It has the item number in large bold type in the upper left-hand corner and lines provided for your company name and address in the upper right-hand corner.
- Do not use report covers, presentation folders or special bindings and do not staple multiple times on left side like a book. Use only 1 staple in the upper left hand corner. Make sure all elements of your bid are stapled together including the bid bond or guaranty check (if required).
- **Do not include any certificates of eligibility, your authorization to bid, Addendum Letters or affidavit of availability.**
- Do not include the Subcontractor Documentation with your bid (pages i – iii and pages a – g). This documentation is required only if you are awarded the project.
- Use the envelope cover sheet (provided with the proposal) as the cover for the proposal envelope.
- Do not rely on overnight services to deliver your proposal prior to 10 AM on letting day. It will not be read if it is delivered after 10 AM.
- Do not submit your Substance Abuse Prevention Program (SAPP) with your bid. If you are awarded the contract this form is to be submitted to the district engineer at the pre-construction conference.

## **BID SUBMITTAL CHECKLIST**

- Cover page** (the sheet that has the item number on it) – This should be the first page of your bid proposal, **followed by your bid (the Schedule of Prices/Pay Items)**. If you are using special software or CBID to generate your schedule of prices, do not include the blank pages of the schedule of prices that came with the proposal package.
- Page 4 (Item 9)** – Check “YES” if you will use a subcontractor(s) with an annual value over \$50,000. Include the subcontractor(s) name, address, general type of work to be performed and the dollar amount. If you will use subcontractor(s) but are uncertain who or the dollar amount; check “YES” but leave the lines blank.
- After page 4** – Insert the following documents: Cost Adjustments for Steel, Bituminous and Fuel (if applicable) and the Contractor Letter of Assent (if applicable). The general rule should be, if you don’t know where it goes, put it after page 4.
- Page 10 (Paragraph J)** – Check “YES” or “NO” whether your company has any business in Iran.
- Page 10 (Paragraph K)** – (Not applicable to federally funded projects) List the name of the apprenticeship and training program sponsor holding the certificate of registration from the US Department of Labor. If no applicable program exists, please indicate the work/job category. **Do not include certificates with your bid.** Keep the certificates in your office in case they are requested by IDOT.
- Page 11 (Paragraph L)** – Your State Board of Elections certificate of registration is no longer required with your bid.
- Page 11 (Paragraph M)** – Indicate if your company has hired a lobbyist in connection with the job for which you are submitting the bid proposal.
- Page 12 (Paragraph C)** – This is a work sheet to determine if a completed Form A is required. It is not part of the form and you do not need to make copies for each completed Form A.
- Pages 14-17 (Form A)** – One Form A (4 pages) is required for each applicable person in your company. Copies of the forms can be used and only need to be changed when the information changes. The certification signature and date must be original for each letting. **Do not staple the forms together.** If you answered “NO” to all of the questions in Paragraph C (page 12), complete the first section (page 14) with your company information and then sign and date the Not Applicable statement on page 17.
- Page 18 (Form B)** - If you check “YES” to having other current or pending contracts it is acceptable to use the phrase, “See Affidavit of Availability on file”. **Ownership Certification** (at the bottom of the page) - Check N/A if the Form A(s) you submitted accounts for 100 percent of the company ownership. Check YES if any percentage of ownership falls outside of the parameters that require reporting on the Form A. Checking NO indicates that the Form A(s) you submitted is not correct and you will be required to submit a revised Form A.
- Page 20 (Workforce Projection)** – Be sure to include the Duration of the Project. It is acceptable to use the phrase “Per Contract Specifications”.

- Proposal Bid Bond** – (Insert after the proposal signature page) Submit your Proposal Bid Bond (if applicable) using the current Proposal Bid Bond form provided in the proposal package. The Power of Attorney page should be stapled to the Proposal Bid Bond. If you are using an electronic bond, include your bid bond number on the Proposal Bid Bond and attach the Proof of Insurance printed from the Surety’s Web Site.
- Disadvantaged Business Utilization Plan and/or Good Faith Effort – Do Not Submit with Bid** The bidder shall submit a Disadvantaged Business Utilization Plan on completed Department forms SBE 2025 and 2026. (1) The final Utilization Plan must be submitted within five calendar days after the date of the letting. (2) To meet the five day requirement, the bidder may send the Utilization Plan electronically by scanning and sending to [DOT.DBE.UP@illinois.gov](mailto:DOT.DBE.UP@illinois.gov) or faxing to (217) 785-1524. The subject line must include the bid Item Number and the Letting date. The Utilization Plan should be sent as one .pdf file, rather than multiple files and emails for the same Item Number. It is the responsibility of the bidder to obtain confirmation of email or fax delivery.

Alternatively, the Utilization Plan may be sent by certified mail or delivery service within the five calendar day period. If a question arises concerning the mailing date of a Utilization Plan, the mailing date will be established by the U.S. Postal Service postmark on the certified mail receipt from the U.S. Postal Service or the receipt issued by a delivery service. It is the responsibility of the bidder to ensure the postmark or receipt date is affixed within the five days if the bidder intends to rely upon mailing or delivery to satisfy the submission day requirement. The Utilization Plan is to be submitted to:

Illinois Department of Transportation  
 Bureau of Small Business Enterprises  
 Contract Compliance Section  
 2300 South Dirksen Parkway, Room 319  
 Springfield, Illinois 62764

**The Bid Letting is now available in streaming Audio/Video from the IDOT Web Site.** A link to the stream will be placed on the main page of the current letting on the day of the Letting. The stream will not begin until 10 AM. The actual reading of the bids does not begin until approximately 10:30 AM.

Following the Letting, the As-Read Tabulation of Bids will be posted by the end of the day. You will find the link on the main Web page for the current letting.

**QUESTIONS: pre-letting up to execution of the contract**

Contractor pre-qualification .....	217-782-3413
Small Business, Disadvantaged Business Enterprise (DBE) .....	217-785-4611
Contracts, Bids, Letting process or Internet downloads .....	217-782-7806
Estimates Unit.....	217-785-3483
Aeronautics.....	217-785-8515
IDNR (Land Reclamation, Water Resources, Natural Resources).....	217-782-6302

**QUESTIONS: following contract execution**

Subcontractor documentation, payments .....	217-782-3413
Railroad Insurance .....	217-785-0275

# 54

RETURN WITH BID

Proposal Submitted By
Name
Address
City

## Letting June 10, 2016

### NOTICE TO PROSPECTIVE BIDDERS

This proposal can be used for bidding purposes by only those companies that request and receive written AUTHORIZATION TO BID from IDOT's Central Bureau of Construction.

**BIDDERS NEED NOT RETURN THE ENTIRE PROPOSAL**

# Notice to Bidders, Specifications, Proposal, Contract and Contract Bond



**Illinois Department  
of Transportation**

Springfield, Illinois 62764

**Contract No. 64L37  
WINNEBAGO County  
Section 102RS-3  
Route FAS 55  
District 2 Construction Funds**

PLEASE MARK THE APPROPRIATE BOX BELOW:

- A Bid Bond is included.
- A Cashier's Check or a Certified Check is included.
- An Annual Bid Bond is included or is on file with IDOT.

Plans Included  
Herein

Prepared by

S

Checked by

(Printed by authority of the State of Illinois)

**Page intentionally left blank**

RETURN WITH BID



PROPOSAL

TO THE DEPARTMENT OF TRANSPORTATION

1. Proposal of \_\_\_\_\_

\_\_\_\_\_

Taxpayer Identification Number (Mandatory) \_\_\_\_\_

For the improvement identified and advertised for bids in the Invitation for Bids as:

**Contract No. 64L37  
WINNEBAGO County  
Section 102RS-3  
Route FAS 55  
District 2 Construction Funds**

**This project consists of raised reflective pavement marker (RRPM) removal and replacement, Cape Seal application, temporary RRPM application and removal, paint and thermoplastic pavement marking removal and replacement for 6.47 miles on IL 70 from 0.20 miles south of IL 75 to the Pecatonica River.**

2. The undersigned bidder will furnish all labor, material and equipment to complete the above described project in a good and workmanlike manner as provided in the contract documents provided by the Department of Transportation. This proposal will become part of the contract and the terms and conditions contained in the contract documents will govern performance and payments.



**RETURN WITH BID**

6. **COMBINATION BIDS.** The undersigned bidder further agrees that if awarded the contract for the sections contained in the following combination, he/she will perform the work in accordance with the requirements of each individual contract comprising the combination bid specified in the schedule below, and that the combination bid shall be prorated against each section in proportion to the bid submitted for the same. If an error is found to exist in the gross sum bid for one or more of the individual sections included in a combination, the combination bid shall be corrected as provided in the specifications.

**When a combination bid is submitted, the schedule below must be completed in each proposal comprising the combination.**

**If alternate bids are submitted for one or more of the sections comprising the combination, a combination bid must be submitted for each alternate.**

**Schedule of Combination Bids**

Combination No.	Sections Included in Combination	Combination Bid	
		Dollars	Cents

7. **SCHEDULE OF PRICES.** The undersigned bidder submits herewith, in accordance with the rules and instructions, a schedule of prices for the items of work for which bids are sought. The unit prices bid are in U.S. dollars and cents, and all extensions and summations have been made. The bidder understands that the quantities appearing in the bid schedule are approximate and are provided for the purpose of obtaining a gross sum for the comparison of bids. If there is an error in the extension of the unit prices, the unit prices will govern. Payment to the contractor awarded the contract will be made only for actual quantities of work performed and accepted or materials furnished according to the contract. The scheduled quantities of work to be done and materials to be furnished may be increased, decreased or omitted as provided elsewhere in the contract.
8. **AUTHORITY TO DO BUSINESS IN ILLINOIS.** Section 20-43 of the Illinois Procurement Code (the Code) (30 ILCS 500/20-43) provides that a person (other than an individual acting as a sole proprietor) must be a legal entity authorized to transact business or conduct affairs in the State of Illinois prior to submitting the bid.
9. **EXECUTION OF CONTRACT:** The Department of Transportation will, in accordance with the rules governing Department procurements, execute the contract and shall be the sole entity having the authority to accept performance and make payments under the contract. Execution of the contract by the Chief Procurement Officer (CPO) or the State Purchasing Officer (SPO) is for approval of the procurement process and execution of the contract by the Department. Neither the CPO nor the SPO shall be responsible for administration of the contract or determinations respecting performance or payment there under except as otherwise permitted in the Code.

10. **The services of a subcontractor will be used.**

Check box Yes   
 Check box No

For known subcontractors with subcontracts with an annual value of more than \$50,000, the contract shall include their name, address, general type of work to be performed, and the dollar allocation for each subcontractor.  
 (30 ILCS 500/20-120)

---



---



ILLINOIS DEPARTMENT OF TRANSPORTATION  
 SCHEDULE OF PRICES  
 CONTRACT  
 NUMBER -

64L37

State Job # - C-92-075-16

Project Number

Route

County Name - WINNEBAGO - -

FAS 55

Code - 201 - -

District - 2 - -

Section Number - 102RS-3

Item Number	Pay Item Description	Unit of Measure	Quantity	x	Unit Price	=	Total Price
X0326218	FIBR MOD ASP CRK SEAL	FOOT	11,386.000				
X0326219	BUMP REMOVAL	EACH	100.000				
X7810400	TEMP RAIS PAV MK	EACH	9,781.000				
Z0040315	PILOT CAR	DAY	4.000				
Z0064265	CAPE SEAL	SQ YD	97,132.000				
40600525	LEV BIND HM N50	TON	11.000				
67100100	MOBILIZATION	L SUM	1.000				
70100450	TRAF CONT-PROT 701201	L SUM	1.000				
70100460	TRAF CONT-PROT 701306	L SUM	1.000				
70300100	SHORT TERM PAVT MKING	FOOT	4,993.000				
70300150	SHRT TRM PAVT MK REM	SQ FT	1,665.000				
78000100	THPL PVT MK LTR & SYM	SQ FT	47.000				
78000200	THPL PVT MK LINE 4	FOOT	5,480.000				
78000500	THPL PVT MK LINE 8	FOOT	949.000				
78000600	THPL PVT MK LINE 12	FOOT	549.000				

ILLINOIS DEPARTMENT OF TRANSPORTATION  
 SCHEDULE OF PRICES  
 CONTRACT  
 NUMBER - 64L37

State Job # - C-92-075-16

Project Number

Route

County Name - WINNEBAGO - -

FAS 55

Code - 201 - -

District - 2 - -

Section Number - 102RS-3

Item Number	Pay Item Description	Unit of Measure	Quantity	x	Unit Price	=	Total Price
78001110	PAINT PVT MK LINE 4	FOOT	221,107.000				
78100100	RAISED REFL PAVT MKR	EACH	538.000				
78300100	PAVT MARKING REMOVAL	SQ FT	37,689.000				
78300200	RAISED REF PVT MK REM	EACH	448.000				

**CONTRACT NUMBER**

**64L37**

**THIS IS THE TOTAL BID**

**\$ \_\_\_\_\_**

**NOTES:**

- 1. Each PAY ITEM should have a UNIT PRICE and a TOTAL PRICE.**
- 2. The UNIT PRICE shall govern if no TOTAL PRICE is shown or if there is a discrepancy between the product of the UNIT PRICE multiplied by the QUANTITY.**
- 3. If a UNIT PRICE is omitted, the TOTAL PRICE will be divided by the QUANTITY in order to establish a UNIT PRICE.**
- 4. A bid may be declared UNACCEPTABLE if neither a unit price nor a total price is shown.**

## RETURN WITH BID

### **STATE REQUIRED ETHICAL STANDARDS GOVERNING CONTRACT PROCUREMENT: ASSURANCES, CERTIFICATIONS AND DISCLOSURES**

#### I. GENERAL

A. Article 50 of the Code establishes the duty of all State CPOs, SPOs, and their designees to maximize the value of the expenditure of public moneys in procuring goods, services, and contracts for the State of Illinois and to act in a manner that maintains the integrity and public trust of State government. In discharging this duty, they are charged by law to use all available information, reasonable efforts, and reasonable actions to protect, safeguard, and maintain the procurement process of the State of Illinois.

B. In order to comply with the provisions of Article 50 and to carry out the duty established therein, all bidders are to adhere to ethical standards established for the procurement process, and to make such assurances, disclosures and certifications required by law. Except as otherwise required in subsection III, paragraphs J-M, by execution of the Proposal Signature Sheet, the bidder indicates that each of the mandated assurances have been read and understood, that each certification is made and understood, and that each disclosure requirement has been understood and completed.

C. In addition to all other remedies provided by law, failure to comply with any assurance, failure to make any disclosure or the making of a false certification shall be grounds for the CPO to void the contract, and may result in the suspension or debarment of the bidder or subcontractor. If a false certification is made by a subcontractor the contractor's submitted bid and the executed contract may not be declared void unless the contractor refuses to terminate the subcontract upon the State's request after a finding that the subcontractor's certification was false.

I acknowledge, understand and accept these terms and conditions.

#### II. ASSURANCES

The assurances hereinafter made by the bidder are each a material representation of fact upon which reliance is placed should the Department enter into the contract with the bidder.

##### A. Conflicts of Interest

Section 50-13. Conflicts of Interest.

(a) Prohibition. It is unlawful for any person holding an elective office in this State, holding a seat in the General Assembly, or appointed to or employed in any of the offices or agencies of state government and who receives compensation for such employment in excess of 60% of the salary of the Governor of the State of Illinois, or who is an officer or employee of the Capital Development Board or the Illinois State Toll Highway Authority, or who is the spouse or minor child of any such person to have or acquire any contract, or any direct pecuniary interest in any contract therein, whether for stationery, printing, paper, or any services, materials, or supplies, that will be wholly or partially satisfied by the payment of funds appropriated by the General Assembly of the State of Illinois or in any contract of the Capital Development Board or the Illinois State Toll Highway Authority.

(b) Interests. It is unlawful for any firm, partnership, association or corporation, in which any person listed in subsection (a) is entitled to receive (i) more than 7 1/2% of the total distributable income or (ii) an amount in excess of the salary of the Governor, to have or acquire any such contract or direct pecuniary interest therein.

(c) Combined interests. It is unlawful for any firm, partnership, association, or corporation, in which any person listed in subsection (a) together with his or her spouse or minor children is entitled to receive (i) more than 15%, in the aggregate, of the total distributable income or (ii) an amount in excess of 2 times the salary of the Governor, to have or acquire any such contract or direct pecuniary interest therein.

(d) Securities. Nothing in this Section invalidates the provisions of any bond or other security previously offered or to be offered for sale or sold by or for the State of Illinois.

(e) Prior interests. This Section does not affect the validity of any contract made between the State and an officer or employee of the State or member of the General Assembly, his or her spouse, minor child or any combination of those persons if that contract was in existence before his or her election or employment as an officer, member, or employee. The contract is voidable, however, if it cannot be completed within 365 calendar days after the officer, member, or employee takes office or is employed. The current salary of the Governor is \$177,412.00. Sixty percent of the salary is \$106,447.20.

## RETURN WITH BID

The bidder assures the Department that the award and execution of the contract would not cause a violation of Section 50-13, or that an effective exemption has been issued by the Board of Ethics to any individual subject to the Section 50-13 prohibitions pursuant to the provisions of Section 50-20 of the Code. Information concerning the exemption process is available from the Department upon request.

### **B. Negotiations**

Section 50-15. Negotiations.

It is unlawful for any person employed in or on a continual contractual relationship with any of the offices or agencies of State government to participate in contract negotiations on behalf of that office or agency with any firm, partnership, association, or corporation with whom that person has a contract for future employment or is negotiating concerning possible future employment.

The bidder assures the Department that the award and execution of the contract would not cause a violation of Section 50-15, and that the bidder has no knowledge of any facts relevant to the kinds of acts prohibited therein.

### **C. Inducements**

Section 50-25. Inducement.

Any person who offers or pays any money or other valuable thing to any person to induce him or her not to provide a submission to a vendor portal or to bid for a State contract or as recompense for not having bid on a State contract is guilty of a Class 4 felony. Any person who accepts any money or other valuable thing for not bidding for a State contract, not making a submission to a vendor portal, or who withholds a bid or submission to a vendor portal in consideration of the promise for the payment of money or other valuable thing is guilty of a Class 4 felony.

The bidder assures the Department that the award and execution of the contract would not cause a violation of Section 50-25, and that the bidder has no knowledge of any facts relevant to the kinds of acts prohibited therein.

### **D. Revolving Door Prohibition**

Section 50-30. Revolving door prohibition.

CPOs, SPOs, procurement compliance monitors, their designees whose principal duties are directly related to State procurement, and executive officers confirmed by the Senate are expressly prohibited for a period of 2 years after terminating an affected position from engaging in any procurement activity relating to the State agency most recently employing them in an affected position for a period of at least 6 months. The prohibition includes, but is not limited to: lobbying the procurement process; specifying; bidding; proposing bid, proposal, or contract documents; on their own behalf or on behalf of any firm, partnership, association, or corporation. This Section applies only to persons who terminate an affected position on or after January 15, 1999.

The bidder assures the Department that the award and execution of the contract would not cause a violation of Section 50-30, and that the bidder has no knowledge of any facts relevant to the kinds of acts prohibited therein.

### **E. Reporting Anticompetitive Practices**

Section 50-40. Reporting anticompetitive practices.

When, for any reason, any vendor, bidder, contractor, CPO, SPO, designee, elected official, or State employee suspects collusion or other anticompetitive practice among any bidders, offerors, contractors, proposers, or employees of the State, a notice of the relevant facts shall be transmitted to the Attorney General and the CPO.

The bidder assures the Department that it has not failed to report any relevant facts concerning the practices addressed in Section 50-40 which may involve the contract for which the bid or submission to a vendor portal is submitted.

### **F. Confidentiality**

Section 50-45. Confidentiality.

Any CPO, SPO, designee, or executive officer who willfully uses or allows the use of specifications, competitive bid documents, proprietary competitive information, proposals, contracts, or selection information to compromise the fairness or integrity of the procurement, bidding, or contract process shall be subject to immediate dismissal, regardless of the Personnel code, any contract, or any collective bargaining agreement, and may in addition be subject to criminal prosecution.

The bidder assures the Department that it has no knowledge of any fact relevant to the practices addressed in Section 50-45 which may involve the contract for which the bid is submitted.

## RETURN WITH BID

### G. Insider Information

Section 50-50. Insider information.

It is unlawful for any current or former elected or appointed State official or State employee to knowingly use confidential information available only by virtue of that office or employment for actual or anticipated gain for themselves or another person.

The bidder assures the Department that it has no knowledge of any facts relevant to the practices addressed in Section 50-50 which may involve the contract for which the bid is submitted.

I acknowledge, understand and accept these terms and conditions for the above assurances.

### III. CERTIFICATIONS

The certifications hereinafter made by the bidder are each a material representation of fact upon which reliance is placed should the Department enter into the contract with the bidder. Section 50-2 of the Code provides that every person that has entered into a multi-year contract and every subcontractor with a multi-year subcontract shall certify, by July 1 of each fiscal year covered by the contract after the initial fiscal year, to the responsible CPO whether it continues to satisfy the requirements of Article 50 pertaining to the eligibility for a contract award. If a contractor or subcontractor is not able to truthfully certify that it continues to meet all requirements, it shall provide with its certification a detailed explanation of the circumstances leading to the change in certification status. A contractor or subcontractor that makes a false statement material to any given certification required under Article 50 is, in addition to any other penalties or consequences prescribed by law, subject to liability under the Whistleblower Reward and Protection Act for submission of a false claim.

#### A. Bribery

Section 50-5. Bribery.

(a) Prohibition. No person or business shall be awarded a contract or subcontract under this Code who:

(1) has been convicted under the laws of Illinois or any other state of bribery or attempting to bribe an officer or employee of the State of Illinois or any other state in that officer's or employee's official capacity; or

(2) has made an admission of guilt of that conduct that is a matter of record but has not been prosecuted for that conduct.

(b) Businesses. No business shall be barred from contracting with any unit of State or local government, or subcontracting under such a contract, as a result of a conviction under this Section of any employee or agent of the business if the employee or agent is no longer employed by the business and:

(1) the business has been finally adjudicated not guilty; or

(2) the business demonstrates to the governmental entity with which it seeks to contract, or which is signatory to the contract which the subcontract relates, and that entity finds that the commission of the offense was not authorized, requested, commanded, or performed by a director, officer, or high managerial agent on behalf of the business as provided in paragraph (2) of subsection (a) of Section 5-4 of the Criminal Code of 2012.

(c) Conduct on behalf of business. For purposes of this Section, when an official, agent, or employee of a business committed the bribery or attempted bribery on behalf of the business and in accordance with the direction or authorization of a responsible official of the business, the business shall be chargeable with the conduct.

(d) Certification. Every bid submitted to and contract executed by the State, and every subcontract subject to Section 20-120 of the Code shall contain a certification by the contractor or the subcontractor, respectively, that the contractor or subcontractor is not barred from being awarded a contract or subcontract under this Section and acknowledges that the CPO may declare the related contract void if any certifications required by this Section are false. A contractor who makes a false statement, material to the certification, commits a Class 3 felony.

The contractor or subcontractor certifies that it is not barred from being awarded a contract under Section 50-5.

#### B. Felons

Section 50-10. Felons.

(a) Unless otherwise provided, no person or business convicted of a felony shall do business with the State of Illinois or any State agency, or enter into a subcontract, from the date of conviction until 5 years after the date of completion of the sentence for that felony, unless no person held responsible by a prosecutorial office for the facts upon which the conviction was based continues to have any involvement with the business.

(b) Certification. Every bid submitted to and contract executed by the State and every subcontract subject to Section 20-120 of the Code and every vendor's submission to a vendor portal shall contain a certification by the bidder or contractor or subcontractor, respectively, that the bidder, contractor, or subcontractor is not barred from being awarded a contract or subcontract under this Section and acknowledges that the CPO may declare the related contract void if any of the certifications required by this Section are false.

## RETURN WITH BID

### **C. Debt Delinquency**

Section 50-11 and 50-12. Debt Delinquency.

The contractor or bidder or subcontractor, respectively, certifies that it, or any affiliate, is not barred from being awarded a contract or subcontract under the Code. Section 50-11 prohibits a person from entering into a contract with a State agency, or entering into a subcontract, if it knows or should know that it, or any affiliate, is delinquent in the payment of any debt to the State as defined by the Debt Collection Board. Section 50-12 prohibits a person from entering into a contract with a State agency, or entering into a subcontract, if it, or any affiliate, has failed to collect and remit Illinois Use Tax on all sales of tangible personal property into the State of Illinois in accordance with the provisions of the Illinois Use Tax Act. The bidder or contractor or subcontractor, respectively, further acknowledges that the CPO may declare the related contract void if this certification is false or if the bidder, contractor, or subcontractor, or any affiliate, is determined to be delinquent in the payment of any debt to the State during the term of the contract.

### **D. Prohibited Bidders, Contractors and Subcontractors**

Section 50-10.5 and 50-60(c). Prohibited bidders, contractors and subcontractors.

The bidder or contractor or subcontractor, respectively, certifies in accordance with Section 50-10.5 that no officer, director, partner or other managerial agent of the contracting business has been convicted of a felony under the Sarbanes-Oxley Act of 2002 or a Class 3 or Class 2 felony under the Illinois Securities Law of 1953 or if in violation of Subsection (c) for a period of five years from the date of conviction. Every bid submitted to and contract executed by the State and every subcontract subject to Section 20-120 of the Code shall contain a certification by the bidder, contractor, or subcontractor, respectively, that the bidder, contractor, or subcontractor is not barred from being awarded a contract or subcontract under this Section and acknowledges that the CPO shall declare the related contract void if any of the certifications completed pursuant to this Section are false.

### **E. Section 42 of the Environmental Protection Act**

Section 50-14 Environmental Protection Act violations.

The bidder or contractor or subcontractor, respectively, certifies in accordance with Section 50-14 that the bidder, contractor, or subcontractor, is not barred from being awarded a contract or entering into a subcontract under this Section which prohibits the bidding on or entering into contracts with the State of Illinois or a State agency, or entering into any subcontract, that is subject to the Code by a person or business found by a court or the Pollution Control Board to have committed a willful or knowing violation of Section 42 of the Environmental Protection Act for a period of five years from the date of the order. The bidder or contractor or subcontractor, respectively, acknowledges that the CPO may declare the contract void if this certification is false.

### **F. Educational Loan**

Section 3 of the Educational Loan Default Act, 5 ILCS 385/3.

Pursuant to the Educational Loan Default Act no State agency shall contract with an individual for goods or services if that individual is in default on an educational loan.

The bidder, if an individual as opposed to a corporation, partnership or other form of business organization, certifies that the bidder is not in default on an educational loan as provided in Section 3 of the Act.

### **G. Bid-Rigging/Bid Rotating**

Section 33E-11 of the Criminal Code of 2012, 720 ILCS 5/33E-11.:

(a) Every bid submitted to and public contract executed pursuant to such bid by the State or a unit of local government shall contain a certification by the prime contractor that the prime contractor is not barred from contracting with any unit of State or local government as a result of a violation of either Section 33E-3 or 33E-4 of this Article

(b) A contractor who makes a false statement, material to the certification, commits a Class 3 felony.

A violation of Section 33E-3 would be represented by a conviction of the crime of bid-rigging which, in addition to Class 3 felony sentencing, provides that any person convicted of this offense or any similar offense of any state or the United States which contains the same elements as this offense shall be barred for 5 years from the date of conviction from contracting with any unit of State or local government. No corporation shall be barred from contracting with any unit of State or local government as a result of a conviction under this Section of any employee or agent of such corporation if the employee so convicted is no longer employed by the corporation and: (1) it has been finally adjudicated not guilty or (2) if it demonstrates to the governmental entity with which it seeks to contract and that entity finds that the commission of the offense was neither authorized, requested, commanded, nor performed by a director, officer or a high managerial agent in behalf of the corporation.

The bidder certifies that it is not barred from contracting with the Department by reason of a violation of either Section 33E-3 or Section 33E-4.

## RETURN WITH BID

### **H. International Anti-Boycott**

Section 5 of the International Anti-Boycott Certification Act provides every contract entered into by the State of Illinois for the manufacture, furnishing, or purchasing of supplies, material, or equipment or for the furnishing of work, labor, or services, in an amount exceeding the threshold for small purchases according to the purchasing laws of this State or \$10,000.00, whichever is less, shall contain certification, as a material condition of the contract, by which the contractor agrees that neither the contractor nor any substantially-owned affiliated company is participating or shall participate in an international boycott in violation of the provisions of the U.S. Export Administration Act of 1979 or the regulations of the U.S. Department of Commerce promulgated under that Act.

The bidder makes the certification set forth in Section 5 of the Act.

### **I. Drug Free Workplace**

The Illinois "Drug Free Workplace Act" applies to this contract and it is necessary to comply with the provisions of the "Act" if the contractor is a corporation, partnership, or other entity (including a sole proprietorship) which has 25 or more employees.

The bidder certifies that if awarded a contract in excess of \$5,000 it will provide a drug free workplace in compliance with the provisions of the Act.

### **J. Disclosure of Business Operations in Iran**

Section 50-36 of the Code provides that each bid, offer, or proposal submitted for a State contract shall include a disclosure of whether or not the Company acting as the bidder, offeror, or proposing entity, or any of its corporate parents or subsidiaries, within the 24 months before submission of the bid, offer, or proposal had business operations that involved contracts with or provision of supplies or services to the Government of Iran, companies in which the Government of Iran has any direct or indirect equity share, consortiums or projects commissioned by the Government of Iran, or companies involved in consortiums or projects commissioned by the Government of Iran and either of the following conditions apply:

- (1) More than 10% of the Company's revenues produced in or assets located in Iran involve oil-related activities or mineral-extraction activities; less than 75% of the Company's revenues produced in or assets located in Iran involve contracts with or provision of oil-related or mineral-extraction products or services to the Government of Iran or a project or consortium created exclusively by that government; and the Company has failed to take substantial action.
- (2) The Company has, on or after August 5, 1996, made an investment of \$20 million or more, or any combination of investments of at least \$10 million each that in the aggregate equals or exceeds \$20 million in any 12-month period, which directly or significantly contributes to the enhancement of Iran's ability to develop petroleum resources of Iran.

The terms "Business operations", "Company", "Mineral-extraction activities", "Oil-related activities", "Petroleum resources", and "Substantial action" are all defined in the Code.

Failure to make the disclosure required by the Code may cause the bid, offer or proposal to be considered not responsive. The disclosure will be considered when evaluating the bid or awarding the contract. The name of each Company disclosed as doing business or having done business in Iran will be provided to the State Comptroller.

Check the appropriate statement:

Company has no business operations in Iran to disclose.

Company has business operations in Iran as disclosed on the attached document.



## RETURN WITH BID

### **K. Apprenticeship and Training Certification (Does not apply to federal aid projects)**

In accordance with the provisions of Section 30-22 (6) of the Code, the bidder certifies that it is a participant, either as an individual or as part of a group program, in the approved apprenticeship and training programs applicable to each type of work or craft that the bidder will perform with its own forces. The bidder further certifies for work that will be performed by subcontract that each of its subcontractors submitted for approval either (a) is, at the time of such bid, participating in an approved, applicable apprenticeship and training program; or (b) will, prior to commencement of performance of work pursuant to this contract, begin participation in an approved apprenticeship and training program applicable to the work of the subcontract. The Department, at any time before or after award, may require the production of a copy of each applicable Certificate of Registration issued by the United States Department of Labor evidencing such participation by the contractor and any or all of its subcontractors. Applicable apprenticeship and training programs are those that have been approved and registered with the United States Department of Labor. The bidder shall list in the space below, the official name of the program sponsor holding the Certificate of Registration for all of the types of work or crafts in which the bidder is a participant and that will be performed with the bidder's forces. Types of work or craft work that will be subcontracted shall be included and listed as subcontract work. The list shall also indicate any type of work or craft job category that does not have an applicable apprenticeship or training program. **The bidder is responsible for making a complete report and shall make certain that each type of work or craft job category that will be utilized on the project as reported on the Construction Employee Workforce Projection (Form BC-1256) and returned with the bid is accounted for and listed.**

Additionally, Section 30-22 of the Code requires that the bidder certify that an Illinois office be maintained as the primary place of employment for persons employed for this contract.

---

---

---

The requirements of these certifications and disclosures are a material part of the contract, and the contractor shall require these certification provisions to be included in all approved subcontracts. In order to fulfill this requirement, it shall not be necessary that an applicable program sponsor be currently taking, or that it will take applications for apprenticeship, training or employment during the performance of the work of this contract.

**TO BE RETURNED WITH BID**

**L. Political Contributions and Registration with the State Board of Elections**

Sections 20-160 and 50-37 of the Code regulate political contributions from business entities and any affiliated entities or affiliated persons bidding on or contracting with the state. Generally under Section 50-37, any business entity, and any affiliated entity or affiliated person of the business entity, whose current year contracts with all state agencies exceed an awarded value of \$50,000, are prohibited from making any contributions to any political committees established to promote the candidacy of the officeholder responsible for the awarding of the contracts or any other declared candidate for that office for the duration of the term of office of the incumbent officeholder or a period 2 years after the termination of the contract, whichever is longer. Any business entity and affiliated entities or affiliated persons whose state contracts in the current year do not exceed an awarded value of \$50,000, but whose aggregate pending bids and proposals on state contracts exceed \$50,000, either alone or in combination with contracts not exceeding \$50,000, are prohibited from making any political contributions to any political committee established to promote the candidacy of the officeholder responsible for awarding the pending contract during the period beginning on the date the invitation for bids or request for proposals or any other procurement opportunity is issued and ending on the day after the date of award or selection if the entity was not awarded or selected. Section 20-160 requires certification of registration of affected business entities in accordance with procedures found in Section 9-35 of The Election Code.

By submission of a bid, the contractor business entity acknowledges and agrees that it has read and understands Sections 20-160 and 50-37 of the Code, and that it makes the following certification:

**The undersigned bidder certifies that it has registered as a business with the State Board of Elections and acknowledges a continuing duty to update the registration in accordance with the above referenced statutes. If the business entity is required to register, the CPO shall verify that it is in compliance on the date the bid or proposal is due. The CPO shall not accept a bid or proposal if the business entity is not in compliance with the registration requirements.**

These requirements and compliance with the above referenced statutory sections are a material part of the contract, and any breach thereof shall be cause to void the contract under Section 50-60 of the Code. This provision does not apply to Federal-aid contracts.

**M. Lobbyist Disclosure**

Section 50-38 of the Code requires that any bidder or offeror on a State contract that hires a person required to register under the Lobbyist Registration Act to assist in obtaining a contract shall:

- (i) Disclose all costs, fees, compensation, reimbursements, and other remunerations paid or to be paid to the lobbyist related to the contract,
- (ii) Not bill or otherwise cause the State of Illinois to pay for any of the lobbyist's costs, fees, compensation, reimbursements, or other remuneration, and
- (iii) Sign a verification certifying that none of the lobbyist's costs, fees, compensation, reimbursements, or other remuneration were billed to the State.

This information, along with all supporting documents, shall be filed with the agency awarding the contract and with the Secretary of State. The CPO shall post this information, together with the contract award notice, in the online Procurement Bulletin.

Pursuant to Subsection (c) of this Section, no person or entity shall retain a person or entity to attempt to influence the outcome of a procurement decision made under the Code for compensation contingent in whole or in part upon the decision or procurement. Any person who violates this subsection is guilty of a business offense and shall be fined not more than \$10,000.

Bidder acknowledges that it is required to disclose the hiring of any person required to register pursuant to the Illinois Lobbyist Registration Act (25 ILCS 170) in connection with this contract.

Bidder has not hired any person required to register pursuant to the Illinois Lobbyist Registration Act in connection with this contract.

Or

Bidder has hired the following persons required to register pursuant to the Illinois Lobbyist Registration Act in connection with the contract:

Name and address of person: \_\_\_\_\_  
All costs, fees, compensation, reimbursements and other remuneration paid to said person: \_\_\_\_\_

\_\_\_\_\_

I acknowledge, understand and accept these terms and conditions for the above certifications.

## RETURN WITH BID

### IV. DISCLOSURES

- A. The disclosures hereinafter made by the bidder are each a material representation of fact upon which reliance is placed should the Department enter into the contract with the bidder. The bidder further certifies that the Department has received the disclosure forms for each bid.

The CPO may void the bid, or contract, respectively, if it is later determined that the bidder or subcontractor rendered a false or erroneous disclosure. A contractor or subcontractor may be suspended or debarred for violations of the Code. Furthermore, the CPO may void the contract and the surety providing the performance bond shall be responsible for completion of the contract.

### B. Financial Interests and Conflicts of Interest

1. Section 50-35 of the Code provides that all bids of more than \$50,000 and all submissions to a vendor portal shall be accompanied by disclosure of the financial interests of the bidder. This disclosed information for the successful bidder, will be maintained as public information subject to release by request pursuant to the Freedom of Information Act, filed with the Procurement Policy Board, and shall be incorporated as a material term of the contract. Furthermore, pursuant to Section 5-5, the Procurement Policy Board may review a proposal, bid, or contract and issue a recommendation to void a contract or reject a proposal or bid based on any violation of the Code or the existence of a conflict of interest as provided in subsections (b) and (d) of Section 50-35.

The financial interests to be disclosed shall include ownership or distributive income share that is in excess of 5%, or an amount greater than 60% of the annual salary of the Governor, of the bidding entity or its parent entity, whichever is less, unless the contractor or bidder is a publicly traded entity subject to Federal 10K reporting, in which case it may submit its 10K disclosure in place of the prescribed disclosure. If a bidder is a privately held entity that is exempt from Federal 10K reporting, but has more than 100 shareholders, it may submit the information that Federal 10K companies are required to report, and list the names of any person or entity holding any ownership share that is in excess of 5%. The disclosure shall include the names, addresses, and dollar or proportionate share of ownership of each individual making the disclosure, their instrument of ownership or beneficial relationship, and notice of any potential conflict of interest resulting from the current ownership or beneficial interest of each individual making the disclosure having any of the relationships identified in Section 50-35 and on the disclosure form.

**The current annual salary of the Governor is \$177,412.00**

In addition, all disclosures shall indicate any other current or pending contracts, proposals, leases, or other ongoing procurement relationships the bidding entity has with any other unit of state government and shall clearly identify the unit and the contract, proposal, lease, or other relationship.

2. Disclosure Forms. Disclosure Form A is attached for use concerning the individuals meeting the above ownership or distributive share requirements. A separate Disclosure Form A must be submitted with the bid for each individual meeting the above requirements. In addition, a second form (Disclosure Form B) provides for the disclosure of current or pending procurement relationships with other (non-IDOT) state agencies and a total ownership certification. **The forms must be included with each bid.**

### C. Disclosure Form Instructions

#### Form A Instructions for Financial Information & Potential Conflicts of Interest

If the bidder is a publicly traded entity subject to Federal 10K reporting, the 10K Report may be submitted to meet the requirements of Form A. If a bidder is a privately held entity that is exempt from Federal 10K reporting, but has more than 100 shareholders, it may submit the information that Federal 10K companies are required to report, and list the names of any person or entity holding any ownership share that is in excess of 5%. If a bidder is not subject to Federal 10K reporting, the bidder must determine if any individuals are required by law to complete a financial disclosure form. To do this, the bidder should answer each of the following questions. A "YES" answer indicates Form A must be completed. If the answer to each of the following questions is "NO", then the NOT APPLICABLE STATEMENT on Form A must be signed and dated by an individual that is authorized to execute contracts for the bidding company. Note: These questions are for assistance only and are not required to be completed.

1. Does anyone in your organization have a direct or beneficial ownership share of greater than 5% of the bidding entity or parent entity? YES \_\_\_ NO \_\_\_
2. Does anyone in your organization have a direct or beneficial ownership share of less than 5%, but which has a value greater than 60% of the annual salary of the Governor? YES \_\_\_ NO \_\_\_
3. Does anyone in your organization receive more than 60% of the annual salary of the Governor of the bidding entity's or parent entity's distributive income? YES \_\_\_ NO \_\_\_

(Note: Distributive income is, for these purposes, any type of distribution of profits. An annual salary is not distributive income.)

4. Does anyone in your organization receive greater than 5% of the bidding entity's or parent entity's total distributive income, but which is less than 60% of the annual salary of the Governor? YES \_\_\_ NO \_\_\_

(Note: Only one set of forms needs to be completed per individual per bid even if a specific individual would require a yes answer to more than one question.)

A "YES" answer to any of these questions requires the completion of Form A. The bidder must determine each individual in the bidding entity or the bidding entity's parent company that would cause the questions to be answered "Yes". Each form must be signed and dated by an individual that is authorized to execute contracts for your organization. The individual signing can be, but does not have to be, the individual for which the form is being completed. The bidder is responsible for the accuracy of any information provided.

If the answer to each of the above questions is "NO", then the NOT APPLICABLE STATEMENT of Form A must be signed and dated by an individual that is authorized to execute contracts for your company.

## RETURN WITH BID

### **Form B: Instructions for Identifying Other Contracts & Procurement Related Information**

Disclosure Form B must be completed for each bid submitted by the bidding entity. *Note: Checking the NOT APPLICABLE STATEMENT on Form A does not allow the bidder to ignore Form B. Form B must be completed, checked, and dated or the bidder may be considered nonresponsive and the bid will not be accepted.*

The Bidder shall identify, by checking Yes or No on Form B, whether it has any pending contracts (including leases), bids, proposals, or other ongoing procurement relationship with any other (non-IDOT) State of Illinois agency. If "No" is checked, the bidder only needs to complete the check box on the bottom of Form B. If "Yes" is checked, the bidder must do one of the following:

Option I: If the bidder did not submit an Affidavit of Availability to obtain authorization to bid, the bidder must list all non-IDOT State of Illinois agency pending contracts, leases, bids, proposals, and other ongoing procurement relationships. These items may be listed on Form B or on an attached sheet(s). Do not include IDOT contracts. Contracts with cities, counties, villages, etc. are not considered State of Illinois agency contracts and are not to be included. Contracts with other State of Illinois agencies such as the Department of Natural Resources or the Capital Development Board must be included. Bidders who submit Affidavits of Availability are suggested to use Option II.

Option II: If the bidder is required and has submitted an Affidavit of Availability in order to obtain authorization to bid, the bidder may write or type "See Affidavit of Availability" which indicates that the Affidavit of Availability is incorporated by reference and includes all non-IDOT State of Illinois agency pending contracts, leases, bids, proposals, and other ongoing procurement relationships. For any contracts that are not covered by the Affidavit of Availability, the bidder must identify them on Form B or on an attached sheet(s). These might be such things as leases.

ILLINOIS DEPARTMENT OF TRANSPORTATION

Form A Financial Information & Potential Conflicts of Interest Disclosure

Contractor Name, Legal Address, City, State, Zip, Telephone Number, Email Address, Fax Number (if available)

Disclosure of the information contained in this Form is required by Section 50-35 of the Code (30 ILCS 500). Vendors desiring to enter into a contract with the State of Illinois must disclose the financial information and potential conflict of interest information as specified in this Disclosure Form. This information shall become part of the publicly available contract file. This Form A must be completed for bids in excess of \$50,000, and for all open-ended contracts. A publicly traded company may submit a 10K disclosure (or equivalent if applicable) in satisfaction of the requirements set forth in Form A. See Disclosure Form Instructions.

The current annual salary of the Governor is \$177,412.00.

DISCLOSURE OF FINANCIAL INFORMATION

1. Disclosure of Financial Information. The individual named below has an interest in the BIDDER (or its parent) in terms of ownership or distributive income share in excess of 5%, or an interest which has a value of more than 60% of the annual salary of the Governor. (Make copies of this form as necessary and attach a separate Disclosure Form A for each individual meeting these requirements)

FOR INDIVIDUAL (type or print information) NAME: ADDRESS Type of ownership/distributable income share: stock sole proprietorship Partnership other: (explain on separate sheet): % or \$ value of ownership/distributable income share:

2. Disclosure of Potential Conflicts of Interest. Check "Yes" or "No" to indicate which, if any, of the following potential conflict of interest relationships apply. If the answer to any question is "Yes", please attach additional pages and describe.

(a) State employment, currently or in the previous 3 years, including contractual employment of services. Yes \_\_\_ No \_\_\_

If your answer is yes, please answer each of the following questions.

1. Are you currently an officer or employee of either the Capitol Development Board or the Illinois State Toll Highway Authority? Yes \_\_\_ No \_\_\_

2. Are you currently appointed to or employed by any agency of the State of Illinois? If you are currently appointed to or employed by any agency of the State of Illinois, and your annual salary exceeds 60% of the annual salary of the Governor, provide the name the State agency for which you are employed and your annual salary.

## RETURN WITH BID

3. If you are currently appointed to or employed by any agency of the State of Illinois, and your annual salary exceeds 60% of the annual salary of the Governor, are you entitled to receive (i) more than 7 1/2% of the total distributable income of your firm, partnership, association or corporation, or (ii) an amount in excess of 100% of the annual salary of the Governor?  
Yes \_\_\_ No \_\_\_

4. If you are currently appointed to or employed by any agency of the State of Illinois, and your annual salary exceeds 60% of the annual salary of the Governor, are you and your spouse or minor children entitled to receive (i) more than 15 % in the aggregate of the total distributable income of your firm, partnership, association or corporation, or (ii) an amount in excess of two times the salary of the Governor?  
Yes \_\_\_ No \_\_\_

---

(b) State employment of spouse, father, mother, son, or daughter, including contractual employment for services in the previous 2 years.

Yes \_\_\_ No \_\_\_

If your answer is yes, please answer each of the following questions.

1. Is your spouse or any minor children currently an officer or employee of the Capitol Development Board or the Illinois State Toll Highway Authority?  
Yes \_\_\_ No \_\_\_

2. Is your spouse or any minor children currently appointed to or employed by any agency of the State of Illinois? If your spouse or minor children is/are currently appointed to or employed by any agency of the State of Illinois, and his/her annual salary exceeds 60% of the annual salary of the Governor, provide the name of your spouse and/or minor children, the name of the State agency for which he/she is employed and his/her annual salary. \_\_\_\_\_  
\_\_\_\_\_

3. If your spouse or any minor children is/are currently appointed to or employed by any agency of the State of Illinois, and his/her annual salary exceeds 60% of the annual salary of the Governor, are you entitled to receive (i) more than 7 1/2% of the total distributable income of your firm, partnership, association or corporation, or (ii) an amount in excess of 100% of the annual salary of the Governor?  
Yes \_\_\_ No \_\_\_

4. If your spouse or any minor children are currently appointed to or employed by any agency of the State of Illinois, and his/her annual salary exceeds 60% of the annual salary of the Governor, are you and your spouse or minor children entitled to receive (i) more than 15 % in the aggregate of the total distributable income of your firm, partnership, association or corporation, or (ii) an amount in excess of two times the salary of the Governor?  
Yes \_\_\_ No \_\_\_

---

(c) Elective status; the holding of elective office of the State of Illinois, the government of the United States, any unit of local government authorized by the Constitution of the State of Illinois or the statutes of the State of Illinois currently or in the previous 3 years.  
Yes \_\_\_ No \_\_\_

---

(d) Relationship to anyone holding elective office currently or in the previous 2 years; spouse, father, mother, son, or daughter.  
Yes \_\_\_ No \_\_\_

---

(e) Appointive office; the holding of any appointive government office of the State of Illinois, the United States of America, or any unit of local government authorized by the Constitution of the State of Illinois or the statutes of the State of Illinois, which office entitles the holder to compensation in excess of the expenses incurred in the discharge of that office currently or in the previous 3 years.  
Yes \_\_\_ No \_\_\_

---

(f) Relationship to anyone holding appointive office currently or in the previous 2 years; spouse, father, mother, son, or daughter.  
Yes \_\_\_ No \_\_\_

---

(g) Employment, currently or in the previous 3 years, as or by any registered lobbyist of the State government.  
Yes \_\_\_ No \_\_\_

---

**RETURN WITH BID**

(h) Relationship to anyone who is or was a registered lobbyist in the previous 2 years; spouse, father, mother, son, or daughter. Yes \_\_\_ No \_\_\_

---

(i) Compensated employment, currently or in the previous 3 years, by any registered election or reelection committee registered with the Secretary of State or any county clerk of the State of Illinois, or any political action committee registered with either the Secretary of State or the Federal Board of Elections. Yes \_\_\_ No \_\_\_

---

(j) Relationship to anyone; spouse, father, mother, son, or daughter; who was a compensated employee in the last 2 years by any registered election or re-election committee registered with the Secretary of State or any county clerk of the State of Illinois, or any political action committee registered with either the Secretary of State or the Federal Board of Elections. Yes \_\_\_ No \_\_\_

---

**3. Communication Disclosure.**

Disclose the name and address of each lobbyist and other agent of the bidder or offeror who is not identified in Section 2 of this form, who is has communicated, is communicating, or may communicate with any State officer or employee concerning the bid or offer. This disclosure is a continuing obligation and must be promptly supplemented for accuracy throughout the process and throughout the term of the contract. If no person is identified, enter "None" on the line below:

Name and address of person(s): \_\_\_\_\_  
\_\_\_\_\_  
\_\_\_\_\_  
\_\_\_\_\_

**RETURN WITH BID**

**4. Suspension or Debarment Disclosure.** For each of the persons identified under Sections 2 and 3 of this form, disclose whether any of the following has occurred within the previous 10 years: suspension or debarment from contracting with any governmental entity; professional licensure discipline; bankruptcies; adverse civil judgments and administrative findings; and criminal felony convictions. This disclosure is a continuing obligation and must be promptly supplemented for accuracy throughout the procurement process and term of the contract. If no person is identified, enter "None" on the line below:

Name of person(s): \_\_\_\_\_

Nature of disclosure: \_\_\_\_\_

\_\_\_\_\_  
\_\_\_\_\_

**APPLICABLE STATEMENT**

**This Disclosure Form A is submitted on behalf of the INDIVIDUAL named on previous page. Under penalty of perjury, I certify the contents of this disclosure to be true and accurate to the best of my knowledge.**

Completed by:  \_\_\_\_\_ Date \_\_\_\_\_  
Signature of Individual or Authorized Representative

**NOT APPLICABLE STATEMENT**

**Under penalty of perjury, I have determined that no individuals associated with this organization meet the criteria that would require the completion of this Form A.**

**This Disclosure Form A is submitted on behalf of the CONTRACTOR listed on the previous page.**

\_\_\_\_\_ Date \_\_\_\_\_  
Signature of Authorized Representative

**The bidder has a continuing obligation to supplement these disclosures under Sec. 50-35 of the Code.**



RETURN WITH BID

ILLINOIS DEPARTMENT OF TRANSPORTATION

Form B Other Contracts & Financial Related Information Disclosure

Contractor Name, Legal Address, City, State, Zip, Telephone Number, Email Address, Fax Number (if available)

Disclosure of the information contained in this Form is required by Section 50-35 of the Code (30 ILCS 500). This information shall become part of the publicly available contract file. This Form B must be completed for all bids.

DISCLOSURE OF OTHER CONTRACTS AND PROCUREMENT RELATED INFORMATION

1. Identifying Other Contracts & Procurement Related Information. The BIDDER shall identify whether it has any pending contracts (including leases), bids, proposals, or other ongoing procurement relationship with any other State of Illinois agency: Yes \_\_\_ No \_\_\_

If "No" is checked, the bidder only needs to complete the signature box on this page.

2. If "Yes" is checked. Identify each such relationship by showing State of Illinois agency name and other descriptive information such as bid or project number (attach additional pages as necessary). SEE DISCLOSURE FORM INSTRUCTIONS:

THE FOLLOWING STATEMENT MUST BE CHECKED

Signature of Authorized Representative, Date

OWNERSHIP CERTIFICATION

Please certify that the following statement is true if the individuals for all submitted Form A disclosures do not total 100% of ownership.

Any remaining ownership interest is held by individuals receiving less than \$106,447.20 of the bidding entity's or parent entity's distributive income or holding less than a 5% ownership interest.

Yes No N/A (Form A disclosure(s) established 100% ownership)

## **RETURN WITH BID**

### **SPECIAL NOTICE TO CONTRACTORS**

The following requirements of the Illinois Department of Human Rights Act are applicable to bidders on all construction contracts advertised by the Illinois Department of Transportation:

#### **CONSTRUCTION EMPLOYEE UTILIZATION PROJECTION**

- (a) All bidders on construction contracts shall complete and submit, along with and as part of their bids, a Bidder's Employee Utilization Form (Form BC-1256) setting forth a projection and breakdown of the total workforce intended to be hired and/or allocated to such contract work by the bidder including a projection of minority and female employee utilization in all job classifications on the contract project.
- (b) The Department of Transportation shall review the Employee Utilization Form, and workforce projections contained therein, of the contract awardee to determine if such projections reflect an underutilization of minority persons and/or women in any job classification in accordance with the Equal Employment Opportunity Clause and Title 44, Illinois Administrative Code, Section 750.120. If it is determined that the contract awardee's projections reflect an underutilization of minority persons and/or women in any job classification, it shall be advised in writing of the manner in which it is underutilizing and such awardee shall be considered to be in breach of the contract unless, prior to commencement of work on the contract project, it submits revised satisfactory projections or an acceptable written affirmative action plan to correct such underutilization including a specific timetable geared to the completion stages of the contract.
- (c) The Department of Transportation shall provide to the Department of Human Rights a copy of the contract awardee's Employee Utilization Form, a copy of any required written affirmative action plan, and any written correspondence related thereto. The Department of Human Rights may review and revise any action taken by the Department of Transportation with respect to these requirements.



**RETURN WITH BID**

**Contract No. 64L37  
WINNEBAGO County  
Section 102RS-3  
Route FAS 55  
District 2 Construction Funds**

**PART II. WORKFORCE PROJECTION - continued**

- B. Included in "Total Employees" under Table A is the total number of **new hires** that would be employed in the event the undersigned bidder is awarded this contract.

The undersigned bidder projects that: (number) \_\_\_\_\_ new hires would be recruited from the area in which the contract project is located; and/or (number) \_\_\_\_\_ new hires would be recruited from the area in which the bidder's principal office or base of operation is located.

- C. Included in "Total Employees" under Table A is a projection of numbers of persons to be employed directly by the undersigned bidder as well as a projection of numbers of persons to be employed by subcontractors.

The undersigned bidder estimates that (number) \_\_\_\_\_ persons will be directly employed by the prime contractor and that (number) \_\_\_\_\_ persons will be employed by subcontractors.

**PART III. AFFIRMATIVE ACTION PLAN**

- A. The undersigned bidder understands and agrees that in the event the foregoing minority and female employee utilization projection included under **PART II** is determined to be an underutilization of minority persons or women in any job category, and in the event that the undersigned bidder is awarded this contract, he/she will, prior to commencement of work, develop and submit a written Affirmative Action Plan including a specific timetable (geared to the completion stages of the contract) whereby deficiencies in minority and/or female employee utilization are corrected. Such Affirmative Action Plan will be subject to approval by the contracting agency and the **Illinois Department of Human Rights**.
- B. The undersigned bidder understands and agrees that the minority and female employee utilization projection submitted herein, and the goals and timetable included under an Affirmative Action Plan if required, are deemed to be part of the contract specifications.

Company \_\_\_\_\_ Telephone Number \_\_\_\_\_

Address \_\_\_\_\_

**NOTICE REGARDING SIGNATURE**

The Bidder's signature on the Proposal Signature Sheet will constitute the signing of this form. The following signature block needs to be completed if revisions are required.

Signature:  \_\_\_\_\_ Title: \_\_\_\_\_ Date: \_\_\_\_\_

- Instructions: All tables must include subcontractor personnel in addition to prime contractor personnel.
- Table A - Include both the number of employees that would be hired to perform the contract work and the total number currently employed (Table B) that will be allocated to contract work, and include all apprentices and on-the-job trainees. The "Total Employees" column should include all employees including all minorities, apprentices and on-the-job trainees to be employed on the contract work.
- Table B - Include all employees currently employed that will be allocated to the contract work including any apprentices and on-the-job trainees currently employed.
- Table C - Indicate the racial breakdown of the total apprentices and on-the-job trainees shown in Table A.

**RETURN WITH BID**

**Contract No. 64L37  
WINNEBAGO County  
Section 102RS-3  
Route FAS 55  
District 2 Construction Funds**

PROPOSAL SIGNATURE SHEET

The undersigned bidder hereby makes and submits this bid on the subject Proposal, thereby assuring the Department that all requirements of the Invitation for Bids and rules of the Department have been met, that there is no misunderstanding of the requirements of paragraph 3 of this Proposal, and that the contract will be executed in accordance with the rules of the Department if an award is made on this bid.

(IF AN INDIVIDUAL)

Firm Name \_\_\_\_\_

Signature of Owner \_\_\_\_\_

Business Address \_\_\_\_\_

\_\_\_\_\_

(IF A CO-PARTNERSHIP)

Firm Name \_\_\_\_\_

By \_\_\_\_\_

Business Address \_\_\_\_\_

\_\_\_\_\_

Name and Address of All Members of the Firm:

\_\_\_\_\_

\_\_\_\_\_

(IF A CORPORATION)

Corporate Name \_\_\_\_\_

By \_\_\_\_\_

Signature of Authorized Representative

\_\_\_\_\_

Typed or printed name and title of Authorized Representative

Attest \_\_\_\_\_

Signature

(IF A JOINT VENTURE, USE THIS SECTION FOR THE MANAGING PARTY AND THE SECOND PARTY SHOULD SIGN BELOW)

Business Address \_\_\_\_\_

\_\_\_\_\_

(IF A JOINT VENTURE)

Corporate Name \_\_\_\_\_

By \_\_\_\_\_

Signature of Authorized Representative

\_\_\_\_\_

Typed or printed name and title of Authorized Representative

Attest \_\_\_\_\_

Signature

Business Address \_\_\_\_\_

\_\_\_\_\_

If more than two parties are in the joint venture, please attach an additional signature sheet.



This Annual Proposal Bid Bond shall become effective at 12:01 AM (CDST) on \_\_\_\_\_ and shall be valid until \_\_\_\_\_ 11:59 PM (CDST).

KNOW ALL PERSONS BY THESE PRESENTS, That We \_\_\_\_\_

as PRINCIPAL, and \_\_\_\_\_

as SURETY, and held jointly, severally and firmly bound unto the STATE OF ILLINOIS in the penal sum of 5 percent of the total bid price, or for the amount specified in the bid proposal under "Proposal Guaranty" in effect on the date of the Invitation for Bids, whichever is the lesser sum, well and truly to be paid unto said STATE OF ILLINOIS, for the payment of which we bind ourselves, our heirs, executors, administrators, successors and assigns.

THE CONDITION OF THE FOREGOING OBLIGATION IS SUCH that whereas, the PRINCIPAL may submit bid proposal(s) to the STATE OF ILLINOIS, acting through the Department of Transportation, for various improvements published in the Transportation Bulletin during the effective term indicated above.

NOW, THEREFORE, if the Department shall accept the bid proposal(s) of the PRINCIPAL; and if the PRINCIPAL shall, within the time and as specified in the bidding and contract documents; and if, after award by the Department, the PRINCIPAL shall enter into a contract in accordance with the terms of the bidding and contract documents including evidence of the required insurance coverages and providing such bond as specified with good and sufficient surety for the faithful performance of such contract and for the prompt payment of labor and material furnished in the prosecution thereof; or if, in the event of the failure of the PRINCIPAL to enter into such contract and to give the specified bond, the PRINCIPAL pays to the Department the difference not to exceed the penalty hereof between the amount specified in the bid proposal and such larger amount for which the Department may contract with another party to perform the work covered by said bid proposal, then this obligation shall be null and void, otherwise, it shall remain in full force and effect.

IN THE EVENT the Department determines the PRINCIPAL has failed to comply with any requirement as set forth in the preceding paragraph, then Surety shall pay the penal sum to the Department within fifteen (15) days of written demand therefor. If Surety does not make full payment within such period of time, the Department may bring an action to collect the amount owed. Surety is liable to the Department for all its expenses, including attorney's fees, incurred in any litigation in which it prevails either in whole or in part.

In TESTIMONY WHEREOF, the said PRINCIPAL has caused this instrument to be signed by its officer \_\_\_\_\_ day of \_\_\_\_\_ A.D., \_\_\_\_\_

In TESTIMONY WHEREOF, the said SURETY has caused this instrument to be signed by its officer \_\_\_\_\_ day of \_\_\_\_\_ A.D., \_\_\_\_\_

\_\_\_\_\_  
(Company Name)

\_\_\_\_\_  
(Company Name)

By \_\_\_\_\_  
(Signature and Title)

By \_\_\_\_\_  
(Signature of Attorney-in-Fact)

**Notary for PRINCIPAL**

**Notary for SURETY**

STATE OF \_\_\_\_\_  
COUNTY OF \_\_\_\_\_

STATE OF \_\_\_\_\_  
COUNTY OF \_\_\_\_\_

Signed and attested before me on \_\_\_\_\_ (date)

Signed and attested before me on \_\_\_\_\_ (date)

by \_\_\_\_\_  
(Name of Notary Public)

by \_\_\_\_\_  
(Name of Notary Public)

(Seal) \_\_\_\_\_  
(Signature of Notary Public)

(Seal) \_\_\_\_\_  
(Signature of Notary Public)

\_\_\_\_\_  
(Date Commission Expires)

\_\_\_\_\_  
(Date Commission Expires)

In lieu of completing the above section of the Annual Proposal Bid Bond form, the Principal may file an Electronic Bid Bond. By signing the proposal(s) the Principal is ensuring the identified electronic bid bond has been executed and the Principal and Surety are firmly bound unto the State of Illinois under the conditions of the bid bond as shown above.

---

Electronic Bid Bond ID #	Company/Bidder Name	Signature and Title
--------------------------	---------------------	---------------------

This bond may be terminated, at Surety's request, upon giving not less than thirty (30) days prior written notice of the cancellation/termination of the bond. Said written notice shall be issued to the Illinois Department of Transportation, Chief Contracts Official, 2300 South Dirksen Parkway, Springfield, Illinois, 62764, and shall be served in person, by receipted courier delivery or certified or registered mail, return receipt requested. Said notice period shall commence on the first calendar day following the Department's receipt of written cancellation/termination notice. Surety shall remain firmly bound to all obligations herein for proposals submitted prior to the cancellation/termination. Surety shall be released and discharged from any obligation(s) for proposals submitted for any letting or date after the effective date of cancellation/termination.



Item No. \_\_\_\_\_

Letting Date \_\_\_\_\_

KNOW ALL PERSONS BY THESE PRESENTS, That We \_\_\_\_\_

as PRINCIPAL, and \_\_\_\_\_

as SURETY, and held jointly, severally and firmly bound unto the STATE OF ILLINOIS in the penal sum of 5 percent of the total bid price, or for the amount specified in the bid proposal under "Proposal Guaranty" in effect on the date of the Invitation for Bids, whichever is the lesser sum, well and truly to be paid unto said STATE OF ILLINOIS, for the payment of which we bind ourselves, our heirs, executors, administrators, successors and assigns.

THE CONDITION OF THE FOREGOING OBLIGATION IS SUCH that whereas, the PRINCIPAL has submitted a bid proposal to the STATE OF ILLINOIS, acting through the Department of Transportation, for the improvement designated by the Transportation Bulletin Item Number and Letting Date indicated above.

NOW, THEREFORE, if the Department shall accept the bid proposal of the PRINCIPAL; and if the PRINCIPAL shall, within the time and as specified in the bidding and contract documents; and if, after award by the Department, the PRINCIPAL shall enter into a contract in accordance with the terms of the bidding and contract documents including evidence of the required insurance coverages and providing such bond as specified with good and sufficient surety for the faithful performance of such contract and for the prompt payment of labor and material furnished in the prosecution thereof; or if, in the event of the failure of the PRINCIPAL to enter into such contract and to give the specified bond, the PRINCIPAL pays to the Department the difference not to exceed the penalty hereof between the amount specified in the bid proposal and such larger amount for which the Department may contract with another party to perform the work covered by said bid proposal, then this obligation shall be null and void, otherwise, it shall remain in full force and effect.

IN THE EVENT the Department determines the PRINCIPAL has failed to comply with any requirement as set forth in the preceding paragraph, then Surety shall pay the penal sum to the Department within fifteen (15) days of written demand therefor. If Surety does not make full payment within such period of time, the Department may bring an action to collect the amount owed. Surety is liable to the Department for all its expenses, including attorney's fees, incurred in any litigation in which it prevails either in whole or in part.

In TESTIMONY WHEREOF, the said PRINCIPAL has caused this instrument to be signed by its officer  
\_\_\_\_\_ day of \_\_\_\_\_ A.D., \_\_\_\_\_ .

In TESTIMONY WHEREOF, the said SURETY has caused this instrument to be signed by its officer  
\_\_\_\_\_ day of \_\_\_\_\_ A.D., \_\_\_\_\_ .

\_\_\_\_\_  
(Company Name)

\_\_\_\_\_  
(Company Name)

By \_\_\_\_\_  
(Signature and Title)

By \_\_\_\_\_  
(Signature of Attorney-in-Fact)

**Notary for PRINCIPAL**

**Notary for SURETY**

STATE OF \_\_\_\_\_  
COUNTY OF \_\_\_\_\_

STATE OF \_\_\_\_\_  
COUNTY OF \_\_\_\_\_

Signed and attested before me on \_\_\_\_\_ (date)  
by \_\_\_\_\_  
(Name of Notary Public)

Signed and attested before me on \_\_\_\_\_ (date)  
by \_\_\_\_\_  
(Name of Notary Public)

(Seal) \_\_\_\_\_  
(Signature of Notary Public)

(Seal) \_\_\_\_\_  
(Signature of Notary Public)

\_\_\_\_\_  
(Date Commission Expires)

\_\_\_\_\_  
(Date Commission Expires)

In lieu of completing the above section of the Proposal Bid Bond form, the Principal may file an Electronic Bid Bond. By signing the proposal the Principal is ensuring the identified electronic bid bond has been executed and the Principal and Surety are firmly bound unto the State of Illinois under the conditions of the bid bond as shown above.

Electronic Bid Bond ID # \_\_\_\_\_ Company/Bidder Name \_\_\_\_\_ Signature and Title \_\_\_\_\_





**(1) Policy**

It is public policy that disadvantageded businesses as defined in 49 CFR Part 26 and the Special Provision shall have the maximum opportunity to participate in the performance of contracts financed in whole or in part with Federal or State funds. Consequently the requirements of 49 CFR Part 26 apply to this contract.

**(2) Obligation**

The contractor agrees to ensure that disadvantageded businesses as defined in 49 CFR Part 26 and the Special Provision have the maximum opportunity to participate in the performance of contracts or subcontracts financed in whole or in part with Federal or State funds. The contractor shall take all necessary and reasonable steps in accordance with 49 CFR Part 26 and the Special Provision to ensure that said businesses have the maximum opportunity to compete for and perform under this contract. The contractor shall not discriminate on the basis of race, color, national origin or sex in the award and performance of contracts.

**(3) Project and Bid Identification**

Complete the following information concerning the project and bid:

Route \_\_\_\_\_

Section \_\_\_\_\_

Project \_\_\_\_\_

County \_\_\_\_\_

Letting Date \_\_\_\_\_

Contract No. \_\_\_\_\_

Letting Item No. \_\_\_\_\_

Total Bid \_\_\_\_\_

Contract DBE Goal \_\_\_\_\_

(Percent)                      (Dollar Amount)

**(4) Assurance**

I, acting in my capacity as an officer of the undersigned bidder (or bidders if a joint venture), hereby assure the Department that on this project my company : (check one)

- Meets or exceeds contract award goals and has provided documented participation as follows:  
Disadvantaged Business Participation \_\_\_\_\_ percent

Attached are the signed participation statements, forms SBE 2025, required by the Special Provision evidencing availability and use of each business participating in this plan and assuring that each business will perform a commercially useful function in the work of the contract.

- Failed to meet contract award goals and has included good faith effort documentation to meet the goals and that my company has provided participation as follows:  
Disadvantaged Business Participation \_\_\_\_\_ percent

The contract goals should be accordingly modified or waived. Attached is all information required by the Special Provision in support of this request including good faith effort. Also attached are the signed participation statements, forms SBE 2025, required by the Special Provision evidencing availability and use of each business participating in this plan and assuring that each business will perform a commercially useful function in the work of the contract.

\_\_\_\_\_ Company

By \_\_\_\_\_

Title \_\_\_\_\_

Date \_\_\_\_\_

The "as read" Low Bidder is required to comply with the Special Provision.

Submit only one utilization plan for each project. The utilization plan shall be submitted in accordance with the special provision.

Bureau of Small Business Enterprises                      **Local Let Projects**  
2300 South Dirksen Parkway                                      Submit forms to the  
Springfield, Illinois 62764    Local Agency

The Department of Transportation is requesting disclosure of information that is necessary to accomplish the purpose as outlined under State and Federal law. Disclosure of this information is **REQUIRED**. Failure to provide any information will result in the contract not being awarded. This form has been approved by the State Forms Manager Center.



# PROPOSAL ENVELOPE



# PROPOSALS

for construction work advertised for bids by the  
Illinois Department of Transportation

Item No.	Item No.	Item No.

Submitted By:

Name:
Address:
Phone No.

Bidders should use an IDOT proposal envelope or affix this form to the front of a 10" x 13" envelope for the submittal of bids. If proposals are mailed, they should be enclosed in a second or outer envelope addressed to:

Engineer of Design and Environment - Room 326  
Illinois Department of Transportation  
2300 South Dirksen Parkway  
Springfield, Illinois 62764

## **NOTICE**

**Individual bids, including Bid Bond and/or supplemental information if required, should be securely stapled.**

# CONTRACTOR OFFICE COPY OF CONTRACT SPECIFICATIONS

---

## NOTICE

None of the following material needs to be returned with the bid package unless the special provisions require documentation and/or other information to be submitted.

**Contract No. 64L37  
WINNEBAGO County  
Section 102RS-3  
Route FAS 55  
District 2 Construction Funds**



**Illinois Department of Transportation**

## **SUBCONTRACTOR DOCUMENTATION**

Public Acts 96-0795, 96-0920, and 97-0895 enacted substantial changes to the provisions of the Code (30 ILCS 500). Among the changes are provisions affecting subcontractors. The Contractor awarded this contract will be required as a material condition of the contract to implement and enforce the contract requirements applicable to subcontractors that entered into a contractual agreement with a total value of \$50,000 or more with a person or entity who has a contract subject to the Code and approved in accordance with article 108.01 of the Standard Specifications for Road and Bridge Construction.

If the Contractor seeks approval of subcontractors to perform a portion of the work, and approval is granted by the Department, the Contractor shall provide a copy of the subcontract to the Illinois Department of Transportation's CPO upon request within 15 calendar days after execution of the subcontract.

Financial disclosures required pursuant to Sec. 50-35 of the Code must be submitted for all applicable subcontractors. The subcontract shall contain the certifications required to be made by subcontractors pursuant to Article 50 of the Code. This Notice to Bidders includes a document incorporating all required subcontractor certifications and disclosures for use by the Contractor in compliance with this mandate. The document is entitled State Required Ethical Standards Governing Subcontractors.

## RETURN WITH SUBCONTRACT

### STATE ETHICAL STANDARDS GOVERNING SUBCONTRACTORS

Article 50 of the Code establishes the duty of all State CPOs, SPOs, and their designees to maximize the value of the expenditure of public moneys in procuring goods, services, and contracts for the State of Illinois and to act in a manner that maintains the integrity and public trust of State government. In discharging this duty, they are charged by law to use all available information, reasonable efforts, and reasonable actions to protect, safeguard, and maintain the procurement process of the State of Illinois.

The certifications hereinafter made by the subcontractor are each a material representation of fact upon which reliance is placed should the Department approve the subcontractor. The CPO may terminate or void the contract approval if it is later determined that the bidder or subcontractor rendered a false or erroneous certification. If a false certification is made by a subcontractor the contractor's submitted bid and the executed contract may not be declared void unless the contractor refuses to terminate the subcontract upon the State's request after a finding that the subcontractor's certification was false.

Section 50-2 of the Code provides that every person that has entered into a multi-year contract and every subcontractor with a multi-year subcontract shall certify, by July 1 of each fiscal year covered by the contract after the initial fiscal year, to the responsible CPO whether it continues to satisfy the requirements of Article 50 pertaining to the eligibility for a contract award. If a contractor or subcontractor is not able to truthfully certify that it continues to meet all requirements, it shall provide with its certification a detailed explanation of the circumstances leading to the change in certification status. A contractor or subcontractor that makes a false statement material to any given certification required under Article 50 is, in addition to any other penalties or consequences prescribed by law, subject to liability under the Whistleblower Reward and Protection Act for submission of a false claim.

#### **A. Bribery**

Section 50-5. Bribery.

(a) Prohibition. No person or business shall be awarded a contract or subcontract under this Code who:

(1) has been convicted under the laws of Illinois or any other state of bribery or attempting to bribe an officer or employee of the State of Illinois or any other state in that officer's or employee's official capacity; or

(2) has made an admission of guilt of that conduct that is a matter of record but has not been prosecuted for that conduct.

(b) Businesses. No business shall be barred from contracting with any unit of State or local government, or subcontracting under such a contract, as a result of a conviction under this Section of any employee or agent of the business if the employee or agent is no longer employed by the business and:

(1) the business has been finally adjudicated not guilty; or

(2) the business demonstrates to the governmental entity with which it seeks to contract, or which is signatory to the contract to which the subcontract relates, and that entity finds that the commission of the offense was not authorized, requested, commanded, or performed by a director, officer, or high managerial agent on behalf of the business as provided in paragraph (2) of subsection (a) of Section 5-4 of the Criminal Code of 2012.

(c) Conduct on behalf of business. For purposes of this Section, when an official, agent, or employee of a business committed the bribery or attempted bribery on behalf of the business and in accordance with the direction or authorization of a responsible official of the business, the business shall be chargeable with the conduct.

(d) Certification. Every bid submitted to and contract executed by the State, and every subcontract subject to Section 20-120 of the Code shall contain a certification by the contractor or the subcontractor, respectively, that the contractor or subcontractor is not barred from being awarded a contract or subcontract under this Section and acknowledges that the CPO may declare the related contract void if any certifications required by this Section are false. A contractor who makes a false statement, material to the certification, commits a Class 3 felony.

The contractor or subcontractor certifies that it is not barred from being awarded a contract under Section 50-5.

#### **B. Felons**

Section 50-10. Felons.

Unless otherwise provided, no person or business convicted of a felony shall do business with the State of Illinois or any State agency, or enter into a subcontract, from the date of conviction until 5 years after the date of completion of the sentence for that felony, unless no person held responsible by a prosecutorial office for the facts upon which the conviction was based continues to have any involvement with the business.

Certification. Every bid submitted to and contract executed by the State and every subcontract subject to Section 20-120 of the Code shall contain a certification by the bidder or contractor or subcontractor, respectively, that the bidder, contractor, or subcontractor is not barred from being awarded a contract or subcontract under this Section and acknowledges that the CPO may declare the related contract void if any of the certifications required by this Section are false.

## RETURN WITH SUBCONTRACT

### **C. Debt Delinquency**

Section 50-11 and 50-12. Debt Delinquency.

The contractor or bidder or subcontractor, respectively, certifies that it, or any affiliate, is not barred from being awarded a contract or subcontract under the Code. Section 50-11 prohibits a person from entering into a contract with a State agency, or entering into a subcontract, if it knows or should know that it, or any affiliate, is delinquent in the payment of any debt to the State as defined by the Debt Collection Board. Section 50-12 prohibits a person from entering into a contract with a State agency, or entering into a subcontract, if it, or any affiliate, has failed to collect and remit Illinois Use Tax on all sales of tangible personal property into the State of Illinois in accordance with the provisions of the Illinois Use Tax Act. The bidder or contractor or subcontractor, respectively, further acknowledges that the CPO may declare the related contract void if this certification is false or if the bidder, contractor, or subcontractor, or any affiliate, is determined to be delinquent in the payment of any debt to the State during the term of the contract.

### **D. Prohibited Bidders, Contractors and Subcontractors**

Section 50-10.5 and 50-60(c). Prohibited bidders, contractors and subcontractors.

The bidder or contractor or subcontractor, respectively, certifies in accordance with 30 ILCS 500/50-10.5 that no officer, director, partner or other managerial agent of the contracting business has been convicted of a felony under the Sarbanes-Oxley Act of 2002 or a Class 3 or Class 2 felony under the Illinois Securities Law of 1953 or if in violation of Subsection (c) for a period of five years from the date of conviction. Every bid submitted to and contract executed by the State and every subcontract subject to Section 20-120 of the Code shall contain a certification by the bidder, contractor, or subcontractor, respectively, that the bidder, contractor, or subcontractor is not barred from being awarded a contract or subcontract under this Section and acknowledges that the CPO shall declare the related contract void if any of the certifications completed pursuant to this Section are false.

### **E. Section 42 of the Environmental Protection Act**

The bidder or contractor or subcontractor, respectively, certifies in accordance with 30 ILCS 500/50-14 that the bidder, contractor, or subcontractor, is not barred from being awarded a contract or entering into a subcontract under this Section which prohibits the bidding on or entering into contracts with the State of Illinois or a State agency, or entering into any subcontract, that is subject to the Code by a person or business found by a court or the Pollution Control Board to have committed a willful or knowing violation of Section 42 of the Environmental Protection Act for a period of five years from the date of the order. The bidder or contractor or subcontractor, respectively, acknowledges that the CPO may declare the contract void if this certification is false.

**The undersigned, on behalf of the subcontracting company, has read and understands the above certifications and makes the certifications as required by law.**

\_\_\_\_\_  
Name of Subcontracting Company

\_\_\_\_\_  
Authorized Officer

\_\_\_\_\_  
Date

**RETURN WITH SUBCONTRACT**  
**SUBCONTRACTOR DISCLOSURES**

**I. DISCLOSURES**

- A.** The disclosures hereinafter made by the subcontractor are each a material representation of fact upon which reliance is placed. The subcontractor further certifies that the Department has received the disclosure forms for each subcontract.

The CPO may void the bid, contract, or subcontract, respectively, if it is later determined that the bidder or subcontractor rendered a false or erroneous disclosure. A contractor or subcontractor may be suspended or debarred for violations of the Code. Furthermore, the CPO may void the contract.

**B. Financial Interests and Conflicts of Interest**

1. Section 50-35 of the Code provides that all subcontracts with a total value of \$50,000 or more from subcontractors identified in Section 20-120 of the Code, shall be accompanied by disclosure of the financial interests of the subcontractor. This disclosed information for the subcontractor, will be maintained as public information subject to release by request pursuant to the Freedom of Information Act, filed with the Procurement Policy Board, and shall be incorporated as a material term of the Prime Contractor's contract. Furthermore, pursuant to this Section, the Procurement Policy Board may recommend to allow or void a contract or subcontract based on a potential conflict of interest.

The financial interests to be disclosed shall include ownership or distributive income share that is in excess of 5%, or an amount greater than 60% of the annual salary of the Governor, of the subcontracting entity or its parent entity, whichever is less, unless the subcontractor is a publicly traded entity subject to Federal 10K reporting, in which case it may submit its 10K disclosure in place of the prescribed disclosure. If a subcontractor is a privately held entity that is exempt from Federal 10K reporting, but has more than 100 shareholders, it may submit the information that Federal 10K companies are required to report, and list the names of any individual or entity holding any ownership share that is in excess of 5%. The disclosure shall include the names, addresses, and dollar or proportionate share of ownership of each individual making the disclosure, their instrument of ownership or beneficial relationship, and notice of any potential conflict of interest resulting from the current ownership or beneficial interest of each individual making the disclosure having any of the relationships identified in Section 50-35 and on the disclosure form.

**The current annual salary of the Governor is \$177,412.00.**

In addition, all disclosures shall indicate any other current or pending contracts, subcontracts, proposals, leases, or other ongoing procurement relationships the subcontracting entity has with any other unit of state government and shall clearly identify the unit and the contract, subcontract, proposal, lease, or other relationship.

2. Disclosure Forms. Disclosure Form A is attached for use concerning the individuals meeting the above ownership or distributive share requirements. A separate Disclosure Form A must be submitted with the bid for each individual meeting the above requirements. In addition, a second form (Disclosure Form B) provides for the disclosure of current or pending procurement relationships with other (non-IDOT) state agencies and a total ownership certification.

**C. Disclosure Form Instructions**

**Form A Instructions for Financial Information & Potential Conflicts of Interest**

If the subcontractor is a publicly traded entity subject to Federal 10K reporting, the 10K Report may be submitted to meet the requirements of Form A. If a subcontractor is a privately held entity that is exempt from Federal 10K reporting, but has more than 100 shareholders, it may submit the information that Federal 10K companies are required to report, and list the names of any individual or entity holding any ownership share that is in excess of 5%. If a subcontractor is not subject to Federal 10K reporting, the subcontractor must determine if any individuals are required by law to complete a financial disclosure form. To do this, the subcontractor should answer each of the following questions. A "YES" answer indicates Form A must be completed. If the answer to each of the following questions is "NO", then the NOT APPLICABLE STATEMENT on the second page of Form A must be signed and dated by an individual that is authorized to execute contracts for the subcontracting company. Note: These questions are for assistance only and are not required to be completed.

1. Does anyone in your organization have a direct or beneficial ownership share of greater than 5% of the bidding entity or parent entity? YES \_\_\_ NO \_\_\_
2. Does anyone in your organization have a direct or beneficial ownership share of less than 5%, but which has a value greater than 60% of the annual salary of the Governor? YES \_\_\_ NO \_\_\_
3. Does anyone in your organization receive more than 60% of the annual salary of the Governor of the subcontracting entity's or parent entity's distributive income? YES \_\_\_ NO \_\_\_

(Note: Distributive income is, for these purposes, any type of distribution of profits. An annual salary is not distributive income.)

4. Does anyone in your organization receive greater than 5% of the subcontracting entity's or parent entity's total distributive income, but which is less than 60% of the annual salary of the Governor? YES \_\_\_ NO \_\_\_

(Note: Only one set of forms needs to be completed per individual per subcontract even if a specific individual would require a yes answer to more than one question.)

A "YES" answer to any of these questions requires the completion of Form A. The subcontractor must determine each individual in the subcontracting entity or the subcontracting entity's parent company that would cause the questions to be answered "Yes". Each form must be signed and dated by an individual that is authorized to execute contracts for your organization. The individual signing can be, but does not have to be, the individual for which the form is being completed. The subcontractor is responsible for the accuracy of any information provided.

If the answer to each of the above questions is "NO", then the NOT APPLICABLE STATEMENT on page 2 of Form A must be signed and dated by an individual that is authorized to execute contracts for your company.



## RETURN WITH SUBCONTRACT

### **Form B: Instructions for Identifying Other Contracts & Procurement Related Information**

Disclosure Form B must be completed for each subcontract submitted by the subcontracting entity. *Note: Checking the NOT APPLICABLE STATEMENT on Form A does not allow the subcontractor to ignore Form B. Form B must be completed, checked, and dated or the subcontract will not be approved.*

The Subcontractor shall identify, by checking Yes or No on Form B, whether it has any pending contracts, subcontracts, leases, bids, proposals, or other ongoing procurement relationship with any other (non-IDOT) State of Illinois agency. If "No" is checked, the subcontractor only needs to complete the check box on the bottom of Form B. If "Yes" is checked, the subcontractor must list all non-IDOT State of Illinois agency pending contracts, subcontracts, leases, bids, proposals, and other ongoing procurement relationships. These items may be listed on Form B or on an attached sheet(s). Contracts with cities, counties, villages, etc. are not considered State of Illinois agency contracts and are not to be included. Contracts or subcontracts with other State of Illinois agencies such as the Department of Natural Resources or the Capital Development Board must be included.

RETURN WITH SUBCONTRACT

ILLINOIS DEPARTMENT OF TRANSPORTATION

Form A Subcontractor: Financial Information & Potential Conflicts of Interest Disclosure

Subcontractor Name, Legal Address, City, State, Zip, Telephone Number, Email Address, Fax Number (if available)

Disclosure of the information contained in this Form is required by Section 50-35 of the Code (30 ILCS 500). Subcontractors desiring to enter into a subcontract of a State of Illinois contract must disclose the financial information and potential conflict of interest information as specified in this Disclosure Form.

The current annual salary of the Governor is \$177,412.00.

DISCLOSURE OF FINANCIAL INFORMATION

1. Disclosure of Financial Information. The individual named below has an interest in the SUBCONTRACTOR (or its parent) in terms of ownership or distributive income share in excess of 5%, or an interest which has a value of more than 60% of the annual salary of the Governor.

FOR INDIVIDUAL (type or print information) NAME: ADDRESS Type of ownership/distributable income share: stock sole proprietorship Partnership other: (explain on separate sheet): % or \$ value of ownership/distributable income share:

2. Disclosure of Potential Conflicts of Interest. Check "Yes" or "No" to indicate which, if any, of the following potential conflict of interest relationships apply. If the answer to any question is "Yes", please attach additional pages and describe.

(a) State employment, currently or in the previous 3 years, including contractual employment of services. Yes \_\_\_ No \_\_\_

If your answer is yes, please answer each of the following questions.

1. Are you currently an officer or employee of either the Capitol Development Board or the Illinois State Toll Highway Authority? Yes \_\_\_ No \_\_\_

2. Are you currently appointed to or employed by any agency of the State of Illinois? If you are currently appointed to or employed by any agency of the State of Illinois, and your annual salary exceeds 60% of the annual salary of the Governor, provide the name the State agency for which you are employed and your annual salary.

**RETURN WITH SUBCONTRACT**

3. If you are currently appointed to or employed by any agency of the State of Illinois, and your annual salary exceeds 60% of the annual salary of the Governor, are you entitled to receive (i) more than 7 1/2% of the total distributable income of your firm, partnership, association or corporation, or (ii) an amount in excess of 100% of the annual salary of the Governor?  
Yes \_\_\_ No \_\_\_

4. If you are currently appointed to or employed by any agency of the State of Illinois, and your annual salary exceeds 60% of the annual salary of the Governor, are you and your spouse or minor children entitled to receive (i) more than 15 % in the aggregate of the total distributable income of your firm, partnership, association or corporation, or (ii) an amount in excess of two times the salary of the Governor?  
Yes \_\_\_ No \_\_\_

---

(b) State employment of spouse, father, mother, son, or daughter, including contractual employment services in the previous 2 years.

Yes \_\_\_ No \_\_\_

If your answer is yes, please answer each of the following questions.

1. Is your spouse or any minor children currently an officer or employee of the Capitol Development Board or the Illinois Toll Highway Authority?  
Yes \_\_\_ No \_\_\_

2. Is your spouse or any minor children currently appointed to or employed by any agency of the State of Illinois? If your spouse or minor children is/are currently appointed to or employed by any agency of the State of Illinois, and his/her annual salary exceeds 60% of the annual salary of the Governor, provide the name of your spouse and/or minor children, the name of the State agency for which he/she is employed and his/her annual salary. \_\_\_\_\_

3. If your spouse or any minor children is/are currently appointed to or employed by any agency of the State of Illinois, and his/her annual salary exceeds 60% of the annual salary of the Governor, as of 7/1/07) are you entitled to receive (i) more then 7 1/2% of the total distributable income of your firm, partnership, association or corporation, or (ii) an amount in excess of 100% of the annual salary of the Governor?  
Yes \_\_\_ No \_\_\_

4. If your spouse or any minor children are currently appointed to or employed by any agency of the State of Illinois, and his/her annual salary exceeds 60% of the annual salary of the Governor, are you and your spouse or minor children entitled to receive (i) more than 15 % in the aggregate of the total distributable income of your firm, partnership, association or corporation, or (ii) an amount in excess of two times the annual salary of the Governor?  
Yes \_\_\_ No \_\_\_

---

(c) Elective status; the holding of elective office of the State of Illinois, the government of the United States, any unit of local government authorized by the Constitution of the State of Illinois or the statutes of the State of Illinois currently or in the previous 3 years.  
Yes \_\_\_ No \_\_\_

---

(d) Relationship to anyone holding elective office currently or in the previous 2 years; spouse, father, mother, son, or daughter.  
Yes \_\_\_ No \_\_\_

---

(e) Appointive office; the holding of any appointive government office of the State of Illinois, the United States of America, or any unit of local government authorized by the Constitution of the State of Illinois or the statutes of the State of Illinois, which office entitles the holder to compensation in excess of the expenses incurred in the discharge of that office currently or in the previous 3 years.  
Yes \_\_\_ No \_\_\_

---

(f) Relationship to anyone holding appointive office currently or in the previous 2 years; spouse, father, mother, son, or daughter.  
Yes \_\_\_ No \_\_\_

---

(g) Employment, currently or in the previous 3 years, as or by any registered lobbyist of the State government.  
Yes \_\_\_ No \_\_\_

**RETURN WITH SUBCONTRACT**

(h) Relationship to anyone who is or was a registered lobbyist in the previous 2 years; spouse, father, mother, son, or daughter. Yes \_\_\_ No \_\_\_

(i) Compensated employment, currently or in the previous 3 years, by any registered election or reelection committee registered with the Secretary of State or any county clerk of the State of Illinois, or any political action committee registered with either the Secretary of State or the Federal Board of Elections. Yes \_\_\_ No \_\_\_

(j) Relationship to anyone; spouse, father, mother, son, or daughter; who was a compensated employee in the last 2 years by any registered election or re-election committee registered with the Secretary of State or any county clerk of the State of Illinois, or any political action committee registered with either the Secretary of State or the Federal Board of Elections. Yes \_\_\_ No \_\_\_

**3 Communication Disclosure.**

Disclose the name and address of each lobbyist and other agent of the bidder or offeror who is not identified in Section 2 of this form, who is has communicated, is communicating, or may communicate with any State officer or employee concerning the bid or offer. This disclosure is a continuing obligation and must be promptly supplemented for accuracy throughout the process and throughout the term of the contract. If no person is identified, enter "None" on the line below:

Name and address of person(s): \_\_\_\_\_  
\_\_\_\_\_  
\_\_\_\_\_  
\_\_\_\_\_

**RETURN WITH SUBCONTRACT**

**4. Suspension or Debarment Disclosure.** For each of the persons identified under Sections 2 and 3 of this form, disclose whether any of the following has occurred within the previous 10 years: suspension or debarment from contracting with any governmental entity; professional licensure discipline; bankruptcies; adverse civil judgments and administrative findings; and criminal felony convictions. This disclosure is a continuing obligation and must be promptly supplemented for accuracy throughout the procurement process and term of the contract. If no person is identified, enter "None" on the line below:

Name of person(s): \_\_\_\_\_

Nature of disclosure: \_\_\_\_\_  
\_\_\_\_\_  
\_\_\_\_\_

**APPLICABLE STATEMENT**

**This Disclosure Form A is submitted on behalf of the INDIVIDUAL named on previous page. Under penalty of perjury, I certify the contents of this disclosure to be true and accurate to the best of my knowledge.**

Completed by:  \_\_\_\_\_ Date \_\_\_\_\_  
Signature of Individual or Authorized Officer

**NOT APPLICABLE STATEMENT**

**Under penalty of perjury, I have determined that no individuals associated with this organization meet the criteria that would require the completion of this Form A.**

**This Disclosure Form A is submitted on behalf of the SUBCONTRACTOR listed on the previous page.**

\_\_\_\_\_ Date \_\_\_\_\_  
Signature of Authorized Officer

RETURN WITH SUBCONTRACT

ILLINOIS DEPARTMENT OF TRANSPORTATION

Form B
Subcontractor: Other Contracts & Financial Related Information Disclosure

Form with fields: Subcontractor Name, Legal Address, City, State, Zip, Telephone Number, Email Address, Fax Number (if available)

Disclosure of the information contained in this Form is required by Section 50-35 of the Code (30 ILCS 500). This information shall become part of the publicly available contract file. This Form B must be completed for subcontracts with a total value of \$50,000 or more, from subcontractors identified in Section 20-120 of the Code, and for all open-ended contracts.

DISCLOSURE OF OTHER CONTRACTS, SUBCONTRACTS, AND PROCUREMENT RELATED INFORMATION

1. Identifying Other Contracts & Procurement Related Information. The SUBCONTRACTOR shall identify whether it has any pending contracts, subcontracts, including leases, bids, proposals, or other ongoing procurement relationship with any other State of Illinois agency: Yes \_\_\_ No \_\_\_

If "No" is checked, the subcontractor only needs to complete the signature box on this page.

2. If "Yes" is checked. Identify each such relationship by showing State of Illinois agency name and other descriptive information such as bid or project number (attach additional pages as necessary). SEE DISCLOSURE FORM INSTRUCTIONS:

THE FOLLOWING STATEMENT MUST BE CHECKED

Signature box with fields: Signature of Authorized Representative, Date

OWNERSHIP CERTIFICATION

Please certify that the following statement is true if the individuals for all submitted Form A disclosures do not total 100% of ownership

Any remaining ownership interest is held by individuals receiving less than \$106,447.20 of the bidding entity's or parent entity's distributive income or holding less than a 5% ownership interest.

Yes No N/A (Form A disclosure(s) established 100% ownership)



- 1. TIME AND PLACE OF OPENING BIDS.** Sealed proposals for the improvement described herein will be received by the Department of Transportation. Electronic bids are to be submitted to the electronic bidding system (iCX-Integrated Contractors Exchange). Paper-based bids are to be submitted to the Chief Procurement Officer for the Department of Transportation in care of the Chief Contracts Official at the Harry R. Hanley Building, 2300 South Dirksen Parkway, in Springfield, Illinois until 10:00 a.m. June 10, 2016. All bids will be gathered, sorted, publicly opened and read in the auditorium at the Department of Transportation's Harry R. Hanley Building shortly after 10:00 a.m.
- 2. DESCRIPTION OF WORK.** The proposed improvement is identified and advertised for bids in the Invitation for Bids as:

**Contract No. 64L37  
WINNEBAGO County  
Section 102RS-3  
Route FAS 55  
District 2 Construction Funds**

**This project consists of raised reflective pavement marker (RRPM) removal and replacement, Cape Seal application, temporary RRPM application and removal, paint and thermoplastic pavement marking removal and replacement for 6.47 miles on IL 70 from 0.20 miles south of IL 75 to the Pecatonica River.**

- 3. INSTRUCTIONS TO BIDDERS.** (a) This Notice, the invitation for bids, proposal and letter of award shall, together with all other documents in accordance with Article 101.09 of the Standard Specifications for Road and Bridge Construction, become part of the contract. Bidders are cautioned to read and examine carefully all documents, to make all required inspections, and to inquire or seek explanation of the same prior to submission of a bid.  
  
(b) State law, and, if the work is to be paid wholly or in part with Federal-aid funds, Federal law requires the bidder to make various certifications as a part of the proposal and contract. By execution and submission of the proposal, the bidder makes the certification contained therein. A false or fraudulent certification shall, in addition to all other remedies provided by law, be a breach of contract and may result in termination of the contract.
- 4. AWARD CRITERIA AND REJECTION OF BIDS.** This contract will be awarded to the lowest responsive and responsible bidder considering conformity with the terms and conditions established by the Department in the rules, Invitation for Bids and contract documents. The issuance of plans and proposal forms for bidding based upon a prequalification rating shall not be the sole determinant of responsibility. The Department reserves the right to determine responsibility at the time of award, to reject any or all proposals, to readvertise the proposed improvement, and to waive technicalities.

By Order of the  
Illinois Department of Transportation

Randall S. Blankenhorn,  
Secretary

INDEX  
FOR  
SUPPLEMENTAL SPECIFICATIONS  
AND RECURRING SPECIAL PROVISIONS

Adopted April 1, 2016

This index contains a listing of SUPPLEMENTAL SPECIFICATIONS, frequently used RECURRING SPECIAL PROVISIONS, and LOCAL ROADS AND STREETS RECURRING SPECIAL PROVISIONS.

No ERRATA this year.

SUPPLEMENTAL SPECIFICATIONS

Std. Spec. Sec.

Page No.

No Supplemental Specifications this year.



RECURRING SPECIAL PROVISIONS

The following RECURRING SPECIAL PROVISIONS indicated by an "X" are applicable to this contract and are included by reference:

<u>CHECK SHEET #</u>		<u>PAGE NO.</u>
1	Additional State Requirements for Federal-Aid Construction Contracts .....	1
2	Subletting of Contracts (Federal-Aid Contracts) .....	4
3	<b>X</b> EEO .....	5
4	<b>X</b> Specific EEO Responsibilities Non Federal-Aid Contracts .....	15
5	<b>X</b> Required Provisions - State Contracts .....	20
6	Asbestos Bearing Pad Removal .....	26
7	Asbestos Waterproofing Membrane and Asbestos HMA Surface Removal .....	27
8	Temporary Stream Crossings and In-Stream Work Pads .....	28
9	Construction Layout Stakes Except for Bridges .....	29
10	Construction Layout Stakes .....	32
11	Use of Geotextile Fabric for Railroad Crossing .....	35
12	Subsealing of Concrete Pavements .....	37
13	Hot-Mix Asphalt Surface Correction .....	41
14	Pavement and Shoulder Resurfacing .....	43
15	Patching with Hot-Mix Asphalt Overlay Removal .....	44
16	Polymer Concrete .....	45
17	PVC Pipeliner .....	47
18	Bicycle Racks .....	48
19	Temporary Portable Bridge Traffic Signals .....	50
20	Work Zone Public Information Signs .....	52
21	Nighttime Inspection of Roadway Lighting .....	53
22	English Substitution of Metric Bolts .....	54
23	Calcium Chloride Accelerator for Portland Cement Concrete .....	55
24	Quality Control of Concrete Mixtures at the Plant .....	56
25	Quality Control/Quality Assurance of Concrete Mixtures .....	64
26	Digital Terrain Modeling for Earthwork Calculations .....	80
27	<b>X</b> Pavement Marking Removal .....	82
28	Preventive Maintenance – Bituminous Surface Treatment .....	83
29	<b>X</b> Preventive Maintenance – Cape Seal .....	89
30	Preventive Maintenance – Micro-Surfacing .....	104
31	Preventive Maintenance – Slurry Seal .....	115
32	<b>X</b> Temporary Raised Pavement Markers .....	125
33	Restoring Bridge Approach Pavements Using High-Density Foam .....	126

## TABLE OF CONTENTS

LOCATION OF PROJECT .....	1
DESCRIPTION OF PROJECT .....	1
TRAFFIC CONTROL PLAN .....	1
WORK ZONE PAVEMENT MARKING AND REMOVAL .....	4
AUTOMATED FLAGGER ASSISTANCE DEVICES (BDE).....	4
COARSE AGGREGATE QUALITY (BDE).....	5
DISADVANTAGED BUSINESS ENTERPRISE PARTICIPATION (BDE) .....	7
EQUAL EMPLOYMENT OPPORTUNITY (BDE).....	17
ERRATA FOR THE 2016 STANDARD SPECIFICATIONS (BDE).....	19
PROGRESS PAYMENTS (BDE) .....	23
RECLAIMED ASPHALT PAVEMENT AND RECLAIMED ASPHALT SHINGLES (BDE) .....	23
WARM MIX ASPHALT (BDE) .....	32
WEEKLY DBE TRUCKING REPORTS (BDE).....	33
WORKING DAYS (BDE) .....	34
BITUMINOUS MATERIALS COST ADJUSTMENTS (BDE) (RETURN FORM WITH BID).....	34
VETERAN BUSINESS PROGRAM .....	37

## STATE OF ILLINOIS

---

### SPECIAL PROVISIONS

The following Special Provisions supplement the “Standard Specifications for Road and Bridge Construction, Adopted April 1, 2016”, the latest edition of the “Manual on Uniform Traffic Control Devices for Streets and Highways”, and the “Manual of Test Procedures for Materials” in effect on the date of invitation for bids, and the “Supplemental Specifications and Recurring Special Provisions” indicated on the Check Sheet included herein, which apply to and govern the construction of FAS Route 55 (IL 70), Section 102 RS-3, Winnebago County, Contract No. 64L37 and, in case of conflict with any part, or parts, of said Specifications, the said Special Provisions shall take precedence and shall govern.

#### LOCATION OF PROJECT

The project is located on FAS 55 (IL 70) 0.20 miles south of IL 75 and extends to the Pecatonica River.

#### DESCRIPTION OF PROJECT

The project consists of cape sealing the mainline driving lanes and left turn lanes. Additional work includes removal and replacement of raised reflective pavement markers (RRPM's), and pavement markings (paint & thermoplastic).

#### TRAFFIC CONTROL PLAN

Effective: January 14, 1999

Revised: December 29, 2015

Traffic Control shall be according to the applicable sections of the Standard Specifications for Road and Bridge Construction, the applicable guidelines contained in the National Manual on Uniform Traffic Control Devices for Streets and Highways, Illinois Supplement to the National Manual on Uniform Traffic Control Devices, these special provisions, and any special details and Highway Standards contained herein and in the plans.

Special attention is called to Articles 107.09 and 107.14 of the Standard Specifications for Road and Bridge Construction and the following Highway Standards relating to traffic control.

#### Standards:

701006    701011    701201    701301    701306    701311    701901

#### Details:

Typical Pavement Marking (District Standard 41.1)

General:

Where construction activities involve sidewalks on both sides of the street, the work shall be staged so that both sidewalks are not out of service at the same time.

Signs:

No bracing shall be allowed on post-mounted signs.

Post-mounted signs shall be installed using standard 720011, 728001, 729001, on 4"x4" wood posts, or on any other "break away" connection if accepted by the FHWA and corresponding letter is provided to the resident.

When covering existing Department signs, no tape shall be used on the reflective portion of the sign. Contact the District sign shop for covering techniques.

All regulatory signs shall be maintained at a 5 foot minimum bottom (rural), 7 foot minimum (urban).

Any plates or direct applied sheeting used to alter signs shall have the same sheeting as the base sign.

No more than one kind of alteration shall be used to alter a sign.

Any post stubs without a sign in place and visible shall have a reflector placed on each post.

The LOOSE GRAVEL (W8-7(O)48) signs with an advisory speed of 35 mph (W13-1(O)2424) shall be erected when the aggregate has been placed and the road is open to traffic. The signs shall remain in place until the excess aggregate is swept and the condition no longer exists. These signs shall be erected a minimum of 500 feet preceding the start of the condition and shall have an amber flashing light attached if up during hours of darkness.

Devices:

Cones or reflectorized cones shall not be used during hours of darkness.

A minimum of 3 drums spaced at 4 feet shall be placed at each return when the sideroad is open.

On all standards and devices listed in Section 701 of the Standard Specifications, the device spacing shall be revised to the following dimensions:

- Where the spacing shown on the standard is 25 feet, the devices shall be placed at 20 feet.
- Where the spacing shown on the standard is 50 feet, the devices shall be placed at 40 feet.
- Where the spacing shown on the standard is 100 feet, the devices shall be placed at 80 feet.

Flaggers:

Flagger at Sideroads and Commercial Entrances:

Effective: August 1, 2011

Revised: December 29, 2015

Flaggers shall comply with all requirements and signaling methods contained in the Department's "Flagger Handbook" dated September 2011.

The flagger equipment listed for flaggers employed by the Illinois Department of Transportation shall apply to all flaggers

All workers and flaggers shall wear ANSI Class E pants and an ANSI Class 2 vest that in combination meet the requirements of ANSI/ISEA 107-2004 for Conspicuity Class 3 garments during hours of darkness.

In addition to the flaggers shown on applicable standards, on major sideroads, flaggers shall be required on all legs of the intersection. Major sideroads for this project shall be Trask Bridge Road and Leech Road.

In addition to the flaggers shown on applicable standards, a flagger shall be required on high volume commercial entrances listed below. High volume commercial entrances for this project shall be none.

When the mainline flagger is within 200 feet of an intersection, the sideroad flagger shall be required.

When the road is closed to through traffic and it is necessary to provide access for local traffic, all flaggers as shown on the applicable standards will be required. No reduction in the number of flaggers shall be allowed.

Revise Article 701.20(i) of the Standard Specifications to read:

“Signs, barricades, other traffic control devices, or flaggers required by the Engineer, over and above those shown in the contract documents, will be paid for according to Article 109.04.”

Pavement Marking:

All temporary pavement markings that will be operational during the winter months (December through March) shall be paint.

Temporary pavement markings shall not be included in the cost of the standard rather it shall be paid for separately at the contract unit prices of specified temporary pavement marking items.

Pilot Car: During the cape seal operation, the Contractor shall be required to provide a pilot car to lead the traffic through the areas primed.

The pilot car shall be a pickup truck, carrying the Contractor's company insignia, equipped with “PILOT CAR - FOLLOW ME” (G-20-4(0)) signs. Two signs shall be mounted on the vehicle so as to be clearly visible from both directions. The bottom of the sign shall be mounted at least 1 foot above the top of the cab. The pilot car shall be equipped with a two-way radio so normal communication with the flagger at each end of the work area can be maintained.

The pilot car shall be paid for by the day. If the pilot car is used less than four hours, the operation will be counted as a half day.

This work will be paid for at the contract unit price per Day for PILOT CAR for each car required by the Engineer.

Maintenance of Traffic: The mainline shall be kept open to one-way traffic at all times during working hours and two-way traffic during non-working hours.

Placing and removing pavement marking shall be completed using Traffic Control and Protection Standard 701306 or 701311.

## **WORK ZONE PAVEMENT MARKING AND REMOVAL**

Effective: December 29, 2008

This work shall consist of installing and removing temporary pavement marking according to Section 703 of the Standard Specifications and the following:

Paint pavement marking shall be used on the final wearing surface when the temporary pavement marking will conflict with the permanent pavement marking such as on tapers, crossovers and lane shifts.

All temporary paint on the final wearing surface shall be removed according to Article 1101.12 Water Blaster with Vacuum Recovery and the applicable portions of Section 703 of the Standard Specifications and as described herein.

Add the following paragraph to Article 1101.12 of the Standard Specifications.

For the high pressure water spray, the pressure at the nozzle shall be approximately 25,000 psi with maximum flow rate of 15 gal/min. The nozzle shall be in close proximity to the pavement surface.

## **AUTOMATED FLAGGER ASSISTANCE DEVICES (BDE)**

Effective: January 1, 2008

Description. This work shall consist of furnishing and operating automated flagger assistance devices (AFADs) as part of the work zone traffic control and protection for two-lane highways where two-way traffic is maintained over one lane of pavement. Use of these devices shall be at the option of the Contractor.

Equipment. AFADs shall be according to the FHWA memorandum, "MUTCD - Revised Interim Approval for the use of Automated Flagger Assistance Devices in Temporary Traffic Control Zones (IA-4R)", dated January 28, 2005. The devices shall be mounted on a trailer or a moveable cart and shall meet the requirements of NCHRP 350, Category 4.

The AFAD shall be the Stop/Slow type. This device uses remotely controlled "STOP" and "SLOW" signs to alternately control right-of-way.

Signs for the AFAD shall be according to Article 701.03 of the Standard Specifications and the MUTCD. The signs shall be 24 x 24 in. (600 x 600 mm) having an octagon shaped "STOP" sign on one side and a diamond shaped "SLOW" sign on the opposite side. The letters on the signs shall be 8 in. (200 mm) high. If the "STOP" sign has louvers, the full sign face shall be visible at a distance of 50 ft (15 m) and greater.

The signs shall be supplemented with one of the following types of lights.

- (a) Flashing Lights. When flashing lights are used, white or red flashing lights shall be mounted within the "STOP" sign face and white or yellow flashing lights within the "SLOW" sign face.
- (b) Stop and Warning Beacons. When beacons are used, a stop beacon shall be mounted 24 in. (600 mm) or less above the "STOP" sign face and a warning beacon mounted 24 in. (600 mm) or less above, below, or to the side of the "SLOW" sign face. As an option, a Type B warning light may be used in lieu of the warning beacon.

A "WAIT ON STOP" sign shall be placed on the right hand side of the roadway at a point where drivers are expected to stop. The sign shall be 24 x 30 in. (600 x 750 mm) with a black legend and border on a white background. The letters shall be at least 6 in. (150 mm) high.

This device may include a gate arm or mast arm that descends to a horizontal position when the "STOP" sign is displayed and rises to a vertical position when the "SLOW" sign is displayed. When included, the end of the arm shall reach at least to the center of the lane being controlled. The arm shall have alternating red and white retroreflective stripes, on both sides, sloping downward at 45 degrees toward the side on which traffic will pass. The stripes shall be 6 in. (150 mm) in width and at least 2 in. (50 mm) in height.

Flagging Requirements. Flaggers and flagging requirements shall be according to Article 701.13 of the Standard Specifications and the following.

AFADs shall be placed at each end of the traffic control, where a flagger is shown on the plans. The flaggers shall be able to view the face of the AFAD and approaching traffic during operation.

To stop traffic, the "STOP" sign shall be displayed, the corresponding lights/beacon shall flash, and when included, the gate arm shall descend to a horizontal position. To permit traffic to move, the "SLOW" sign shall be displayed, the corresponding lights/beacon shall flash, and when included, the gate arm shall rise to a vertical position.

If used at night, the AFAD location shall be illuminated according to Section 701 of the Standard Specifications.

When not in use, AFADs will be considered nonoperating equipment and shall be stored according to Article 701.11 of the Standard Specifications.

Basis of Payment. This work will not be paid for separately but shall be considered as included in the cost of the various traffic control items included in the contract.

## **COARSE AGGREGATE QUALITY (BDE)**

Effective: July 1, 2015

Revise Article 1004.01(b) of the Standard Specifications to read:

- "(b) Quality. The coarse aggregate shall be according to the quality standards listed in the following table.

COARSE AGGREGATE QUALITY				
QUALITY TEST	CLASS			
	A	B	C	D
Na <sub>2</sub> SO <sub>4</sub> Soundness 5 Cycle, ITP 104 <sup>1/</sup> , % Loss max.	15	15	20	25 <sup>2/</sup>
Los Angeles Abrasion, ITP 96 <sup>11/</sup> , % Loss max.	40 <sup>3/</sup>	40 <sup>4/</sup>	40 <sup>5/</sup>	45
Minus No. 200 (75 μm) Sieve Material, ITP 11	1.0 <sup>6/</sup>	---	2.5 <sup>7/</sup>	---
Deleterious Materials <sup>10/</sup>				
Shale, % max.	1.0	2.0	4.0 <sup>8/</sup>	---
Clay Lumps, % max.	0.25	0.5	0.5 <sup>8/</sup>	---
Coal & Lignite, % max.	0.25	---	---	---
Soft & Unsound Fragments, % max.	4.0	6.0	8.0 <sup>8/</sup>	---
Other Deleterious, % max.	4.0 <sup>9/</sup>	2.0	2.0 <sup>8/</sup>	---
Total Deleterious, % max.	5.0	6.0	10.0 <sup>8/</sup>	---
Oil-Stained Aggregate <sup>10/</sup> , % max	5.0	---	---	

1/ Does not apply to crushed concrete.

2/ For aggregate surface course and aggregate shoulders, the maximum percent loss shall be 30.

3/ For portland cement concrete, the maximum percent loss shall be 45.

4/ Does not apply to crushed slag or crushed steel slag.

5/ For hot-mix asphalt (HMA) binder mixtures, except when used as surface course, the maximum percent loss shall be 45.

6/ For crushed aggregate, if the material finer than the No. 200 (75 μm) sieve consists of the dust from fracture, essentially free from clay or silt, this percentage may be increased to 2.5.

7/ Does not apply to aggregates for HMA binder mixtures.

8/ Does not apply to Class A seal and cover coats.

9/ Includes deleterious chert. In gravel and crushed gravel aggregate, deleterious chert shall be the lightweight fraction separated in a 2.35 heavy media separation. In crushed stone aggregate, deleterious chert shall be the lightweight fraction separated in a 2.55 heavy media separation. Tests shall be run according to ITP 113.

10/ Test shall be run according to ITP 203.



11/ Does not apply to crushed slag.

All varieties of chert contained in gravel coarse aggregate for portland cement concrete, whether crushed or uncrushed, pure or impure, and irrespective of color, will be classed as chert and shall not be present in the total aggregate in excess of 25 percent by weight (mass).

Aggregates used in Class BS concrete (except when poured on subgrade), Class PS concrete, and Class PC concrete (bridge superstructure products only, excluding the approach slab) shall contain no more than two percent by weight (mass) of deleterious materials. Deleterious materials shall include substances whose disintegration is accompanied by an increase in volume which may cause spalling of the concrete.”

### **DISADVANTAGED BUSINESS ENTERPRISE PARTICIPATION (BDE)**

Effective: September 1, 2000

Revised: January 2, 2016

FEDERAL OBLIGATION. The Department of Transportation, as a recipient of federal financial assistance, is required to take all necessary and reasonable steps to ensure nondiscrimination in the award and administration of contracts. Consequently, the federal regulatory provisions of 49 CFR Part 26 apply to this contract concerning the utilization of disadvantaged business enterprises. For the purposes of this Special Provision, a disadvantaged business enterprise (DBE) means a business certified by the Department in accordance with the requirements of 49 CFR Part 26 and listed in the Illinois Unified Certification Program (IL UCP) DBE Directory.

STATE OBLIGATION. This Special Provision will also be used by the Department to satisfy the requirements of the Business Enterprise for Minorities, Females, and Persons with Disabilities Act, 30 ILCS 575. When this Special Provision is used to satisfy state law requirements on 100 percent state-funded contracts, the federal government has no involvement in such contracts (not a federal-aid contract) and no responsibility to oversee the implementation of this Special Provision by the Department on those contracts. DBE participation on 100 percent state-funded contracts will not be credited toward fulfilling the Department’s annual overall DBE goal required by the US Department of Transportation to comply with the federal DBE program requirements.

CONTRACTOR ASSURANCE. The Contractor makes the following assurance and agrees to include the assurance in each subcontract that the Contractor signs with a subcontractor.

The Contractor, subrecipient, or subcontractor shall not discriminate on the basis of race, color, national origin, or sex in the performance of this contract. The Contractor shall carry out applicable requirements of 49 CFR Part 26 in the award and administration of contracts funded in whole or in part with federal or state funds. Failure by the Contractor to carry out these requirements is a material breach of this contract, which may result in the termination of this contract or such other remedy as the recipient deems appropriate, which may include, but is not limited to:

- (a) Withholding progress payments;
- (b) Assessing sanctions;

(c) Liquidated damages; and/or

(d) Disqualifying the Contractor from future bidding as non-responsible.

OVERALL GOAL SET FOR THE DEPARTMENT. As a requirement of compliance with 49 CFR Part 26, the Department has set an overall goal for DBE participation in its federally assisted contracts. That goal applies to all federal-aid funds the Department will expend in its federally assisted contracts for the subject reporting fiscal year. The Department is required to make a good faith effort to achieve the overall goal. The dollar amount paid to all approved DBE companies performing work called for in this contract is eligible to be credited toward fulfillment of the Department's overall goal.

CONTRACT GOAL TO BE ACHIEVED BY THE CONTRACTOR. This contract includes a specific DBE utilization goal established by the Department. The goal has been included because the Department has determined that the work of this contract has subcontracting opportunities that may be suitable for performance by DBE companies. The determination is based on an assessment of the type of work, the location of the work, and the availability of DBE companies to do a part of the work. The assessment indicates that, in the absence of unlawful discrimination, and in an arena of fair and open competition, DBE companies can be expected to perform 6.00% of the work. This percentage is set as the DBE participation goal for this contract. Consequently, in addition to the other award criteria established for this contract, the Department will only award this contract to a bidder who makes a good faith effort to meet this goal of DBE participation in the performance of the work. A bidder makes a good faith effort for award consideration if either of the following is done in accordance with the procedures set for in this Special Provision:

(a) The bidder documents that enough DBE participation has been obtained to meet the goal or,

(b) The bidder documents that a good faith effort has been made to meet the goal, even though the effort did not succeed in obtaining enough DBE participation to meet the goal.

DBE LOCATOR REFERENCES. Bidders shall consult the IL UCP DBE Directory as a reference source for DBE-certified companies. In addition, the Department maintains a letting and item specific DBE locator information system whereby DBE companies can register their interest in providing quotes on particular bid items advertised for letting. Information concerning DBE companies willing to quote work for particular contracts may be obtained by contacting the Department's Bureau of Small Business Enterprises at telephone number (217) 785-4611, or by visiting the Department's website at:

<http://www.idot.illinois.gov/doing-business/certifications/disadvantaged-business-enterprise-certification/il-ucp-directory/index>.

BIDDING PROCEDURES. Compliance with this Special Provision is required prior to the award of the contract and the failure of the low bidder to comply will render the bid not responsive.

In order to assure the timely award of the contract, the low bidder shall submit:

(a) The bidder shall submit a Disadvantaged Business Utilization Plan on completed Department forms SBE 2025 and 2026.

- (1) The final Utilization Plan must be submitted within five calendar days after the date of the letting.
- (2) To meet the five day requirement, the bidder may send the Utilization Plan electronically by scanning and sending to [DOT.DBE.UP@illinois.gov](mailto:DOT.DBE.UP@illinois.gov) or faxing to (217) 785-1524. The subject line must include the bid Item Number and the Letting date. The Utilization Plan should be sent as one .pdf file, rather than multiple files and emails for the same Item Number. It is the responsibility of the bidder to obtain confirmation of email or fax delivery.

Alternatively, the Utilization Plan may be sent by certified mail or delivery service within the five calendar day period. If a question arises concerning the mailing date of a Utilization Plan, the mailing date will be established by the U.S. Postal Service postmark on the original certified mail receipt from the U.S. Postal Service or the receipt issued by a delivery service. It is the responsibility of the bidder to ensure the postmark or receipt date is affixed within the five days if the bidder intends to rely upon mailing or delivery to satisfy the submission day requirement. The Utilization Plan is to be submitted to:

Illinois Department of Transportation  
Bureau of Small Business Enterprises  
Contract Compliance Section  
2300 South Dirksen Parkway, Room 319  
Springfield, Illinois 62764

The Department will not accept a Utilization Plan if it does not meet the five day submittal requirement and the bid will be declared not responsive. In the event the bid is declared not responsive due to a failure to submit a Utilization Plan or failure to comply with the bidding procedures set forth herein, the Department may elect to cause the forfeiture of the penal sum of the bidder's proposal guaranty, and may deny authorization to bid the project if re-advertised for bids. The Department reserves the right to invite any other bidder to submit a Utilization Plan at any time for award consideration or to extend the time for award.

- (b) The Utilization Plan shall indicate that the bidder either has obtained sufficient DBE participation commitments to meet the contract goal or has not obtained enough DBE participation commitments in spite of a good faith effort to meet the goal. The Utilization Plan shall further provide the name, telephone number, and telefax number of a responsible official of the bidder designated for purposes of notification of Utilization Plan approval or disapproval under the procedures of this Special Provision.
- (c) The Utilization Plan shall include a DBE Participation Commitment Statement, Department form SBE 2025, for each DBE proposed for the performance of work to achieve the contract goal. For bidding purposes, submission of the completed SBE 2025 forms, signed by the DBEs and scanned or faxed to the bidder will be acceptable as long as the original is available and provided upon request. All elements of information indicated on the said form shall be provided, including but not limited to the following:

- (1) The names and addresses of DBE firms that will participate in the contract;

- (2) A description, including pay item numbers, of the work each DBE will perform;
- (3) The dollar amount of the participation of each DBE firm participating. The dollar amount of participation for identified work shall specifically state the quantity, unit price, and total subcontract price for the work to be completed by the DBE. If partial pay items are to be performed by the DBE, indicate the portion of each item, a unit price where appropriate and the subcontract price amount;
- (4) DBE Participation Commitment Statements, form SBE 2025, signed by the bidder and each participating DBE firm documenting the commitment to use the DBE subcontractors whose participation is submitted to meet the contract goal;
- (5) If the bidder is a joint venture comprised of DBE companies and non-DBE companies, the Utilization Plan must also include a clear identification of the portion of the work to be performed by the DBE partner(s); and,
- (6) If the contract goal is not met, evidence of good faith efforts; the documentation of good faith efforts must include copies of each DBE and non-DBE subcontractor quote submitted to the bidder when a non-DBE subcontractor is selected over a DBE for work on the contract.

GOOD FAITH EFFORT PROCEDURES. The contract will not be awarded until the Utilization Plan submitted by the apparent successful bidder is approved. All information submitted by the bidder must be complete, accurate and adequately document that enough DBE participation has been obtained or document that good faith efforts of the bidder, in the event enough DBE participation has not been obtained, before the Department will commit to the performance of the contract by the bidder. The Utilization Plan will be approved by the Department if the Utilization Plan documents sufficient commercially useful DBE work to meet the contract goal or the bidder submits sufficient documentation of a good faith effort to meet the contract goal pursuant to 49 CFR Part 26, Appendix A. The Utilization Plan will not be approved by the Department if the Utilization Plan does not document sufficient DBE participation to meet the contract goal unless the apparent successful bidder documented in the Utilization Plan that it made a good faith effort to meet the goal. This means that the bidder must show that all necessary and reasonable steps were taken to achieve the contract goal. Necessary and reasonable steps are those which, by their scope, intensity and appropriateness to the objective, could reasonably be expected to obtain sufficient DBE participation, even if they were not successful. The Department will consider the quality, quantity, and intensity of the kinds of efforts that the bidder has made. Mere *pro forma* efforts, in other words, efforts done as a matter of form, are not good faith efforts; rather, the bidder is expected to have taken genuine efforts that would be reasonably expected of a bidder actively and aggressively trying to obtain DBE participation sufficient to meet the contract goal.

- (a) The following is a list of types of action that the Department will consider as part of the evaluation of the bidder's good faith efforts to obtain participation. These listed factors are not intended to be a mandatory checklist and are not intended to be exhaustive. Other factors or efforts brought to the attention of the Department may be relevant in appropriate cases, and will be considered by the Department.
  - (1) Soliciting through all reasonable and available means (e.g. attendance at pre-bid meetings, advertising and/or written notices) the interest of all certified DBE companies that have the capability to perform the work of the contract.

The bidder must solicit this interest within sufficient time to allow the DBE companies to respond to the solicitation. The bidder must determine with certainty if the DBE companies are interested by taking appropriate steps to follow up initial solicitations.

- (2) Selecting portions of the work to be performed by DBE companies in order to increase the likelihood that the DBE goals will be achieved. This includes, where appropriate, breaking out contract work items into economically feasible units to facilitate DBE participation, even when the prime Contractor might otherwise prefer to perform these work items with its own forces.
- (3) Providing interested DBE companies with adequate information about the plans, specifications, and requirements of the contract in a timely manner to assist them in responding to a solicitation.
- (4) a. Negotiating in good faith with interested DBE companies. It is the bidder's responsibility to make a portion of the work available to DBE subcontractors and suppliers and to select those portions of the work or material needs consistent with the available DBE subcontractors and suppliers, so as to facilitate DBE participation. Evidence of such negotiation includes the names, addresses, and telephone numbers of DBE companies that were considered; a description of the information provided regarding the plans and specifications for the work selected for subcontracting; and evidence as to why additional agreements could not be reached for DBE companies to perform the work.
  - b. A bidder using good business judgment would consider a number of factors in negotiating with subcontractors, including DBE subcontractors, and would take a firm's price and capabilities as well as contract goals into consideration. However, the fact that there may be some additional costs involved in finding and using DBE companies is not in itself sufficient reason for a bidder's failure to meet the contract DBE goal, as long as such costs are reasonable. Also the ability or desire of a bidder to perform the work of a contract with its own organization does not relieve the bidder of the responsibility to make good faith efforts. Bidders are not, however, required to accept higher quotes from DBE companies if the price difference is excessive or unreasonable. In accordance with subsection (c)(6) of the above Bidding Procedures, the documentation of good faith efforts must include copies of each DBE and non-DBE subcontractor quote submitted to the bidder when a non-DBE subcontractor was selected over a DBE for work on the contract.
- (5) Not rejecting DBE companies as being unqualified without sound reasons based on a thorough investigation of their capabilities. The bidder's standing within its industry, membership in specific groups, organizations, or associations and political or social affiliations (for example union vs. non-union employee status) are not legitimate causes for the rejection or non-solicitation of bids in the bidder's efforts to meet the project goal.
- (6) Making efforts to assist interested DBE companies in obtaining bonding, lines of credit, or insurance as required by the recipient or Contractor.
- (7) Making efforts to assist interested DBE companies in obtaining necessary equipment, supplies, materials, or related assistance or services.

- (8) Effectively using the services of available minority/women community organizations; minority/women contractors' groups; local, state, and federal minority/women business assistance offices; and other organizations as allowed on a case-by-case basis to provide assistance in the recruitment and placement of DBE companies.
- (b) If the Department determines that the apparent successful bidder has made a good faith effort to secure the work commitment of DBE companies to meet the contract goal, the Department will award the contract provided that it is otherwise eligible for award. If the Department determines that the bidder has failed to meet the requirements of this Special Provision or that a good faith effort has not been made, the Department will notify the responsible company official designated in the Utilization Plan that the bid is not responsive. The notification shall include a statement of reasons for the determination. If the Utilization Plan is not approved because it is deficient as a technical matter, unless waived by the Department, the bidder will be notified and will be allowed no more than a five calendar day period in order to cure the deficiency.
- (c) The bidder may request administrative reconsideration of a determination adverse to the bidder within the five working days after the receipt of the notification date of the determination by delivering the request to the Department of Transportation, Bureau of Small Business Enterprises, Contract Compliance Section, 2300 South Dirksen Parkway, Room 319, Springfield, Illinois 62764 (Telefax: (217) 785-1524). Deposit of the request in the United States mail on or before the fifth business day shall not be deemed delivery. The determination shall become final if a request is not made and delivered. A request may provide additional written documentation or argument concerning the issues raised in the determination statement of reasons, provided the documentation and arguments address efforts made prior to submitting the bid. The request will be forwarded to the Department's Reconsideration Officer. The Reconsideration Officer will extend an opportunity to the bidder to meet in person in order to consider all issues of documentation and whether the bidder made a good faith effort to meet the goal. After the review by the Reconsideration Officer, the bidder will be sent a written decision within ten working days after receipt of the request for consideration, explaining the basis for finding that the bidder did or did not meet the goal or make adequate good faith efforts to do so. A final decision by the Reconsideration Officer that a good faith effort was made shall approve the Utilization Plan submitted by the bidder and shall clear the contract for award. A final decision that a good faith effort was not made shall render the bid not responsive.

CALCULATING DBE PARTICIPATION. The Utilization Plan values represent work anticipated to be performed and paid for upon satisfactory completion. The Department is only able to count toward the achievement of the overall goal and the contract goal the value of payments made for the work actually performed by DBE companies. In addition, a DBE must perform a commercially useful function on the contract to be counted. A commercially useful function is generally performed when the DBE is responsible for the work and is carrying out its responsibilities by actually performing, managing, and supervising the work involved. The Department and Contractor are governed by the provisions of 49 CFR Part 26.55(c) on questions of commercially useful functions as it affects the work. Specific counting guidelines are provided in 49 CFR Part 26.55, the provisions of which govern over the summary contained herein.

- (a) DBE as the Contractor: 100 percent goal credit for that portion of the work performed by the DBE's own forces, including the cost of materials and supplies. Work that a DBE subcontracts to a non-DBE does not count toward the DBE goals.
- (b) DBE as a joint venture Contractor: 100 percent goal credit for that portion of the total dollar value of the contract equal to the distinct, clearly defined portion of the work performed by the DBE's own forces.
- (c) DBE as a subcontractor: 100 percent goal credit for the work of the subcontract performed by the DBE's own forces, including the cost of materials and supplies, excluding the purchase of materials and supplies or the lease of equipment by the DBE subcontractor from the prime Contractor or its affiliates. Work that a DBE subcontractor in turn subcontracts to a non-DBE does not count toward the DBE goal.
- (d) DBE as a trucker: 100 percent goal credit for trucking participation provided the DBE is responsible for the management and supervision of the entire trucking operation for which it is responsible. At least one truck owned, operated, licensed, and insured by the DBE must be used on the contract. Credit will be given for the following:
  - (1) The DBE may lease trucks from another DBE firm, including an owner-operator who is certified as a DBE. The DBE who leases trucks from another DBE receives credit for the total value of the transportation services the lessee DBE provides on the contract.
  - (2) The DBE may also lease trucks from a non-DBE firm, including from an owner-operator. The DBE who leases trucks from a non-DBE is entitled to credit only for the fee or commission is receives as a result of the lease arrangement.
- (e) DBE as a material supplier:
  - (1) 60 percent goal credit for the cost of the materials or supplies purchased from a DBE regular dealer.
  - (2) 100 percent goal credit for the cost of materials of supplies obtained from a DBE manufacturer.
  - (3) 100 percent credit for the value of reasonable fees and commissions for the procurement of materials and supplies if not a DBE regular dealer or DBE manufacturer.

CONTRACT COMPLIANCE. Compliance with this Special Provision is an essential part of the contract. The Department is prohibited by federal regulations from crediting the participation of a DBE included in the Utilization Plan toward either the contract goal or the Department's overall goal until the amount to be applied toward the goals has been paid to the DBE. The following administrative procedures and remedies govern the compliance by the Contractor with the contractual obligations established by the Utilization Plan. After approval of the Utilization Plan and award of the contract, the Utilization Plan and individual DBE Participation Statements become part of the contract. If the Contractor did not succeed in obtaining enough DBE participation to achieve the advertised contract goal, and the Utilization Plan was approved and contract awarded based upon a determination of good faith, the total dollar value of DBE work calculated in the approved Utilization Plan as a percentage of the awarded contract value shall become the amended contract goal. All work indicated for performance by an approved DBE shall be performed, managed, and supervised by the DBE executing the DBE Participation Commitment Statement.

- (a) NO AMENDMENT. No amendment to the Utilization Plan may be made without prior written approval from the Department's Bureau of Small Business Enterprises. All requests for amendment to the Utilization Plan shall be submitted to the Department of Transportation, Bureau of Small Business Enterprises, Contract Compliance Section, 2300 South Dirksen Parkway, Room 319, Springfield, Illinois 62764. Telephone number (217) 785-4611. Telefax number (217) 785-1524.
- (b) CHANGES TO WORK. Any deviation from the DBE condition-of-award or contract plans, specifications, or special provisions must be approved, in writing, by the Department as provided elsewhere in the Contract. The Contractor shall notify affected DBEs in writing of any changes in the scope of work which result in a reduction in the dollar amount condition-of-award to the contract. Where the revision includes work committed to a new DBE subcontractor, not previously involved in the project, then a Request for Approval of Subcontractor, Department form BC 260A or AER 260A, must be signed and submitted. If the commitment of work is in the form of additional tasks assigned to an existing subcontract, then a new Request for Approval of Subcontractor shall not be required. However, the Contractor must document efforts to assure that the existing DBE subcontractor is capable of performing the additional work and has agreed in writing to the change.
- (c) SUBCONTRACT. The Contractor must provide DBE subcontracts to IDOT upon request. Subcontractors shall ensure that all lower tier subcontracts or agreements with DBEs to supply labor or materials be performed in accordance with this Special Provision.
- (d) ALTERNATIVE WORK METHODS. In addition to the above requirements for reductions in the condition of award, additional requirements apply to the two cases of Contractor-initiated work substitution proposals. Where the contract allows alternate work methods which serve to delete or create underruns in condition of award DBE work, and the Contractor selects that alternate method or, where the Contractor proposes a substitute work method or material that serves to diminish or delete work committed to a DBE and replace it with other work, then the Contractor must demonstrate one of the following:
- (1) That the replacement work will be performed by the same DBE (as long as the DBE is certified in the respective item of work) in a modification of the condition of award;  
or
  - (2) That the DBE is aware that its work will be deleted or will experience underruns and has agreed in writing to the change. If this occurs, the Contractor shall substitute other work of equivalent value to a certified DBE or provide documentation of good faith efforts to do so; or
  - (3) That the DBE is not capable of performing the replacement work or has declined to perform the work at a reasonable competitive price. If this occurs, the Contractor shall substitute other work of equivalent value to a certified DBE or provide documentation of good faith efforts to do so.
- (e) TERMINATION AND REPLACEMENT PROCEDURES. The Contractor shall not terminate or replace a DBE listed on the approved Utilization Plan, or perform with other forces work designated for a listed DBE except as provided in this Special Provision. The Contractor shall utilize the specific DBEs listed to perform the work and supply the materials for which each is listed unless the Contractor obtains the Department's written consent as provided in subsection (a) of this part.



Unless Department consent is provided for termination of a DBE subcontractor, the Contractor shall not be entitled to any payment for work or material unless it is performed or supplied by the DBE in the Utilization Plan.

As stated above, the Contractor shall not terminate or replace a DBE subcontractor listed in the approved Utilization Plan without prior written consent. This includes, but is not limited to, instances in which the Contractor seeks to perform work originally designated for a DBE subcontractor with its own forces or those of an affiliate, a non-DBE firm, or with another DBE firm. Written consent will be granted only if the Bureau of Small Business Enterprises agrees, for reasons stated in its concurrence document, that the Contractor has good cause to terminate or replace the DBE firm. Before transmitting to the Bureau of Small Business Enterprises any request to terminate and/or substitute a DBE subcontractor, the Contractor shall give notice in writing to the DBE subcontractor, with a copy to the Bureau, of its intent to request to terminate and/or substitute, and the reason for the request. The Contractor shall give the DBE five days to respond to the Contractor's notice. The DBE so notified shall advise the Bureau and the Contractor of the reasons, if any, why it objects to the proposed termination of its subcontract and why the Bureau should not approve the Contractor's action. If required in a particular case as a matter of public necessity, the Bureau may provide a response period shorter than five days.

For purposes of this paragraph, good cause includes the following circumstances:

- (1) The listed DBE subcontractor fails or refuses to execute a written contract;
- (2) The listed DBE subcontractor fails or refuses to perform the work of its subcontract in a way consistent with normal industry standards. Provided, however, that good cause does not exist if the failure or refusal of the DBE subcontractor to perform its work on the subcontract results from the bad faith or discriminatory action of the prime contractor;
- (3) The listed DBE subcontractor fails or refuses to meet the prime Contractor's reasonable, nondiscriminatory bond requirements;
- (4) The listed DBE subcontractor becomes bankrupt, insolvent, or exhibits credit unworthiness;
- (5) The listed DBE subcontractor is ineligible to work on public works projects because of suspension and debarment proceedings pursuant 2 CFR Parts 180, 215 and 1200 or applicable state law.
- (6) You have determined that the listed DBE subcontractor is not a responsible contractor;
- (7) The listed DBE subcontractor voluntarily withdraws from the projects and provides to you written notice of its withdrawal;
- (8) The listed DBE is ineligible to receive DBE credit for the type of work required;
- (9) A DBE owner dies or becomes disabled with the result that the listed DBE contractor is unable to complete its work on the contract;

- (10) Other documented good cause that compels the termination of the DBE subcontractor. Provided, that good cause does not exist if the prime Contractor seeks to terminate a DBE it relied upon to obtain the contract so that the prime Contractor can self-perform the work for which the DBE contractor was engaged or so that the prime Contractor can substitute another DBE or non-DBE contractor after contract award.

When a DBE is terminated, or fails to complete its work on the Contract for any reason the Contractor shall make a good faith effort to find another DBE to substitute for the original DBE to perform at least the same amount of work under the contract as the terminated DBE to the extent needed to meet the established Contract goal. The good faith efforts shall be documented by the Contractor. If the Department requests documentation under this provision, the Contractor shall submit the documentation within seven days, which may be extended for an additional seven days if necessary at the request of the Contractor. The Department shall provide a written determination to the Contractor stating whether or not good faith efforts have been demonstrated.

- (f) PAYMENT RECORDS. The Contractor shall maintain a record of payments for work performed to the DBE participants. The records shall be made available to the Department for inspection upon request. After the performance of the final item of work or delivery of material by a DBE and final payment therefore to the DBE by the Contractor, but not later than thirty calendar days after payment has been made by the Department to the Contractor for such work or material, the Contractor shall submit a DBE Payment Agreement on Department form SBE 2115 to the Resident Engineer. If full and final payment has not been made to the DBE, the DBE Payment Agreement shall indicate whether a disagreement as to the payment required exists between the Contractor and the DBE or if the Contractor believes that the work has not been satisfactorily completed. If the Contractor does not have the full amount of work indicated in the Utilization Plan performed by the DBE companies indicated in the Utilization Plan and after good faith efforts are reviewed, the Department may deduct from contract payments to the Contractor the amount of the goal not achieved as liquidated and ascertained damages. The Contractor may request an administrative reconsideration of any amount deducted as damages pursuant to subsection (h) of this part.
- (g) ENFORCEMENT. The Department reserves the right to withhold payment to the Contractor to enforce the provisions of this Special Provision. Final payment shall not be made on the contract until such time as the Contractor submits sufficient documentation demonstrating achievement of the goal in accordance with this Special Provision or after liquidated damages have been determined and collected.
- (h) RECONSIDERATION. Notwithstanding any other provision of the contract, including but not limited to Article 109.09 of the Standard Specifications, the Contractor may request administrative reconsideration of a decision to deduct the amount of the goal not achieved as liquidated damages. A request to reconsider shall be delivered to the Contract Compliance Section and shall be handled and considered in the same manner as set forth in paragraph (c) of "Good Faith Effort Procedures" of this Special Provision, except a final decision that a good faith effort was not made during contract performance to achieve the goal agreed to in the Utilization Plan shall be the final administrative decision of the Department.

The result of the reconsideration process is not administratively appealable to the U.S. Department of Transportation.

### **EQUAL EMPLOYMENT OPPORTUNITY (BDE)**

Effective: April 1, 2015

FEDERAL AID CONTRACTS. Revise the following section of Check Sheet #1 of the Recurring Special Provisions to read:

#### "EQUAL EMPLOYMENT OPPORTUNITY

In the event of the Contractor's noncompliance with the provisions of this Equal Employment Opportunity Clause, the Illinois Human Rights Act, or the Illinois Department of Human Rights Rules and Regulations, the Contractor may be declared ineligible for future contracts or subcontracts with the State of Illinois or any of its political sub-divisions or municipal corporations, and the contract may be cancelled or voided in whole or in part, and such other sanctions or penalties may be imposed or remedies invoked as provided by statute or regulation.

During the performance of this Contract, the Contractor agrees as follows:

- (1) That it will not discriminate against any employee or applicant for employment because of race, color, religion, sex, sexual orientation, marital status, order of protection status, national origin or ancestry, citizenship status, age, physical or mental disability unrelated to ability, military status, or an unfavorable discharge from military service; and further that it will examine all job classifications to determine if minority persons or women are underutilized and will take appropriate affirmative action to rectify any such underutilization.
- (2) That, if it hires additional employees in order to perform this contract or any portion hereof, it will determine the availability (according to the Illinois Department of Human Rights Rules and Regulations) of minorities and women in the area(s) from which it may reasonably recruit and it will hire for each job classification for which employees are hired in such a way that minorities and women are not underutilized.
- (3) That, in all solicitations or advertisements for employees placed by it or on its behalf, it will state that all applicants will be afforded equal opportunity without discrimination because of race, color, religion, sex, sexual orientation, marital status, order of protection status, national origin or ancestry, citizenship status, age, physical or mental disability unrelated to ability, military status or an unfavorable discharge from military service.
- (4) That it will send to each labor organization or representative of workers with which it has or is bound by a collective bargaining or other agreement or understanding, a notice advising such labor organization or representative of the Contractor's obligations under the Illinois Human Rights Act and the Illinois Department of Human Rights Rules and Regulations. If any labor organization or representative fails or refuses to cooperate with the Contractor in its efforts to comply with such Act and Rules and Regulations, the

Contractor will promptly so notify the Illinois Department of Human Rights and IDOT and will recruit employees from other sources when necessary to fulfill its obligations thereunder.

- (5) That it will submit reports as required by the Illinois Department of Human Rights Rules and Regulations, furnish all relevant information as may from time to time be requested by the Illinois Department of Human Rights or IDOT, and in all respects comply with the Illinois Human Rights Act and the Illinois Department of Human Rights Rules and Regulations.
- (6) That it will permit access to all relevant books, records, accounts, and work sites by personnel of IDOT and the Illinois Department of Human Rights for purposes of investigation to ascertain compliance with the Illinois Human Rights Act and the Illinois Department of Human Rights Rules and Regulations.
- (7) That it will include verbatim or by reference the provisions of this clause in every subcontract it awards under which any portion of the contract obligations are undertaken or assumed, so that the provisions will be binding upon the subcontractor. In the same manner as with other provisions of this contract, the Contractor will be liable for compliance with applicable provisions of this clause by subcontractors; and further it will promptly notify IDOT and the Illinois Department of Human Rights in the event any subcontractor fails or refuses to comply with these provisions. In addition, the Contractor will not utilize any subcontractor declared by the Illinois Human Rights Commission to be ineligible for contracts or subcontracts with the State of Illinois or any of its political subdivisions or municipal corporations."

STATE CONTRACTS. Revise Section II of Check Sheet #5 of the Recurring Special Provisions to read:

#### "II. EQUAL EMPLOYMENT OPPORTUNITY

In the event of the Contractor's noncompliance with the provisions of this Equal Employment Opportunity Clause, the Illinois Human Rights Act or the Illinois Department of Human Rights Rules and Regulations, the Contractor may be declared ineligible for future contracts or subcontracts with the State of Illinois or any of its political sub-divisions or municipal corporations, and the contract may be cancelled or voided in whole or in part, and such other sanctions or penalties may be imposed or remedies invoked as provided by statute or regulation.

During the performance of this Contract, the Contractor agrees as follows:

1. That it will not discriminate against any employee or applicant for employment because of race, color, religion, sex, sexual orientation, marital status, order of protection status, national origin or ancestry, citizenship status, age, physical or mental disability unrelated to ability, military status, or an unfavorable discharge from military service; and further that it will examine all job classifications to determine if minority persons or women are underutilized and will take appropriate affirmative action to rectify any such underutilization.

2. That, if it hires additional employees in order to perform this contract or any portion hereof, it will determine the availability (according to the Illinois Department of Human Rights Rules and Regulations) of minorities and women in the area(s) from which it may reasonably recruit and it will hire for each job classification for which employees are hired in such a way that minorities and women are not underutilized.
3. That, in all solicitations or advertisements for employees placed by it or on its behalf, it will state that all applicants will be afforded equal opportunity without discrimination because of race, color, religion, sex, sexual orientation, marital status, order of protection status, national origin or ancestry, citizenship status, age, physical or mental disability unrelated to ability, military status, or an unfavorable discharge from military service.
4. That it will send to each labor organization or representative of workers with which it has or is bound by a collective bargaining or other agreement or understanding, a notice advising such labor organization or representative of the Contractor's obligations under the Illinois Human Rights Act and the Illinois Department of Human Rights Rules and Regulations. If any labor organization or representative fails or refuses to cooperate with the Contractor in its efforts to comply with such Act and Rules and Regulations, the Contractor will promptly so notify the Illinois Department of Human Rights and IDOT and will recruit employees from other sources when necessary to fulfill its obligations thereunder.
5. That it will submit reports as required by the Illinois Department of Human Rights Rules and Regulations, furnish all relevant information as may from time to time be requested by the Illinois Department of Human Rights or IDOT, and in all respects comply with the Illinois Human Rights Act and the Illinois Department of Human Rights Rules and Regulations.
6. That it will permit access to all relevant books, records, accounts and work sites by personnel of IDOT and the Illinois Department of Human Rights for purposes of investigation to ascertain compliance with the Illinois Human Rights Act and the Illinois Department of Human Rights Rules and Regulations.
7. That it will include verbatim or by reference the provisions of this clause in every subcontract it awards under which any portion of the contract obligations are undertaken or assumed, so that the provisions will be binding upon the subcontractor. In the same manner as with other provisions of this contract, the Contractor will be liable for compliance with applicable provisions of this clause by subcontractors; and further it will promptly notify IDOT and the Illinois Department of Human Rights in the event any subcontractor fails or refuses to comply with these provisions. In addition, the Contractor will not utilize any subcontractor declared by the Illinois Human Rights Commission to be ineligible for contracts or subcontracts with the State of Illinois or any of its political subdivisions or municipal corporations."

**ERRATA FOR THE 2016 STANDARD SPECIFICATIONS (BDE)**

Effective: April 1, 2016

Page 84 Article 204.02. In the seventh line of the first paragraph change "AASHTO T 99 (Method C)" to "Illinois Modified AASHTO T 99 (Method C)".

- Page 90 Article 205.06. In the first sentence of the third paragraph change “AASHTO T 99 (Method C)” to “Illinois Modified AASHTO T 99 (Method C)”.
- Page 91 Article 205.06. In the first sentence of the fourth paragraph change “AASHTO T 99 (Method C)” to “Illinois Modified AASHTO T 99 (Method C)”, and in the second sentence change “AASHTO T 224” to “Illinois Modified AASHTO T 99 (Annex A1)”.
- Page 91 Article 205.06. In the second line of the fifth paragraph change “AASHTO T 191” to “Illinois Modified AASHTO T 191”.
- Page 91 Article 205.06. In the sixth line of the eighth paragraph change “AASHTO T 99 (Method C)” to “Illinois Modified AASHTO T 99 (Method C)”.
- Page 148 Article 302.09. In the second sentence of the fifth paragraph change “AASHTO T 191” to “Illinois Modified AASHTO T 191”, and in the third sentence change “AASHTO T 99” to “Illinois Modified AASHTO T 99”.
- Page 152 Article 310.09. In the second sentence of the second paragraph change “AASHTO T 191” to “Illinois Modified AASHTO T 191”, and in the third sentence change “AASHTO T 99” to “Illinois Modified AASHTO T 99”.
- Page 155 Article 311.05(a). In the first sentence of the fifth paragraph change “AASHTO T 99 (Method C)” to “Illinois Modified AASHTO T 99 (Method C)”, and in the second sentence change “AASHTO T 224” to “Illinois Modified AASHTO T 99 (Annex A1)”.
- Page 155 Article 311.05(a). In the second line of the sixth paragraph change “AASHTO T 191” to “Illinois Modified AASHTO T 191”.
- Page 163 Article 351.05(a). In the second sentence of the fifth paragraph change “AASHTO T 99 (Method C)” to “Illinois Modified AASHTO T 99 (Method C)”, and in the third sentence change “AASHTO T 224” to “Illinois Modified AASHTO T 99 (Annex A1)”.
- Page 163 Article 351.05(a). In the second line of the sixth paragraph change “AASHTO T 191” to “Illinois Modified AASHTO T 191”.
- Page 169 Article 352.11. In the second sentence of the fourth paragraph change “AASHTO T 191” to “Illinois Modified AASHTO T 191”, and in the third sentence change “AASHTO T 134 (Method B)” to “Illinois Modified AASHTO T 134 (Method B)”.
- Page 169 Article 352.12. In the first sentence of the first paragraph change “AASHTO T 22” to “Illinois Modified AASHTO T 22”, and in the second sentence change “AASHTO T 134 (Method B)” to “Illinois Modified AASHTO T 134 (Method B)”.
- Page 196 Article 406.07(a). After the footnotes in Table 1 - Minimum Roller Requirements for HMA add the following:

“EQUIPMENT DEFINITION

- V<sub>s</sub> - Vibratory roller, static mode, minimum 125 lb/in. (2.2 kg/mm) of roller width. Maximum speed = 3 mph (5 km/h) or 264 ft/min (80 m/min). If the vibratory roller does not eliminate roller marks, its use shall be discontinued and a tandem roller, adequately ballasted to remove roller marks, shall be used.
- V<sub>D</sub> - Vibratory roller, dynamic mode, operated at a speed to produce not less than 10 impacts/ft (30 impacts/m).
- P - Pneumatic-tired roller, max. speed 3 1/2 mph (5.5 km/h) or 308 ft/min (92 m/min). The pneumatic-tired roller shall have a minimum tire pressure of 80 psi (550 kPa) and shall be equipped with heat retention shields. The self-propelled pneumatic-tired roller shall develop a compression of not less than 300 lb (53 N) nor more than 500 lb (88 N) per in. (mm) of width of the tire tread in contact with the HMA surface.
- T<sub>B</sub> - Tandem roller for breakdown rolling, 8 to 12 tons (7 to 11 metric tons), 250 to 400 lb/in. (44 to 70 N/mm) of roller width, max. speed = 3 1/2 mph (5.5 km/h) or 308 ft/min (92 m/min).
- T<sub>F</sub> - Tandem roller for final rolling, 200 to 400 lb/in. (35 to 70 N/mm) of roller width with minimum roller width of 50 in. (1.25 m). Ballast shall be increased if roller marks are not eliminated. Ballast shall be decreased if the mat shoves or distorts.
- 3W- Three wheel roller, max. speed = 3 mph (5 km/h) or 264 ft/min (80 m/min), 300 to 400 lb/in. (53 to 70 N/mm) of roller width. The three-wheel roller shall weigh 10 to 12 tons (9 to 11 metric tons)."

- Page 331 Article 505.04(p). Under Range of Clearance in the first table change "in. x 10<sup>-6</sup>" to "in. x 10<sup>-3</sup>".
- Page 444 Article 542.03. In the Notes in Table IIIB add "CPP Corrugated Polypropylene (CPP) pipe with smooth interior".
- Page 445 Article 542.03. In the fourth column in Table IIIB (metric) change the heading for Type 5 pipe from "CPE" to "CPP".
- Page 445 Article 542.03. In the Notes in Table IIIB (metric) change "PE Polyethylene (PE) pipe with a smooth interior" to "CPP Corrugated Polypropylene (CPP) pipe with smooth interior".
- Page 449 Article 542.04(f)(2). In the third line of the second paragraph change "AASHTO T 99 (Method C)" to "Illinois Modified AASHTO T 99 (Method C)".
- Page 544 Article 639.03. In the first sentence of the first paragraph change "AASHTO Standard Specifications for Structural Supports for Highway Signs, Luminaires, Traffic Signals," to "AASHTO "LRFD Specifications for Structural Supports for Highway Signs, Luminaires, and Traffic Signals,"".

- Page 546 Article 640.03. In the first sentence of the first paragraph change “AASHTO Standard Specifications for Structural Supports for Highway Signs, Luminaires, and Traffic Signals” to “AASHTO “LRFD Specifications for Structural Supports for Highway Signs, Luminaires, and Traffic Signals””.
- Page 548 Article 641.03. In the first sentence of the first paragraph change “AASHTO Standard Specifications for Structural Supports for Highway Signs, Luminaire and Traffic Signals,” to “AASHTO “LRFD Specifications for Structural Supports for Highway Signs, Luminaires, and Traffic Signals,””.
- Page 621 Article 727.03. In the first sentence of the third paragraph change “AASHTO Standard Specifications for Structural Supports for Highway Signs, Luminaires and Traffic Signals” to “AASHTO “LRFD Specifications for Structural Supports for Highway Signs, Luminaires, and Traffic Signals””.
- Page 629 Article 734.03(a). In the fourth line of the second paragraph change “AASHTO T 99 (Method C)” to “Illinois Modified AASHTO T 99 (Method C)”.
- Page 649 Article 801.02. In the first sentence of the first paragraph change “AASHTO’s Standard Specifications for Structural Supports for Highway Signs, Luminaires, and Traffic Signals” to “AASHTO “LRFD Specifications for Structural Supports for Highway Signs, Luminaires, and Traffic Signals””.
- Page 742 Article 1003.04(c). Under Gradation in the table change “(see Article 1003.02(c))” to “(see Article 1003.01(c))”.
- Page 755 Article 1004.03(b). Revise the third sentence of the first paragraph to read “For Class A (seal or cover coat), and other binder courses, the coarse aggregate shall be Class C quality or better.”.
- Page 809 Article 1020.04(e). In the third line of the first paragraph change “ITP SCC-3” to “ITP SCC-4”.
- Page 945 Article 1069.05. In the first sentence of the tenth paragraph change ““Standard Specifications for Structural Supports for Highway Signs, Luminaires, and Traffic Signals”” to “AASHTO “LRFD Specifications for Structural Supports for Highway Signs, Luminaires, and Traffic Signals””.
- Page 961 Article 1070.04(b)(1). In the third sentence of the first paragraph change ““Standard Specifications of Structural Supports for Highway Signs, Luminaires and Traffic Signals” published by AASHTO” to “AASHTO “LRFD Specifications for Structural Supports for Highway Signs, Luminaires, and Traffic Signals””.
- Page 989 Article 1077.01. In the second sentence of the first paragraph change “Standard Specifications for Structural Supports for Highway Signs, Luminaires, and Traffic Signals, as published by AASHTO” to “AASHTO “LRFD Specifications for Structural Supports for Highway Signs, Luminaires, and Traffic Signals””.
- Page 1121 Article 1103.13(a). In the first line of the first paragraph change “Bridge Deck Approach Slabs.” to “Bridge Deck and Approach Slabs.”.



**PROGRESS PAYMENTS (BDE)**

Effective: November 2, 2013

Revise Article 109.07(a) of the Standard Specifications to read:

“(a) Progress Payments. At least once each month, the Engineer will make a written estimate of the quantity of work performed in accordance with the contract, and the value thereof at the contract unit prices. The amount of the estimate approved as due for payment will be vouchered by the Department and presented to the State Comptroller for payment. No amount less than \$1000.00 will be approved for payment other than the final payment.

Progress payments may be reduced by liens filed pursuant to Section 23(c) of the Mechanics’ Lien Act, 770 ILCS 60/23(c).

If a Contractor or subcontractor has defaulted on a loan issued under the Department’s Disadvantaged Business Revolving Loan Program (20 ILCS 2705/2705-610), progress payments may be reduced pursuant to the terms of that loan agreement. In such cases, the amount of the estimate related to the work performed by the Contractor or subcontractor, in default of the loan agreement, will be offset, in whole or in part, and vouchered by the Department to the Working Capital Revolving Fund or designated escrow account. Payment for the work shall be considered as issued and received by the Contractor or subcontractor on the date of the offset voucher. Further, the amount of the offset voucher shall be a credit against the Department’s obligation to pay the Contractor, the Contractor’s obligation to pay the subcontractor, and the Contractor’s or subcontractor’s total loan indebtedness to the Department. The offset shall continue until such time as the entire loan indebtedness is satisfied. The Department will notify the Contractor and Fund Control Agent in a timely manner of such offset. The Contractor or subcontractor shall not be entitled to additional payment in consideration of the offset.

The failure to perform any requirement, obligation, or term of the contract by the Contractor shall be reason for withholding any progress payments until the Department determines that compliance has been achieved.”

**RECLAIMED ASPHALT PAVEMENT AND RECLAIMED ASPHALT SHINGLES (BDE)**

Effective: November 1, 2012

Revise: April 1, 2016

Revise Section 1031 of the Standard Specifications to read:

**“SECTION 1031. RECLAIMED ASPHALT PAVEMENT AND RECLAIMED ASPHALT SHINGLES**

**1031.01 Description.** Reclaimed asphalt pavement and reclaimed asphalt shingles shall be according to the following.

(a) Reclaimed Asphalt Pavement (RAP). RAP is the material produced by cold milling or crushing an existing hot-mix asphalt (HMA) pavement. The Contractor shall supply written documentation that the RAP originated from routes or airfields under federal, state, or local agency jurisdiction.

(b) Reclaimed Asphalt Shingles (RAS). Reclaimed asphalt shingles (RAS). RAS is from the processing and grinding of preconsumer or post-consumer shingles. RAS shall be a clean and uniform material with a maximum of 0.5 percent unacceptable material, as defined in Bureau of Materials and Physical Research Policy Memorandum, "Reclaimed Asphalt Shingle (RAS) Sources", by weight of RAS. All RAS used shall come from a Bureau of Materials and Physical Research approved processing facility where it shall be ground and processed to 100 percent passing the 3/8 in. (9.5 mm) sieve and 93 percent passing the #4 (4.75 mm) sieve based on a dry shake gradation. RAS shall be uniform in gradation and asphalt binder content and shall meet the testing requirements specified herein. In addition, RAS shall meet the following Type 1 or Type 2 requirements.

(1) Type 1. Type 1 RAS shall be processed, preconsumer asphalt shingles salvaged from the manufacture of residential asphalt roofing shingles.

(2) Type 2. Type 2 RAS shall be processed post-consumer shingles only, salvaged from residential, or four unit or less dwellings not subject to the National Emission Standards for Hazardous Air Pollutants (NESHAP).

**1031.02 Stockpiles.** RAP and RAS stockpiles shall be according to the following.

(a) RAP Stockpiles. The Contractor shall construct individual, sealed RAP stockpiles meeting one of the following definitions. No additional RAP shall be added to the pile after the pile has been sealed. Stockpiles shall be sufficiently separated to prevent intermingling at the base. Stockpiles shall be identified by signs indicating the type as listed below (i.e. "Homogeneous Surface").

Prior to milling, the Contractor shall request the District provide documentation on the quality of the RAP to clarify the appropriate stockpile.

(1) Fractionated RAP (FRAP). FRAP shall consist of RAP from Class I, HMA (High and Low ESAL) mixtures. The coarse aggregate in FRAP shall be crushed aggregate and may represent more than one aggregate type and/or quality, but shall be at least C quality. All FRAP shall be fractionated prior to testing by screening into a minimum of two size fractions with the separation occurring on or between the #4 (4.75 mm) and 1/2 in. (12.5 mm) sieves. Agglomerations shall be minimized such that 100 percent of the RAP shall pass the sieve size specified below for the mix into which the FRAP will be incorporated.

Mixture FRAP will be used in:	Sieve Size that 100 % of FRAP Shall Pass
IL-19.0	1 1/2 in. (40 mm)
IL-9.5	3/4 in. (20 mm)
IL-4.75	1/2 in. (13 mm)

(2) Homogeneous. Homogeneous RAP stockpiles shall consist of RAP from Class I, HMA (High and Low ESAL) mixtures and represent: 1) the same aggregate quality, but shall be at least C quality; 2) the same type of crushed aggregate (either crushed natural aggregate, ACBF slag, or steel slag); 3) similar gradation; and 4) similar asphalt binder content.

If approved by the Engineer, combined single pass surface/binder millings may be considered "homogeneous" with a quality rating dictated by the lowest coarse aggregate quality present in the mixture.

- (3) Conglomerate. Conglomerate RAP stockpiles shall consist of RAP from Class I, HMA (High and Low ESAL) mixtures. The coarse aggregate in this RAP shall be crushed aggregate and may represent more than one aggregate type and/or quality, but shall be at least C quality. This RAP may have an inconsistent gradation and/or asphalt binder content prior to processing. All conglomerate RAP shall be processed prior to testing by crushing to where all RAP shall pass the 5/8 in. (16 mm) or smaller screen. Conglomerate RAP stockpiles shall not contain steel slag.
- (4) Non-Quality. RAP stockpiles that do not meet the requirements of the stockpile categories listed above shall be classified as "Non-Quality".

RAP/FRAP containing contaminants, such as earth, brick, sand, concrete, sheet asphalt, bituminous surface treatment (i.e. chip seal), pavement fabric, joint sealants, etc., will be unacceptable unless the contaminants are removed to the satisfaction of the Engineer. Sheet asphalt shall be stockpiled separately.

- (b) RAS Stockpiles. Type 1 and Type 2 RAS shall be stockpiled separately and shall not be intermingled. Each stockpile shall be signed indicating what type of RAS is present.

Unless otherwise specified by the Engineer, mechanically blending manufactured sand (FM 20 or FM 22) up to an equal weight of RAS with the processed RAS will be permitted to improve workability. The sand shall be "B Quality" or better from an approved Aggregate Gradation Control System source. The sand shall be accounted for in the mix design and during HMA production.

Records identifying the shingle processing facility supplying the RAS, RAS type, and lot number shall be maintained by project contract number and kept for a minimum of three years.

**1031.03 Testing.** RAP/FRAP and RAS testing shall be according to the following.

- (a) RAP/FRAP Testing. When used in HMA, the RAP/FRAP shall be sampled and tested either during or after stockpiling.
  - (1) During Stockpiling. For testing during stockpiling, washed extraction samples shall be run at the minimum frequency of one sample per 500 tons (450 metric tons) for the first 2000 tons (1800 metric tons) and one sample per 2000 tons (1800 metric tons) thereafter. A minimum of five tests shall be required for stockpiles less than 4000 tons (3600 metric tons).
  - (2) After Stockpiling. For testing after stockpiling, the Contractor shall submit a plan for approval to the District proposing a satisfactory method of sampling and testing the RAP/FRAP pile either in-situ or by restockpiling. The sampling plan shall meet the minimum frequency required above and detail the procedure used to obtain representative samples throughout the pile for testing.

Each sample shall be split to obtain two equal samples of test sample size. One of the two test samples from the final split shall be labeled and stored for Department use. The Contractor shall extract the other test sample according to Department procedure. The Engineer reserves the right to test any sample (split or Department-taken) to verify Contractor test results.

- (b) RAS Testing. RAS or RAS blended with manufactured sand shall be sampled and tested during stockpiling according to Bureau of Materials and Physical Research Policy Memorandum, "Reclaimed Asphalt Shingle (RAS) Source".

Samples shall be collected during stockpiling at the minimum frequency of one sample per 200 tons (180 metric tons) for the first 1000 tons (900 metric tons) and one sample per 250 tons (225 metric tons) thereafter. A minimum of five samples are required for stockpiles less than 1000 tons (900 metric tons). Once a  $\leq 1000$  ton (900 metric ton), five-sample/test stockpile has been established it shall be sealed. Additional incoming RAS or RAS blended with manufactured sand shall be stockpiled in a separate working pile as designated in the Quality Control plan and only added to the sealed stockpile when the test results of the working pile are complete and are found to meet the tolerances specified herein for the original sealed RAS stockpile.

Before testing, each sample shall be split to obtain two test samples. One of the two test samples from the final split shall be labeled and stored for Department use. The Contractor shall perform a washed extraction and test for unacceptable materials on the other test sample according to Department procedures. The Engineer reserves the right to test any sample (split or Department-taken) to verify Contractor test results.

If the sampling and testing was performed at the shingle processing facility in accordance with the QC Plan, the Contractor shall obtain and make available all of the test results from start of the initial stockpile.

**1031.04 Evaluation of Tests.** Evaluation of test results shall be according to the following.

- (a) Evaluation of RAP/FRAP Test Results. All of the extraction results shall be compiled and averaged for asphalt binder content and gradation, and when applicable  $G_{mm}$ . Individual extraction test results, when compared to the averages, will be accepted if within the tolerances listed below.

Parameter	FRAP/Homogeneous/ Conglomerate
1 in. (25 mm)	
1/2 in. (12.5 mm)	$\pm 8 \%$
No. 4 (4.75 mm)	$\pm 6 \%$
No. 8 (2.36 mm)	$\pm 5 \%$
No. 16 (1.18 mm)	
No. 30 (600 $\mu\text{m}$ )	$\pm 5 \%$
No. 200 (75 $\mu\text{m}$ )	$\pm 2.0 \%$
Asphalt Binder	$\pm 0.4 \%$ <sup>1/</sup>
$G_{mm}$	$\pm 0.03$

1/ The tolerance for FRAP shall be  $\pm 0.3 \%$ .

If more than 20 percent of the individual sieves and/or asphalt binder content tests are out of the above tolerances, the RAP/FRAP shall not be used in HMA unless the RAP/FRAP representing the failing tests is removed from the stockpile. All test data and acceptance ranges shall be sent to the District for evaluation.

With the approval of the Engineer, the ignition oven may be substituted for extractions according to the ITP, "Calibration of the Ignition Oven for the Purpose of Characterizing Reclaimed Asphalt Pavement (RAP)".

- (b) Evaluation of RAS and RAS Blended with Manufactured Sand Test Results. All of the test results, with the exception of percent unacceptable materials, shall be compiled and averaged for asphalt binder content and gradation. Individual test results, when compared to the averages, will be accepted if within the tolerances listed below.

Parameter	RAS
No. 8 (2.36 mm)	$\pm 5 \%$
No. 16 (1.18 mm)	$\pm 5 \%$
No. 30 (600 $\mu\text{m}$ )	$\pm 4 \%$
No. 200 (75 $\mu\text{m}$ )	$\pm 2.0 \%$
Asphalt Binder Content	$\pm 1.5 \%$

If more than 20 percent of the individual sieves and/or asphalt binder content tests are out of the above tolerances, or if the percent unacceptable material exceeds 0.5 percent by weight of material retained on the # 4 (4.75 mm) sieve, the RAS or RAS blend shall not be used in Department projects. All test data and acceptance ranges shall be sent to the District for evaluation.

**1031.05 Quality Designation of Aggregate in RAP/FRAP.**

- (a) RAP. The aggregate quality of the RAP for homogeneous and conglomerate stockpiles shall be set by the lowest quality of coarse aggregate in the RAP stockpile and are designated as follows.

- (1) RAP from Class I, Superpave/HMA (High ESAL), or (Low ESAL) IL-9.5L surface mixtures are designated as containing Class B quality coarse aggregate.
- (2) RAP from Class I binder, Superpave/HMA (High ESAL) binder, or (Low ESAL) IL-19.0L binder mixtures are designated as containing Class C quality coarse aggregate.

- (b) FRAP. If the Engineer has documentation of the quality of the FRAP aggregate, the Contractor shall use the assigned quality provided by the Engineer.

If the quality is not known, the quality shall be determined as follows. Coarse and fine FRAP stockpiles containing plus #4 (4.75 mm) sieve coarse aggregate shall have a maximum tonnage of 5000 tons (4500 metric tons). The Contractor shall obtain a representative sample witnessed by the Engineer. The sample shall be a minimum of 50 lb (25 kg).

The sample shall be extracted according to Illinois Modified AASHTO T 164 by a consultant laboratory prequalified by the Department for the specified testing. The consultant laboratory shall submit the test results along with the recovered aggregate to the District Office. The cost for this testing shall be paid by the Contractor. The District will forward the sample to the Bureau of Materials and Physical Research Aggregate Lab for MicroDeval Testing, according to ITP 327. A maximum loss of 15.0 percent will be applied for all HMA applications.

**1031.06 Use of RAP/FRAP and/or RAS in HMA.** The use of RAP/FRAP and/or RAS shall be the Contractor's option when constructing HMA in all contracts.

(a) RAP/FRAP. The use of RAP/FRAP in HMA shall be as follows.

- (1) Coarse Aggregate Size. The coarse aggregate in all RAP shall be equal to or less than the nominal maximum size requirement for the HMA mixture to be produced.
- (2) Steel Slag Stockpiles. Homogeneous RAP stockpiles containing steel slag will be approved for use in all HMA (High ESAL and Low ESAL) Surface and Binder Mixture applications.
- (3) Use in HMA Surface Mixtures (High and Low ESAL). RAP/FRAP stockpiles for use in HMA surface mixtures (High and Low ESAL) shall be FRAP or homogeneous in which the coarse aggregate is Class B quality or better. RAP/FRAP from Conglomerate stockpiles shall be considered equivalent to limestone for frictional considerations. Known frictional contributions from plus #4 (4.75 mm) homogeneous RAP and FRAP stockpiles will be accounted for in meeting frictional requirements in the specified mixture.
- (4) Use in HMA Binder Mixtures (High and Low ESAL), HMA Base Course, and HMA Base Course Widening. RAP/FRAP stockpiles for use in HMA binder mixtures (High and Low ESAL), HMA base course, and HMA base course widening shall be FRAP, homogeneous, or conglomerate, in which the coarse aggregate is Class C quality or better.
- (5) Use in Shoulders and Subbase. RAP/FRAP stockpiles for use in HMA shoulders and stabilized subbase (HMA) shall be FRAP, homogeneous, or conglomerate.
- (6) When the Contractor chooses the RAP option, the percentage of RAP shall not exceed the amounts indicated in Article 1031.06(c)(1) below for a given Ndesign.

(b) RAS. RAS meeting Type 1 or Type 2 requirements will be permitted in all HMA applications as specified herein.

(c) RAP/FRAP and/or RAS Usage Limits. Type 1 or Type 2 RAS may be used alone or in conjunction with RAP or FRAP in HMA mixtures up to a maximum of 5.0 percent by weight of the total mix.

- (1) RAP/RAS. When RAP is used alone or RAP is used in conjunction with RAS, the percentage of virgin asphalt binder replacement shall not exceed the amounts listed in the Max RAP/RAS ABR table listed below for the given Ndesign.

**RAP/RAS Maximum Asphalt Binder Replacement (ABR) Percentage**

HMA Mixtures <i>1/, 2/</i>	RAP/RAS Maximum ABR %		
Ndesign	Binder/Leveling Binder	Surface	Polymer Modified
30	30	30	10
50	25	15	10
70	15	10	10
90	10	10	10

1/ For Low ESAL HMA shoulder and stabilized subbase, the RAP/RAS ABR shall not exceed 50 percent of the mixture.

2/ When RAP/RAS ABR exceeds 20 percent, the high and low virgin asphalt binder grades shall each be reduced by one grade (i.e. 25 percent ABR would require a virgin asphalt binder grade of PG 64-22 to be reduced to a PG 58-28). If warm mix asphalt (WMA) technology is utilized and production temperatures do not exceed 275 °F (135 °C), the high and low virgin asphalt binder grades shall each be reduced by one grade when RAP/RAS ABR exceeds 25 percent (i.e. 26 percent RAP/RAS ABR would require a virgin asphalt binder grade of PG 64-22 to be reduced to a PG 58-28).

(2) FRAP/RAS. When FRAP is used alone or FRAP is used in conjunction with RAS, the percentage of virgin asphalt binder replacement shall not exceed the amounts listed in the FRAP/RAS table listed below for the given Ndesign.

**FRAP/RAS Maximum Asphalt Binder Replacement (ABR) Percentage**

HMA Mixtures <i>1/, 2/</i>	FRAP/RAS Maximum ABR %		
Ndesign	Binder/Leveling Binder	Surface	Polymer Modified <sup>3/, 4/</sup>
30	50	40	10
50	40	35	10
70	40	30	10
90	40	30	10

1/ For Low ESAL HMA shoulder and stabilized subbase, the FRAP/RAS ABR shall not exceed 50 percent of the mixture.

2/ When FRAP/RAS ABR exceeds 20 percent for all mixes, the high and low virgin asphalt binder grades shall each be reduced by one grade (i.e. 25 percent ABR would require a virgin asphalt binder grade of PG 64-22 to be reduced to a PG 58-28). If warm mix asphalt (WMA) technology is utilized and production temperatures do not exceed 275 °F (135 °C), the high and low virgin asphalt binder grades shall each be reduced by one grade when FRAP/RAS ABR exceeds 25 percent (i.e. 26 percent ABR would require a virgin asphalt binder grade of PG 64-22 to be reduced to a PG 58-28).

3/ For SMA the FRAP/RAS ABR shall not exceed 20 percent.

4/ For IL-4.75 mix the FRAP/RAS ABR shall not exceed 30 percent.

**1031.07 HMA Mix Designs.** At the Contractor's option, HMA mixtures may be constructed utilizing RAP/FRAP and/or RAS material meeting the detailed requirements specified herein.

- (a) RAP/FRAP and/or RAS. RAP/FRAP and/or RAS mix designs shall be submitted for verification. If additional RAP/FRAP and/or RAS stockpiles are tested and found that no more than 20 percent of the results, as defined under "Testing" herein, are outside of the control tolerances set for the original RAP/FRAP and/or RAS stockpile and HMA mix design, and meets all of the requirements herein, the additional RAP/FRAP and/or RAS stockpiles may be used in the original mix design at the percent previously verified.
- (b) RAS. Type 1 and Type 2 RAS are not interchangeable in a mix design. A RAS stone bulk specific gravity (Gsb) of 2.300 shall be used for mix design purposes.

**1031.08 HMA Production.** HMA production utilizing RAP/FRAP and/or RAS shall be as follows.

- (a) RAP/FRAP. The coarse aggregate in all RAP/FRAP used shall be equal to or less than the nominal maximum size requirement for the HMA mixture being produced.

To remove or reduce agglomerated material, a scalping screen, gator, crushing unit, or comparable sizing device approved by the Engineer shall be used in the RAP feed system to remove or reduce oversized material. If material passing the sizing device adversely affects the mix production or quality of the mix, the sizing device shall be set at a size specified by the Engineer.

If the RAP/FRAP control tolerances or QC/QA test results require corrective action, the Contractor shall cease production of the mixture containing RAP/FRAP and either switch to the virgin aggregate design or submit a new RAP/FRAP design.

- (b) RAS. RAS shall be incorporated into the HMA mixture either by a separate weight depletion system or by using the RAP weigh belt. Either feed system shall be interlocked with the aggregate feed or weigh system to maintain correct proportions for all rates of production and batch sizes. The portion of RAS shall be controlled accurately to within  $\pm 0.5$  percent of the amount of RAS utilized. When using the weight depletion system, flow indicators or sensing devices shall be provided and interlocked with the plant controls such that the mixture production is halted when RAS flow is interrupted.
- (c) RAP/FRAP and/or RAS. HMA plants utilizing RAP/FRAP and/or RAS shall be capable of automatically recording and printing the following information.

(1) Dryer Drum Plants.

- a. Date, month, year, and time to the nearest minute for each print.
- b. HMA mix number assigned by the Department.



- c. Accumulated weight of dry aggregate (combined or individual) in tons (metric tons) to the nearest 0.1 ton (0.1 metric ton).
- d. Accumulated dry weight of RAP/FRAP/RAS in tons (metric tons) to the nearest 0.1 ton (0.1 metric ton).
- e. Accumulated mineral filler in revolutions, tons (metric tons), etc. to the nearest 0.1 unit.
- f. Accumulated asphalt binder in gallons (liters), tons (metric tons), etc. to the nearest 0.1 unit.
- g. Residual asphalt binder in the RAP/FRAP material as a percent of the total mix to the nearest 0.1 percent.
- h. Aggregate and RAP/FRAP moisture compensators in percent as set on the control panel. (Required when accumulated or individual aggregate and RAP/FRAP are printed in wet condition.)

(2) Batch Plants.

- a. Date, month, year, and time to the nearest minute for each print.
- b. HMA mix number assigned by the Department.
- c. Individual virgin aggregate hot bin batch weights to the nearest pound (kilogram).
- d. Mineral filler weight to the nearest pound (kilogram).
- e. RAP/FRAP/RAS weight to the nearest pound (kilogram).
- f. Virgin asphalt binder weight to the nearest pound (kilogram).
- g. Residual asphalt binder in the RAP/FRAP/RAS material as a percent of the total mix to the nearest 0.1 percent.

The printouts shall be maintained in a file at the plant for a minimum of one year or as directed by the Engineer and shall be made available upon request. The printing system will be inspected by the Engineer prior to production and verified at the beginning of each construction season thereafter.

**1031.09 RAP in Aggregate Surface Course and Aggregate Wedge Shoulders, Type B.**

The use of RAP in aggregate surface course (temporary access entrances only) and aggregate wedge shoulders, Type B shall be as follows.

- (a) Stockpiles and Testing. RAP stockpiles may be any of those listed in Article 1031.02, except "Non-Quality" and "FRAP". The testing requirements of Article 1031.03 shall not apply. RAP used shall be according to the current Bureau of Materials and Physical Research Policy Memorandum, "Reclaimed Asphalt Pavement (RAP) for Aggregate Applications".

- (b) Gradation. One hundred percent of the RAP material shall pass the 1 1/2 in. (37.5 mm) sieve. The RAP material shall be reasonably well graded from coarse to fine. RAP material that is gap-graded or single sized will not be accepted.”

### **WARM MIX ASPHALT (BDE)**

Effective: January 1, 2012

Revised: April 1, 2016

Description. This work shall consist of designing, producing and constructing Warm Mix Asphalt (WMA) in lieu of Hot Mix Asphalt (HMA) at the Contractor’s option. Work shall be according to Sections 406, 407, 408, 1030, and 1102 of the Standard Specifications, except as modified herein. In addition, any references to HMA in the Standard Specifications, or the special provisions shall be construed to include WMA.

WMA is an asphalt mixture which can be produced at temperatures lower than allowed for HMA utilizing approved WMA technologies. WMA technologies are defined as the use of additives or processes which allow a reduction in the temperatures at which HMA mixes are produced and placed. WMA is produced by the use of additives, a water foaming process, or combination of both. Additives include minerals, chemicals or organics incorporated into the asphalt binder stream in a dedicated delivery system. The process of foaming injects water into the asphalt binder stream, just prior to incorporation of the asphalt binder with the aggregate.

Approved WMA technologies may also be used in HMA provided all the requirements specified herein, with the exception of temperature, are met. However, asphalt mixtures produced at temperatures in excess of 275 °F (135 °C) will not be considered WMA when determining the grade reduction of the virgin asphalt binder grade.

### Equipment.

Revise the first paragraph of Article 1102.01 of the Standard Specifications to read:

“**1102.01 Hot-Mix Asphalt Plant.** The hot-mix asphalt (HMA) plant shall be the batch-type, continuous-type, or dryer drum plant. The plants shall be evaluated for prequalification rating and approval to produce HMA according to the current Bureau of Materials and Physical Research Policy Memorandum, “Approval of Hot-Mix Asphalt Plants and Equipment”. Once approved, the Contractor shall notify the Bureau of Materials and Physical Research to obtain approval of all plant modifications. The plants shall not be used to produce mixtures concurrently for more than one project or for private work unless permission is granted in writing by the Engineer. The plant units shall be so designed, coordinated and operated that they will function properly and produce HMA having uniform temperatures and compositions within the tolerances specified. The plant units shall meet the following requirements.”

Add the following to Article 1102.01(a) of the Standard Specifications.

“(11) Equipment for Warm Mix Technologies.

- a. Foaming. Metering equipment for foamed asphalt shall have an accuracy of  $\pm 2$  percent of the actual water metered. The foaming control system shall be electronically interfaced with the asphalt binder meter.

- b. Additives. Additives shall be introduced into the plant according to the supplier's recommendations and shall be approved by the Engineer. The system for introducing the WMA additive shall be interlocked with the aggregate feed or weigh system to maintain correct proportions for all rates of production and batch sizes."

#### Mix Design Verification.

Add the following to Article 1030.04 of the Standard Specifications.

"(e) Warm Mix Technologies.

- (1) Foaming. WMA mix design verification will not be required when foaming technology is used alone (without WMA additives). However, the foaming technology shall only be used on HMA designs previously approved by the Department.
- (2) Additives. WMA mix designs utilizing additives shall be submitted to the Engineer for mix design verification."

#### Construction Requirements.

Revise the second paragraph of Article 406.06(b)(1) of the Standard Specifications to read:

"The HMA shall be delivered at a temperature of 250 to 350 °F (120 to 175 °C).  
WMA shall be delivered at a minimum temperature of 215 °F (102 °C)."

#### Basis of Payment.

This work will be paid at the contract unit price bid for the HMA pay items involved. Anti-strip will not be paid for separately, but shall be considered as included in the cost of the work.

#### **WEEKLY DBE TRUCKING REPORTS (BDE)**

Effective: June 2, 2012

Revised: April 2, 2015

The Contractor shall submit a weekly report of Disadvantaged Business Enterprise (DBE) trucks hired by the Contractor or subcontractors (i.e. not owned by the Contractor or subcontractors) that are used for DBE goal credit.

The report shall be submitted to the Engineer on Department form "SBE 723" within ten business days following the reporting period. The reporting period shall be Monday through Sunday for each week reportable trucking activities occur.

Any costs associated with providing weekly DBE trucking reports shall be considered as included in the contract unit prices bid for the various items of work involved and no additional compensation will be allowed.

**WORKING DAYS (BDE)**

Effective: January 1, 2002

The Contractor shall complete the work within **30** working days.

**BITUMINOUS MATERIALS COST ADJUSTMENTS (BDE) (RETURN FORM WITH BID)**

Effective: November 2, 2006

Revised: July 1, 2015

Description. Bituminous material cost adjustments will be made to provide additional compensation to the Contractor, or credit to the Department, for fluctuations in the cost of bituminous materials when optioned by the Contractor. The bidder shall indicate on the attached form whether or not this special provision will be part of the contract and submit the completed form with his/her bid. Failure to submit the form, or failure to fill out the form completely, shall make this contract exempt of bituminous materials cost adjustments.

The adjustments shall apply to permanent and temporary hot-mix asphalt (HMA) mixtures, bituminous surface treatments (cover and seal coats), and preventative maintenance type surface treatments that are part of the original proposed construction, or added as extra work and paid for by agreed unit prices. The adjustments shall not apply to bituminous prime coats, tack coats, crack filling/sealing, joint filling/sealing, or extra work paid for at a lump sum price or by force account.

Method of Adjustment. Bituminous materials cost adjustments will be computed as follows.

$$CA = (BPI_P - BPI_L) \times (\%AC_V / 100) \times Q$$

Where: CA = Cost Adjustment, \$.

BPI<sub>P</sub> = Bituminous Price Index, as published by the Department for the month the work is performed, \$/ton (\$/metric ton).

BPI<sub>L</sub> = Bituminous Price Index, as published by the Department for the month prior to the letting for work paid for at the contract price; or for the month the agreed unit price letter is submitted by the Contractor for extra work paid for by agreed unit price, \$/ton (\$/metric ton).

%AC<sub>V</sub> = Percent of virgin Asphalt Cement in the Quantity being adjusted. For HMA mixtures, the % AC<sub>V</sub> will be determined from the adjusted job mix formula. For bituminous materials applied, a performance graded or cutback asphalt will be considered to be 100% AC<sub>V</sub> and undiluted emulsified asphalt will be considered to be 65% AC<sub>V</sub>.

Q = Authorized construction Quantity, tons (metric tons) (see below).

For HMA mixtures measured in square yards:  $Q, \text{ tons} = A \times D \times (G_{mb} \times 46.8) / 2000$ . For HMA mixtures measured in square meters:  $Q, \text{ metric tons} = A \times D \times (G_{mb} \times 1) / 1000$ . When computing adjustments for full-depth HMA pavement, separate calculations will be made for the binder and surface courses to account for their different  $G_{mb}$  and % AC<sub>V</sub>.

For bituminous materials measured in gallons:  $Q, \text{ tons} = V \times 8.33 \text{ lb/gal} \times SG / 2000$

For bituminous materials measured in liters:  $Q, \text{ metric tons} = V \times 1.0 \text{ kg/L} \times SG / 1000$

Where: A = Area of the HMA mixture, sq yd (sq m).  
D = Depth of the HMA mixture, in. (mm).  
G<sub>mb</sub> = Average bulk specific gravity of the mixture, from the approved mix design.  
V = Volume of the bituminous material, gal (L).  
SG = Specific Gravity of bituminous material as shown on the bill of lading.

Basis of Payment. Bituminous materials cost adjustments may be positive or negative but will only be made when there is a difference between the BPI<sub>L</sub> and BPI<sub>P</sub> in excess of five percent, as calculated by:

$$\text{Percent Difference} = \{(BPI_L - BPI_P) \div BPI_L\} \times 100$$

Bituminous materials cost adjustments will be calculated for each calendar month in which applicable bituminous material is placed; and will be paid or deducted when all other contract requirements for the work placed during the month are satisfied. The adjustments shall not apply during contract time subject to liquidated damages for completion of the entire contract.

Return With Bid

**ILLINOIS DEPARTMENT  
OF TRANSPORTATION**

**OPTION FOR  
BITUMINOUS MATERIALS COST ADJUSTMENTS**

The bidder shall submit this completed form with his/her bid. Failure to submit the form, or failure to fill out the form completely, shall make this contract exempt of bituminous materials cost adjustments. After award, this form, when submitted, shall become part of the contract.

**Contract No.:** \_\_\_\_\_

**Company Name:** \_\_\_\_\_

**Contractor's Option:**

Is your company opting to include this special provision as part of the contract?

Yes  No

**Signature:** \_\_\_\_\_ **Date:** \_\_\_\_\_

## **VETERAN BUSINESS PROGRAM**

Effective: November 6, 2014

STATE OBLIGATION. This special provision will be used by the Department to satisfy the requirements of the Illinois Procurement Code, 30 ILCS 500/45-57. It is the goal of the State to promote and encourage the continued economic development of small businesses owned and controlled by qualified veterans and that qualified Service-Disabled Veteran-Owned Small Businesses (SDVOSB) and Veteran-Owned Small Businesses (VOSB) participate in the State's procurement process as both prime contractors and subcontractors.

CONTRACT GOAL TO BE ACHIEVED BY THE CONTRACTOR. This contract includes a specific Veteran Small Business participation goal of **0.00%** based on the availability of CMS certified veteran-owned and service-disabled veteran-owned small business (VOSB/SDVOSB) vendors to perform or provide the anticipated services and/or supplies required by this contract.

The Veteran Small Business participation goal is applicable to all bids. In addition to the other award criteria established for this contract, the Department will award this contract to a Vendor that meets the goal or makes good faith efforts to meet the goal. This goal is also applicable to change orders and allowances within the scope of work provided by the certified VOSB/SDVOSB vendor. If Vendor is a CMS certified VOSB/SDVOSB vendor, the entire goal is met and no subcontracting with a CMS certified VOSB/SDVOSB vendor is required; however, Vendor must submit a Utilization Plan indicating that the goal will be met by self-performance.

VETERAN SMALL BUSINESS CERTIFIED VENDOR LOCATOR REFERENCES. Vendors may consult CMS' Veteran Small Business Vendor Directory at [www.sell2.illinois.gov/cms/business](http://www.sell2.illinois.gov/cms/business) as well as the directories of other certifying agencies, but firms must be certified with CMS as VOSB/SDVOSB vendors at the time of bid/offer (see Title 44 Illinois Administrative Code Sec. 20.530).

BIDDING PROCEDURES. Compliance with this Special Provision is a material bidding requirement. The failure of the bidder to comply with this special provision will render the bid nonresponsive or not responsible.

At the time of the bid, Vendor, or Vendor's proposed subcontractor, must be certified with CMS as a VOSB or SDVOSB.

Following are guidelines for Vendor's completion of the Utilization Plan.

- (a) The bidder shall submit a Veteran Business Program (VBP) Utilization Plan. The format for the VBP Utilization Plan is included in this special provision.
- (b) Vendor should include any additional information that will add clarity to Vendor's proposed utilization of certified Veteran Small Business vendors to meet the targeted goal. The Utilization Plan must demonstrate that Vendor has either:
  - (1) met the entire contract goal;
  - (2) made good faith efforts towards meeting the entire goal; or

- (3) made good faith efforts towards meeting a portion of the goal. Any submission of good faith efforts by Vendor shall be considered as a request for a full or partial waiver.
- (c) If the bidder is a joint venture comprised of Veteran Business Enterprises (VBE) companies and non-VBE companies, the plan must also include:
  - (1) A clear identification of the portion of work to be performed by the VOSB/SDVOSB partner(s); and
  - (2) An agreement between a vendor and a certified VOSB/SDVOSB vendor in which a certified VOSB/SDVOSB vendor promises not to provide subcontracting or pricing quotations to other vendors is prohibited. The Department may request additional information to demonstrate compliance. Vendor agrees to cooperate promptly with the Department in submitting to interviews, allowing entry to places of business, providing further documentation, and to soliciting the cooperation of a proposed certified VOSB/SDVOSB vendor. Failure to cooperate by Vendor and certified VOSB/SDVOSB vendor may render the bidder nonresponsive or not responsible. The contract will not be awarded to Vendor unless Vendor's Utilization Plan is approved.

GOOD FAITH EFFORT PROCEDURES. Vendor must submit a Utilization Plans and Letters of Intent that meet or exceed the published goal. If Vendor cannot meet the stated goal, Vendor must document and explain within the Utilization Plan the good faith efforts it undertook to meet the goal. Utilization Plans are due at the time of bid. Vendors may not be permitted to correct goal deficiencies after bid due dates. The Department will consider the quality, quantity, and intensity of Vendor's efforts but if the Department determines that a Vendor did not demonstrate good faith efforts towards meeting the goal on the bid, the bid may be deemed nonresponsive or not responsible.

The Utilization Plan contains a checklist of actions that the Department will consider as evidence of Vendor's good faith efforts to meet the goal. Other factors or efforts brought to the attention of the Department may be relevant in appropriate cases.

- (a) In evaluating Vendor's good faith efforts, the Department may consider whether the ability of other bidders to meet the contract goal suggests that good faith efforts could have resulted in Vendor meeting the goal.
- (b) If the Department determines that Vendor has made good faith efforts to meet the goal, the Department may award the contract provided that Vendor is otherwise eligible for award.
- (c) If the Department determines that good faith efforts have not been met, the bidder may be determined to be nonresponsive or not responsible.

CALCULATING CERTIFIED VOSB/SDVOSB VENDOR PARTICIPATION. The Utilization Plan documents work anticipated to be performed by all certified VOSB/SDVOSB vendors and paid for upon satisfactory completion. The Department is only able to count toward the achievement of the overall goal and the contract goal the value of payments made for the work actually performed by the VOSB/SDVOSB vendors. Applicable guidelines for counting payments attributable to contract goals are listed below:

- (a) A Vendor shall count towards the goal only expenditures to firms that perform a commercially useful function in the work of the contract.



- (1) A firm is considered to perform a commercially useful function when it is responsible for execution of a distinct element of the work of a contract and carries out its responsibilities by actually performing, managing, and supervising the work involved. The certified VOSB/SDVOSB vendor must also be responsible, with respect to materials or supplies used on the contract, for negotiating price, determining quality and quantity, ordering the materials or supplies, and installing the materials (where applicable) and paying for the material or supplies. To determine whether a firm is performing a commercially useful function, the Department shall evaluate the amount of work subcontracted, whether the amount the firm is to be paid under the contract is commensurate with the work it is actually performing and the credit claimed for its performance of the work, industry practices, and other relevant factors.
  - (2) A certified VOSB/SDVOSB vendor does not perform a commercially useful function if its role is limited to that of an extra participant in a transaction or contract through which funds are passed through in order to obtain certified VOSB/SDVOSB vendor participation. In determining whether a certified VOSB/SDVOSB vendor is such an extra participant, the Department shall examine similar transactions, particularly those in which certified VOSB/SDVOSB vendors do not participate, and industry practices.
- (b) The value of the work actually performed or goods/equipment provided by the certified VOSB/SDVOSB vendor shall be counted towards the goal. The entire amount of that portion of the contract that is performed by the certified VOSB/SDVOSB vendor, including supplies purchased or equipment leased by the certified VOSB/SDVOSB vendor shall be counted, except supplies purchased and equipment rented from the Prime Vendor submitting this bid.
  - (c) A vendor shall count the portion of the total dollar value of the Veteran Small Business contract equal to the distinct, clearly defined portion of the work of the contract that the certified VOSB/SDVOSB vendor performs toward the goal. A vendor shall also count the dollar value of work subcontracted to other certified VOSB/SDVOSB vendor. Work performed by the non-certified VOSB/SDVOSB party shall not be counted toward the goal. Work that a certified VOSB/SDVOSB vendor subcontracts to a non-certified VOSB/SDVOSB vendor will not count towards the goal.
  - (d) A Vendor shall count toward the goal 100% of its expenditures for materials and supplies required under the contract and obtained from a certified VOSB/SDVOSB vendor manufacturer, regular dealer, or supplier. A Vendor shall count toward the goal the following expenditures to certified VOSB/SDVOSB vendors that are not manufacturers, regular dealers, or suppliers.
    - (1) The fees or commissions charged for providing a bona fide service, such as professional, technical, consultant or managerial services and assistance in the procurement of essential personnel, facilities, equipment, materials or supplies required for performance of the contract, provided that the fee or commission is determined by the Department to be reasonable and not excessive as compared with fees customarily allowed for similar services.
    - (2) The fees charged for delivery of materials and supplies required by the contract (but not the cost of the materials and supplies themselves) when the hauler, trucker, or

delivery service is not also the manufacturer or a supplier of the materials and supplies being procured, provided that the fee is determined by the Department to be reasonable and not excessive as compared with fees customarily allowed for similar services. The certified VOSB/SDVOSB vendor's trucking firm must be responsible for the management and supervision of the entire trucking operation for which it is responsible on the contract, and must itself own and operate at least one fully licensed, insured and operational truck used on the contract.

- (3) The fees or commissions charged for providing any bonds or insurance specifically required for the performance of the contract, provided that the fee or commission is determined by the Department to be reasonable and not excessive as compared with fees customarily allowed for similar services.
- (e) Certified VOSB/SDVOSB vendors who are performing on contract as second tier subcontractors may be counted in meeting the established Veteran Small Business goal for this contract as long as the Prime Vendor can provide documentation indicating the utilization of these vendors.
- (f) A Vendor shall not count towards the goal expenditures that are not direct, necessary and related to the work of the contract. Only the amount of services or goods that are directly attributable to the performance of the contract shall be counted. Ineligible expenditures include general office overhead or other Vendor support activities.

CONTRACT COMPLIANCE. Compliance with this section is an essential part of the contract. The following administrative procedures and remedies govern Vendor's compliance with the contractual obligations established by the Utilization Plan. After approval of the Plan and award of the contract, the Utilization Plan becomes part of the contract. If Vendor did not succeed in obtaining certified VOSB/SDVOSB vendor participation to achieve the goal and the Utilization Plan was approved and contract awarded based upon a determination of good faith, the total dollar value of certified VOSB/SDVOSB vendor work calculated in the approved Utilization Plan as a percentage of the awarded contract value shall become the contract goal. Vendors are encouraged to seek VOSB/SDVOSB firms during the course of performing the contract.

- (a) NO AMENDMENT. The Utilization Plan may not be amended after contract execution without the Department's prior written approval.
- (b) CHANGES TO WORK. Vendor may not make changes to its contractual certified VOSB/SDVOSB vendor commitments or substitute certified VOSB/SDVOSB vendors without the prior written approval of the Department. Unauthorized changes or substitutions, including performing the work designated for a certified VOSB/SDVOSB vendor with Vendor's own forces, shall be a violation of the utilization plan and a breach of the contract, and shall be cause to terminate the contract, and/or seek other contract remedies or sanctions. The facts supporting the request for changes must not have been known nor reasonably should have been known by the parties prior to entering into the subcontract. Vendor must negotiate with the certified VOSB/SDVOSB vendor to resolve the problem. Where there has been a mistake or disagreement about the scope of work or goods/equipment, provided the certified VOSB/SDVOSB vendor can be substituted only where agreement cannot be reached for a reasonable price or schedule for the correct scope of work, goods or equipment.

Substitutions of a certified VOSB/SDVOSB vendor may be permitted under the following circumstances and possibly others on a case-by-case basis:

- (1) Unavailability after receipt of reasonable notice to proceed;
- (2) Failure of performance;
- (3) Financial incapacity;
- (4) Refusal by the certified VOSB/SDVOSB vendor to honor the bid or proposal price or scope;
- (5) Material mistake of fact or law about the elements of the scope of work of a solicitation where a reasonable price cannot be agreed;
- (6) Failure of the certified VOSB/SDVOSB vendor to meet insurance, licensing or bonding requirements;
- (7) The certified VOSB/SDVOSB vendor's withdrawal of its bid or offer; or
- (8) Decertification of the certified VOSB/SDVOSB vendor.

If it becomes necessary to substitute a certified VOSB/SDVOSB vendor or otherwise change the Utilization Plan, Vendor must notify the Department in writing of the request to substitute a certified VOSB/SDVOSB vendor or otherwise change the Utilization Plan. The request must state specific reasons for the substitution or change. The Department will approve or deny a request for substitution or other change in the Utilization Plan within five business days of receipt of the request.

Where Vendor has established the basis for the substitution to the Department's satisfaction, it must make good faith efforts to meet the contract goal by substituting a certified VOSB/SDVOSB vendor. Documentation of a replacement certified VOSB/SDVOSB vendor, or of good faith efforts to replace the certified VOSB/SDVOSB vendor, must meet the requirements of the initial Utilization Plan. If the goal cannot be reached and good faith efforts have been made, Vendor may substitute with a non-certified VOSB/SDVOSB vendor or Vendor may perform the work.

When adding a VOSB/SDVOSB, a new certified VOSB/SDVOSB vendor agreement should be executed and submitted to the Department with the appropriate subcontractor approval forms prior to the subcontractor's performance of work on the project.

Vendor shall maintain a record of all relevant data with respect to the utilization of certified VOSB/SDVOSB vendors. Full access to these records shall be granted by Vendor upon 48 hours written demand by the Department to any duly authorized representative thereof, or to any municipal, state or federal authorities. The Department shall have the right to obtain from Vendor any additional data reasonably related or necessary to verify any representations by Vendor. After the performance of the final item of work or delivery of material by the certified VOSB/SDVOSB vendor and final payment to the certified VOSB/SDVOSB vendor by Vendor, but not later than 15 calendar days after such payment, Vendor shall submit a statement confirming the final payment and the total payments made to the certified VOSB/SDVOSB vendor under the contract.

The Department will periodically review Vendor's compliance with these provisions and the terms of its contract. Without limitation, Vendor's failure to comply with these provisions or its contractual commitments as contained in the Utilization Plan, failure to cooperate in providing information regarding its compliance with these provisions or its Utilization Plan, or provision of false or misleading information or statements concerning compliance, certification status or eligibility of the certified VOSB/SDVOSB vendor, good faith efforts or any other material fact or representation shall constitute a material breach of this contract and entitle the Department to declare a default, terminate the contract, or exercise those remedies provided for in the contract or at law or in equity.

The Department reserves the right to withhold payment to Vendor to enforce these provisions and Vendor's contractual commitments. Final payment shall not be made pursuant to the contract until Vendor submits sufficient documentation demonstrating compliance with its Utilization Plan.

**\*\*RETURN WITH BID\*\***

**VETERAN BUSINESS PROGRAM (VBP) UTILIZATION PLAN**

The VBP Utilization Plan includes the Letters of Intent and Good Faith Efforts.

(Vendor)\_\_\_\_\_ submits the following Utilization Plan as part of our bid or offer in accordance with the requirements of the (VBP). We understand that all subcontractors must be certified with the CMS Veteran Small Business Program at the time of submission of all bids. We understand that compliance with this section is an essential part of this contract and that the Utilization Plan will become a part of the contract, if awarded.

Vendor submits the following statement:

- \_\_\_ Vendor is a certified VOSB/SDVOSB and plans to fully meet the goal through self-performance.
- \_\_\_ Vendor has identified certified VOSB/SDVOSB subcontractor(s) to fully meet the established goal and submits the attached completed Letter(s) of Intent; or
- \_\_\_ Vendor has made good faith efforts towards meeting the entire goal, or a portion of the goal, and hereby requests a waiver (complete checklist below).

**\*\*RETURN WITH BID\*\***

Vendor's person responsible for compliance:

Name: Title:

Telephone: Email

**DEMONSTRATION OF GOOD FAITH EFFORTS TO ACHIEVE GOAL AND REQUEST FOR WAIVER**

If the Veteran Small Business participation goal was not achieved, the Good Faith Efforts Procedures and Guidelines outlined in Contract Compliance will be used to evaluate submitted utilization plans. Vendors providing Good Faith Effort documentation and request for waiver must complete and submit the Good Faith Effort Contact Log with the bid or offer. Failure to submit Good Faith Effort documentation in its entirety shall render Vendor's bid nonresponsive or not responsible and cause it to be rejected or render Vendor ineligible for contract award. Insufficient Good Faith Effort documentation may render the bidder nonresponsive or not responsible.

Below is a checklist of actions that will be used to evaluate a Vendor's Demonstration of Good Faith Efforts and Request for Waiver. Please check the actions which you completed. If any of the following actions are not completed, please attach a detailed written explanation indicating why such action was not completed. If any other efforts were made to obtain Veteran Small Business participation in addition to the items listed below, attach a detailed description of such efforts.

\_\_\_\_\_ Utilize the Sell2Illinois website: [www2.illinois.gov/cms/business](http://www2.illinois.gov/cms/business) to identify certified VOSB/SDVOSB vendors within the respective commodity/service codes denoted above and at a minimum email all listed vendors and solicit quotes from all vendors who express an interest via follow-up emails or telephone calls.

\_\_\_\_\_ Solicit through all reasonable and available means (e.g., attendance at a vendor conference, advertising and/or written notices) the interest of certified VOSB/SDVOSB vendors that have the capability to perform the work of the contract. Vendor must solicit this interest within sufficient time to allow the certified VOSB/SDVOSB vendors to respond to the solicitation. Vendor must determine with certainty if the certified VOSB/SDVOSB vendors are interested by taking appropriate steps to follow up initial solicitations and encourage them to submit a bid or proposal. Vendor must provide interested certified VOSB/SDVOSB vendors with adequate information about the plans, specifications, and requirements of the contract in a timely manner to assist them in responding promptly to the solicitation.

\_\_\_\_\_ Select portions of the work to be performed by certified VOSB/SDVOSB vendors in order to increase the likelihood that the goal will be achieved. This includes, where appropriate, breaking out contract work items into economically feasible units to facilitate certified VOSB/SDVOSB vendor participation, even when Vendor might otherwise prefer to perform these work items with its own forces.

\_\_\_\_\_ Make a portion of the work available to certified VOSB/SDVOSB vendors and selecting those portions of the work or material needs consistent with their availability, so as to facilitate certified VOSB/SDVOSB vendor participation.

**\*\*RETURN WITH BID\*\***

- \_\_\_\_\_ Negotiate in good faith with interested certified VOSB/SDVOSB vendors. Evidence of such negotiation must include the names, addresses, email addresses, and telephone numbers of certified VOSB/SDVOSB vendors that were considered; a description of the information provided regarding the plans and specifications for the work selected for subcontracting and evidence as to why additional agreements could not be reached for certified VOSB/SDVOSB vendors to perform the work. A Vendor using good business judgment may consider a number of factors in negotiating with certified VOSB/SDVOSB vendors and may take a firm's price and capabilities into consideration. The fact that there may be some additional costs involved in finding and using certified VOSB/SDVOSB vendors may not be in itself sufficient reason for a Vendor's failure to meet the goal, as long as such costs are reasonable. Vendors are not required to accept higher quotes from certified VOSB/SDVOSB vendors if the price difference is excessive or unreasonable.
  
- \_\_\_\_\_ Thoroughly investigate the capabilities of certified VOSB/SDVOSB vendors and not reject them as unqualified without documented reasons.
  
- \_\_\_\_\_ Make efforts to assist interested certified VOSB/SDVOSB vendors in obtaining lines of credit or insurance as required by the State.
  
- \_\_\_\_\_ Make efforts to assist interested certified VOSB/SDVOSB vendors in obtaining necessary equipment, supplies, materials, or related assistance or services.

**\*\*RETURN WITH BID\*\***

**GOOD FAITH EFFORTS CONTACT LOG**

Use this Log to document all contacts and responses (telephone, e-mail, fax, etc.) regarding the solicitation of certified VOSB/SDVOSB vendors within the specific scope of work selected. It is not necessary to show contacts with certified VOSB/SDVOSB vendors who are identified on the Letter(s) of Intent. Keep and submit copies of all emails sent and received from prospective vendors. Include a copy of the commodity list or scope of work you solicited prospective vendors to perform. Duplicate this log as necessary; do not limit your contacts to the number of spaces shown.

Name of Certified Veteran Small Business Vendor	Date	Method of Contact	Scope of Work Solicited	Reason Agreement Was Not Reached



**\*\*RETURN WITH BID\*\***

**LETTER OF INTENT (LOI)**

**BETWEEN PRIME VENDOR AND CERTIFIED VETERAN SMALL BUSINESS VENDOR**

Instructions: The Bidder is required to submit a separate, signed LOI from each identified certified VOSB/SDVOSB vendor (hereinafter "certified vendors"). **LOIs must be submitted with the Bid and must be signed by both parties.** The Prime Bidder shall not prohibit or otherwise limit certified vendor(s) from providing bids or quotes to other potential bidders. Each LOI shall include the dollar amount, percentage, and scope of work to be performed by each identified certified vendor. All LOI's shall be subject to Department approval.

Any changes involving or affecting the identified certified vendor(s) may not be permitted without written approval of the Department.

Contract Number:

Name of Vendor:

Name of Contact Person:

Address:

City, State and Zip:

Telephone: Fax: Email:

Name of Certified Veteran Small Business Vendor: Name of Contact Person:

Address:

City, State and Zip:

Telephone: Fax: Email:

Proposed % of Contract to be performed by the certified vendor firm: \_\_\_\_\_%

Proposed dollar amount of Contract to be performed by the certified vendor: \$\_\_\_\_\_

Description of work to be performed by the certified vendor firm:

Vendor and the Certified vendor above hereby agree that upon the execution of a contract for the above-named project between Bidder and the State of Illinois, the certified vendor will perform the scope of work for the percentage as indicated above.

Bidder (Company Name or D/B/A):

Certified Vendor (Company Name or D/B/A):

Signature:

Signature:

Printed Name:

Printed Name:

Title:

Title:

Date:

Date:

STATE OF ILLINOIS  
DEPARTMENT OF TRANSPORTATION  
DIVISION OF HIGHWAYS

**PROPOSED  
HIGHWAY PLANS**

F.A.S. ROUTE 55 (IL70)  
SECTION 102RS-3  
PROJECT IL 70 CAPE SEAL  
WINNEBAGO COUNTY

FOR INDEX OF SHEETS, SEE SHEET NO. 2

TOWNSHIP (SECTION) DURAND (22, 21, 34, 35, 36)  
HARRISON (31) BURNETT (4)



ALL SIZE PLANS HAVE BEEN PREPARED USING STANDARD ENGINEERING SCALES. REDUCED SIZED PLANS WILL NOT CONFORM TO STANDARD SCALES. IN MAKING MEASUREMENTS ON REDUCED PLANS, THE ABOVE SCALES MAY BE USED.

JULIE  
JOINT UTILITY LOCATION INFORMATION FOR EXCAVATION  
1-800-892-9023  
OR 811

PROJECT ENGINEER: STEVEN ROBERY  
STUDIES AND PLANS SQUAD ENGINEER: PAUL DREZEN (815) 284-5512  
EMAIL Paul.Drezen@illinois.gov  
CONTRACT NO. 64L37

F.A.S. RTE. 55 (IL70)	SECTION 102RS-3	COUNTY WINNEBAGO	TOTAL SHEETS 50	SHEET NO. 1
ILLINOIS		CONTRACT NO. 64L37		
D-92-055-16				

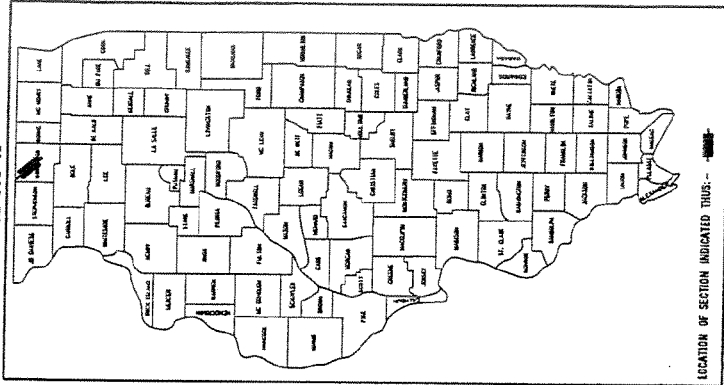

LOCATION OF SECTION INDICATED THEREIN

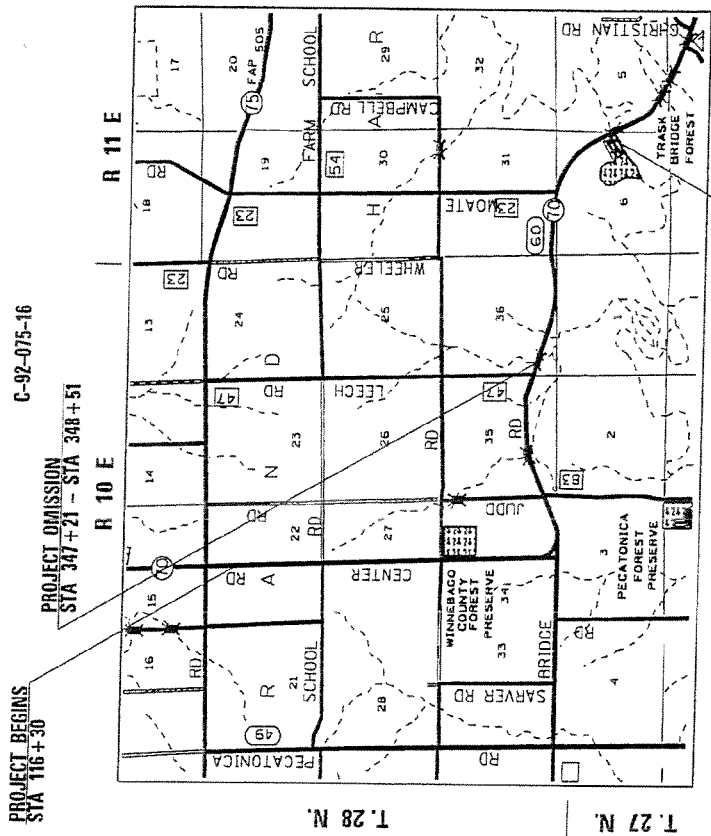

STATE OF ILLINOIS  
DEPARTMENT OF TRANSPORTATION  
DIVISION OF HIGHWAYS

SUBMITTED March 18<sup>th</sup> 2016

Paul Drezen REGIONAL ENGINEER

\_\_\_\_\_  
ENGINEER OF DESIGN AND ENVIRONMENT

\_\_\_\_\_  
DIRECTOR OF HIGHWAYS, CHIEF ENGINEER

DISTRICT 2, DIXON  
PRINTED BY THE AUTHORITY  
OF THE STATE OF ILLINOIS

GROSS LENGTH = 34,158 FT. = 6.47 MILES  
NET LENGTH = 34,028 FT. = 6.45 MILES

# INDEX

FAS 55 (IL 70)  
Section 102RS-3  
Winnebago County  
Contract No. 64L37  
Sheet 2 of 50

1	Cover Sheet
2	Index of Sheets / State Standards
3	Summary of Quantities
4-6	General Notes
7-9	Typical Sections
10-12	Schedule of Quantities
13-47	Plan Sheets
48-50	Typical Pavement Markings (DS 41.1)

## STATE STANDARDS

701006-05	OFF-ROAD OPERATIONS, 2L, 2W 15' TO 24" FROM PAVEMENT EDGE
701011-04	OFF-ROAD MOVING OPERATIONS, 2L, 2W, DAY ONLY
701201-04	LANE CLOSURE, 2L, 2W, DAY ONLY, FOR SPEEDS $> 45$ MPH
701301-04	LANE CLOSURE, 2L, 2W, SHORT TIME OPERATIONS
701306-03	LANE CLOSURE, 2L, 2W, SLOW MOVING OPERATIONS DAY ONLY, FOR SPEEDS $\geq 45$ MPH
701311-03	LANE CLOSURE, 2L, 2W, MOVING OPERATIONS - DAY ONLY
701901-05	TRAFFIC CONTROL DEVICES
720011-01	METAL POST FOR SIGNS, MARKERS AND DELINEATORS
728001-01	TELESCOPING STEEL SIGN SUPPORT
729001-01	APPLICATIONS OF TYPES A & B METAL POSTS (FOR SIGNS & MARKERS)
780001-05	TYPICAL PAVEMENT MARKINGS
781001-04	TYPICAL APPLICATIONS RAISED REFLECTIVE PAVEMENT MARKERS

**SUMMARY OF QUANTITIES**

FAS 55 (IL 70)  
 Section 102 RS-3  
 Winnebago County  
 Contract #64L37  
 Sheet 3 of 50

0005  
 100%  
 STATE

CODE NO.	ITEM	UNIT	TOTAL QUANTITY
40600525	LEVELING BINDER (HAND METHOD), N50	TON	11
67100100	MOBILIZATION	L SUM	1
70100450	TRAFFIC CONTROL AND PROTECTION, STANDARD 701201	L SUM	1
70100460	TRAFFIC CONTROL AND PROTECTION, STANDARD 701306	L SUM	1
70300100	SHORT TERM PAVEMENT MARKING	FOOT	4993
70300150	SHORT TERM PAVEMENT MARKING REMOVAL	SQ FT	1665
78000100	THERMOPLASTIC PAVEMENT MARKING -LETTERS AND SYMBOLS	SQ FT	47
78000200	THERMOPLASTIC PAVEMENT MARKING -LINE 4"	FOOT	5480
78000500	THERMOPLASTIC PAVEMENT MARKING -LINE 8"	FOOT	949
78000600	THERMOPLASTIC PAVEMENT MARKING -LINE 12"	FOOT	549
78001110	PAINT PAVEMENT MARKING - LINE 4 INCH	FOOT	221107
78100100	RAISED REFLECTIVE PAVEMENT MARKER	EACH	538
78300100	PAVEMENT MARKING REMOVAL	SQ FT	37689
78300200	RAISED REFLECTIVE PAVEMENT MARKER REMOVAL	EACH	448
Z0040315	PILOT CAR	CAL DAY	4
Z0064265	CAPE SEAL	SQ YD	97132
X0326218	FIBER-MODIFIED ASPHALT CRACK SEALING	FOOT	11386
X0326219	BUMP REMOVAL	EACH	100
X7810400	TEMPORARY RAISED REFLECTIVE PAVEMENT MARKER	EACH	9781

\* Specialty Items

### GENERAL NOTES

All Borrow/Waste/Use sites must be approved by the Department prior to removing any material from the project or initiating any earthmoving activities, including temporary stockpiling outside the limits of construction.

The Contractor will be required to furnish 5 1/2" high brass stencils as approved by the Engineer and install stationing at 250' intervals. Stationing shall be placed on both lanes of 2-lane highways and on the outside lanes in both directions on 4-lane highways. The stations shall be placed 6" inside the pavement marking edge so they can be read from the shoulder. This work will be included in the cost of the final pavement surface.

The area to be tacked or primed shall be limited to that which can be covered with HMA on the next day's production, but no more than five days in advance of the placement of the HMA, unless approved by the Engineer.

If, during the grinding or resurfacing operations, the existing mailboxes become a hindrance, the Contractor shall be required to carefully remove and reinstall the mailboxes as directed by the Engineer. This work shall be included in the contract unit price for the INCIDENTAL HOT-MIX ASPHALT SURFACING.

Pavement Marking shall be done according to Standard 780001, except as follows:

1. All words, such as ONLY, shall be 8 feet high.
2. All non-free-way arrows shall be the large size.
3. The distance between yellow no-passing lines shall be 8 inches, not 7 inches, as shown in the detail of Typical Lane and Edge Lines.
4. Centerline Skip Dash Pavement Marking on multi-lane divided, multi-lane undivided, and one-way roadway shall be according to District Standard 41.1.

The Contractor shall be responsible for locating and protecting utility property during construction operations as outlined in Article 107.39 of the Standard Specifications. A minimum of 48 hours advance notice is required for non-emergency work. The JULIE number is 800-892-0123. The following listed utilities located within the project limits or immediately adjacent to the project construction limits are members of JULIE:

Commonwealth Edison (815) 490-2869  
Frontier (815) 544-6171  
NICOR Gas (630) 388-3046  
Windstream (815) 592-3395

IDOT is not a member of JULIE. If you are near any overhead lighting, intersection lighting or traffic signals, contact the IDOT Traffic Office at 815/284-5469 at least 48 hours prior to work.

The Contractor and Engineer shall be aware that a current survey was not performed for this project. The stationing, topography, and quantities shown on these plans were created using previous surveys and field measurements, all of which shall be assumed approximate. The Contractor shall verify dimensions and conditions in the field prior to construction and ordering of materials.

Proposed pavement markings shall be placed in the same location as existing, or as directed by the Resident Engineer.

The Contractor shall post and maintain the roadway with "no passing zones not striped next miles" signs until markings have been restored in accordance with Article 701.17(c). All costs shall be included in the cost of the applicable traffic control and protection item.

A quantity for fiber modified asphalt crack sealing and bump removal has been estimated from a field review and included in the plans for use at locations as directed by the Resident Engineer. The Contractor and Resident Engineer shall examine the roadway surface together, prior to the Contractor beginning work, in order to determine pre-treatment locations. Applicable traffic control and protection shall be in place for this inspection. The actual quantity of material shall be determined during construction.

Cape sealing through intersections, right turn lanes, and at the ends of the project shall have the edges tapered/feathered out two to three feet beyond the edge of the mat. The cost for tapers shall be included in the contract unit price for cape seal, with pay limits where cape sealing ends.

The following Mixture Requirements are applicable for this project:

Mixture Uses(s):	Level Binder (HM)	64-22	
Design Air Voids	4.0@N50		
Mixture Composition (Gradation Mixture)	IL 9.5		
Fricion Aggregate			
20 Year ESAL			
Quality Management Program to be Used			
Mix Unit Weight	112LBS/SY/IN		

The existing rumble strips near the beginning of the project shall be covered prior to cape seal applications. The cover shall be removed after the cape seal application is completed. This work shall be included in the cost of the "cape seal".

The Contractor has the option to complete the project with one of the following methods:

Option #1

The Contractor shall begin by placing one of two passes on the lane without existing centerline pavement striping prior to placing cape sealing on the lane with existing centerline markings. After the Contractor has completed two passes on the lane without centerline markings they shall begin work in the lane with the existing centerline markings. The Contractor shall place short-term pavement markings (tape) or the first application of paint pavement marking on the previously laid lane (which shall have an overnight cure period) prior to opening the section to traffic.

Option #2

The Contractor shall place the first pass on each lane (commencing with the lane without existing centerline pavement markings) and prior to opening a section of the mainline to traffic and shall place short-term pavement markings by use of paint, no tape will be allowed. The second pass of cape sealing shall have short-term pavement markings placed (tape) or the first application of paint pavement marking.

The Contractor shall wait a period of 14 days with good drying weather (to allow the new surface to fully cure) before applying the second application of paint pavement markings.

Micro-surfacing, single pass, Type II shall be used at a rate of 24 lb./sq. yard. If slag sand FA 20 is used the rate shall be 29 lb./sq. yard.

# TYPICAL SECTIONS

STA 116+30 - 172+85  
 STA 191+80 - 215+11  
 STA 228+03 - 247+71

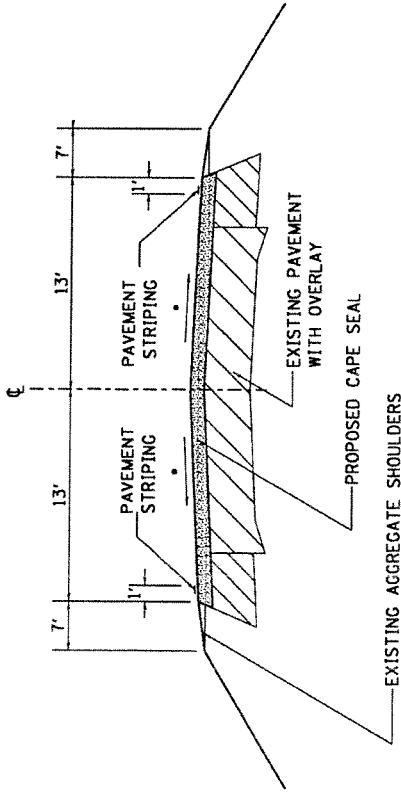

RT STA 172+85 - 177+33  
 LT STA 185+00 - 190+36  
 RT STA 185+00 - 191+80  
 LT STA 215+11 - 228+03  
 LT STA 357+00 - 360+35

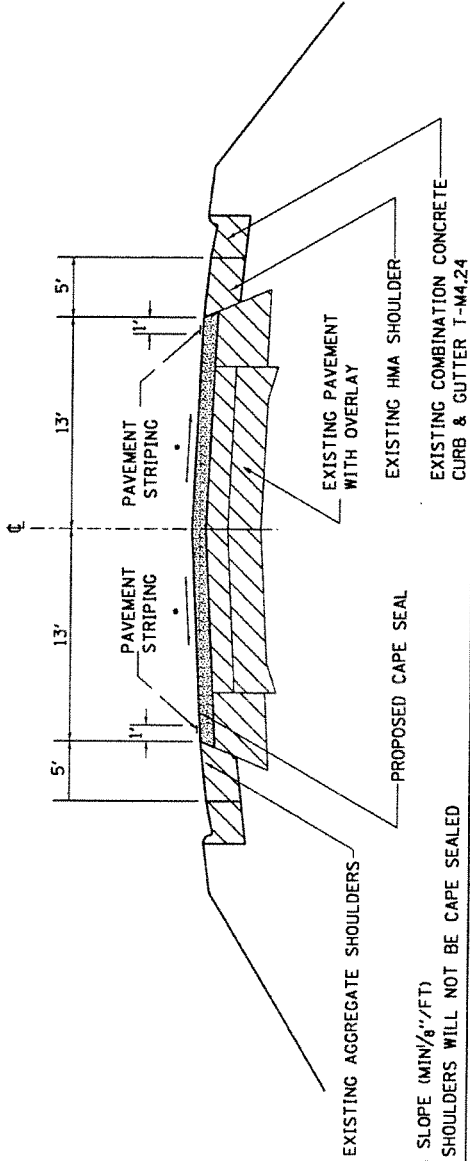

• MAINTAIN EXISTING CROSS SLOPE (MIN/6"/FT)  
 RT TURN LANES AND HMA SHOULDERS WILL NOT BE CAPE SEALED

FILE NAME = 0:\Projects\Winnebago\64L37_IL70_Cape_Seal_From_IL_75_to_Pecatonica_River\01d_IL70_Project\02\610_sht-typical.dgn		TYPICAL SECTIONS	
USER NAME = goffj		F.A.S. RTE. 55	SECTION 102RS-3
PLOT DATE = Mar-08-2016 06:55:21 AM		COUNTY WINNEBAGO	TOTAL SHEETS 50
		FED. ROAD DIST. NO. - ILLINOIS	SHEET NO. 7
		CONTRACT NO. 64L37	FED. AID PROJECT



# TYPICAL SECTIONS

STA 247+71 - 256+71  
 STA 271+09 - 338+18  
 STA 342+24 - 419+32  
 STA 424+34 - 457+88

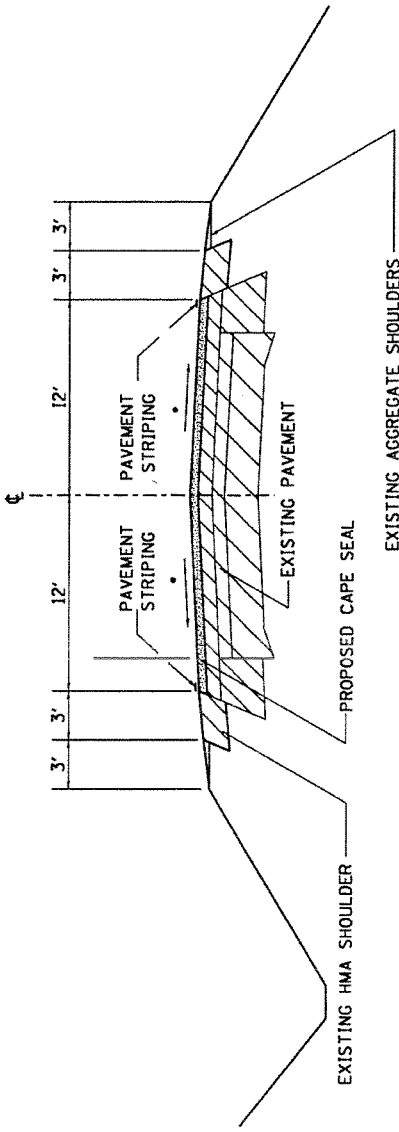

STA 256+71 - 271+09

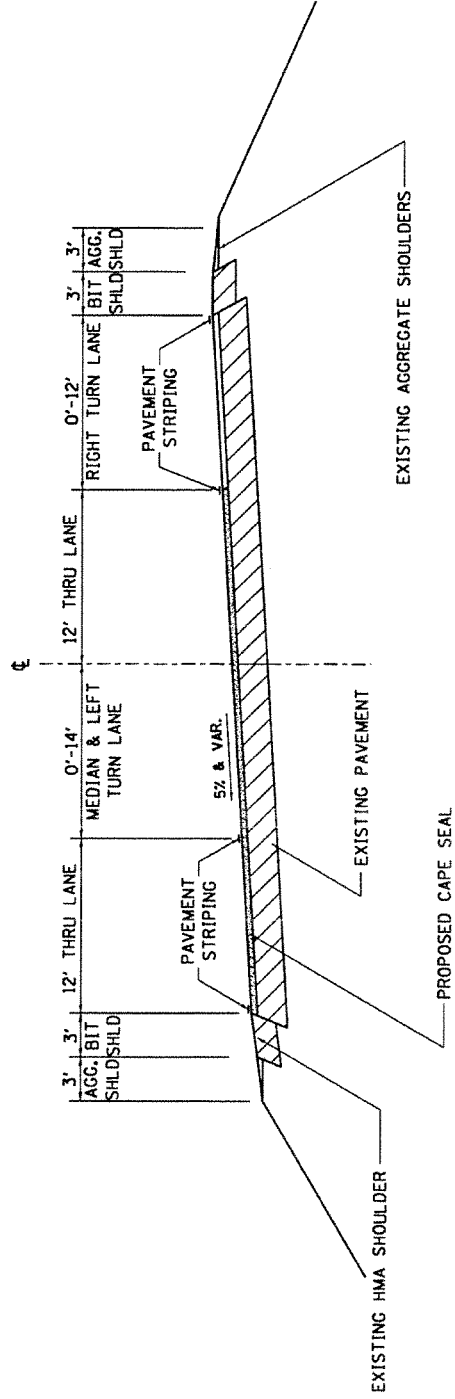

- MAINTAIN EXISTING CROSS SLOPE (MIN/6"/FT)  
RT TURN LANES AND HMA SHOULDERS WILL NOT BE CAPE SEALED

FILE NAME = D:\Projects\winnebago\64L37_IL70_Cape_Seal_From_IL_75_to_Peatonlea_River\01\0201619-sit-typical.dgn		<b>TYPICAL SECTIONS</b>	
USER NAME = gsrffjl		<b>STATE OF ILLINOIS</b> <b>DEPARTMENT OF TRANSPORTATION</b>	
PLOT DATE = Mar-08-2016 06:55:32 AM		FEDERAL ROAD DIST. NO. - ILLINOIS - FED. AID PROJECT	
F.A.S. R.I.E. - 55	SECTION - 102RS-3	COUNTY - WINNEBAGO	TOTAL SHEETS - 90
			SHEET NO. - 8
			CONTRACT NO. 64L37

# TYPICAL SECTIONS

STA 338+18 - 342+24  
 STA 419+32 - 424+34

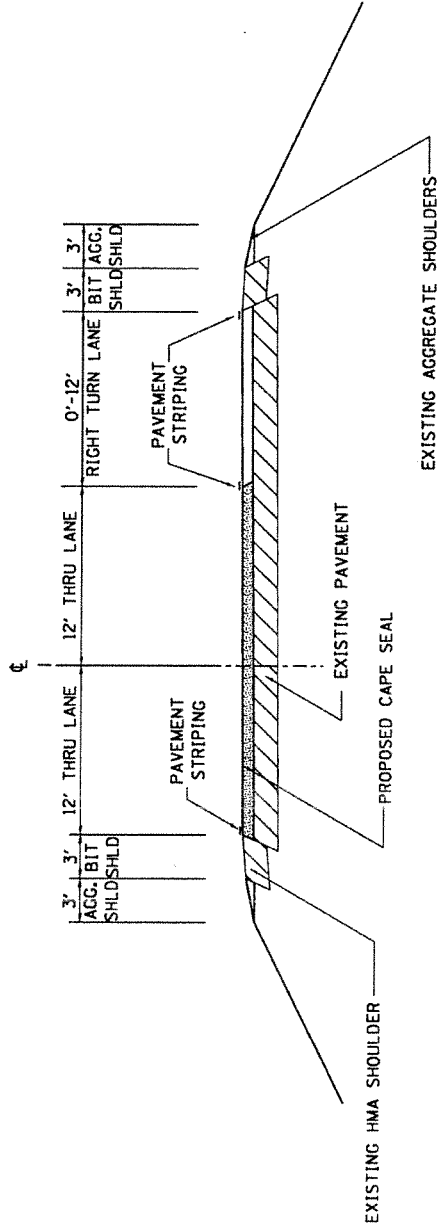

- MAINTAIN EXISTING CROSS SLOPE (MIN/6"/FT)
- RT TURN LANES AND HMA SHOULDERS WILL NOT BE CAPE SEALED

FILE NAME = D:\Projects\Winnebago\64L37_IL70_Cape_Seal_From_IL_75_to_Pecatonica_River\01d_IL70_Projects\02016\0-shd-typical.dgn		<b>STATE OF ILLINOIS</b> <b>DEPARTMENT OF TRANSPORTATION</b>		<b>TYPICAL SECTIONS</b>	
USER NAME = goffj		F.A.S. R.T.E. = 55		SECTION = 102RS-3	
PLOT DATE = Mar-08-2016 06:55:41 AM		COUNTY = WINNEBAGO		TOTAL SHEETS = 50	
		FED. ROAD DIST. NO. = ILLINOIS		CONTRACT NO. = 64L37	

**SCHEDULE OF QUANTITIES**

FAS 55 (IL 70)  
 Section 102RS-3  
 Winnebago County  
 Contract #64L37  
 Sheets 10 of 50

**40600525 LEVELING BINDER (HAND METHOD), N50**

LOCATION	IL 70	STA. 116+30 - 459+25	TOTAL	11
REMARKS	TON	RRPM Removal Holes		11

**70300100 SHORT TERM PAVEMENT MARKING**

LOCATION	IL 70	STA. 116+30 - 457+88	TOTAL	4467
REMARKS	FOOT	Yellow		526
		White		4993

**70300150 SHORT TERM PAVEMENT MARKING REMOVAL**

LOCATION	IL 70	STA. 116+30 - 457+88	TOTAL	1665
REMARKS	SQ FT	Short Term Pavement Markings		1665

**78000100 THERMOPLASTIC PAVEMENT MARKING - LETTERS AND SYMBOLS**

LOCATION	IL 70	STA. 262+54	TOTAL	15.6
REMARKS	SQ FT	(Task Bridge Road) LT-Turn Arrow		15.6
		(Task Bridge Road) LT-Turn Arrow		15.6
		(Task Bridge Road) LT-Turn Arrow		15.6

**78000200 THERMOPLASTIC PAVEMENT MARKING - LINE 4"**

LOCATION	IL 70	STA. 256+71 - 261+82	TOTAL	2044.0
REMARKS	FOOT	Double Yellow Median		3436.0
		Double Yellow Median		5480

**78000500 THERMOPLASTIC PAVEMENT MARKING - LINE 8"**

LOCATION	IL 70	STA. 260+00 - 261+15	TOTAL	115.0
REMARKS	FOOT	White RT Turn Lane		115.0
		White LT Turn Lane		211.0
		White Island (As Needed)		65.0
		White Island (As Needed)		52.0
		White Island (As Needed)		52.0
		White Island (As Needed)		52.0
		White Island (As Needed)		83.0
		White RT Turn Lane		150.0
		White Island (As Needed)		71.0
		White RT Turn Lane		150.0
		White RT Turn Lane		150.0

(Task Bridge Rd)  
 (Task Bridge Rd)  
 (Task Bridge Rd)  
 (Judd Rd)  
 (Judd Rd)  
 (Leech Rd)  
 (Leech Rd)  
 (Moate Rd)  
 (Moate Rd)

**SCHEDULE OF QUANTITIES**

**78000600 THERMOPLASTIC PAVEMENT MARKING - LINE 12"**

LOCATION	FOOT	REMARKS
IL 70		
STA. 256+71 - 261+82	141.0	Yellow Diagonal
STA. 262+50 - 271+09	225.0	Yellow Diagonal
Task Bridge Road	71.0	White Diagonal (As Needed)
STA. 284+27 - 284+66	28.0	White Diagonal (As Needed)
STA. 285+32 - 285+59	28.0	White Diagonal (As Needed)
STA. 339+05 - 339+61	28.0	White Diagonal (As Needed)
STA. 419+94 - 420+45	28.0	White Diagonal (As Needed)
<b>TOTAL</b>	<b>549</b>	

(Judd Rd)  
(Judd Rd)  
(Leach Rd)  
(Moate Rd)

**78001110 PAINT PAVEMENT MARKING - LINE 4 INCH**

LOCATION	FOOT	REMARKS
IL 70		
(YELLOW) 2 Applications		
STA. 116+30 - 123+30	350	Skip dash
STA. 123+30 - 132+80	2375	Skip/Solid
STA. 132+80 - 146+53	5492	Double Yellow
STA. 146+53 - 159+73	3300	Solid/Skip
STA. 159+73 - 165+54	291	Skip dash
STA. 165+54 - 175+04	2375	Skip/Solid
STA. 175+04 - 187+71	5068	Double Yellow
STA. 187+71 - 198+37	2665	Solid/Skip
STA. 198+37 - 208+83	523	Skip dash
STA. 208+83 - 219+39	2640	Skip/Solid
STA. 219+39 - 224+15	1904	Double Yellow
STA. 224+15 - 235+23	2770	Solid/Skip
STA. 235+23 - 246+34	556	Skip dash
STA. 246+34 - 256+71	4148	Double Yellow
STA. 271+09 - 279+66	3428	Double Yellow
STA. 279+66 - 289+00	2335	Solid/Skip
STA. 289+00 - 292+00	150	Skip dash
STA. 292+00 - 301+34	2335	Skip/Solid
STA. 301+34 - 329+21	11148	Double Yellow
STA. 329+21 - 340+47	2855	Solid/Skip
STA. 340+47 - 346+15	294	Skip dash
STA. 346+15 - 357+95	2950	Skip/Solid
STA. 357+95 - 372+60	5860	Double Yellow
STA. 372+60 - 383+56	2740	Solid/Skip
STA. 383+56 - 409+93	1319	Skip dash
STA. 409+93 - 419+45	2380	Skip/Solid
STA. 419+45 - 420+45	400	Double Yellow
STA. 420+45 - 447+85	10760	Double Yellow
STA. 447+85 - 456+50	2163	Solid/Skip
STA. 456+50 - 457+88	69	Skip Dash
(WHITE) 2 Applications		
STA. 117+50 - 212+21	18942	Edgeline RT
STA. 213+25 - 455+06	48362	Edgeline RT
STA. 455+06 - 457+88	564	Edgeline RT
STA. 117+50 - 159+90	8480	Edgeline LT
STA. 160+80 - 211+86	10212	Edgeline LT
STA. 213+31 - 457+88	48914	Edgeline LT
Task Bridge Road (RT)	0	Edgeline
Judd Road (LT)	0	Edgeline
Judd Road (RT)	0	Edgeline
Leach Road (LT)	0	Edgeline
Moate Road (LT)	0	Edgeline
<b>TOTAL</b>	<b>221107</b>	

**SCHEDULE OF QUANTITIES**

FAS 55 (IL 70)  
 Section 102RS-3  
 Winnebago County  
 Contract #64L37  
 Sheets 12 of 50

<b>78100100 RAISED REFLECTIVE PAVEMENT MARKERS</b>			
LOCATION	IL 70		
STA. 116+30 - 256+71	179		
STA. 256+71 - 261+82	31		
STA. 262+50 - 271+09	55		
STA. 271+09 - 420+45	190		
STA. 420+95 - 457+88	47		
STA. 260+00 - 261+15	7		
STA. 262+50 - 264+50	11		
STA. 340+04 - 341+54	9		
STA. 421+14 - 422+64	9		
<b>TOTAL</b>	<b>538</b>		
LOCATION	IL 70		
STA. 116+30 - 457+88	37689		
STA. 116+30 - 457+88	37689		
LOCATION	IL 70		
STA. 116+30 - 457+88	448		
STA. 116+30 - 457+88	448		
LOCATION	IL 70		
STA. 116+30 - 457+88	97132		
STA. 116+30 - 457+88	97132		
REMARKS	EXCLUDES ALL RT TURN LANES AND PAVED SHOULDERS		
LOCATION	FOOT		
STA. 116+30 - 457+88	11386		
STA. 116+30 - 457+88	11386		
REMARKS	LT & RT (AS NEEDED BY ENGINEER)		
<b>X0326219 BUMP REMOVAL</b>			
LOCATION	IL 70		
STA. 116+30 - 457+88	50		
STA. 116+30 - 457+88	50		
REMARKS	SB LANES		
	NB LANES		
<b>TOTAL</b>	<b>100</b>		
<b>X7810400 TEMPORARY RAISED REFLECTIVE PAVEMENT MARKER</b>			
LOCATION	EACH		
STA. 116+30 - 457+88	9675		
STA. 116+30 - 457+88	9675		
REMARKS	YELLOW		
	WHITE		
<b>TOTAL</b>	<b>9781</b>		



PROJECT BEGINS  
STA 116+30

PROPOSED CAPE SEAL

115+00



PROPOSED CAPE SEAL

120+00

FILE NAME = D:\Projects\Winnebago\64L37_IL70_Cape_Seal_From_IL_75_to_Pecatonica_River\01d_IL70_Project\02\0305-shr-plot.dgn	STATE OF ILLINOIS DEPARTMENT OF TRANSPORTATION	IL 70	F.A.S. RTE.	SECTION	COUNTY	TOTAL SHEETS	SHEET NO.
			55	102RS-3	WINNEBAGO	50	13
USER NAME = goffjl			FED. ROAD DIST. NO.		ILLINOIS FED. AID PROJECT		
PLOT DATE = 3/8/2016			CONTRACT NO. 64L37				



PROPOSED CAPE SEAL

125+00

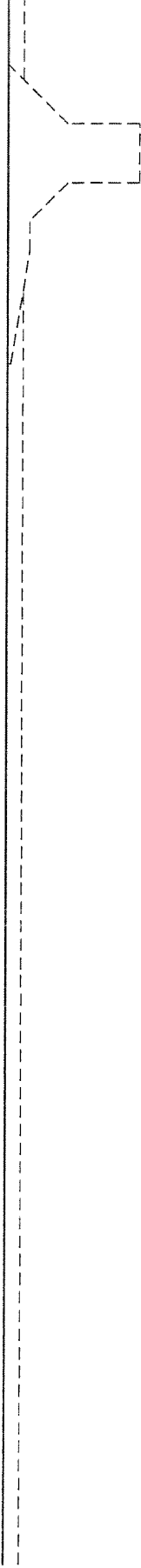

PROPOSED CAPE SEAL

130+00

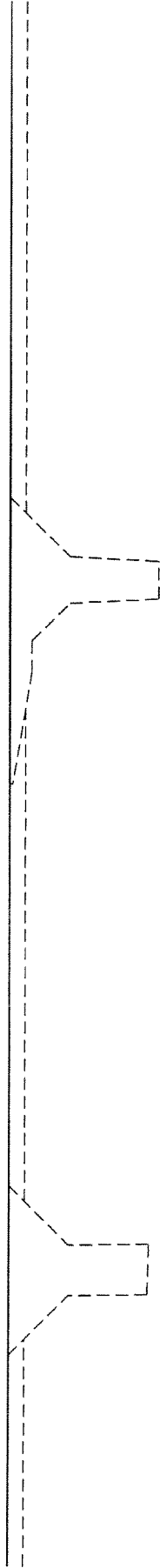

FILE NAME =		O:\Projects\Winnebago\64L37_IL70_Cape_Seal_From_IL_75_to_Peatonica_River\01d_IL70_Project\0210305-sht-pln.dgn		TOTAL SHEETS		50	
STATE OF ILLINOIS		DEPARTMENT OF TRANSPORTATION		COUNTY		WINNEBAGO	
IL 70		SECTION		F.A.S. RTE.		CONTRACT NO. 64L37	
		102RS-3		55		50 14	
		ILLINOIS		FED. ROAD DIST. NO.		FED. AID PROJECT	
USER NAME = goffj		PLOT DATE = 3/8/2016					



PROPOSED CAPE SEAL

135+00

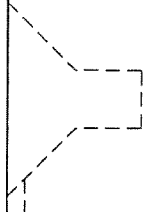

PROPOSED CAPE SEAL

140+00

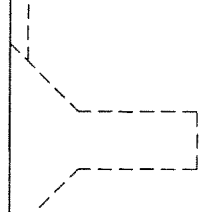

FILE NAME =		G:\Projects\Winnebago\64L37_IL70_Cape_Seal_From_IL_75_to_Peaton		ca_River\01d_IL70_Project\0210305-sht-pln.dgn		IL 70		F.A.S. RTE.		SECTION		COUNTY		TOTAL SHEETS	
STATE OF ILLINOIS		DEPARTMENT OF TRANSPORTATION		55		102RS-3		WINNEBAGO		50		15		CONTRACT NO. 64L37	
USER NAME = goffjl		PLOT DATE = 3/8/2016		ILLINOIS		FED. ROAD DIST. NO.		ILLINOIS		FED. AID PROJECT					





PROPOSED CAPE SEAL

145+00

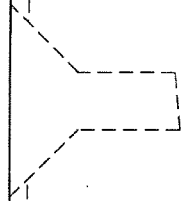

PROPOSED CAPE SEAL

150+00

FILE NAME =		D:\Projects\Winnebago\64L37-IL70-Cape-Seal.From-IL-75.to-Peaton		ca.River\Old IL70_Project\D210305-sht-pln.dgn		STATE OF ILLINOIS		DEPARTMENT OF TRANSPORTATION		IL 70		F.A.S. RTE.		SECTION		COUNTY		TOTAL SHEETS	
USER NAME = goff,jl		D:\Projects\Winnebago\64L37-IL70-Cape-Seal.From-IL-75.to-Peaton		ca.River\Old IL70_Project\D210305-sht-pln.dgn		STATE OF ILLINOIS		DEPARTMENT OF TRANSPORTATION		IL 70		55		102RS-3		WINNEBAGO		50	
PLOT DATE = 3/8/2016		D:\Projects\Winnebago\64L37-IL70-Cape-Seal.From-IL-75.to-Peaton		ca.River\Old IL70_Project\D210305-sht-pln.dgn		STATE OF ILLINOIS		DEPARTMENT OF TRANSPORTATION		IL 70		55		102RS-3		WINNEBAGO		50	
																		CONTRACT NO. 64L37	
																		FED. ROAD DIST. NO. ILLINOIS FED. AID PROJECT	

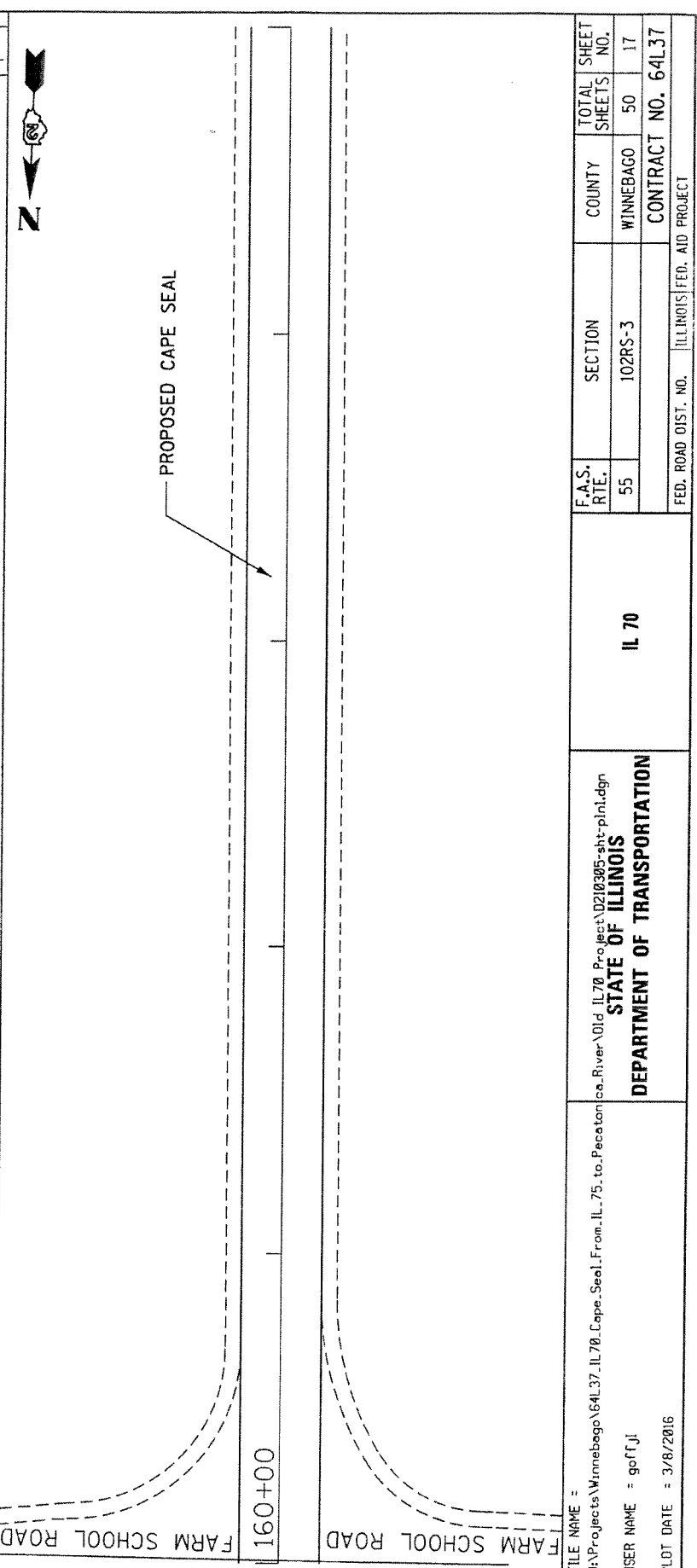
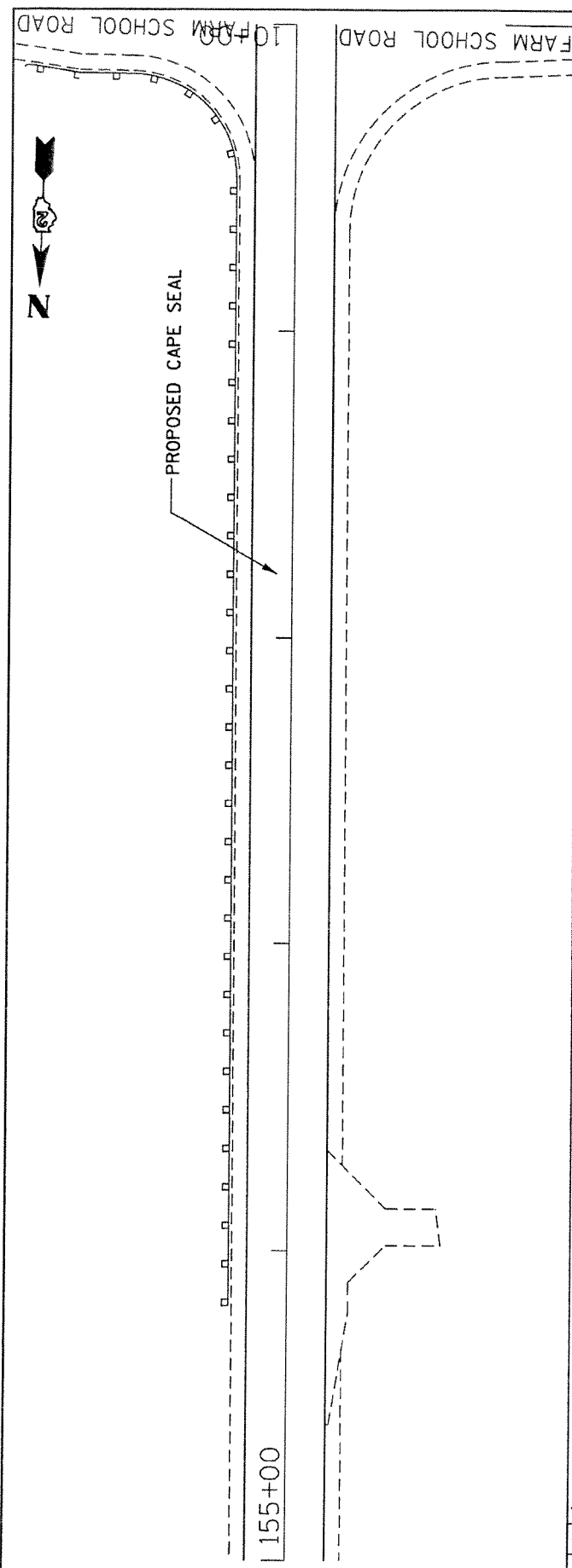

FILE NAME = D:\Projects\Winnebago\64L37-IL70.Cape_Seal_From_IL_75_to_Pecatonica.River\01d_IL70_Project\210305-shr-pln1.dgn		TOTAL SHEETS 50	
STATE OF ILLINOIS DEPARTMENT OF TRANSPORTATION		COUNTY WINNEBAGO	SHEET NO. 17
IL 70		SECTION 102RS-3	CONTRACT NO. 64L37
F.A.S. RTE. 55		FED. ROAD DIST. NO. ILLINOIS FED. AID PROJECT	
USER NAME = g9ffj		PLOT DATE = 3/8/2016	

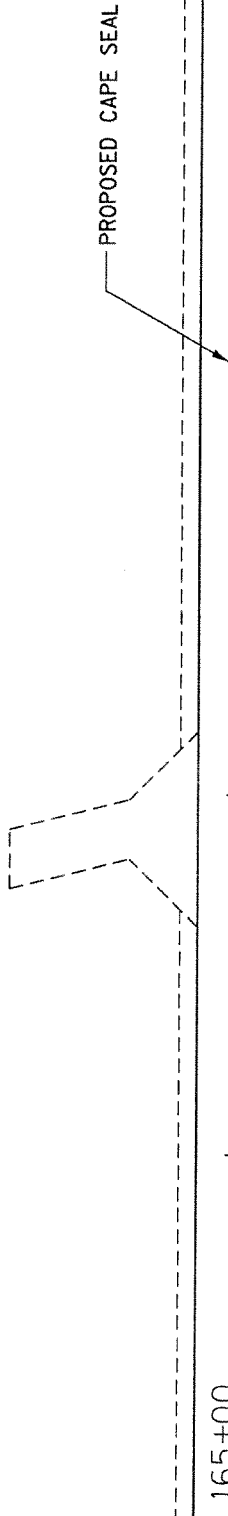

165+00

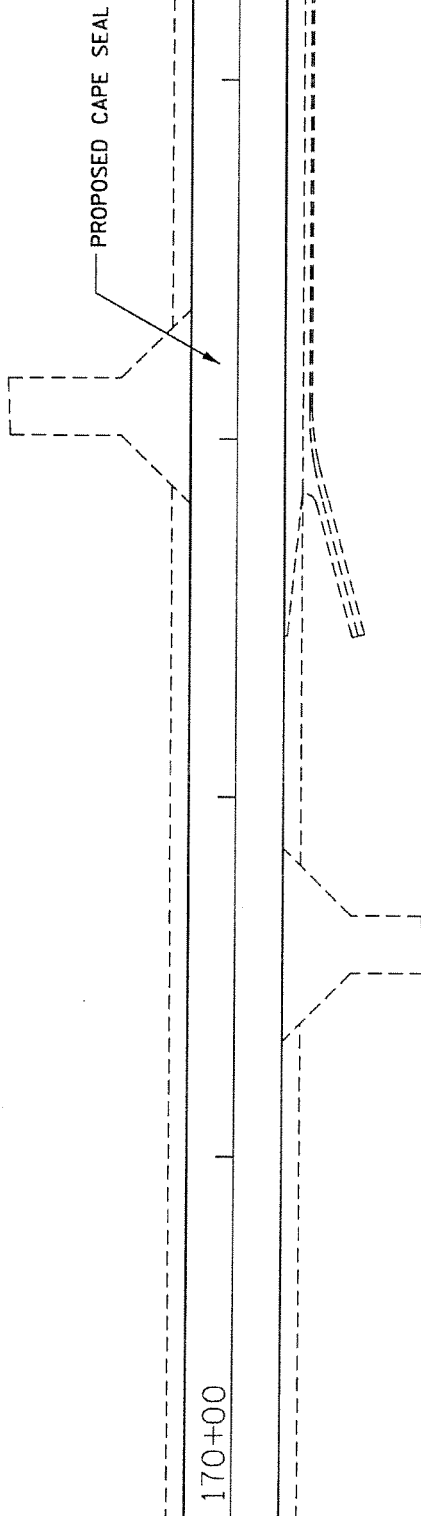

170+00

FILE NAME = D:\Projects\Winnebago\64L37_IL70_Cape_Seal_From_IL_75_to_Peestonca_River\01d_IL70_Project\0210305-shl-pln.dgn	STATE OF ILLINOIS DEPARTMENT OF TRANSPORTATION	IL 70	F.A.S. RTE.	SECTION	COUNTY	TOTAL SHEETS	SHEET NO.
			55	102RS-3	WINNEBAGO	50	18
USER NAME = goff,ji			FED. ROAD DIST. NO.		ILLINOIS FED. AID PROJECT		
PLOT DATE = 3/8/2016			CONTRACT NO. 64L37				



PROPOSED CAPE SEAL

175+00

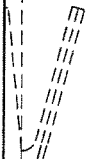

PROPOSED CAPE SEAL

180+00

FILE NAME =		0:\Projects\Winnebago\64L37_IL70_Cape_Seal_From_IL75_to_Peabody\ca.River\01d_IL70_Project\0210305-sht-pln.dgn		IL 70		TOTAL SHEETS	
USER NAME = goffjl		STATE OF ILLINOIS		DEPARTMENT OF TRANSPORTATION		COUNTY	
PLOT DATE = 3/8/2016		DEPARTMENT OF TRANSPORTATION		IL 70		WINNEBAGO	
		DEPARTMENT OF TRANSPORTATION		IL 70		CONTRACT NO. 64L37	
		DEPARTMENT OF TRANSPORTATION		IL 70		FED. ROAD DIST. NO. ILLINOIS FED. AID PROJECT	
		DEPARTMENT OF TRANSPORTATION		IL 70		F.A.S. RTE. 55	
		DEPARTMENT OF TRANSPORTATION		IL 70		SECTION 102RS-3	
		DEPARTMENT OF TRANSPORTATION		IL 70		CONTRACT NO. 64L37	

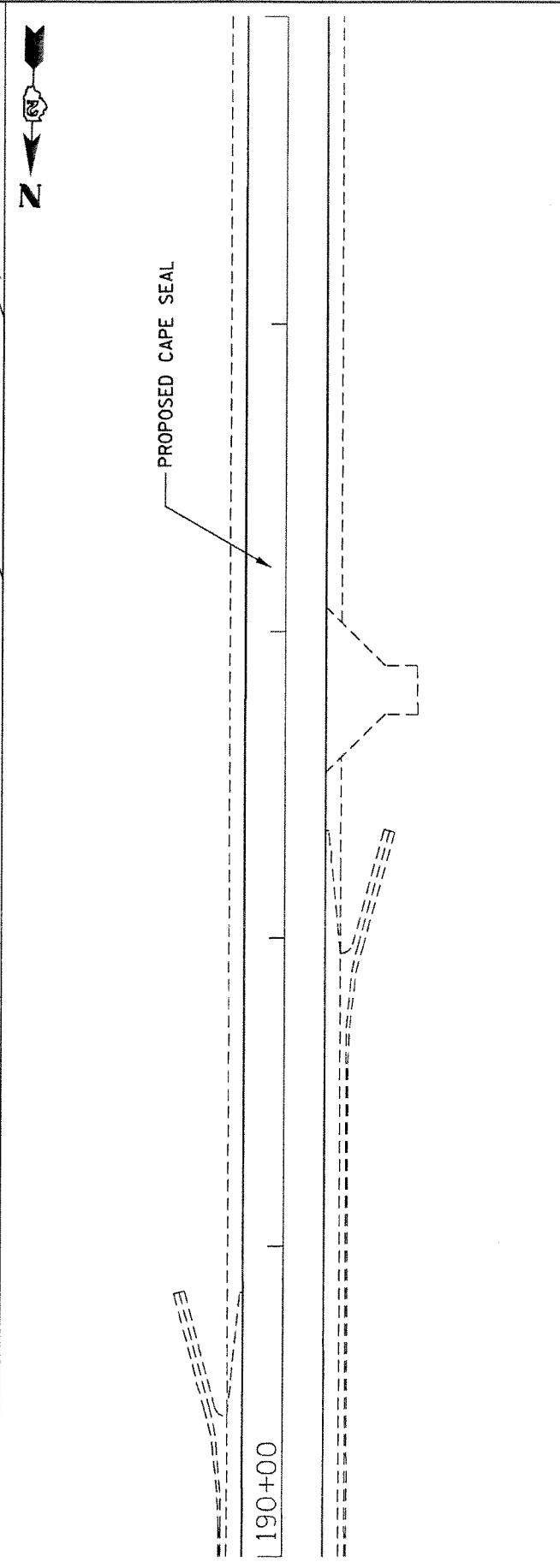
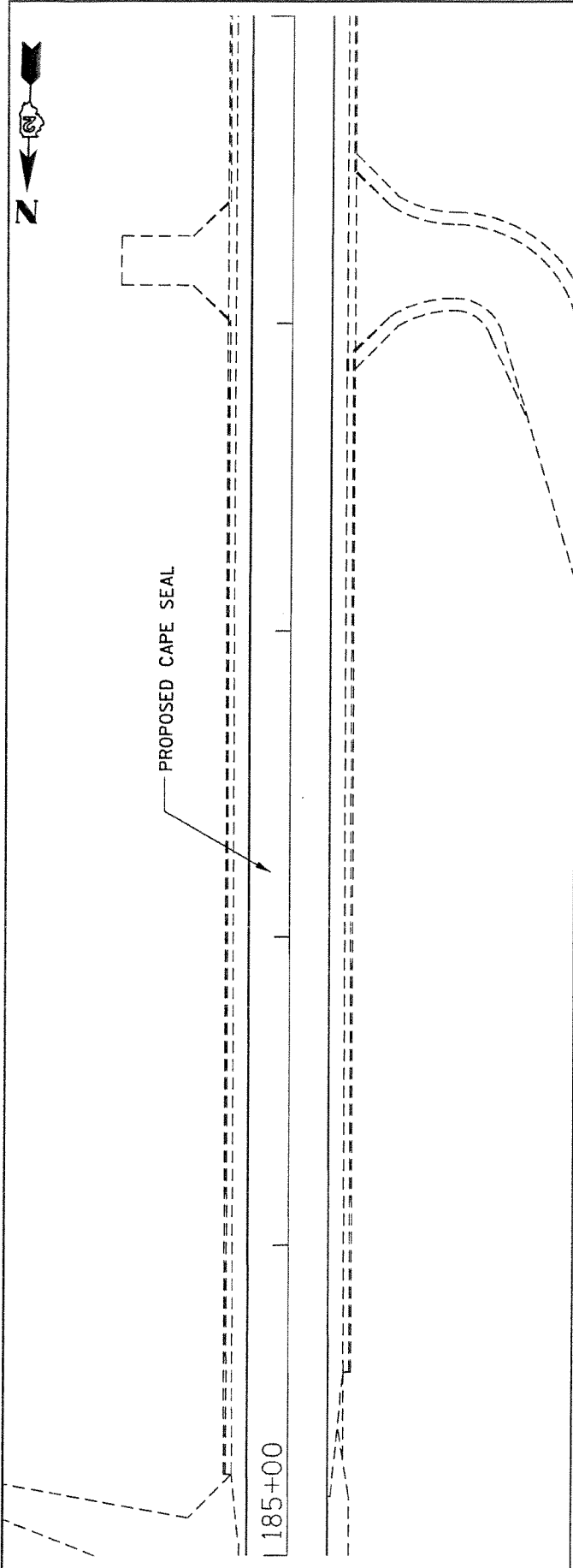

FILE NAME =		O:\Projects\Winnebago\64L37_IL70_Cape_Seal_From_IL_75_to_Pecatonica_River\01d_IL70_Project\0210305-sht-pln.dgn		TOTAL SHEETS		50	
USER NAME = goffjl		STATE OF ILLINOIS		COUNTY		WINNEBAGO	
PLOT DATE = 3/8/2016		DEPARTMENT OF TRANSPORTATION		SECTION		102RS-3	
		IL 70		F.A.S. RTE.		55	
				FED. ROAD DIST. NO.		ILLINOIS FED. AID PROJECT	
				CONTRACT NO.		64L37	



PROPOSED CAPE SEAL

195+00



PROPOSED CAPE SEAL

200+00

FILE NAME = D:\Projects\Winnebago\64L37.IL70.Cape.Seal.From.IL.75.to.Peaton\co.River\01d_IL70_Project\0210305-shr-pln.dgn		TOTAL SHEETS		50	
STATE OF ILLINOIS DEPARTMENT OF TRANSPORTATION		COUNTY		WINNEBAGO	
IL 70		SECTION		102RS-3	
F.A.S. RTE.		55		CONTRACT NO. 64L37	
PLOT DATE = 3/8/2016		FED. ROAD DIST. NO.		ILLINOIS FED. AID PROJECT	



PROPOSED CAPE SEAL

205+00

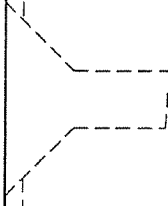

PROPOSED CAPE SEAL

210+00

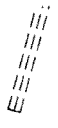

10+00 CAMPBELL ROAD

CAMPBELL ROAD

FILE NAME = G:\Projects\Winnebago\64L37_IL70_Cape_Seal_From_IL_75_to_Peaton\ea.River\01d_IL70_Project\0210305-sht-phn1.dgn		IL 70		F.A.S. RTE.	SECTION	COUNTY	TOTAL SHEETS	SHEET NO.
STATE OF ILLINOIS DEPARTMENT OF TRANSPORTATION		55		102RS-3	WINNEBAGO	50	22	
USER NAME = goffjl		FED. ROAD DIST. NO.		ILLINOIS FED. AID PROJECT		CONTRACT NO. 64L37		
PLOT DATE = 3/8/2016								



PROPOSED CAPE SEAL

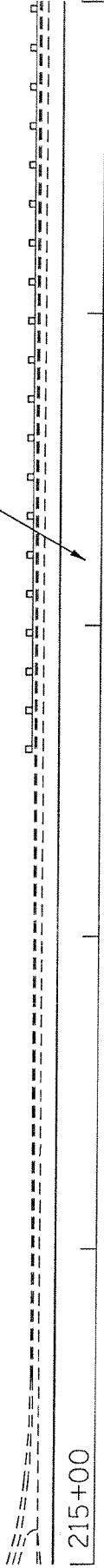

215+00



PROPOSED CAPE SEAL



220+00

FILE NAME = D:\Projects\Winnebago\64L37_IL70_Cape_Seal_From_IL_75_to_Pecatonica_River\01d_IL70_Project\02\0305-sht-pln.dgn		TOTAL SHEETS		COUNTY	
STATE OF ILLINOIS		50		WINNEBAGO	
DEPARTMENT OF TRANSPORTATION		50		CONTRACT NO. 64L37	
USER NAME = goffj		SECTION		ILLINOIS	
PLOT DATE = 3/8/2016		102RS-3		FED. ROAD DIST. NO.	
		IL 70		FED. AID PROJECT	
		F.A.S. RTE. 55			





PROPOSED CAPE SEAL

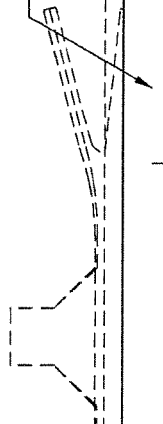

225+00



PROPOSED CAPE SEAL

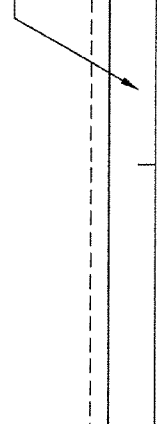

230+00

FILE NAME =		D:\Projects\Winnebago\64L37_IL70_Cape_Seal_From_IL75_to_Peatonico_River\01d_IL70_Project\210305-sht-pln1.dgn		TOTAL SHEETS		50	
USER NAME = goffjl		STATE OF ILLINOIS		COUNTY		WINNEBAGO	
PLOT DATE = 3/8/2016		DEPARTMENT OF TRANSPORTATION		SECTION		102RS-3	
		IL 70		F.A.S. RTE.		55	
				FED. ROAD DIST. NO.		ILLINOIS FED. AID PROJECT	
				CONTRACT NO.		64L37	



PROPOSED CAPE SEAL

235+00



PROPOSED CAPE SEAL

240+00

FILE NAME =		Q:\Projects\Winnebago\64L37_IL70_Cape_Seal_From_IL_75_to_Peaton\ca_River\01d_IL70_Project\0210305-sht-pln.lgdg		TOTAL SHEETS		50	
USER NAME = goff.jl		STATE OF ILLINOIS		COUNTY		WINNEBAGO	
PLOT DATE = 3/8/2016		DEPARTMENT OF TRANSPORTATION		SECTION		102RS-3	
		IL 70		F.A.S. RTE.		55	
				CONTRACT NO.		64L37	
				FED. ROAD DIST. NO.		ILLINOIS FED. AID PROJECT	



PROPOSED CAPE SEAL

245+00



PROPOSED CAPE SEAL

250+00

FILE NAME = Q:\Projects\Winnebago\64L37_IL70_Cape_Seal_From_IL_75_to_Pecatonico_River\01d_IL70_Projects\AD210305-sh-t-pl.mxd		TOTAL SHEETS 50		SHEET NO. 26	
USER NAME = goff.jl		COUNTY WINNEBAGO		CONTRACT NO. 64L37	
PLOT DATE = 3/8/2016		SECTION 102RS-3		FED. ROAD DIST. NO. ILLINOIS FED. AID PROJECT	
Q:\Projects\Winnebago\64L37_IL70_Cape_Seal_From_IL_75_to_Pecatonico_River\01d_IL70_Projects\AD210305-sh-t-pl.mxd		IL 70		STATE OF ILLINOIS DEPARTMENT OF TRANSPORTATION	
F.A.S. RTE. 55		SECTION 102RS-3		FED. ROAD DIST. NO. ILLINOIS FED. AID PROJECT	





THERMOPLASTIC PAVEMENT MARKING - LINE 4" (DOUBLE YELLOW)

THERMOPLASTIC PAVEMENT MARKING - LINE 12" (YELLOW)

STA 265+39.72  
8.00' LT

PROPOSED CAPE SEAL

20'

40'

12'

12'

**LEGEND**

- ◆ = TWO-WAY AMBER MARKER
- ◁ = ONE-WAY CRYSTAL MARKER



THERMOPLASTIC PAVEMENT MARKING - LINE 4" (DOUBLE YELLOW)

THERMOPLASTIC PAVEMENT MARKING - LINE 12" (YELLOW)

STA 271+09.00  
2.00' LT

PROPOSED CAPE SEAL

12'

12'

40'

**LEGEND**

- ◆ = TWO-WAY AMBER MARKER
- ◁ = ONE-WAY CRYSTAL MARKER

FILE NAME =		TOTAL SHEETS		SHEET NO.	
0:\Projects\Winnebago\64L37_IL70_Cape-Seal_From_IL_75_to_Peaton\ca.River\01d_IL70_Project\02\0305-sht-pln.lgn		50		28	
USER NAME = goff,jl		COUNTY		CONTRACT NO. 64L37	
PLOT DATE = 3/8/2016		WINNEBAGO		64L37	
STATE OF ILLINOIS DEPARTMENT OF TRANSPORTATION		SECTION		FED. ROAD DIST. NO.	
IL 70		102RS-3		ILLINOIS FED. AID PROJECT	
F.A.S. RTE. 55		102RS-3		ILLINOIS FED. AID PROJECT	

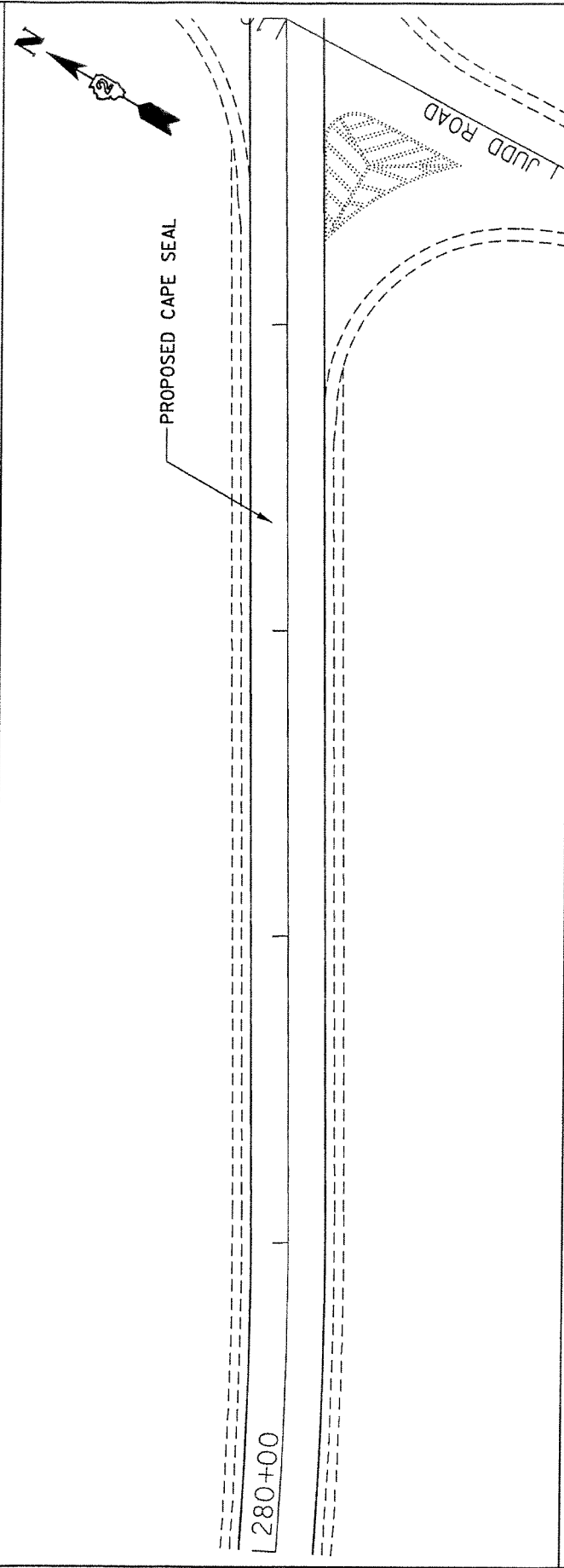
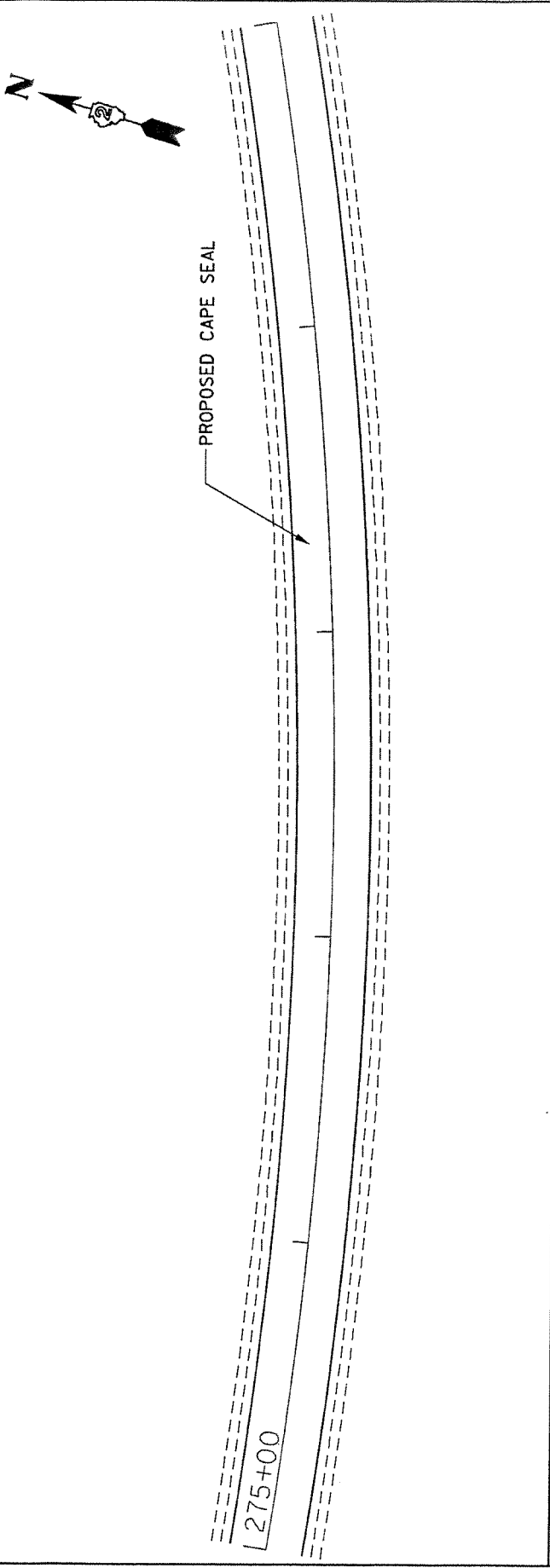

FILE NAME = G:\Projects\Winnebago\64L37_IL70_Cape_Seal_From_IL_75_to_Pecatonica_River\01\0218395-shr.pln.dgn		TOTAL SHEETS 50		SHEET NO. 29	
USER NAME = geftj		SECTION 102RS-3		COUNTY WINNEBAGO	
PLOT DATE = 3/8/2015		F.A.S. RTE. 55		CONTRACT NO. 64L37	
STATE OF ILLINOIS DEPARTMENT OF TRANSPORTATION		ILLINOIS FED. AID PROJECT		IL 70	

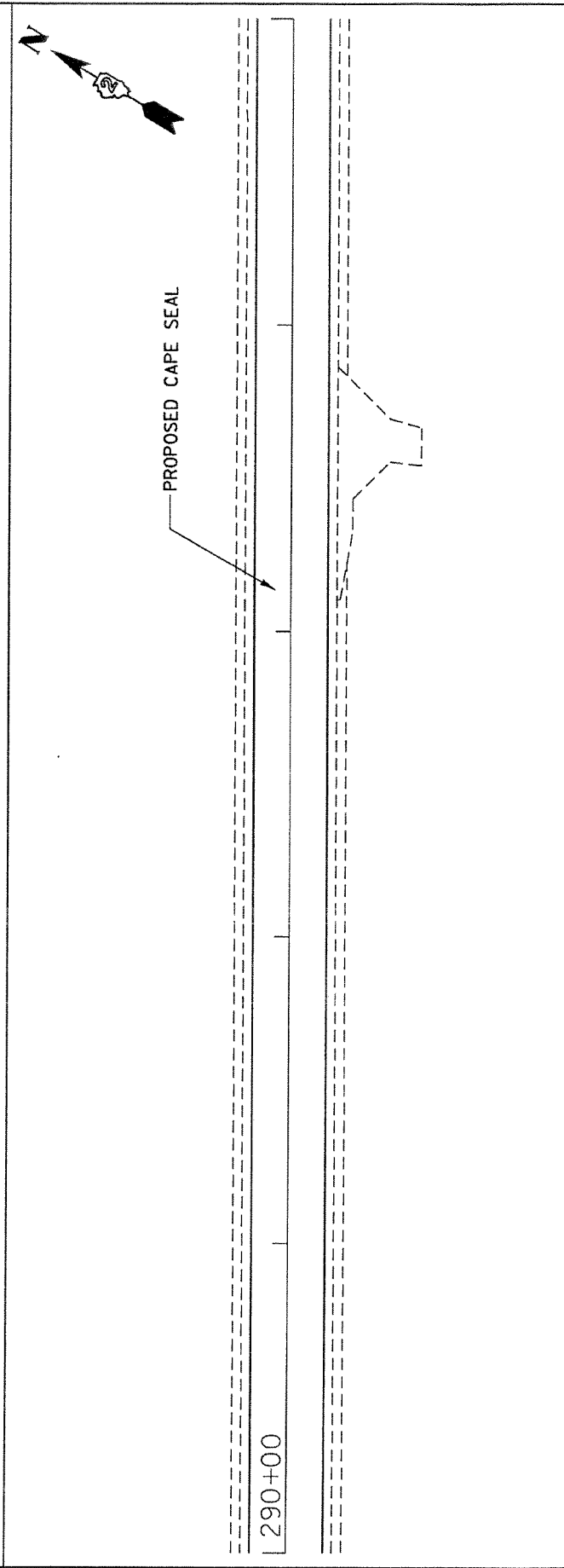
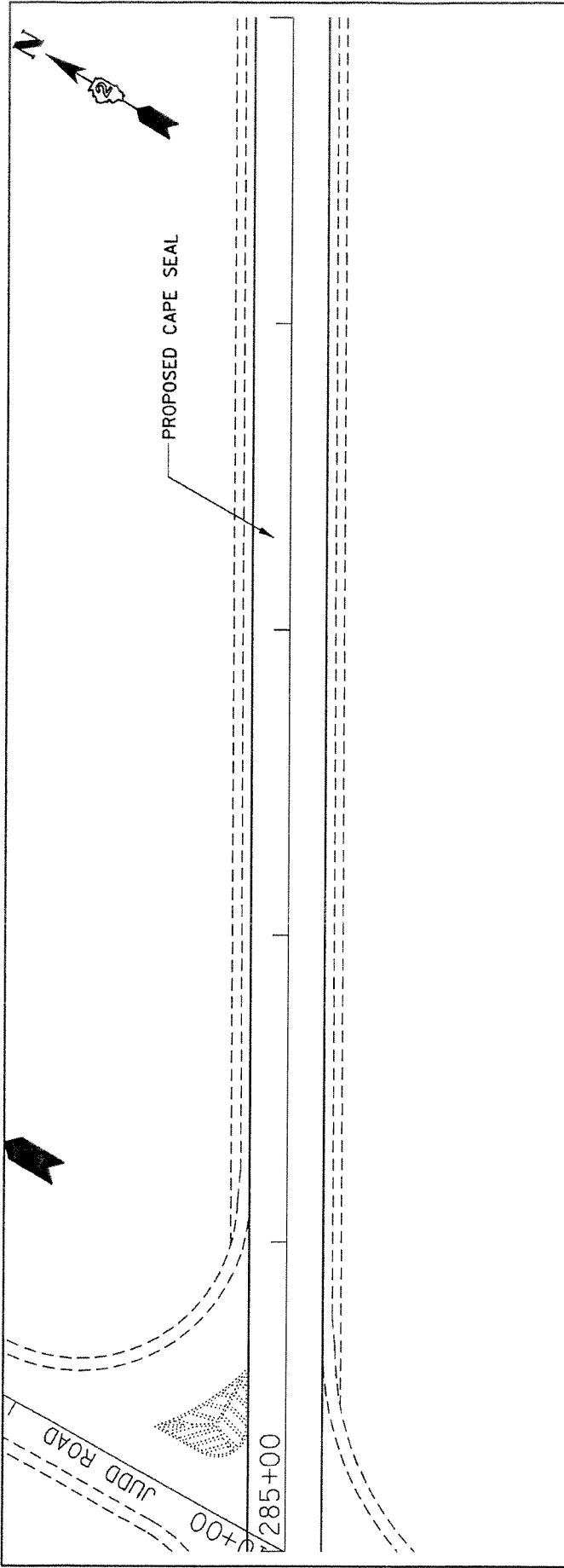

FILE NAME =		G:\Projects\Winnebago\64L37_IL70_Cape_Seal_From_IL_75_to_Pecatonica_River\01d_IL70_Project\02\0305-shr-pln.lcdgn		TOTAL SHEETS		50	
USER NAME = goff,jl		STATE OF ILLINOIS		COUNTY		WINNEBAGO	
PLOT DATE = 3/8/2016		DEPARTMENT OF TRANSPORTATION		SECTION		102RS-3	
		IL 70		F.A.S. RTE.		55	
				FED. ROAD DIST. NO.		ILLINOIS FED. AID PROJECT	
				CONTRACT NO.		64L37	

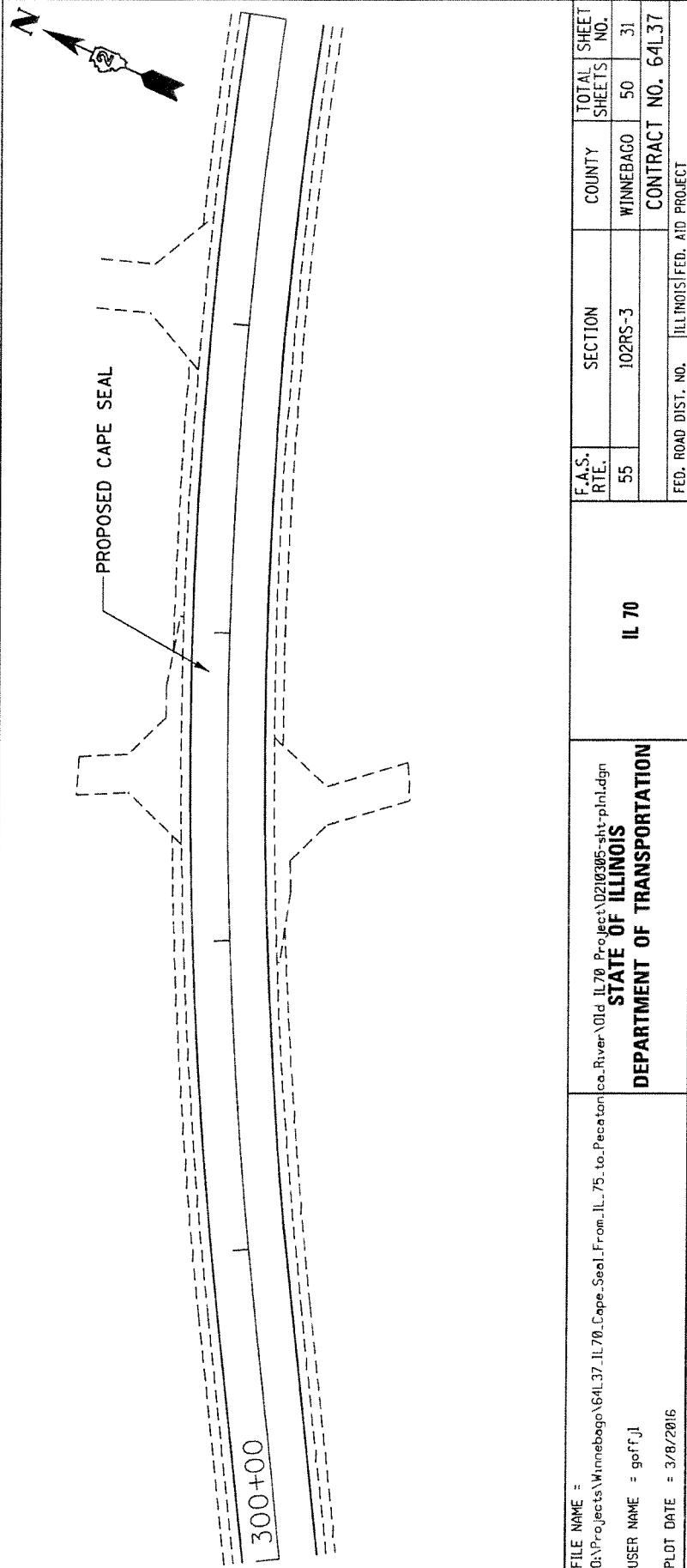
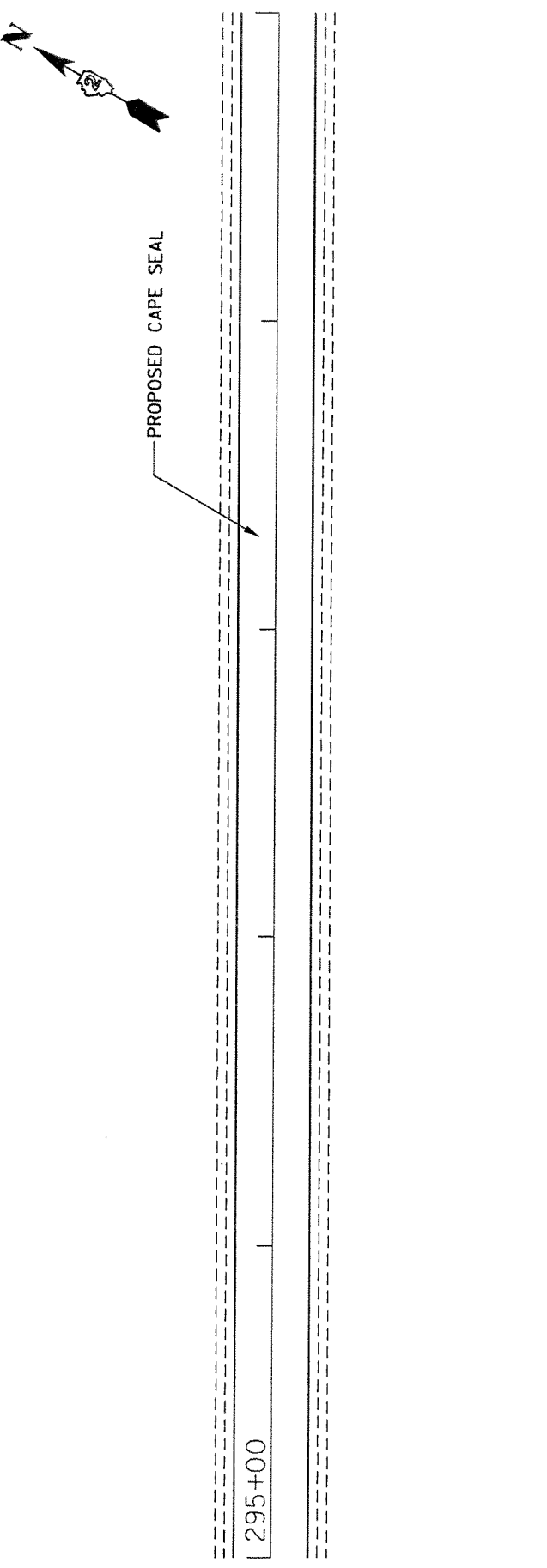

FILE NAME =		G:\Projects\Winnebago\64L37_IL70_Cape_Seal_From_IL_75_to_Peaton\loc_River\01d_IL70_Project\0210305-sht-p.lxdgn		COUNTY		TOTAL SHEETS	
USER NAME = goff,jl		STATE OF ILLINOIS		WINNEBAGO		50	
PLOT DATE = 3/8/2016		DEPARTMENT OF TRANSPORTATION		SECTION		31	
		IL 70		102RS-3		CONTRACT NO. 64L37	
				F.A.S. RTE. 55		FED. ROAD DIST. NO. ILLINOIS FED. AID PROJECT	



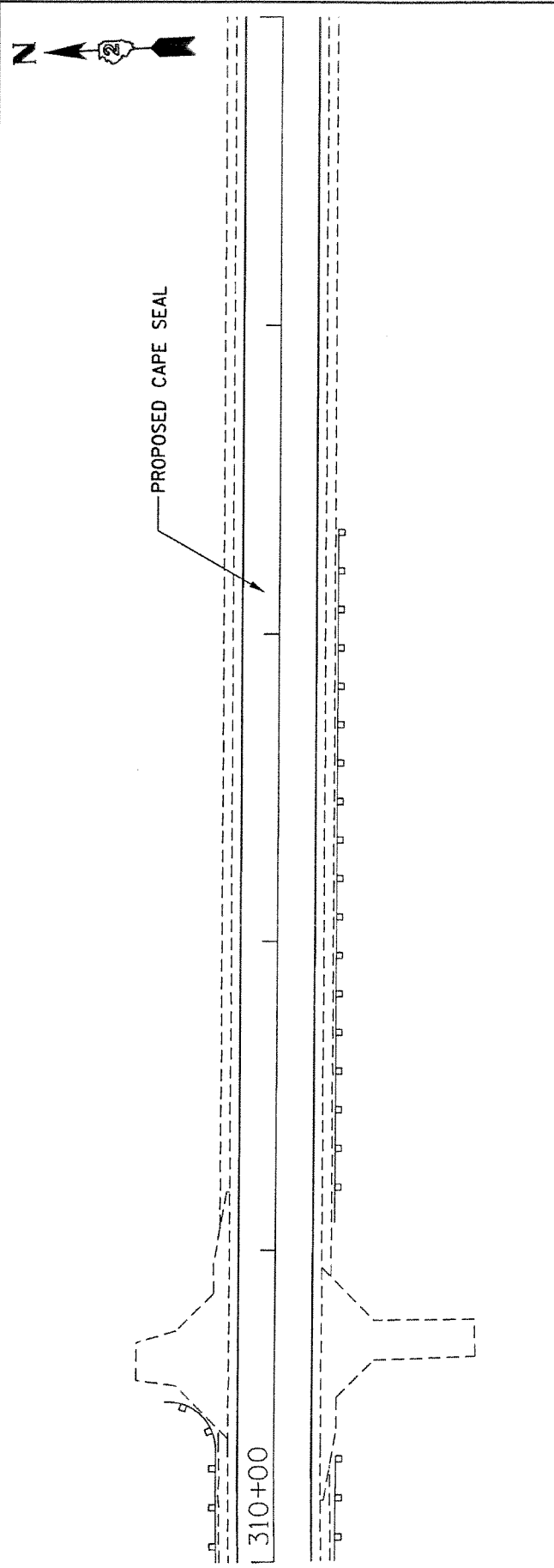
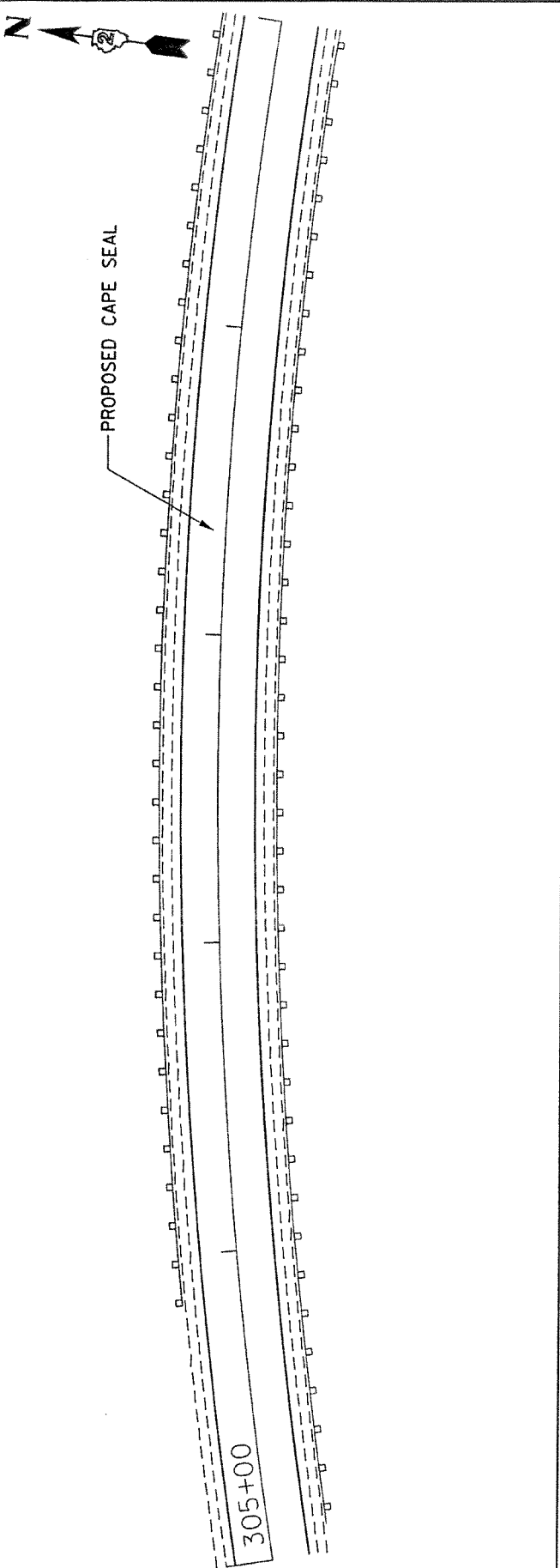

FILE NAME = 0:\Projects\Winnebago\64L37_IL70_Cape_Seal_From_IL_75_to_Pecatonico_River\01d_IL70_Project\02\0305-sht-pln.dgn		TOTAL SHEETS		CONTRACT NO. 64L37	
STATE OF ILLINOIS DEPARTMENT OF TRANSPORTATION		IL 70		50 32	
USER NAME = gof.t.j		SECTION		COUNTY	
PLOT DATE = 3/8/2016		102RS-3		WINNEBAGO	
F.A.S. RTE. 55		ILLINOIS		FED. AID PROJECT	
FED. ROAD DIST. NO.		SECTION		COUNTY	
		102RS-3		WINNEBAGO	

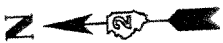

PROPOSED CAPE SEAL

315+00

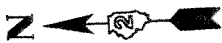

PROPOSED CAPE SEAL

320+00

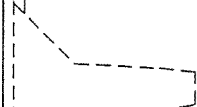

FILE NAME = O:\Projects\Winnebago\64L37_IL70_Cape_Seal_From_IL_75_to_Pecatonica\Job_River\01d_IL70_Project\0210305-shr-pint.dgn		TOTAL SHEETS		CONTRACT NO. 64L37	
STATE OF ILLINOIS DEPARTMENT OF TRANSPORTATION		COUNTY		WINNEBAGO	
IL 70		SECTION		102RS-3	
F.A.S. RTE.		55		50	
FED. ROAD DIST. NO.		ILLINOIS		FED. AID PROJECT	
USER NAME = gof.fjl		PLOT DATE = 3/8/2016			



PROPOSED CAPE SEAL

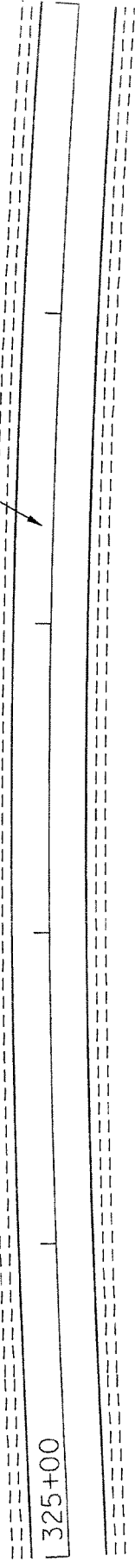

325+00



PROPOSED CAPE SEAL

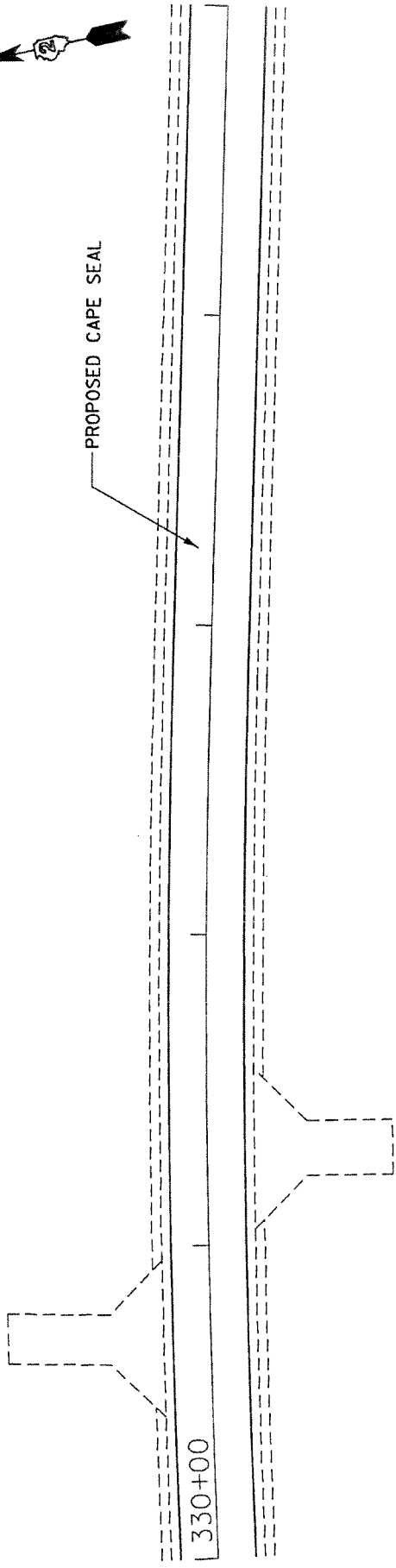

330+00

FILE NAME =

G:\Projects\Winnebago\64L37\_IL70\_Cape\_Seal\_From\_IL\_75\_to\_Peaton\Loc\_River\01d\_IL70\_Project\0210395-sht-pln1.dgn

USER NAME = goff,jl

PLOT DATE = 3/8/2016

STATE OF ILLINOIS  
DEPARTMENT OF TRANSPORTATION

IL 70

F.A.S. RTE.	SECTION	COUNTY	TOTAL SHEETS	SHEET NO.
55	102RS-3	WINNEBAGO	50	34
FED. ROAD DIST. NO.		ILLINOIS FED. AID PROJECT		
		CONTRACT NO. 64L37		

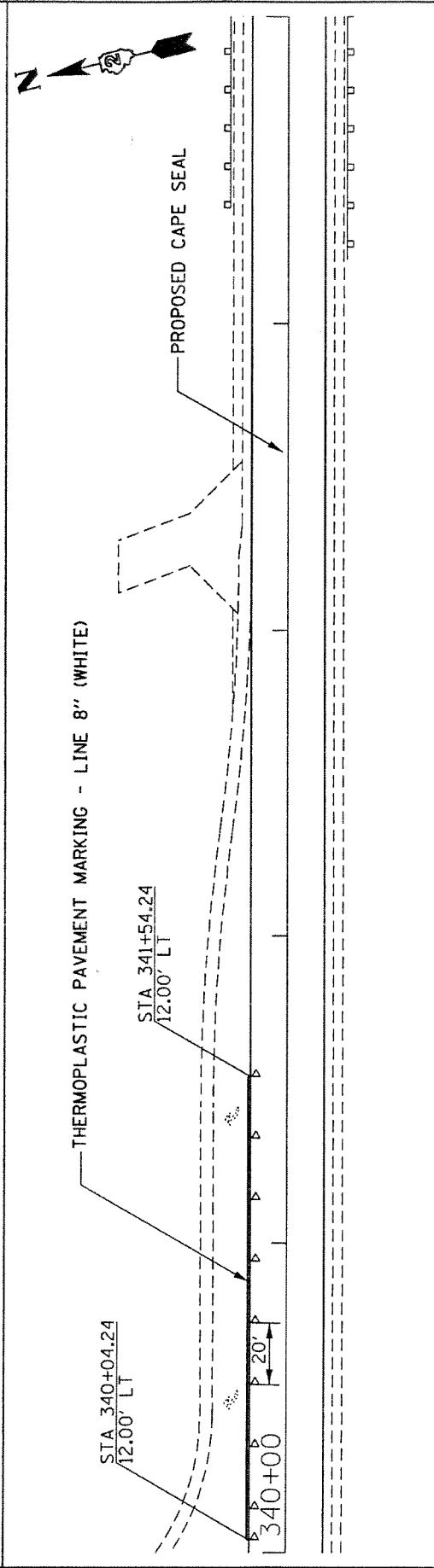
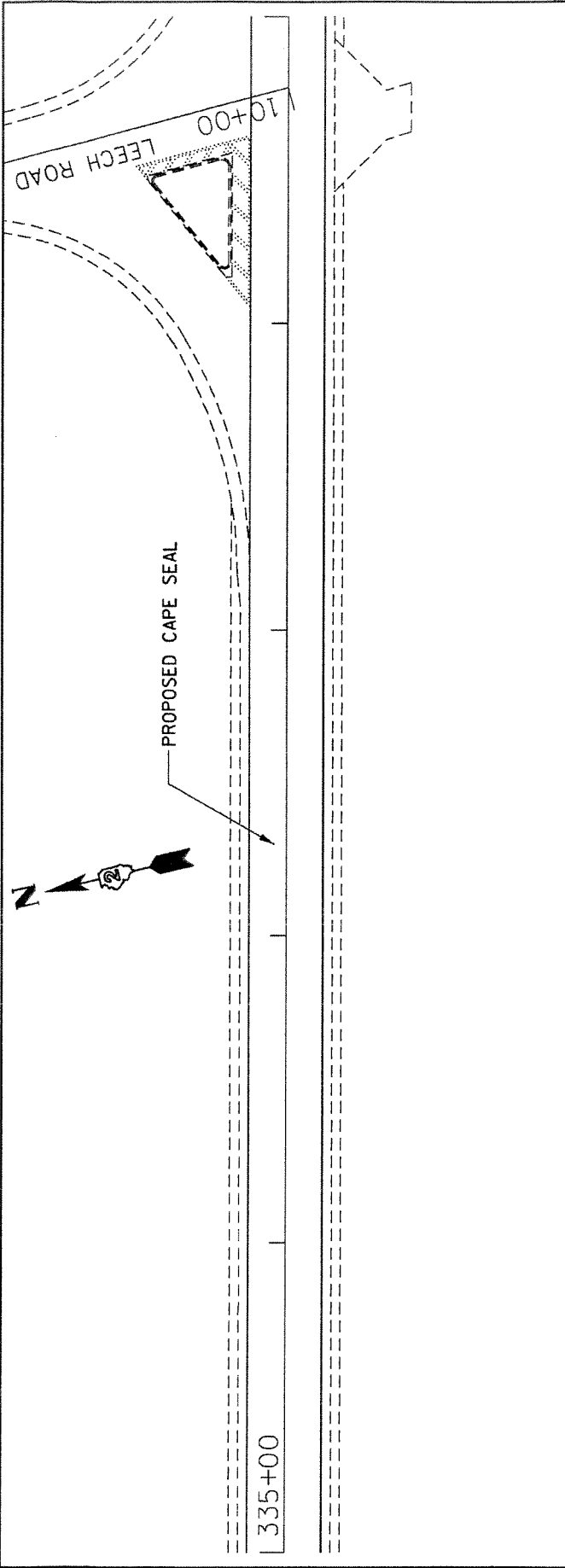

**LEGEND**

- ◆ = TWO-WAY AMBER MARKER
- ◁ = ONE-WAY CRYSTAL MARKER

FILE NAME =		F.A.S. RTE.		SECTION		COUNTY		TOTAL SHEETS		SHEET NO.	
D:\Projects\Winnebago\64L37_IL70_Cape_Seal_From_IL_75_to_Pecatonica_River\01d_IL70_Project\02\0305-sht-pln1.dgn		55		102RS-3		WINNEBAGO		50		35	
STATE OF ILLINOIS		ILLINOIS		FED. ROAD DIST. NO.		FED. AID PROJECT		CONTRACT NO.		64L37	
DEPARTMENT OF TRANSPORTATION		IL 70									
USER NAME = goff, j		PLOT DATE = 3/8/2016									

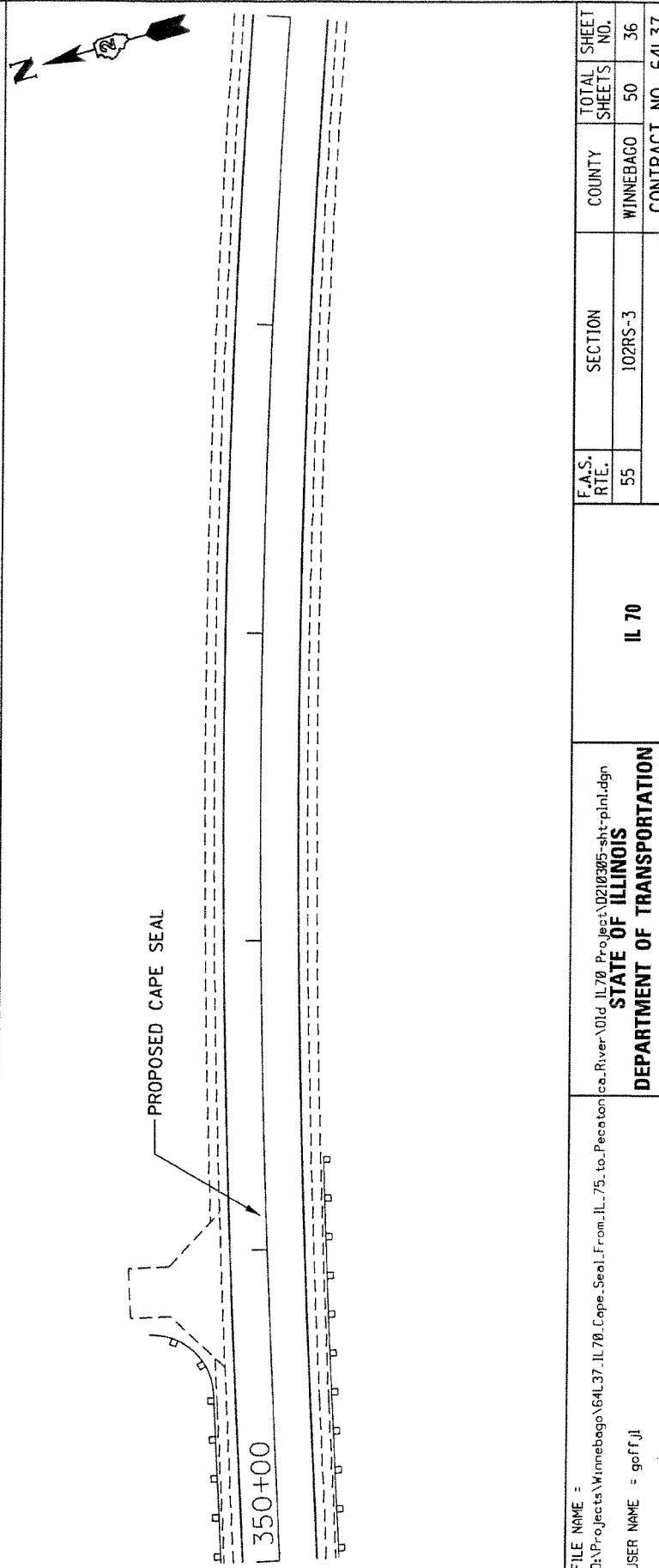
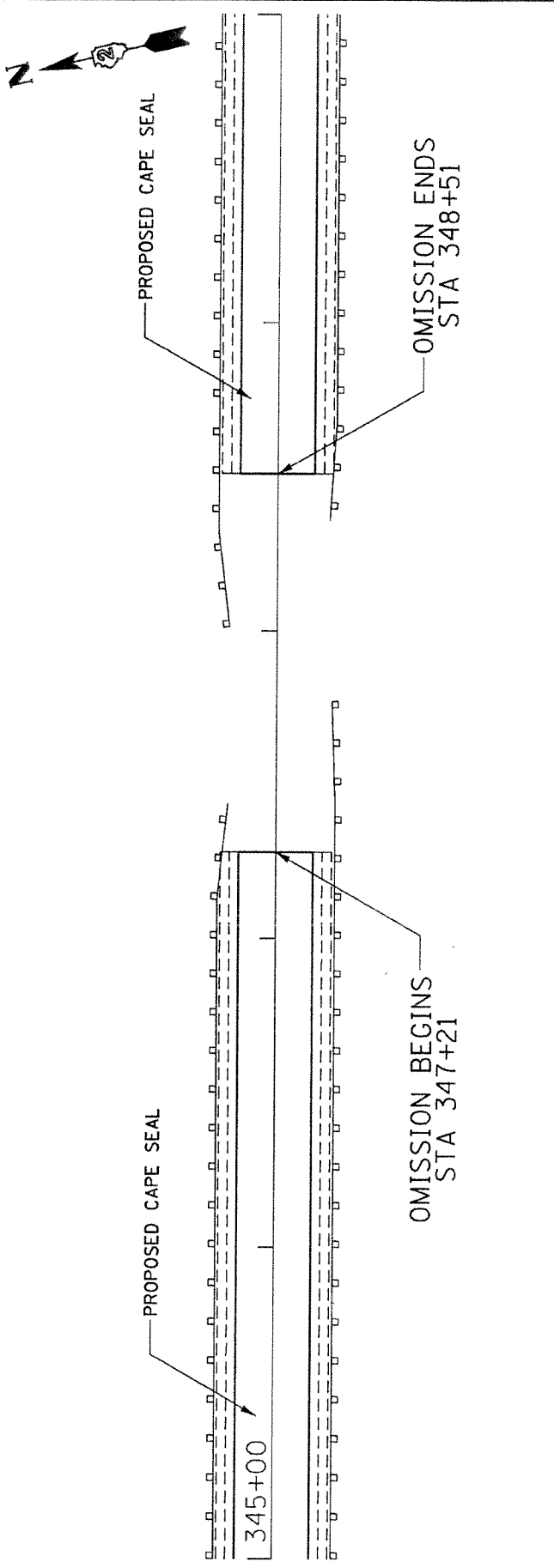

FILE NAME =		C:\Projects\Winnebago\64L37_IL70_Cape_Seal_From_IL_75_to_Pecatonica_River\01d_IL70_Projects\0210305-sh-t-pln.dgn		IL 70		TOTAL SHEETS	
USER NAME = goff,jl		STATE OF ILLINOIS		SECTION		COUNTY	
PLOT DATE = 3/8/2016		DEPARTMENT OF TRANSPORTATION		102RS-3		WINNEBAGO	
				F.A.S. RTE. 55		CONTRACT NO. 64L37	
				FED. ROAD DIST. NO.		ILLINOIS FED. AID PROJECT	

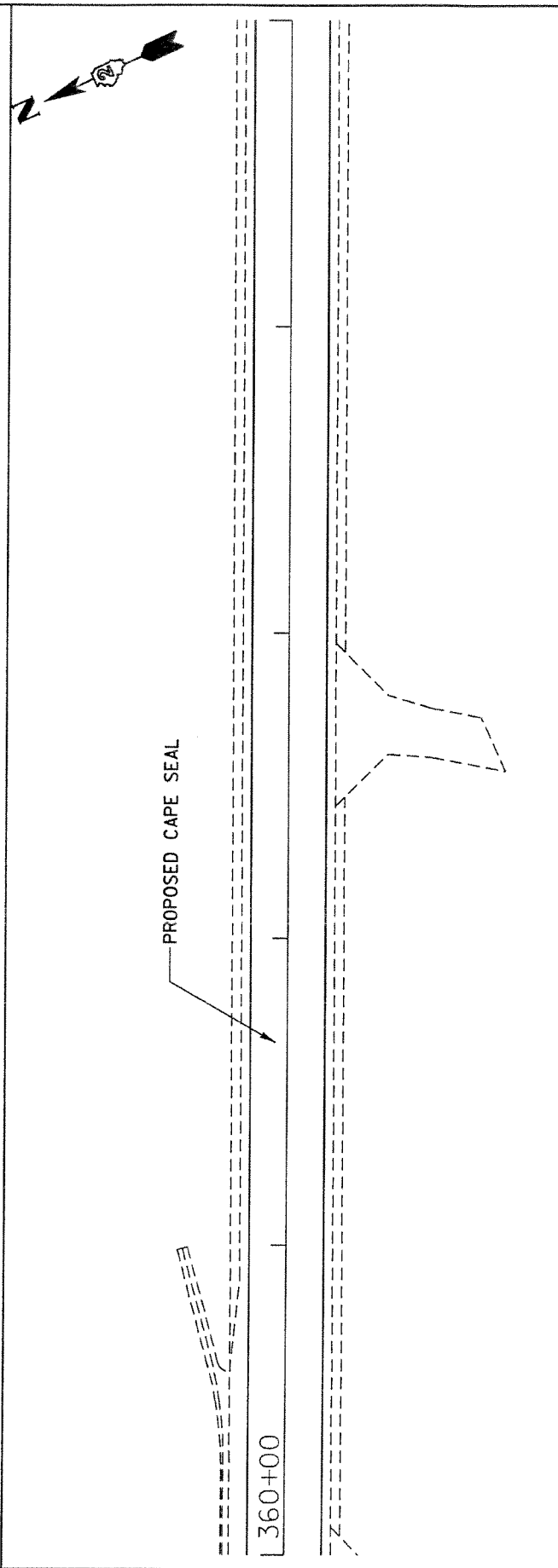
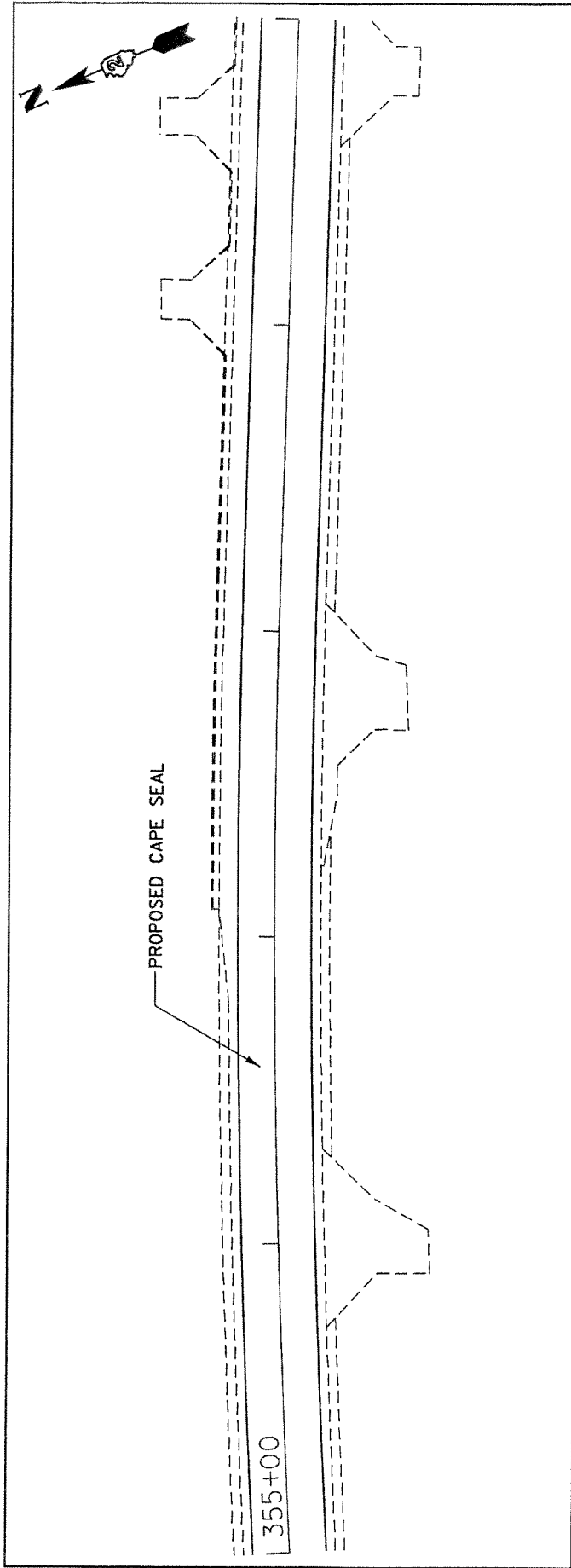

FILE NAME = 0:\Projects\Winnebago\64L37.IL70.Cape.Seal.From.IL.75.to.Pecatonica.River\01d_IL70_Project\02103085-sh-t-pl.mxd		TOTAL SHEETS 50		SHEET NO. 37	
USER NAME = gof,jl		COUNTY WINNEBAGO		CONTRACT NO. 64L37	
PLOT DATE = 3/8/2016		SECTION 102RS-3		FED. ROAD DIST. NO. ILLINOIS	
STATE OF ILLINOIS DEPARTMENT OF TRANSPORTATION		IL 70		FED. AID PROJECT	
F.A.S. RTE: 55		SECTION 102RS-3		FED. ROAD DIST. NO. ILLINOIS	



PROPOSED CAPE SEAL

365+00

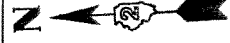

PROPOSED CAPE SEAL

370+00

FILE NAME = D:\Projects\Winnebago\64L37_IL70_Cape_Seal_From_IL_75_to_Pecatonica_River\01d_IL70_Project\02102015_sht-pln.dgn		TOTAL SHEETS 50		TOTAL SHEET NO. 38	
USER NAME = goff.j		COUNTY WINNEBAGO		CONTRACT NO. 64L37	
PLOT DATE = 3/8/2016		SECTION 102RS-3		FED. ROAD DIST. NO. ILLINOIS	
STATE OF ILLINOIS DEPARTMENT OF TRANSPORTATION		F.A.S. RTE. 55		FED. AID PROJECT	
IL 70					

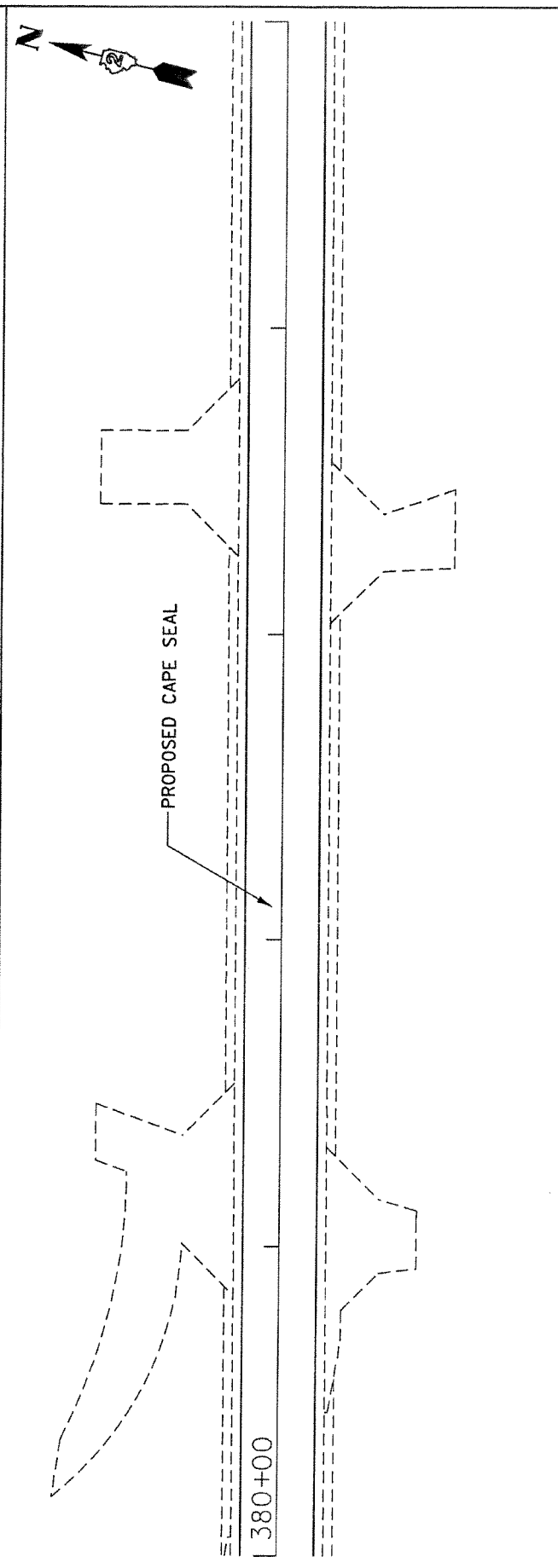
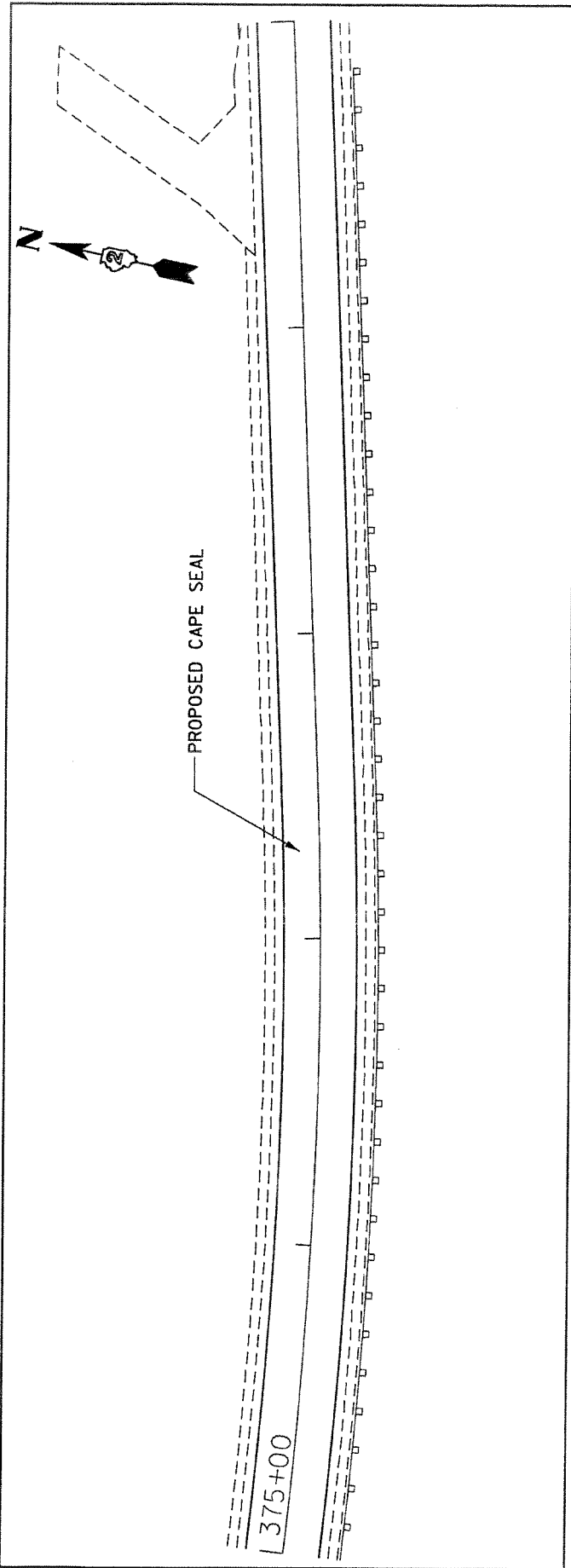

FILE NAME = Q:\Projects\Winnebago\64L37_IL70_Cape_Seal_From_IL_75_to_Peaton\ca.River\01d_IL70_P_oject\0210305-sh-t-pln1.dgn		TOTAL SHEETS		CONTRACT NO. 64L37	
STATE OF ILLINOIS DEPARTMENT OF TRANSPORTATION		IL 70		CONTRACT NO. 64L37	
USER NAME = gofj		SECTION		COUNTY	
PLOT DATE = 3/8/2016		102RS-3		WINNEBAGO	
		F.A.S. RTE.		ILLINOIS FED. AID PROJECT	
		55		50	
				39	



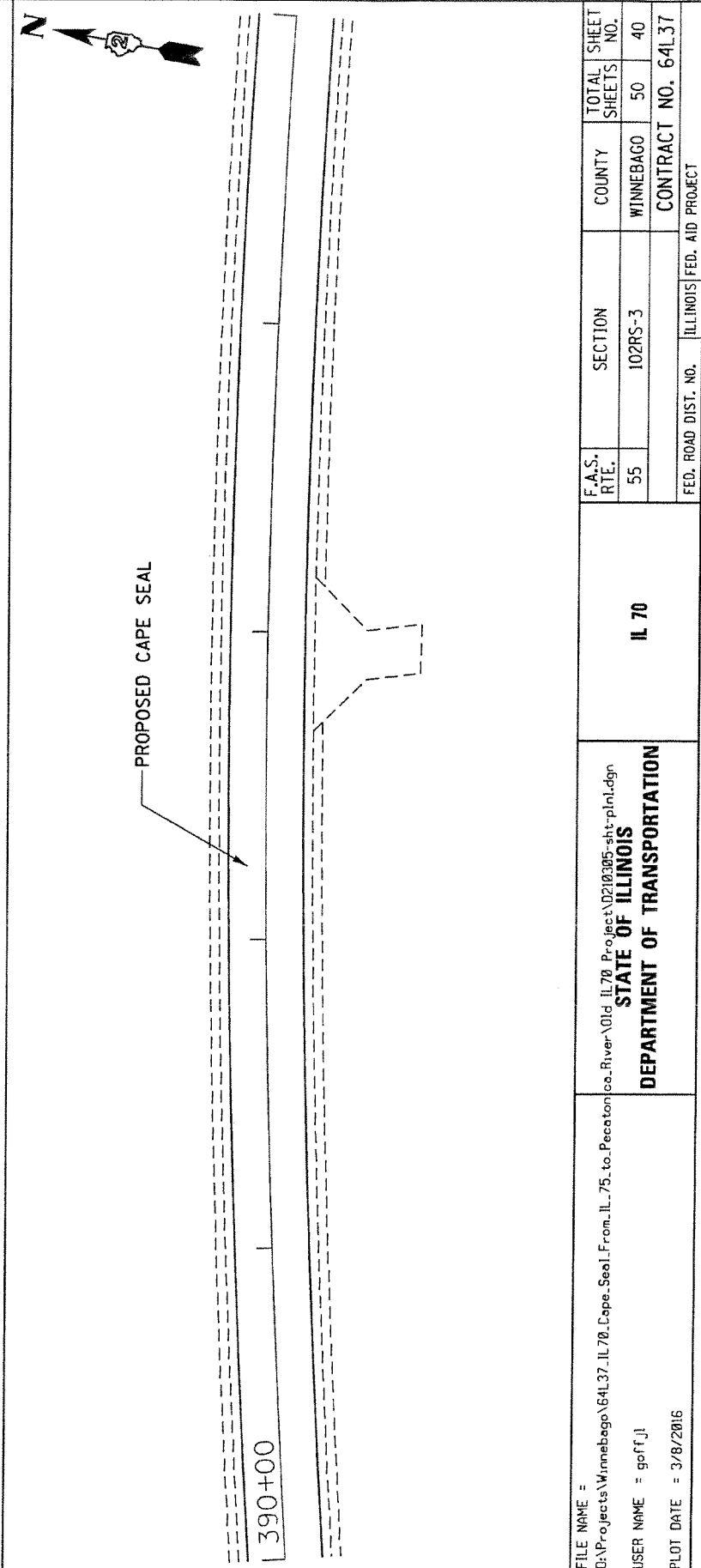
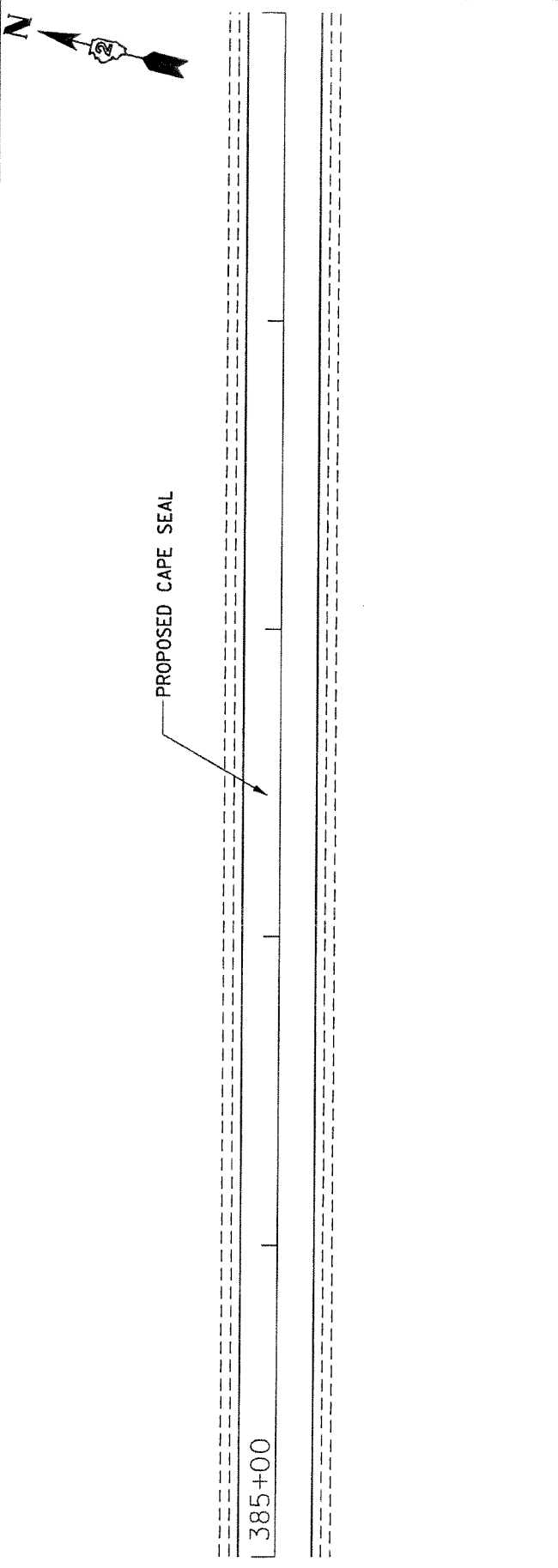

FILE NAME =		G:\Projects\Winnabago\64L37_IL70_Cape_Seal_From_IL_75_to_Pecatonica_River\01d_IL70_Project\0210305-shd-pln.dgn		TOTAL SHEETS		50	
USER NAME = goff,jl		STATE OF ILLINOIS		COUNTY		WINNEBAGO	
PLOT DATE = 3/8/2016		DEPARTMENT OF TRANSPORTATION		SECTION		102RS-3	
		IL 70		F.A.S. RTE.		55	
				FED. ROAD DIST. NO.		ILLINOIS FED. AID PROJECT	
				CONTRACT NO.		64L37	

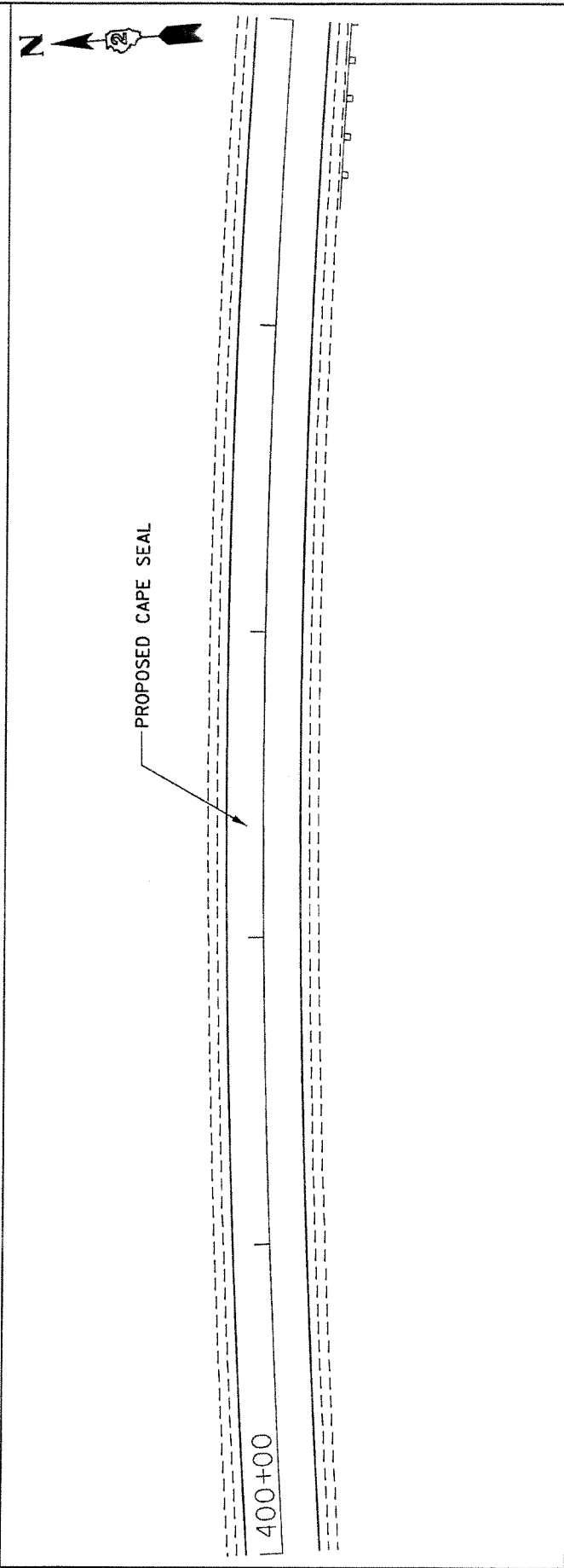
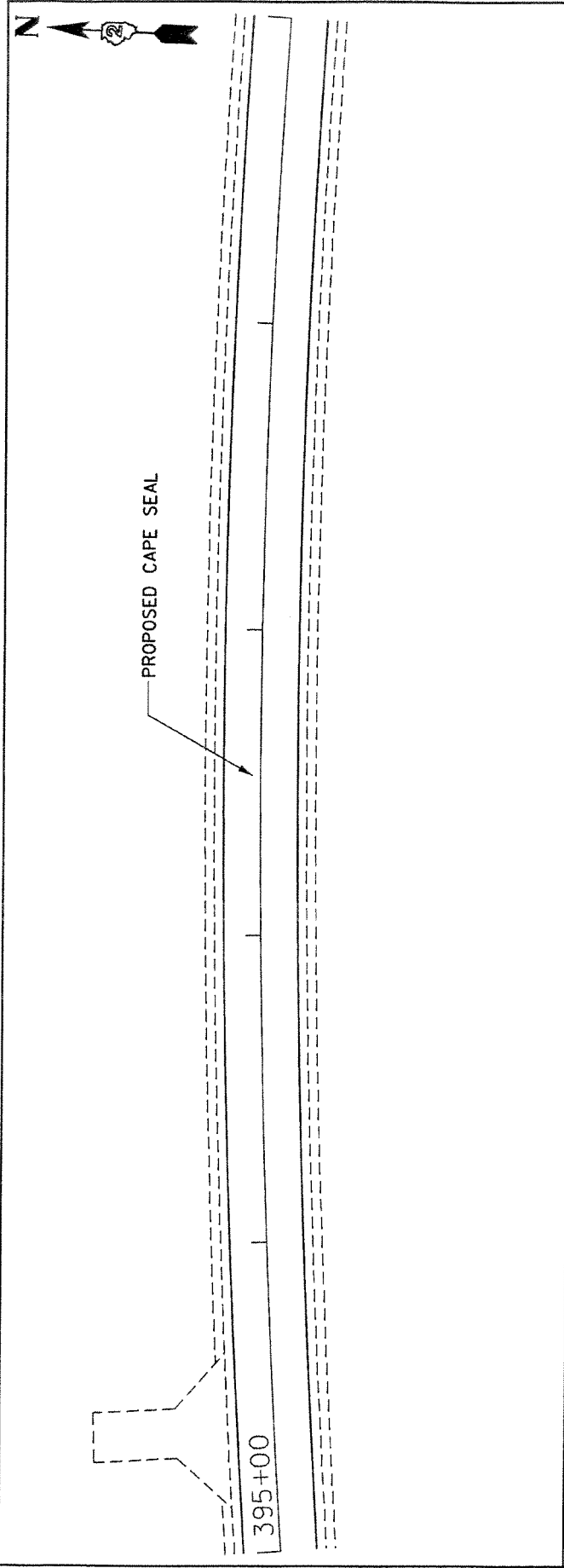

FILE NAME = D:\Projects\Winnebago\64L37_IL70_Cape_Seal_From_IL_75_to_Pecatonica_River\01d_IL70_Project\02\0305-shr-pln.dgn		IL 70		TOTAL SHEETS		SHEET NO.	
STATE OF ILLINOIS DEPARTMENT OF TRANSPORTATION		SECTION 102RS-3		COUNTY WINNEBAGO		50	
USER NAME = geffjl		F.A.S. RTE. 55		CONTRACT NO. 64L37		41	
PLOT DATE = 3/8/2016		FED. ROAD DIST. NO.		ILLINOIS FED. AID PROJECT			

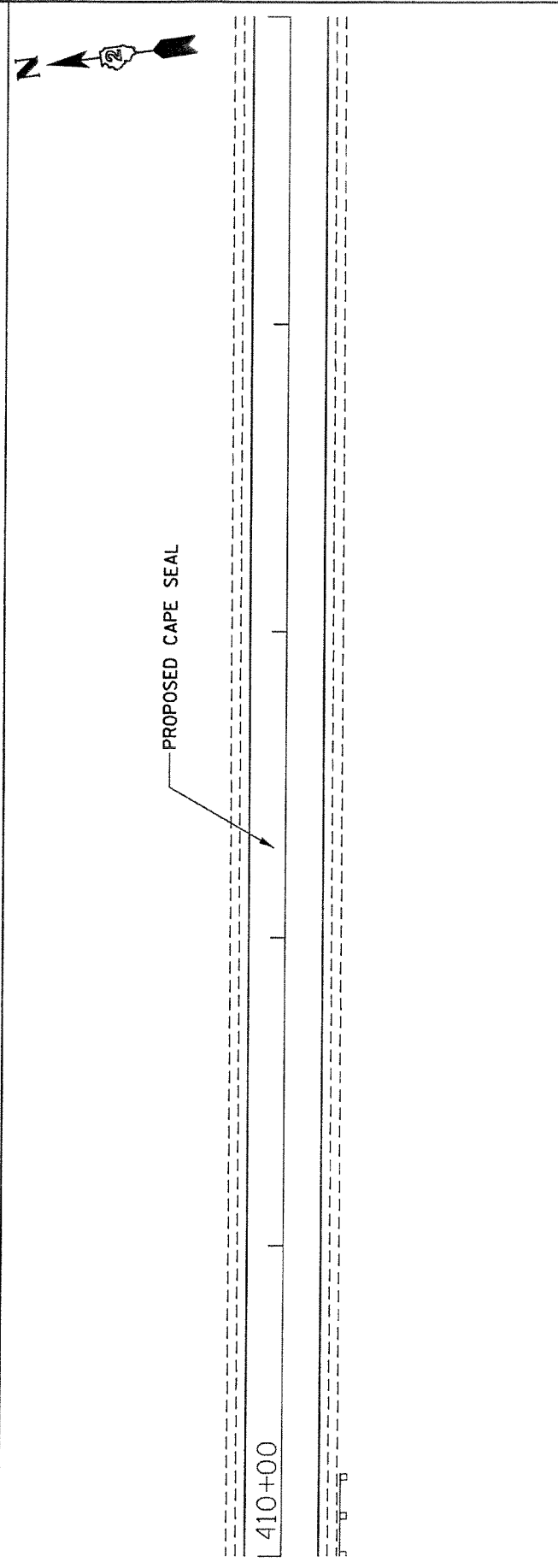
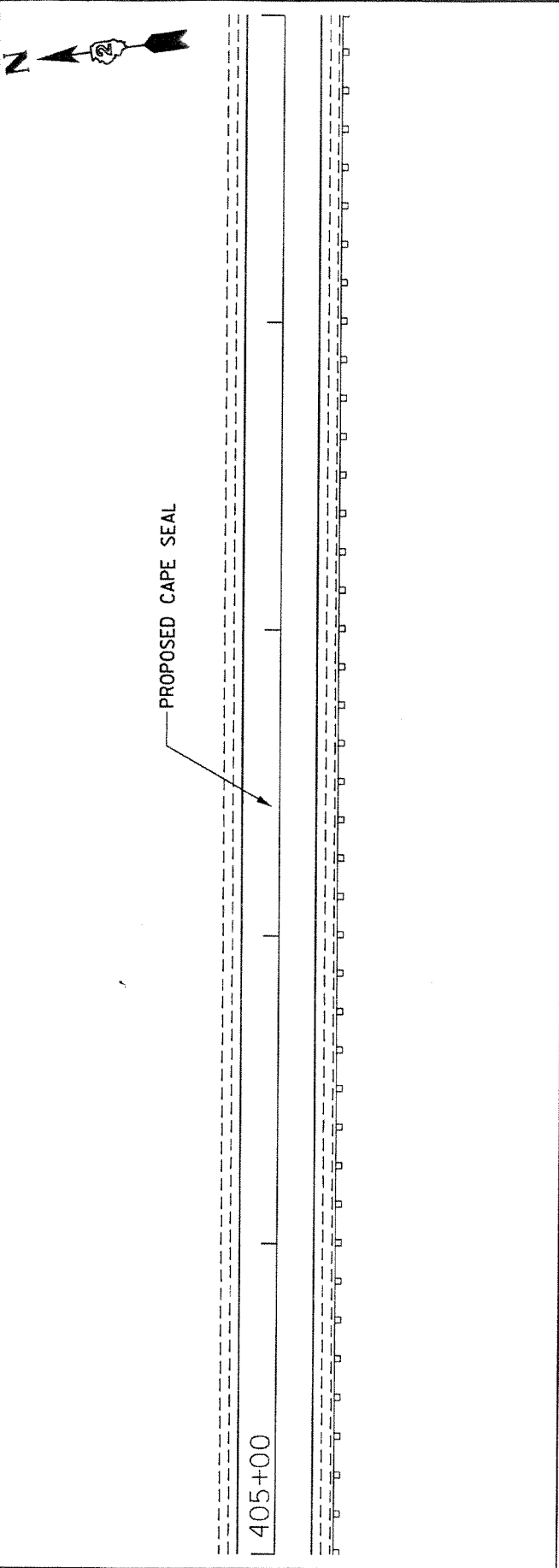

FILE NAME = D:\Projects\Winnebago\64L37_IL70.Cape_Seal_From_IL_75_to_Pecatonica_River\01d_IL70_Project\0210305-shk-pln.dgn		SECTION 102RS-3		COUNTY WINNEBAGO		TOTAL SHEETS 50		SHEET NO. 42	
STATE OF ILLINOIS DEPARTMENT OF TRANSPORTATION		IL 70		F.A.S. RTE. 55		CONTRACT NO. 64L37		FED. ROAD DIST. NO. ILLINOIS FED. AID PROJECT	
USER NAME = gff,jl		PLOT DATE = 3/8/2016							

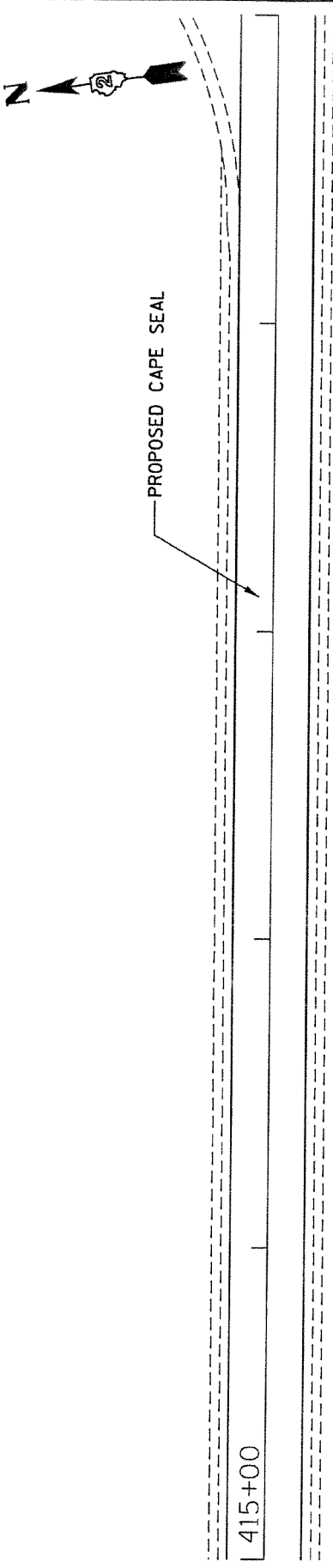

415+00

PROPOSED CAPE SEAL

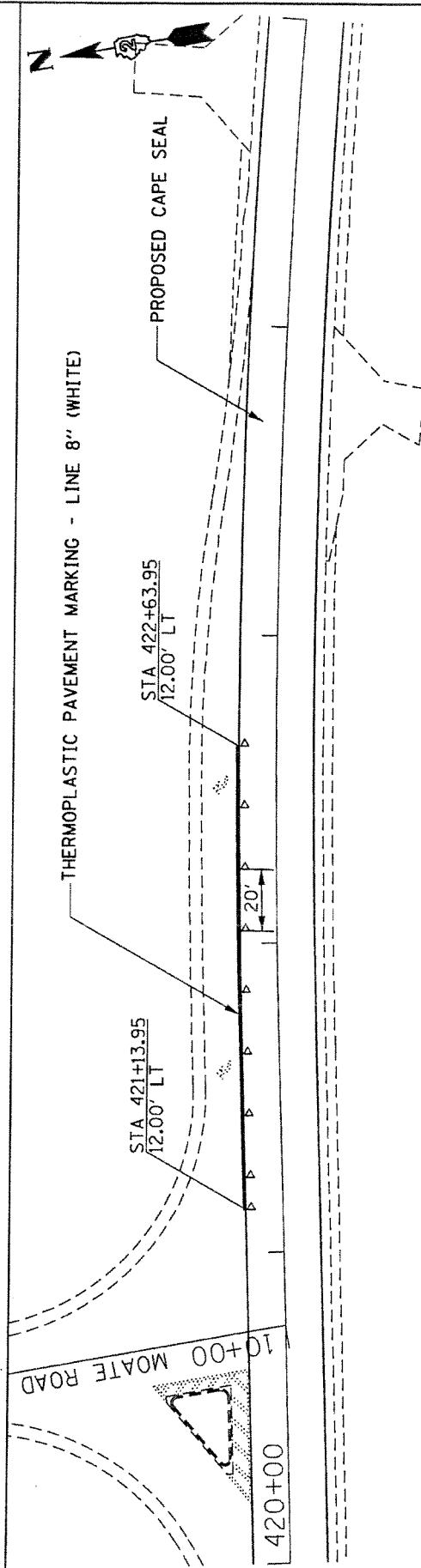

420+00

THERMOPLASTIC PAVEMENT MARKING - LINE 8" (WHITE)

STA 421+13.95  
12.00' LT

STA 422+63.95  
12.00' LT

10+00 MOATE ROAD

**LEGEND**

- ◆ = TWO-WAY AMBER MARKER
- ◁ = ONE-WAY CRYSTAL MARKER

FILE NAME =		D:\Projects\Winnebago\64L37_IL70_Cope.Seal.From_IL_75_to_Pecotom.co.River\01d_IL70_P\ject\02\0305-sht-pln.dgn		TOTAL SHEETS	
USER NAME =		geffj		NO.	
PLOT DATE =		3/8/2016		50	
F.A.S. RTE.		SECTION		COUNTY	
55		102RS-3		WINNEBAGO	
FED. ROAD DIST. NO.		ILLINOIS		FED. AID PROJECT	
IL 70		CONTRACT NO.		64L37	

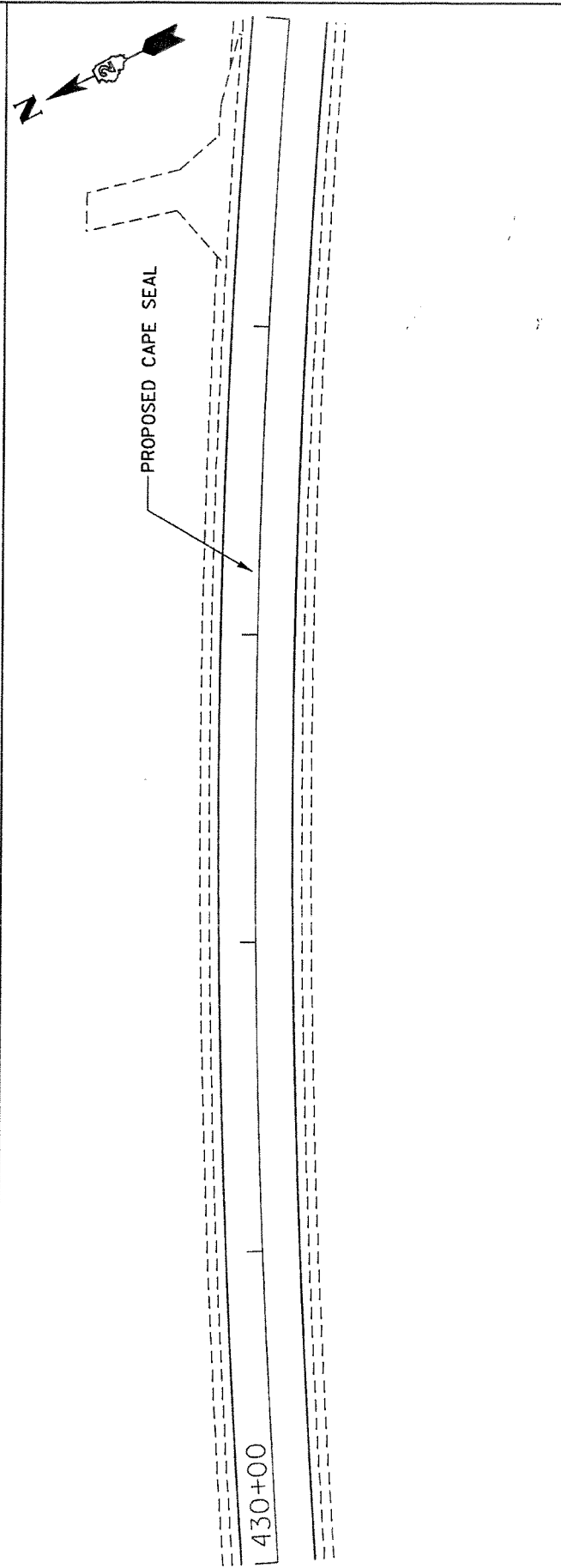
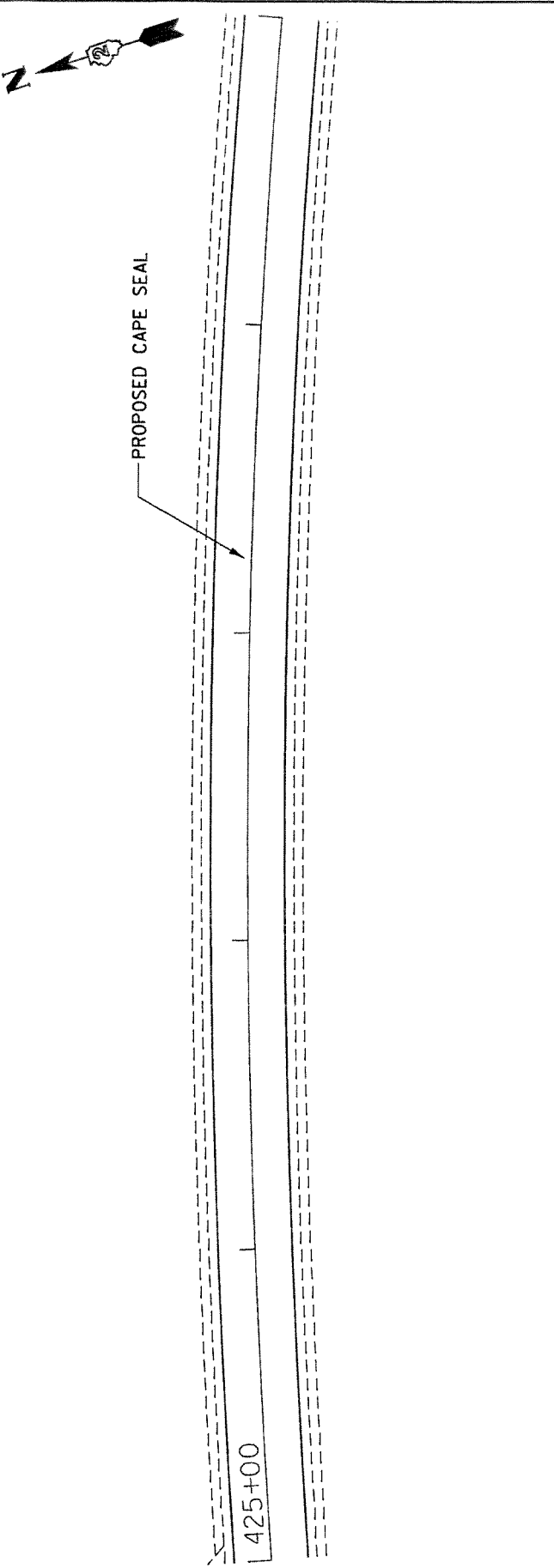

FILE NAME = C:\Projects\Winnebago\64L37_IL70_Cape_Seal_From_IL_75_to_Peaton\es.River\01d_IL70_Project\0210305-sh-t-pln.dgn		IL 70		TOTAL SHEET NO.	
STATE OF ILLINOIS		SECTION		COUNTY	
DEPARTMENT OF TRANSPORTATION		102RS-3		WINNEBAGO	
USER NAME = gsfTJ		F.A.S. RTE.		CONTRACT NO. 64L37	
PLOT DATE = 3/8/2016		55		50 44	
		FED. ROAD DIST. NO.		ILLINOIS FED. AID PROJECT	

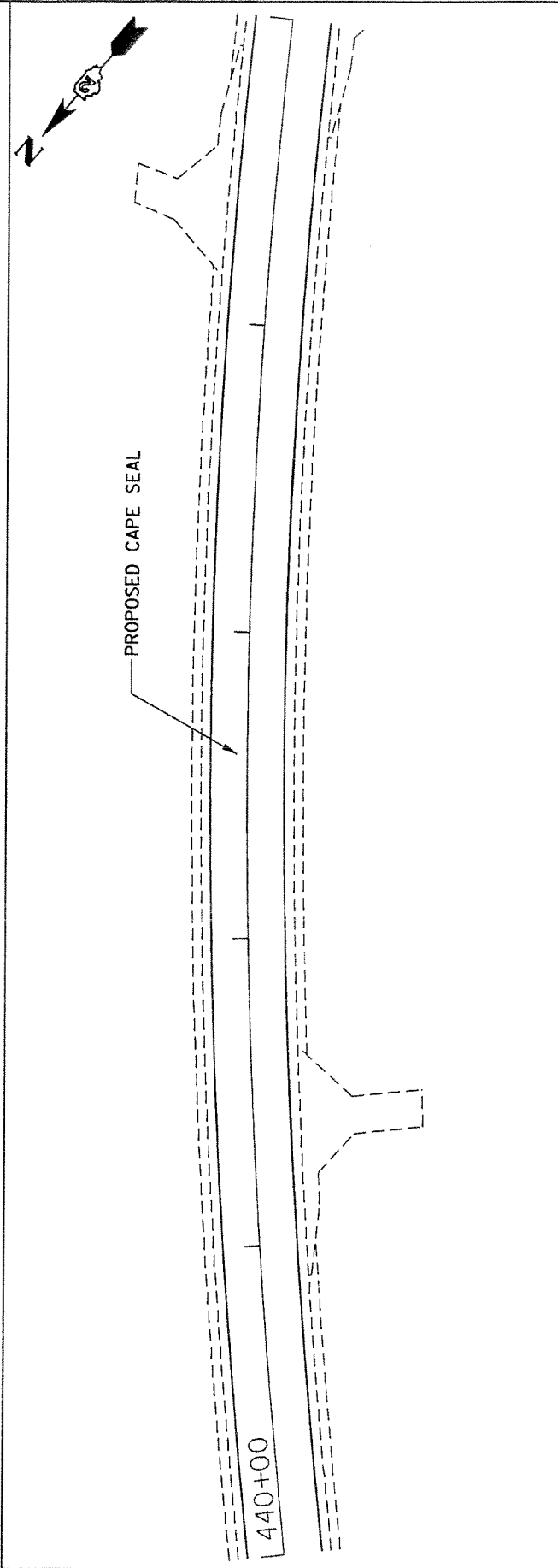
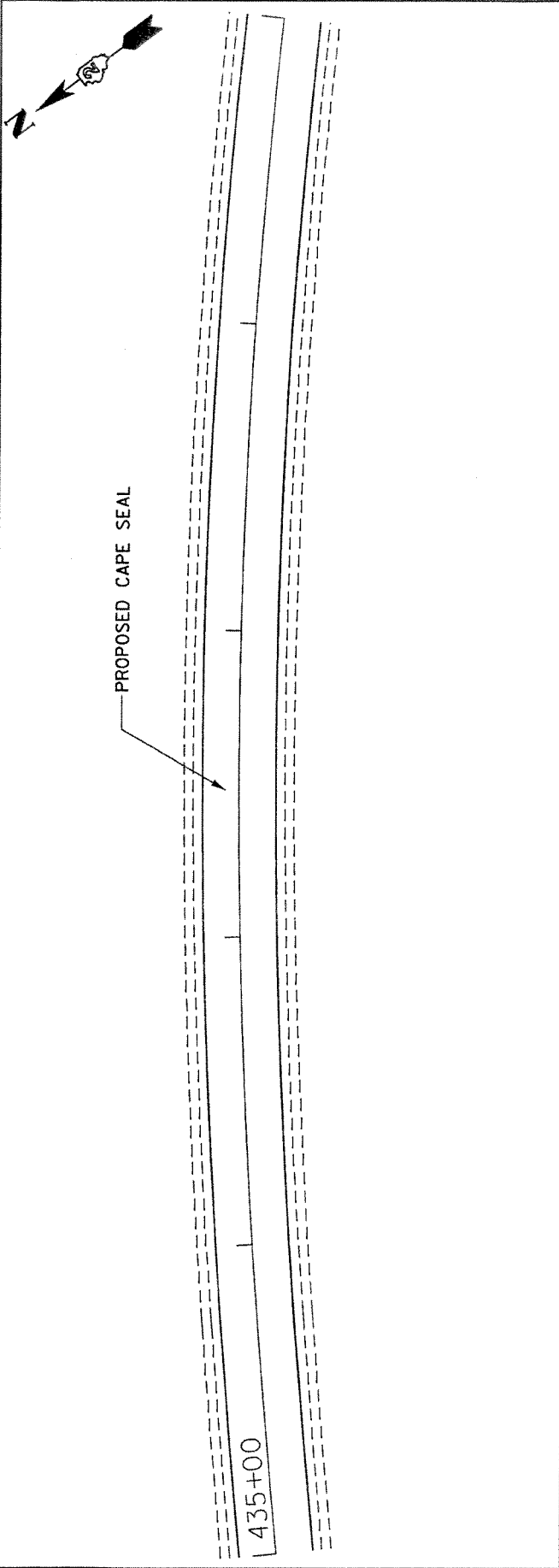

FILE NAME = 0:\Projects\Winnebago\64L37_IL70_Cape_Seal_From_IL_75_to_Pecatonica_River\01d_IL70_Project\02\0305-sht-pln.dgn		TOTAL SHEETS		TOTAL SHEETS	
STATE OF ILLINOIS		COUNTY		WINNEBAGO	
DEPARTMENT OF TRANSPORTATION		SECTION		102RS-3	
IL 70		F.A.S. RTE.		55	
		CONTRACT NO.		64L37	
USER NAME = g0fj		FED. ROAD DIST. NO.		ILLINOIS   FED. AID PROJECT	
PLOT DATE = 3/8/2016					

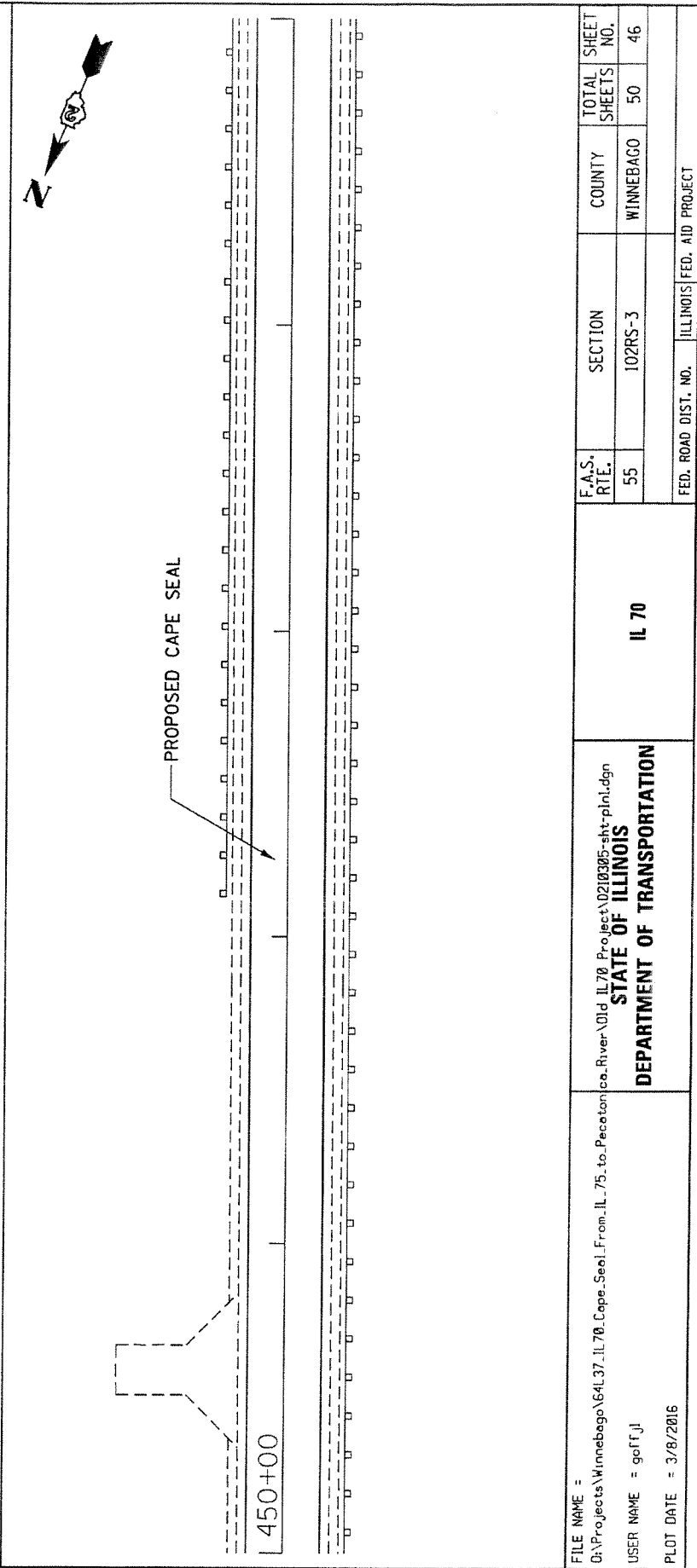
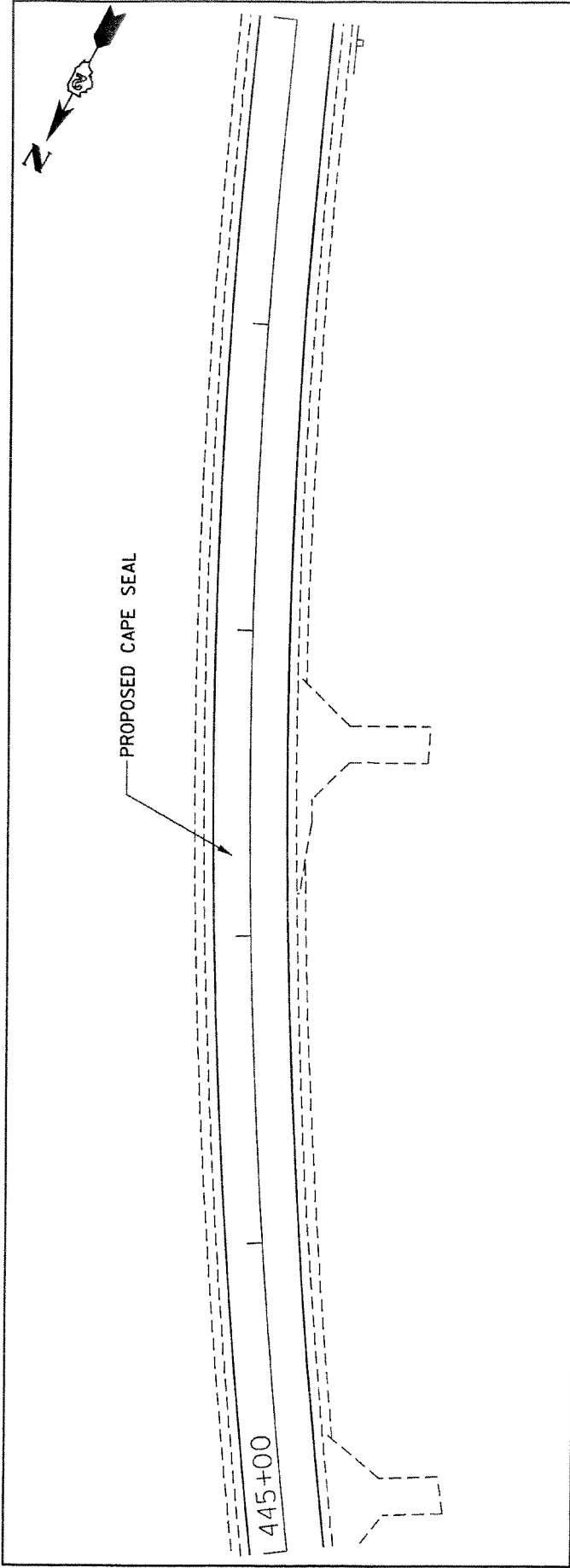

FILE NAME = D:\Projects\Winnebago\64L37_IL70_Cape_Seal_From_IL_75_to_Pecatonica_River\01\02\03\05-stt-pln.dgn		IL 70		SECTION 102RS-3		COUNTY WINNEBAGO		TOTAL SHEETS 50		SHEET NO. 46	
USER NAME = gcfTJ		STATE OF ILLINOIS DEPARTMENT OF TRANSPORTATION		E.A.S. RTE. 55		FED. ROAD DIST. NO.		ILLINOIS		FED. AID PROJECT	
PLOT DATE = 3/8/2016											



PROJECT ENDS  
STA 457+88

PROPOSED CAPE SEAL

455+00

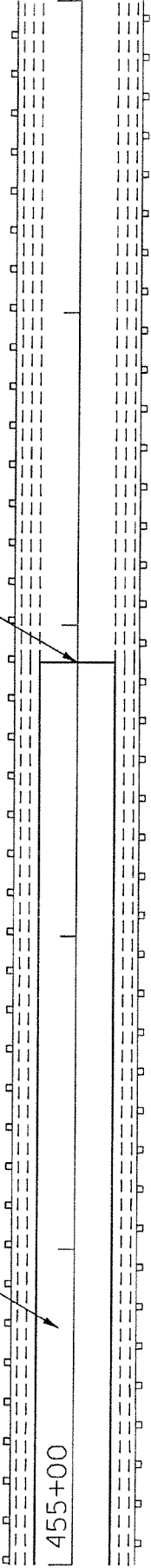

FILE NAME =

D:\Projects\Winnebago\64L37\_IL70\_Cape\_Seal\_From\_IL75\_to\_Pecatonica\_River\01d\_IL70\_Project\02\0305-sht-pln.dgn

USER NAME = goffj

PLOT DATE = 3/8/2016

E.A.S. RTE.	SECTION	COUNTY	TOTAL SHEETS	SHEET NO.
55	102RS-3	WINNEBAGO	50	47
FED. ROAD DIST. NO.		ILLINOIS FED. AID PROJECT		

IL 70

STATE OF ILLINOIS  
DEPARTMENT OF TRANSPORTATION



# TYPICAL PAVEMENT MARKINGS

## MEDIAN PAVEMENT MARKING

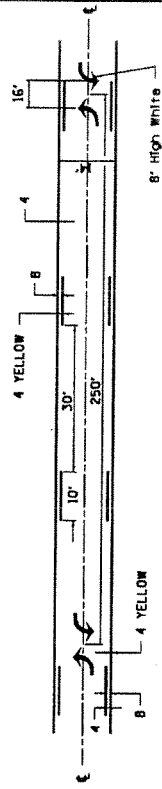

## TYPICAL PAVEMENT MARKING FOR FLUSH MEDIAN AT LEFT TURN LANE

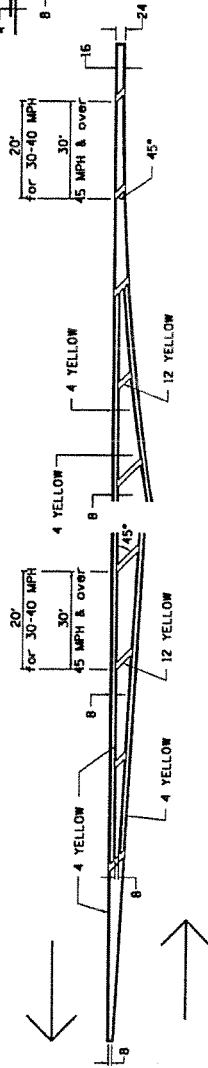

## TYPICAL ISLAND OFFSET SHOULDER WIDTH

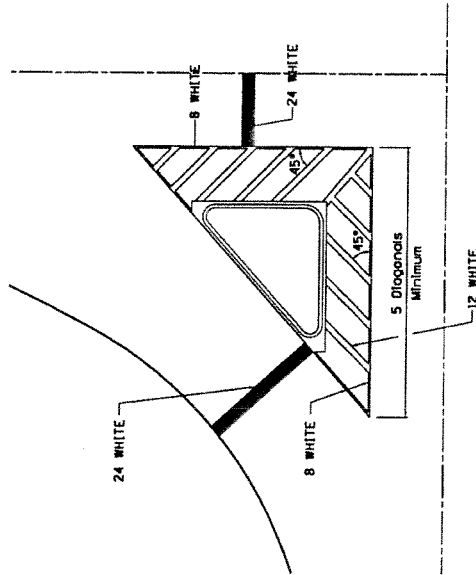

## TYPICAL MARKING FOR PAINTED ISLANDS

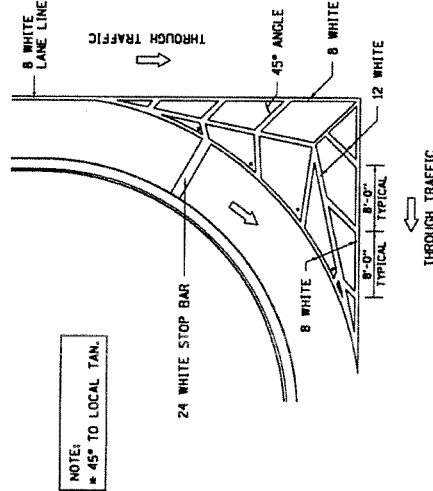

NOTE:  
= 45° TO LOCAL TAN.

\*\* ALL DIMENSIONS ARE IN INCHES UNLESS OTHERWISE NOTED.

## STANDARD CROSSWALK MARKING

See Schedules for Locations

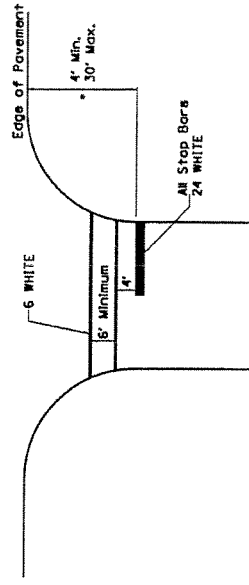

\* Distance to the nearest edge of the intersecting roadway in the absence of a marked crosswalk.

REVISED - 6-27-14  
REVISED - 3-05-12

FILE NAME =

D:\Projects\Winnebago\64L37\_IL70\_Cape\_Seal\_From\_IL\_75\_to\_Peaton

ca.River\Did IL70 Project\0218385-sht-p1n1.dgn

DISTRICT 2 STANDARD

F.A.S. COUNTY TOTAL SHEET SHEET NO.  
RTE. 55 SECTION 102RS-3 WINNEBAGO 50 48

## TYPICAL PAVEMENT MARKINGS SHEET 1 OF 3 41.1

DEPARTMENT OF TRANSPORTATION

USER NAME = gofj  
PLOT DATE = Mar-08-2016 10:54:18 AM

FED. ROAD DIST. NO. ILLINOIS FED. AID PROJECT

CONTRACT NO. 64L37



# TYPICAL PAVEMENT MARKINGS

## TYPICAL PARKING SPACING

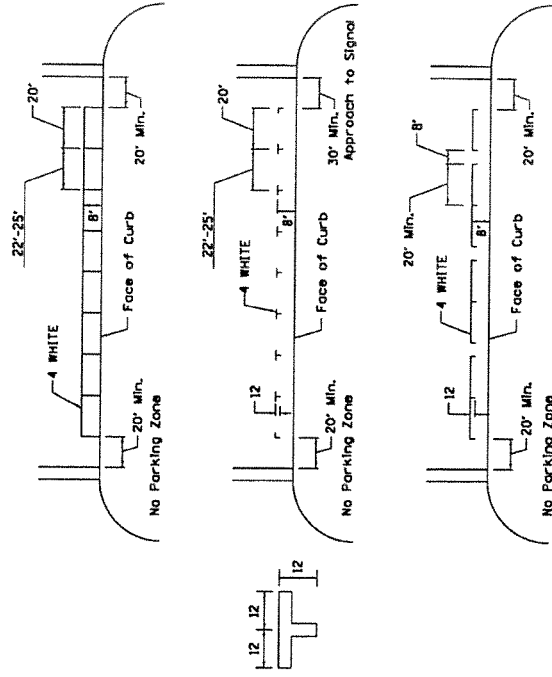

## TYPICAL PAVEMENT MARKING FOR TWO LANE SECTION - NO PASSING ZONES

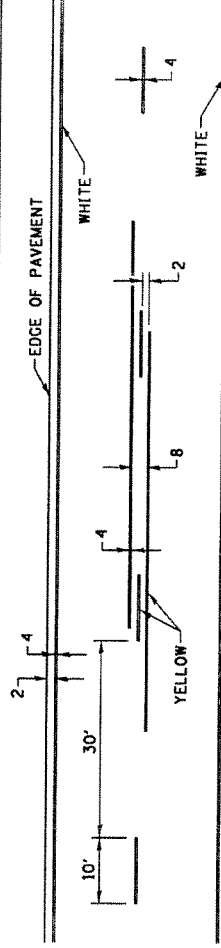

## SYMBOLS

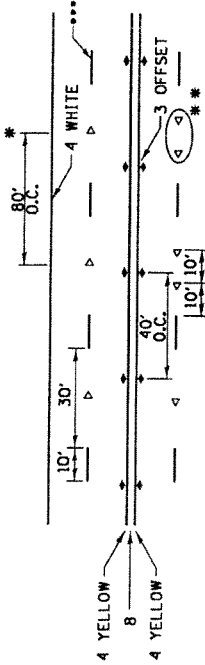

- REDUCE TO 40' O.C. ON CURVES WHERE ADVISORY SPEEDS ARE 10 MPH LOWER THAN POSTED SPEEDS.
- USE DOUBLE MARKERS WHEN ADT  $\geq$  20,000
- CENTERLINE SKIP DASH PAVEMENT MARKING SPEED LIMIT LESS THAN 40 MPH USE 4" LINE. SPEED LIMIT 40 MPH AND OVER USE 6" LINE.

## MULTI-LANE / UNDIVIDED & ONE WAY

(FOR MULTI-LANE UNDIVIDED HIGHWAYS, USE THIS DETAIL NOT HIGHWAY STANDARD 781001)

REVISED - 6-27-14  
 REVISED - 8-27-13  
 REVISED - 11-28-12

FILE NAME =

D:\Projects\Winnebago\64L37\_IL78\_Cape\_Sea\_L\_From\_IL\_75\_to\_Peaton\Co-River\01d\_IL78\_Project\0210385-sht-pln.dgn

STATE OF ILLINOIS  
 DEPARTMENT OF TRANSPORTATION

DISTRICT 2 STANDARD

F.A.S. R.T.E.	SECTION	COUNTY	TOTAL SHEETS	SHEET NO.
55	102BS-3	WINNEBAGO	50	50
FED. ROAD DIST. NO. - ILLINOIS FED. AID PROJECT			CONTRACT NO. 64L37	

## TYPICAL PAVEMENT MARKINGS SHEET 3 OF 3 41.1

PLOT DATE = Mar-08-2016 10:54:37 AM

USER NAME = goffj

## **REVISIONS TO THE ILLINOIS PREVAILING WAGE RATES**

The Prevailing rates of wages are included in the Contract proposals which are subject to Check Sheet #5 of the Supplemental Specifications and Recurring Special Provisions. The rates have been ascertained and certified by the Illinois Department of Labor for the locality in which the work is to be performed and for each craft or type of work or mechanic needed to execute the work of the Contract. As required by Prevailing Wage Act (820 ILCS 130/0.01, et seq.) and Check Sheet #5 of the Contract, not less than the rates of wages ascertained by the Illinois Department of Labor and as revised during the performance of a Contract shall be paid to all laborers, workers and mechanics performing work under the Contract. Post the scale of wages in a prominent and easily accessible place at the site of work.

If the Illinois Department of Labor revises the prevailing rates of wages to be paid as listed in the specification of rates, the contractor shall post the revised rates of wages and shall pay not less than the revised rates of wages. Current wage rate information shall be obtained by visiting the Illinois Department of Labor web site at <http://www.state.il.us/agency/idol/> or by calling 312-793-2814. It is the responsibility of the contractor to review the rates applicable to the work of the contract at regular intervals in order to insure the timely payment of current rates. Provision of this information to the contractor by means of the Illinois Department of Labor web site satisfies the notification of revisions by the Department to the contractor pursuant to the Act, and the contractor agrees that no additional notice is required. The contractor shall notify each of its subcontractors of the revised rates of wages.