

F.A.P. RTE.	SECTION	COUNTY	TOTAL SHEETS	SHEET NO.
326	105 RS-9	MCHENRY	37	1
FED. ROAD DIST. NO.	ILLINOIS	CONTRACT NO. 60H33		

D-91-603-09



STATE OF ILLINOIS  
DEPARTMENT OF TRANSPORTATION  
DIVISION OF HIGHWAYS

**PROPOSED  
HIGHWAY PLANS**

FAP ROUTE 326 (ILL ROUTE 47)  
ILL ROUTE 120 (MCHENRY AVENUE) TO ILL ROUTE 176

SECTION: 105 RS-9  
RESURFACING (3P)  
MCHENRY COUNTY  
C-91-603-09

PROJECT LOCATED IN AND ADJACENT  
TO THE VILLAGE OF WOODSTOCK

FOR INDEX OF SHEETS, SEE SHEET NO. 2

ADT 16,300 (2007)  
SPEED LIMIT 55 MPH

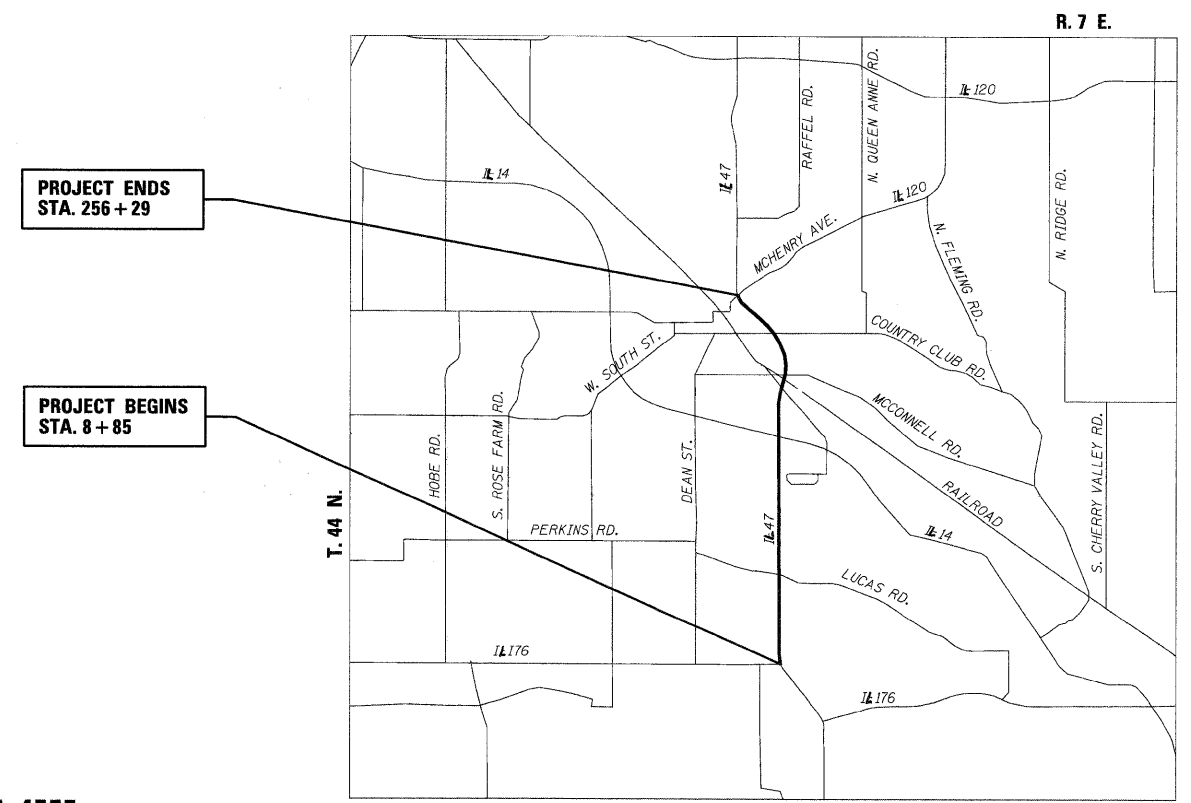

PROJECT ENDS  
STA. 256 + 29

PROJECT BEGINS  
STA. 8 + 85

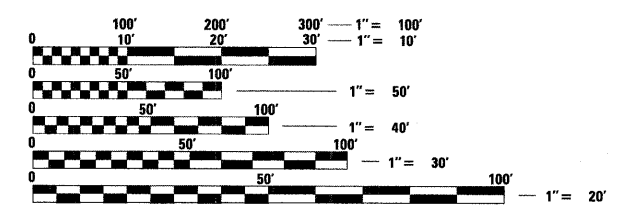

FULL SIZE PLANS HAVE BEEN PREPARED USING STANDARD  
ENGINEERING SCALES. REDUCED SIZED PLANS WILL NOT  
CONFORM TO STANDARD SCALES. IN MAKING MEASUREMENTS  
ON REDUCED PLANS, THE ABOVE SCALES MAY BE USED.

J.U.L.I.E.  
JOINT UTILITY LOCATION INFORMATION FOR EXCAVATION  
1-800-892-0123  
OR 811

PROJECT MANAGER: RAJENDRA C. SHAH (847) 705-4555  
PROJECT ENGINEER: ERSKINE W. KLYCE (847) 705-4594

CONTRACT NO. 60H33

LOCATION SKETCH

NET AND GROSS LENGTH OF PROJECT = 24,744' = 4.686 MI

STATE OF ILLINOIS  
DEPARTMENT OF TRANSPORTATION  
DIVISION OF HIGHWAYS

SUBMITTED APRIL 21, 20 09  
Diana M. O'Keefe DEPUTY DIRECTOR OF HIGHWAYS, REGION ENGINEER  
May 1, 20 09  
Charles J. Ingersoll ENGINEER OF DESIGN AND ENVIRONMENT  
May 1, 20 09  
Christine M. Reed DIRECTOR OF HIGHWAYS, CHIEF ENGINEER

PRINTED BY THE AUTHORITY  
OF THE STATE OF ILLINOIS

LOKO, INC.  
CONSULTING ENGINEERS  
1560 WALL ST., SUITE 222  
NAPERVILLE, ILLINOIS 60563 PH: (630) 577-9100

WILLIAM H. EBER  
092-047827  
REGISTERED  
PROFESSIONAL  
ENGINEER  
*William H. Eber*  
Expires 11/30/09

INDEX OF SHEETS

STATE STANDARDS

PLAN NOTES

<u>SHEET NO.</u>	<u>DESCRIPTION</u>
1	TITLE SHEET
2	INDEX OF SHEETS, STATE STANDARDS, GENERAL NOTES AND MIX SCHEDULE
3-4	SUMMARY OF QUANTITIES
5	EXISTING AND PROPOSED TYPICAL SECTIONS
6-14	ROADWAY AND PAVEMENT MARKING PLANS
15-21	DETECTOR LOOP PLANS
22	DRIVEWAY DETAILS - DISTANCE BETWEEN R.O.W. AND CURB OR EDGE GREATER THAN OR EQUAL TO 15' (4.5m)
23	DRIVEWAY DETAILS - DISTANCE BETWEEN R.O.W. AND FACE OF CURB IS LESS THAN 15' (4.5m)
24	DETAILS FOR FRAMES AND LIDS ADJUSTMENT WITH MILLING
25	PAVEMENT PATCHING FOR HMA SURFACED PAVEMENT
26	CURB OR CURB AND GUTTER REMOVAL AND REPLACEMENT
27	BUTT JOINT AND HMA TAPER DETAILS
28	TRAFFIC CONTROL AND PROTECTION FOR SIDE ROADS, INTERSECTIONS, AND DRIVEWAYS
29	TYPICAL APPLICATIONS RAISED REFLECTIVE PAVEMENT MARKERS (SNOW-PLOW RESISTANT)
30	DISTRICT ONE TYPICAL PAVEMENT MARKINGS
31	TRAFFIC CONTROL AND PROTECTION AT TURN BAYS (TO REMAIN OPEN TO TRAFFIC)
32	PAVEMENT MARKING LETTERS AND SYMBOLS FOR TRAFFIC STAGING
33	TRAFFIC CONTROL FOR SHOULDER CLOSURES AND PARTIAL RAMP CLOSURES
34	SIGNING FOR FLAGGING OPERATIONS AT WORK ZONE OPENINGS
35	ARTERIAL ROAD INFORMATION SIGN
36	DRIVEWAY ENTRANCE SIGNING
37	DISTRICT ONE DETECTOR LOOP INSTALLATION DETAILS FOR ROADWAY RESURFACING
	STATE STANDARDS

<u>STANDARD NO.</u>	<u>DESCRIPTION</u>
000001-05	STANDARD SYMBOLS, ABBREVIATIONS AND PATTERNS
442201-03	CLASS C AND D PATCHES
482011-03	HMA SHLD. STRIPS/SHLDS. WITH RESURFACING OR WIDENING AND RESURFACING PROJECTS
606001-04	CONCRETE CURB TYPE B AND COMBINATION CONCRETE CURB AND GUTTER
606301-04	PC CONCRETE ISLANDS AND MEDIANS
606306-03	CORRUGATED PC CONCRETE MEDIANS
642001-01	SHOULDER RUMBLE STRIPS
701006-03	OFF-RD OPERATIONS, 2L, 2W, MORE THAN 15' (4.5 M) TO 24" (600MM) FROM PAVEMENT EDGE
701011-02	OFF-RD MOVING OPERATIONS, 2L, 2W, DAY ONLY
701101-02	OFF-RD OPERATIONS, MULTILANE, 15' (4.5 M) TO 24" (600MM) FROM PAVEMENT EDGE
701201-03	LANE CLOSURE, 2L, 2W, DAY ONLY, FOR SPEEDS LESS THAN 45 MPH
701206-02	LANE CLOSURE, 2L, 2W, NIGHT ONLY, FOR SPEEDS LESS THAN 45 MPH
701301-03	LANE CLOSURE, 2L, 2W, SHORT TIME OPERATIONS
701306-02	LANE CLOSURE, 2L, 2W, SLOW MOVING OPERATIONS DAY ONLY, FOR SPEEDS LESS THAN 45 MPH
701311-03	LANE CLOSURE, 2L, 2W, MOVING OPERATIONS-DAY ONLY
701336-05	LANE CLOSURE, 2L, 2W, WORK AREAS IN SERIES, FOR SPEEDS LESS THAN 45 MPH
701426-03	LANE CLOSURE, MULTILANE, INTERMITTENT OR MOVING OPERATIONS FOR SPEEDS LESS THAN 45 MPH
701501-05	URBAN LANE CLOSURE, 2L, 2W, UNDIVIDED
701606-06	URBAN LANE CLOSURE, MULTILANE, 2W WITH MOUNTABLE MEDIAN
701701-06	URBAN LANE CLOSURE, MULTILANE INTERSECTION
701801-04	LANE CLOSURE MULTILANE 1W OR 2W CROSSWALK OR SIDEWALK CLOSURE
701901-01	TRAFFIC CONTROL DEVICES
814001-02	HANDHOLES
886001-01	DETECTOR LOOP INSTALLATIONS
886006-01	TYPICAL LAYOUTS FOR DETECTION LOOPS

BEFORE STARTING ANY EXCAVATION, THE CONTRACTOR SHALL CALL "JULIE" AT 800-892-0123 FOR FIELD LOCATIONS OF BURIED ELECTRIC, TELEPHONE AND GAS FACILITIES. (48 HOUR NOTIFICATION IS REQUIRED)

THE CONTRACTOR SHALL COORDINATE CONSTRUCTION ACTIVITIES WITH UTILITY COMPANIES WITHIN THE VILLAGE OF WOODSTOCK.

THE CONTRACTOR WILL NOT BE ALLOWED TO SET UP A YARD OF FIELD OFFICE ON STATE PROPERTY WITHOUT WRITTEN PERMISSION FROM THE DEPARTMENT.

BUTT JOINTS WILL BE INSTALLED AT THE ENDS OF ALL RESURFACING (WHERE RESURFACING MEETS EXISTING PAVEMENT). IN ACCORDANCE WITH THE "BUTT JOINT AND HOT-MIX ASPHALT TAPER DETAILS" SHEETS INCLUDED ON THE PLANS. UNLESS OTHERWISE SPECIFIED.

THE RESIDENT ENGINEER SHALL CONTACT MR. DON CHIARUGI AREA TRAFFIC FIELD ENGINEER AT (847) 741-9857 A MINIMUM OF 2 WEEKS PRIOR TO PLACEMENT OF PERMANENT PAVEMENT MARKING.

10 FEET (3 METERS) TRANSITION SHALL BE USED TO MATCH PROPOSED CURB AND GUTTER TO EXISTING CURB AND GUTTERS IN THE FIELD, UNLESS OTHERWISE SHOWN. THE TRANSITION SHALL BE PAID FOR AT THE CONTRACT UNIT PRICE FOR THE PROPOSED ITEMS OR WORK SPECIFIED.

WHEN MILLED PAVEMENT IS OPEN TO TRAFFIC THE MAXIMUM GRADE DIFFERENTIAL BETWEEN PASSES OF THE MILLING MACHINE SHALL NOT EXCEED 1/2 INCHES (40MM) WHERE THE SPEED LIMIT IS 45 MPH (80 KM/H) OR LESS AND 1 INCH (25MM) WHERE THE SPEED LIMIT IS GREATER THAN 45 MPH (80 KM/H). WITH WRITTEN APPROVAL FROM THE ENGINEER, A MAXIMUM GRADE DIFFERENTIAL OF 3 INCHES (75MM) MAY BE ALLOWED IF THE EDGE OF THE MILLING IS SLOPED A MINIMUM 1:3 (V:H).

SUMMARY OF QUANTITIES			URBAN	CONSTRUCTION TYPE CODE		SUMMARY OF QUANTITIES			URBAN	CONSTRUCTION TYPE CODE	
CODE NO.	ITEM	UNIT	TOTAL QUANTITIES	1000 100% STATE		CODE NO.	ITEM	UNIT	TOTAL QUANTITIES	1000 100% STATE	
20201006	GRADING AND SHAPING SHOULDERS	UNIT	212	212		70100450	TRAFFIC CONTROL AND PROTECTION, STANDARD 701201	L SUM	1	1	
40600200	BITUMINOUS MATERIALS (PRIME COAT)	TON	111	111		70100460	TRAFFIC CONTROL AND PROTECTION, STANDARD 701306	L SUM	1	1	
40600300	AGGREGATE (PRIME COAT)	TON	30	30		70100600	TRAFFIC CONTROL AND PROTECTION, STANDARD 701336	L SUM	1	1	
40600400	MIXTURE FOR CRACKS, JOINTS, AND FLANGEWAYS	TON	61	61		70102620	TRAFFIC CONTROL AND PROTECTION, STANDARD 701501	L SUM	1	1	
40600895	CONSTRUCTING TEST STRIP	EACH	1	1		70102625	TRAFFIC CONTROL AND PROTECTION, STANDARD 701606	L SUM	1	1	
40600982	HOT-MIX ASPHALT SURFACE REMOVAL - BUTT JOINT	SQ YD	5284	5284		70102630	TRAFFIC CONTROL AND PROTECTION, STANDARD 701601	L SUM	1	1	
40601005	HOT-MIX ASPHALT REPLACEMENT OVER PATCHES	TON	1685	1685		70102635	TRAFFIC CONTROL AND PROTECTION, STANDARD 701701	L SUM	1	1	
40603340	HOT-MIX ASPHALT SURFACE COURSE, MIX "D", N70	TON	14033	14033		70102640	TRAFFIC CONTROL AND PROTECTION, STANDARD 701801	L SUM	1	1	
42001300	PROTECTIVE COAT	SQ YD	1381	1381		<del>70106800</del>	<del>CHANGEABLE MESSAGE SIGN</del>	<del>CAL MO</del>	<del>1</del>	<del>1</del>	
44000155	HOT-MIX ASPHALT SURFACE REMOVAL, 1 1/2"	SQ YD	8675	8675		70300100	SHORT-TERM PAVEMENT MARKING	FOOT	5900	5900	
44000158	HOT-MIX ASPHALT SURFACE REMOVAL, 2 1/4"	SQ YD	145261	145261		70300210	TEMPORARY PAVEMENT MARKING - LETTERS AND SYMBOLS	SQ FT	1642	1642	
44001700	COMBINATION CONCRETE CURB AND GUTTER REMOVAL AND REPLACEMENT	FOOT	500	500		70300220	TEMPORARY PAVEMENT MARKING - LINE 4"	FOOT	82341	82341	
44002216	HOT-MIX ASPHALT REMOVAL OVER PATCHES, 4"	SQ YD	7520	7520		70300240	TEMPORARY PAVEMENT MARKING - LINE 6"	FOOT	3267	3267	
44201765	CLASS D PATCHES, TYPE II, 10 INCH	SQ YD	3327	3327		70300250	TEMPORARY PAVEMENT MARKING - LINE 8"	FOOT	452	452	
44201769	CLASS D PATCHES, TYPE III, 10 INCH	SQ YD	3361	3361		70300260	TEMPORARY PAVEMENT MARKING - LINE 12"	FOOT	4320	4320	
44201771	CLASS D PATCHES, TYPE IV, 10 INCH	SQ YD	832	832		70300280	TEMPORARY PAVEMENT MARKING - LINE 24"	FOOT	1683	1683	
48102100	AGGREGATE WEDGE SHOULDER, TYPE B	TON	692	692		70301000	WORK ZONE PAVEMENT MARKING REMOVAL	SQ FT	38709	38709	
55039700	STORM SEWERS TO BE CLEANED	FOOT	1240	1240		* 78000100	THERMOPLASTIC PAVEMENT MARKING - LETTERS AND SYMBOLS	SQ FT	1642	1642	
60250200	CATCH BASINS TO BE ADJUSTED	EACH	8	8		* 78000200	THERMOPLASTIC PAVEMENT MARKING - LINE 4"	FOOT	82341	82341	
60255500	MANHOLES TO BE ADJUSTED	EACH	12	12		* 78000400	THERMOPLASTIC PAVEMENT MARKING - LINE 6"	FOOT	3267	3267	
60260100	INLETS TO BE ADJUSTED	EACH	14	14		* 78000500	THERMOPLASTIC PAVEMENT MARKING - LINE 8"	FOOT	452	452	
60300105	FRAMES AND GRATES TO BE ADJUSTED	EACH	18	18		* 78000600	THERMOPLASTIC PAVEMENT MARKING - LINE 12"	FOOT	4320	4320	
60300310	FRAMES AND LIDS TO BE ADJUSTED (SPECIAL)	EACH	71	71		* 78000650	THERMOPLASTIC PAVEMENT MARKING - LINE 24"	FOOT	1683	1683	
67000400	ENGINEER'S FIELD OFFICE, TYPE A	CAL MO	6	6		* 78100100	RAISED REFLECTIVE PAVEMENT MARKER	EACH	1581	1581	
67100100	MOBILIZATION	L SUM	1	1		78300200	RAISED REFLECTIVE PAVEMENT MARKER REMOVAL	EACH	1581	1581	

\* Specialty Items

Rev.

 CONSULTING ENGINEERS 1979 N. MILL ST., SUITE 210 NAPERVILLE, ILLINOIS 60563 PH: (630) 577-9100	USER NAME = #USER#	DESIGNED - MJY	REVISED -	<b>STATE OF ILLINOIS</b> <b>DEPARTMENT OF TRANSPORTATION</b>	<b>SUMMARY OF QUANTITIES</b> <b>IL ROUTE 47 FROM IL ROUTE 176 TO IL ROUTE 120</b>	F.A.P. RTE.	SECTION	COUNTY	TOTAL SHEETS	SHEET NO.	
	PLOT SCALE = #SCALE#	CHECKED - MJY	REVISED -			326	105 RS-9	MCHENRY	37	3	
	PLOT DATE = #DATE#	DATE - 04/22/2009	REVISED -			C-91-603-09		CONTRACT NO. 60H33			
					SCALE: NONE	SHEET NO. 3 OF 37 SHEETS	STA. 8+85 TO STA. 256+29	FED. ROAD DIST. NO. ILLINOIS FED. AID PROJECT			

SUMMARY OF QUANTITIES			URBAN CONSTRUCTION TYPE CODE			SUMMARY OF QUANTITIES			CONSTRUCTION TYPE CODE		
CODE NO.	ITEM	UNIT	TOTAL QUANTITIES	1000 100% STATE	TOTAL COST	CODE NO.	ITEM	UNIT	TOTAL QUANTITIES	1000 100% STATE	TOTAL COST
* 87301305	ELECTRIC CABLE IN CONDUIT, LEAD-IN, NO. 14 1 PAIR	FOOT	1572	1572							
* 88500100	INDUCTIVE LOOP DETECTOR	EACH	10	10							
* 88600100	DETECTOR LOOP, TYPE I	FOOT	1148	1148							
* 88600600	DETECTOR LOOP REPLACEMENT	FOOT	4941	4941							
X0322256	TEMPORARY INFORMATION SIGNING	SQ FT	160	160							
X4067107	POLYMERIZED LEVELING BINDER (MACHINE METHOD), IL-4.75, N50	TON	6101	6101							
<del>44004600</del>	SIDEWALK REMOVAL AND REPLACEMENT	SQ FT	350	350							
Z0018500	DRAINAGE STRUCTURES TO BE CLEANED	EACH	5	5							
Z0048665	RAILROAD PROTECTIVE LIABILITY INSURANCE	L SUM	1	1							
	* Specialty Items										

**LOVCO, INC.**  
CONSULTING ENGINEERS  
1979 N. MILL ST., SUITE 210  
NAPERVILLE, ILLINOIS 60563 PH: (630) 577-9100

USER NAME = *USER*	DESIGNED - MJY	REVISED -
	DRAWN - RJG	REVISED -
PLOT SCALE = *SCALE*	CHECKED - MJY	REVISED -
PLOT DATE = *DATE*	DATE - 04/22/2009	REVISED -

**STATE OF ILLINOIS  
DEPARTMENT OF TRANSPORTATION**

**SUMMARY OF QUANTITIES**  
IL ROUTE 47 FROM IL ROUTE 176 TO IL ROUTE 120  
SCALE: NONE SHEET NO. 4 OF 37 SHEETS STA. 8+85 TO STA. 256+29

F.A.P. RTE.	SECTION	COUNTY	TOTAL SHEETS	SHEET NO.
326	105 RS-9	MCHENRY	37	4
C-91-603-09			CONTRACT NO. 60H33	
FED. ROAD DIST. NO.		ILLINOIS FED. AID PROJECT		

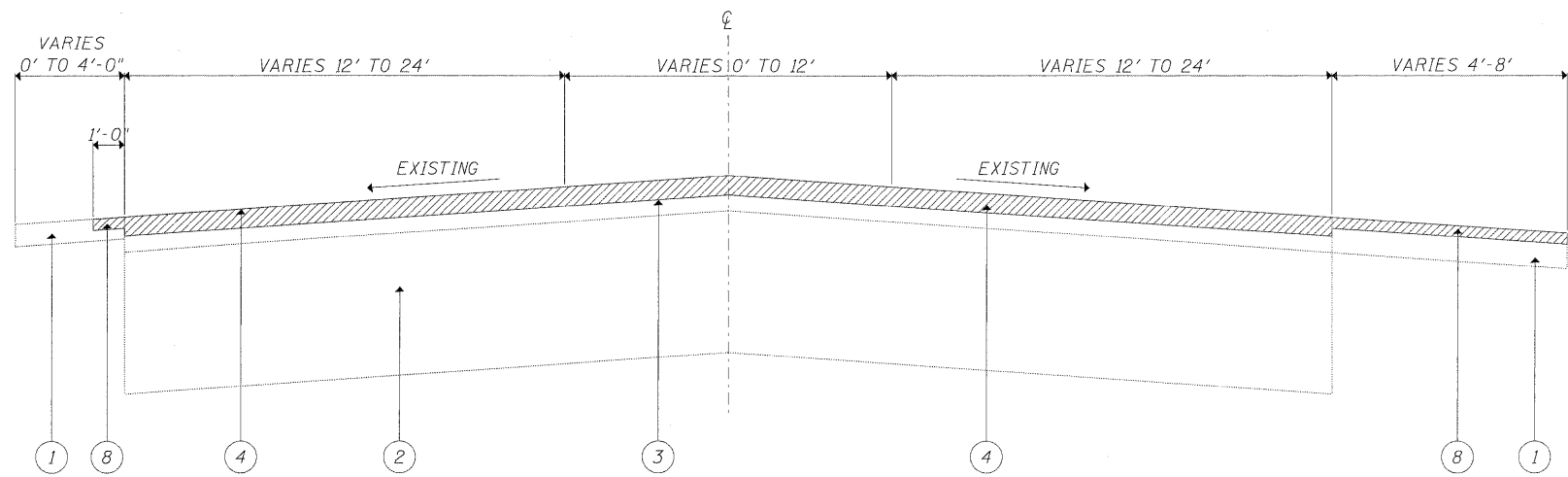

EXISTING TYPICAL SECTION

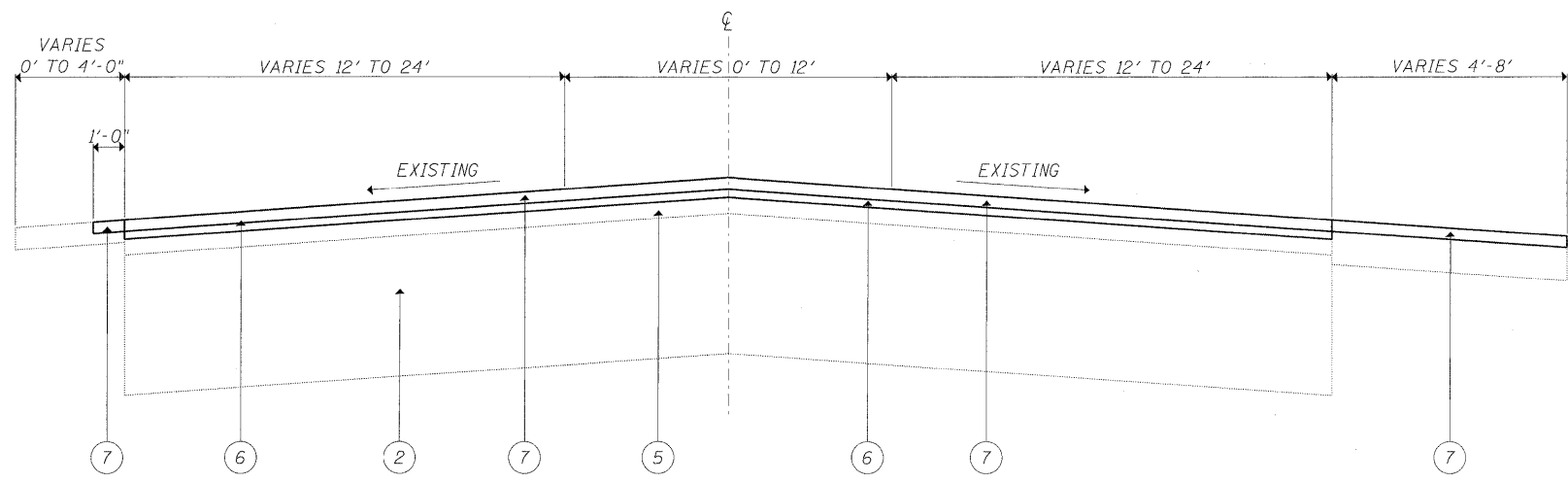

PROPOSED TYPICAL SECTION



PROPOSED TYPICAL SECTION W/ CURB AND GUTTERS

LEGEND

- ① EXISTING BITUMINOUS SHOULDER
- ② EXISTING P.C. CONCRETE PAVEMENT +/- 9"
- ③ EXISTING HMA SURFACE COURSE +/- 4"
- ③A EXISTING CONCRETE CURB AND GUTTER
- ④ PROPOSED HMA SURFACE REMOVAL (2 1/4")
- ⑤ HMA MATERIAL AFTER MILLING, +/- 2"
- ⑥ PROPOSED POLYMERIZED LEVELING BINDER (MACHINE METHOD) IL-4.75, N50 (3/4")
- ⑦ PROPOSED HMA SURFACE COURSE, MIX "D", N70 (1 1/2")
- ⑧ PROPOSED HMA SURFACE REMOVAL (1 1/2")
- ⑨ PROPOSED CONCRETE CURB AND GUTTER

HOT-MIX ASPHALT MIXTURE REQUIREMENTS		
MIXTURE TYPE	AC/PG	DESIGN AIR VOIDS
HMA SURFACE COURSE, MIX D, N70. (IL-9.5 mm)	PG 64-22	4% @ 70 GYR
POLYMERIZED LEVELING BINDER (MACHINE METHOD), IL-4.75, N50	SBS-SBR PG 76-28/22	4% @ 50 GYR
CLASS D PATCHES (HMA BINDER IL 19 mm)	PG 64-22*	4% @ 70 GYR
HMA REPLACEMENT OVER PATCHES (HMA BINDER IL 19 mm)	PG 64-22*	4% @ 70 GYR
DRIVEWAY PAVEMENT REMOVAL AND REPLACEMENT	PG 64-22*	4% @ 50 GYR

NOTE:  
 THE UNIT WEIGHT USED TO CALCULATE ALL HMA SURFACE COURSE MIXTURES IS 112 LSB/SQYD/IN.  
 \*WHEN RAP EXCEEDS 20%. THE NEW ASPHALT BINDER IN THE MIX SHALL BE PG 58-22  
 THE CONTRACTOR SHALL PATCH FIRST BEFORE MILLING  
 SHOULDER WIDENING GREATER THAN 4' AT VARIOUS LOCATIONS WITHIN THE LIMITS OF IMPROVEMENT

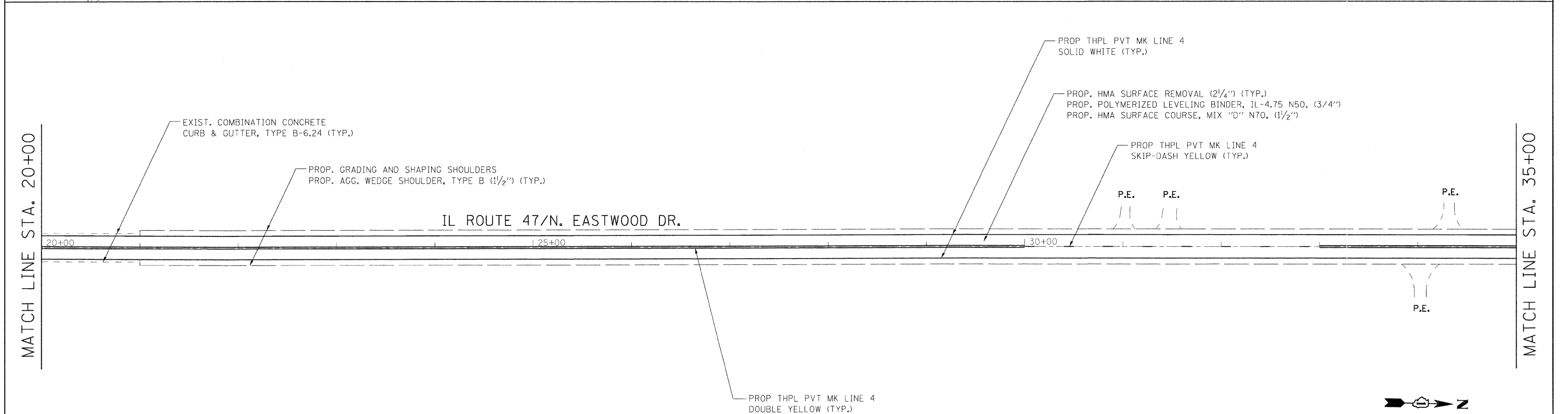
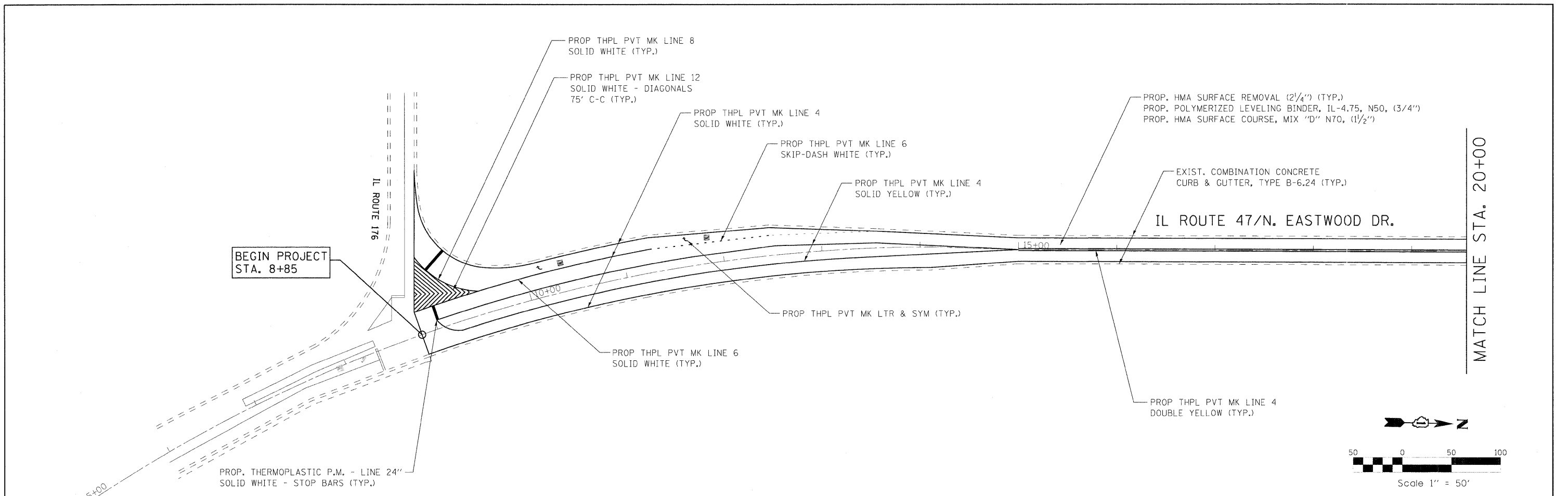

**GENERAL NOTES:**

- HOT-MIX ASPHALT SURFACE REMOVAL - BUTT JOINT SHALL BE PLACED AT THE FINAL 30' OF RESURFACING LIMITS OF MAINLINE AND SIDEROADS, UNLESS OTHERWISE SPECIFIED OR DIRECTED BY THE ENGINEER.

FILE NAME =	USER NAME = #USER#	DESIGNED - ST	REVISED -	<b>STATE OF ILLINOIS DEPARTMENT OF TRANSPORTATION</b>	<b>ROADWAY AND PAVEMENT MARKING PLAN IL ROUTE 47 FROM IL ROUTE 176 TO IL ROUTE 120</b>			F.A.P. RTE.	SECTION	COUNTY	TOTAL SHEETS	SHEET NO.
#FILE#		DRAWN - ST	REVISED -		SCALE: 1"=50'	SHEET NO. 6 OF 37 SHEETS	STA. 8+85 TO STA. 35+00	326	105 RS-9	McHENRY	37	6
		CHECKED - FML	REVISED -					D-91-603-09		CONTRACT NO. 60H33		
		DATE - 04/2009	REVISED -					FED. ROAD DIST. NO. - ILLINOIS FED. AID PROJECT				

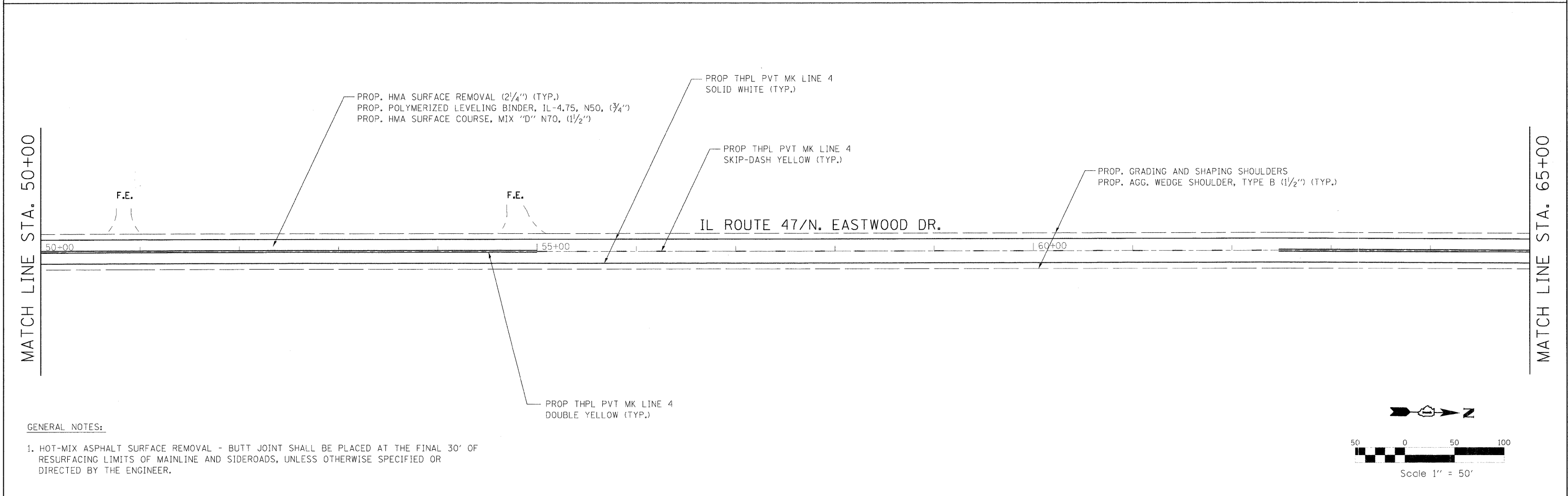
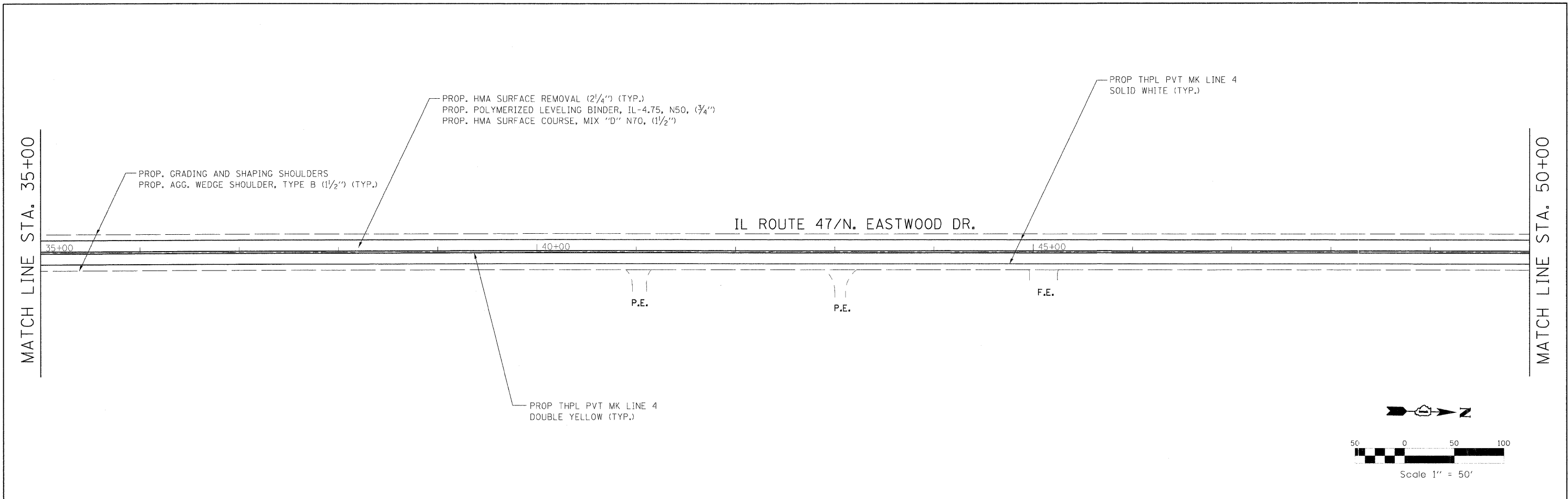

**GENERAL NOTES:**

1. HOT-MIX ASPHALT SURFACE REMOVAL - BUTT JOINT SHALL BE PLACED AT THE FINAL 30' OF RESURFACING LIMITS OF MAINLINE AND SIDEROADS, UNLESS OTHERWISE SPECIFIED OR DIRECTED BY THE ENGINEER.

FILE NAME = #FILE#	USER NAME = #USER#	DESIGNED - ST	REVISED -	<b>STATE OF ILLINOIS DEPARTMENT OF TRANSPORTATION</b>	<b>ROADWAY AND PAVEMENT MARKING PLAN IL ROUTE 47 FROM IL ROUTE 176 TO IL ROUTE 120</b>			F.A.P. RTE. 326	SECTION 105 RS-9	COUNTY McHENRY	TOTAL SHEETS 37	SHEET NO. 7	
	PLDT SCALE = #SCALE#	CHECKED - FML	REVISED -		SCALE: 1"=50'	SHEET NO. 7 OF 37 SHEETS	STA. 35+00 TO STA. 65+00	<b>D-91-603-09</b>					
	PLDT DATE = #DATE#	DATE - 04/2009	REVISED -		FED. ROAD DIST. NO. [ILLINOIS] FED. AID PROJECT								
	CONTRACT NO. 60H33												

MATCH LINE STA. 65+00

MATCH LINE STA. 80+00

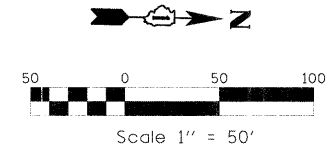
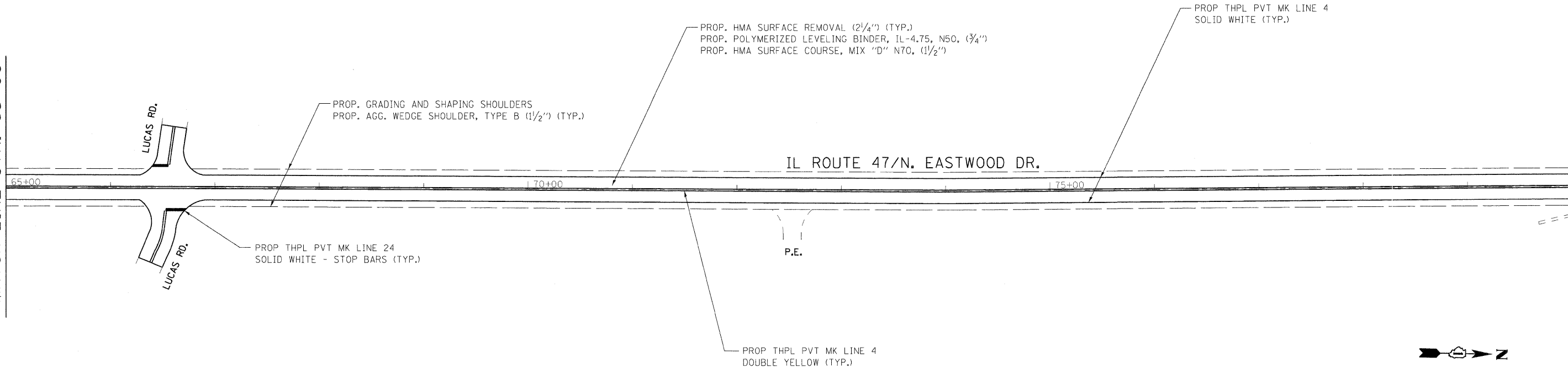

MATCH LINE STA. 80+00

MATCH LINE STA. 95+00

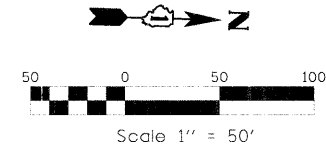
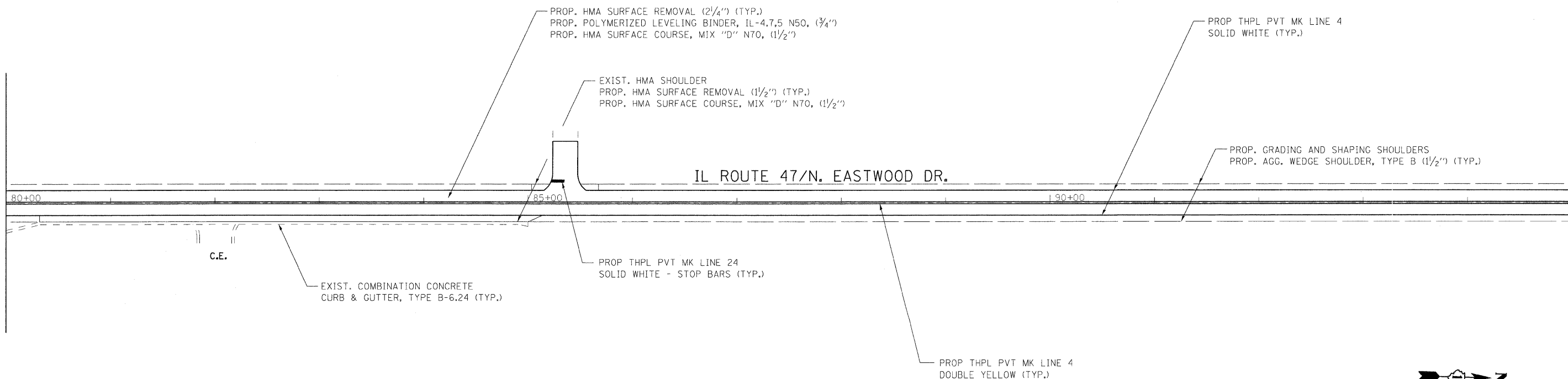

GENERAL NOTES:

- HOT-MIX ASPHALT SURFACE REMOVAL - BUTT JOINT SHALL BE PLACED AT THE FINAL 30' OF RESURFACING LIMITS OF MAINLINE AND SIDEROADS, UNLESS OTHERWISE SPECIFIED OR DIRECTED BY THE ENGINEER.

FILE NAME =	USER NAME = \$USER\$	DESIGNED - ST	REVISED -	<b>STATE OF ILLINOIS DEPARTMENT OF TRANSPORTATION</b>	<b>ROADWAY AND PAVEMENT MARKING PLAN IL ROUTE 47 FROM IL ROUTE 176 TO IL ROUTE 120</b>			F.A.P. RTE.	SECTION	COUNTY	TOTAL SHEETS	SHEET NO.
\$FILEL\$		DRAWN - ST	REVISED -		326	105 RS-9	McHENRY	37	8			
		CHECKED - FML	REVISED -		D-91-603-09			CONTRACT NO. 60H33				
		DATE - 04/2009	REVISED -		SCALE: 1"=50'	SHEET NO. 8 OF 37 SHEETS	STA. 65+00 TO STA. 95+00	FED. ROAD DIST. NO. [ILLINOIS] FED. AID PROJECT				



MATCH LINE STA. 95+00

MATCH LINE STA. 110+00

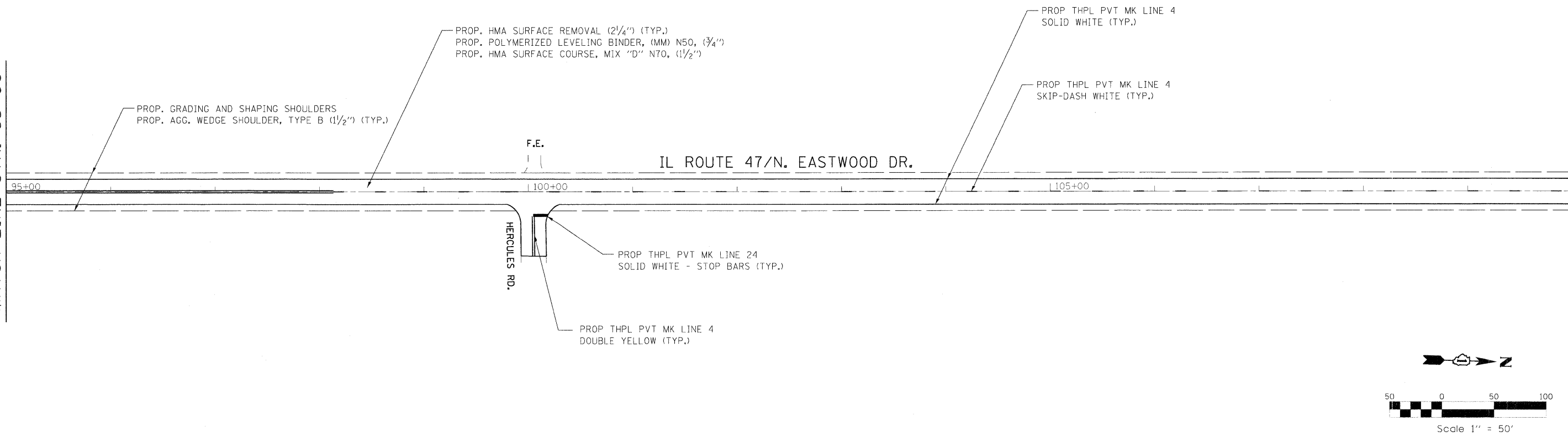

MATCH LINE STA. 110+00

MATCH LINE STA. 125+00

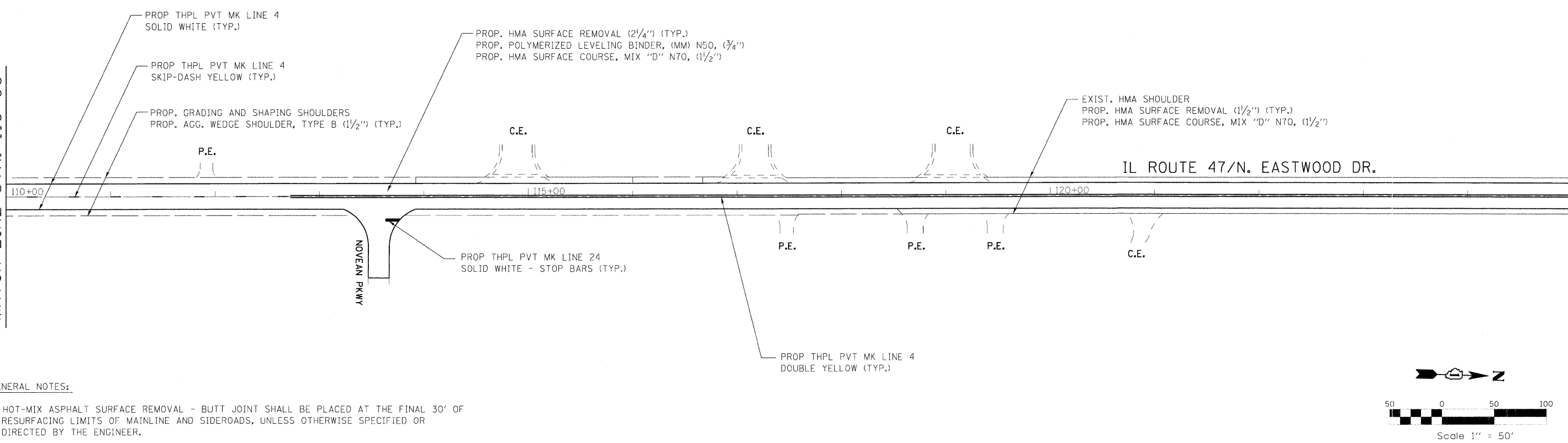

GENERAL NOTES:

- HOT-MIX ASPHALT SURFACE REMOVAL - BUTT JOINT SHALL BE PLACED AT THE FINAL 30' OF RESURFACING LIMITS OF MAINLINE AND SIDEROADS, UNLESS OTHERWISE SPECIFIED OR DIRECTED BY THE ENGINEER.

FILE NAME =	USER NAME = #USER#	DESIGNED - ST	REVISED -	<b>STATE OF ILLINOIS DEPARTMENT OF TRANSPORTATION</b>	<b>ROADWAY AND PAVEMENT MARKING PLAN IL ROUTE 47 FROM IL ROUTE 176 TO IL ROUTE 120</b>	F.A.P. RTE.	SECTION	COUNTY	TOTAL SHEETS	SHEET NO.	
#FILEL#		DRAWN - ST	REVISED -			326	105 RS-9	McHENRY	37	9	
		CHECKED - FML	REVISED -			D-91-603-09		CONTRACT NO. 60H33			
		DATE - 04/2009	REVISED -			SCALE: 1"=50'		SHEET NO. 9 OF 37 SHEETS		STA. 95+00 TO STA. 125+00	
						FED. ROAD DIST. NO. ILLINOIS FED. AID PROJECT					

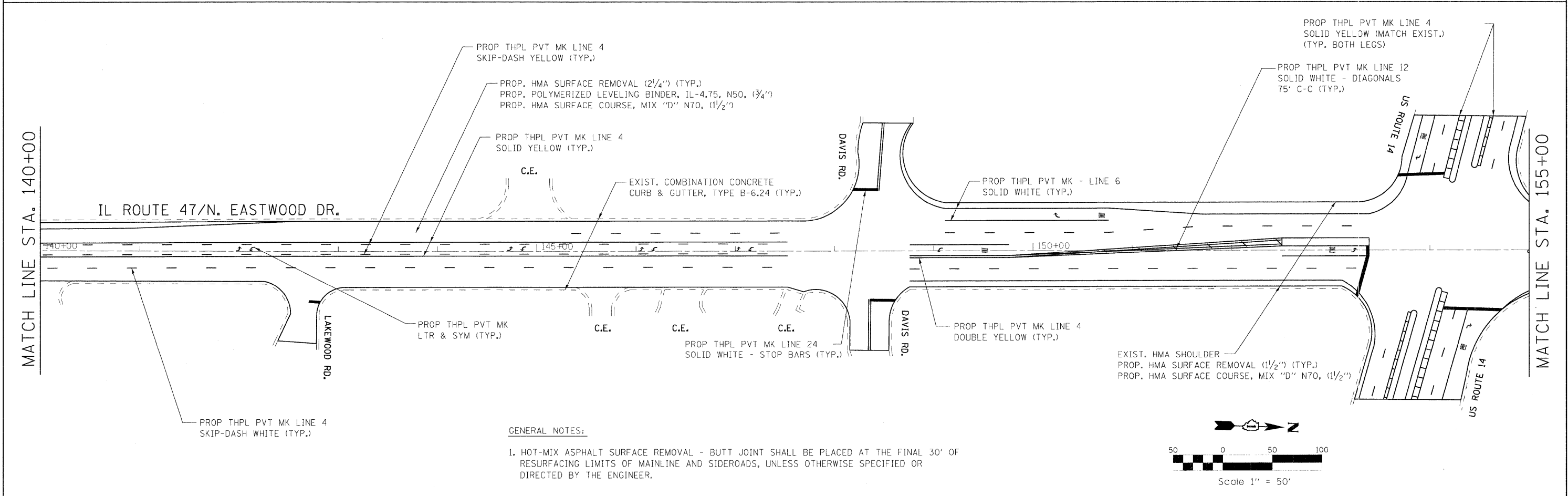
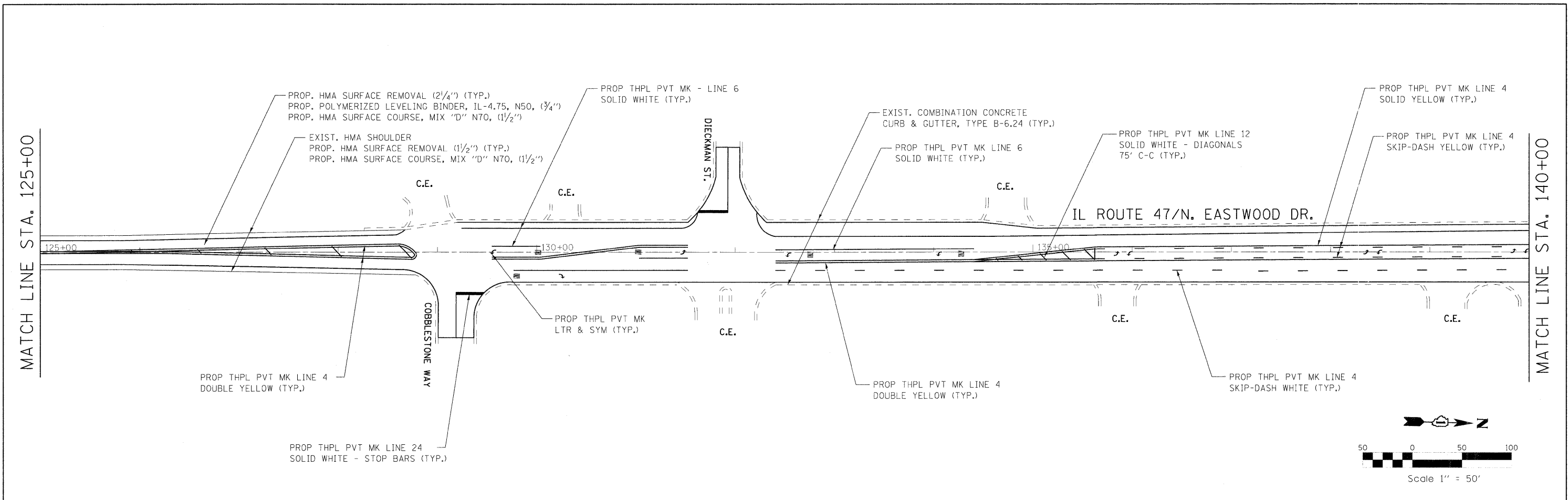

**GENERAL NOTES:**

- HOT-MIX ASPHALT SURFACE REMOVAL - BUTT JOINT SHALL BE PLACED AT THE FINAL 30' OF RESURFACING LIMITS OF MAINLINE AND SIDEROADS, UNLESS OTHERWISE SPECIFIED OR DIRECTED BY THE ENGINEER.

FILE NAME =	USER NAME = #USER#	DESIGNED - ST	REVISED -	<b>STATE OF ILLINOIS DEPARTMENT OF TRANSPORTATION</b>	<b>ROADWAY AND PAVEMENT MARKING PLAN IL ROUTE 47 FROM IL ROUTE 176 TO IL ROUTE 120</b>	F.A.P. RTE.	SECTION	COUNTY	TOTAL SHEETS	SHEET NO.	
#FILE#		DRAWN - ST	REVISED -			326	105 RS-9	McHENRY	37	10	
	PLOT SCALE = #SCALE#	CHECKED - FML	REVISED -			D-91-603-09		CONTRACT NO. 60H33			
	PLOT DATE = #DATE#	DATE - 04/2009	REVISED -			SCALE: 1"=50'	SHEET NO. 10 OF 37 SHEETS	STA. 125+00 TO STA. 155+00	FED. ROAD DIST. NO. [ ] ILLINOIS FED. AID PROJECT		

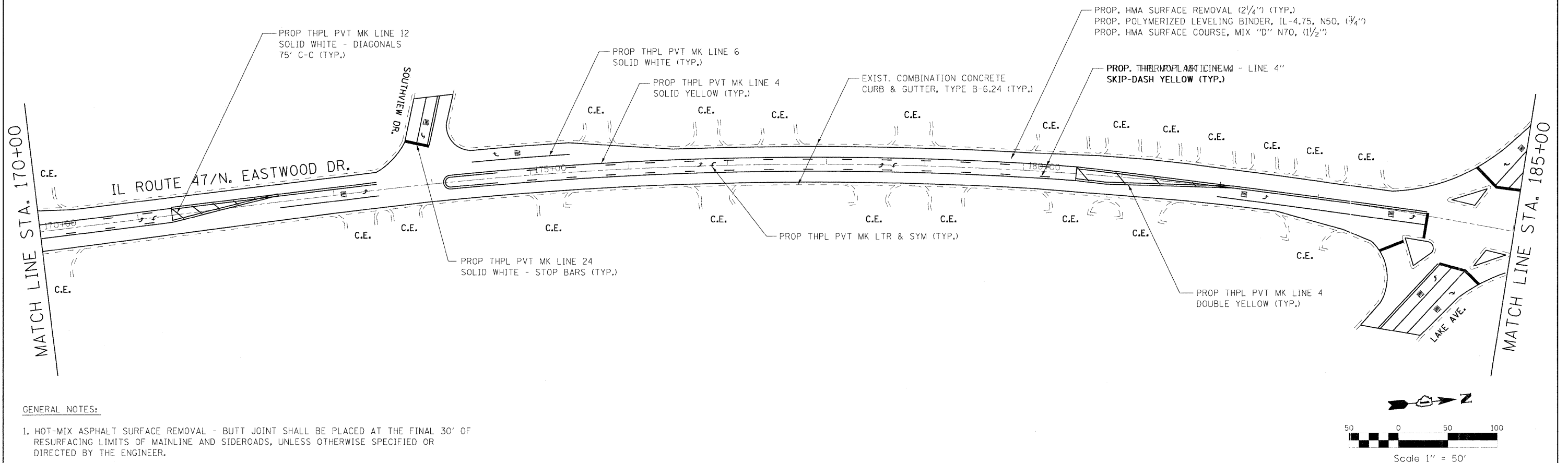
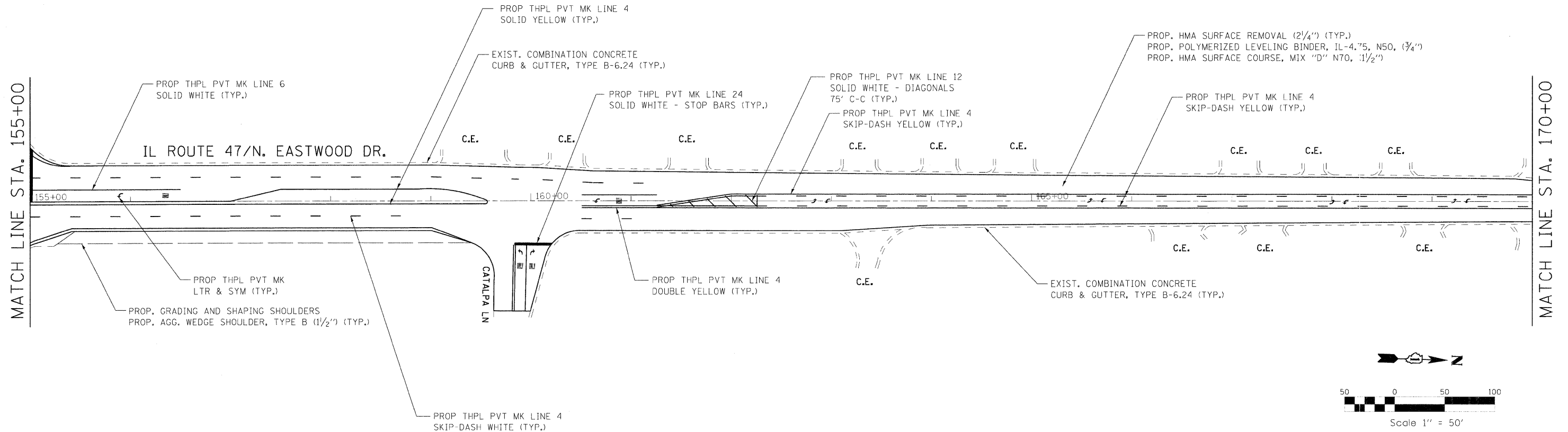

**GENERAL NOTES:**

- HOT-MIX ASPHALT SURFACE REMOVAL - BUTT JOINT SHALL BE PLACED AT THE FINAL 30' OF RESURFACING LIMITS OF MAINLINE AND SIDEROADS, UNLESS OTHERWISE SPECIFIED OR DIRECTED BY THE ENGINEER.

FILE NAME =	USER NAME = #USER#	DESIGNED - ST	REVISED -	<b>STATE OF ILLINOIS DEPARTMENT OF TRANSPORTATION</b>	<b>ROADWAY AND PAVEMENT MARKING PLAN IL ROUTE 47 FROM IL ROUTE 176 TO IL ROUTE 120</b>			F.A.P. RTE. 326	SECTION 105 RS-9	COUNTY McHENRY	TOTAL SHEETS 37	SHEET NO. 11
#FILE#		DRAWN - ST	REVISED -		SCALE: 1"=50'	SHEET NO. 11 OF 37 SHEETS	STA. 155+00 TO STA. 185+00	D-91-603-09 CONTRACT NO. 60H33				
		CHECKED - FML	REVISED -		FED. ROAD DIST. NO. [ILLINOIS] FED. AID PROJECT							
		DATE - 04/2009	REVISED -									

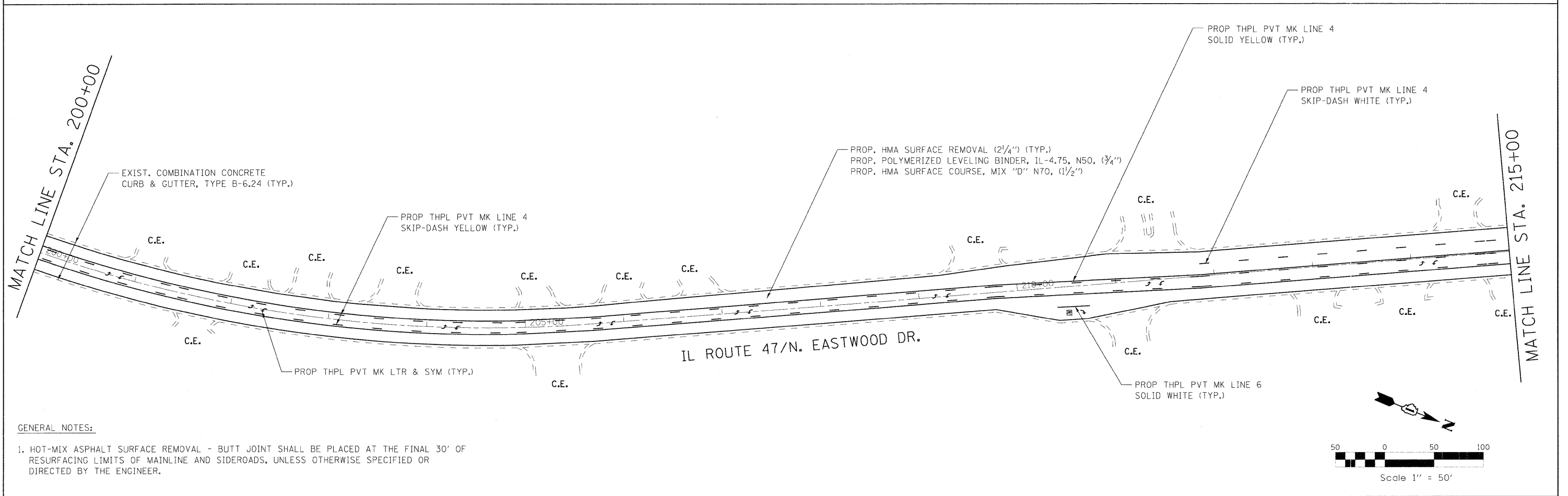
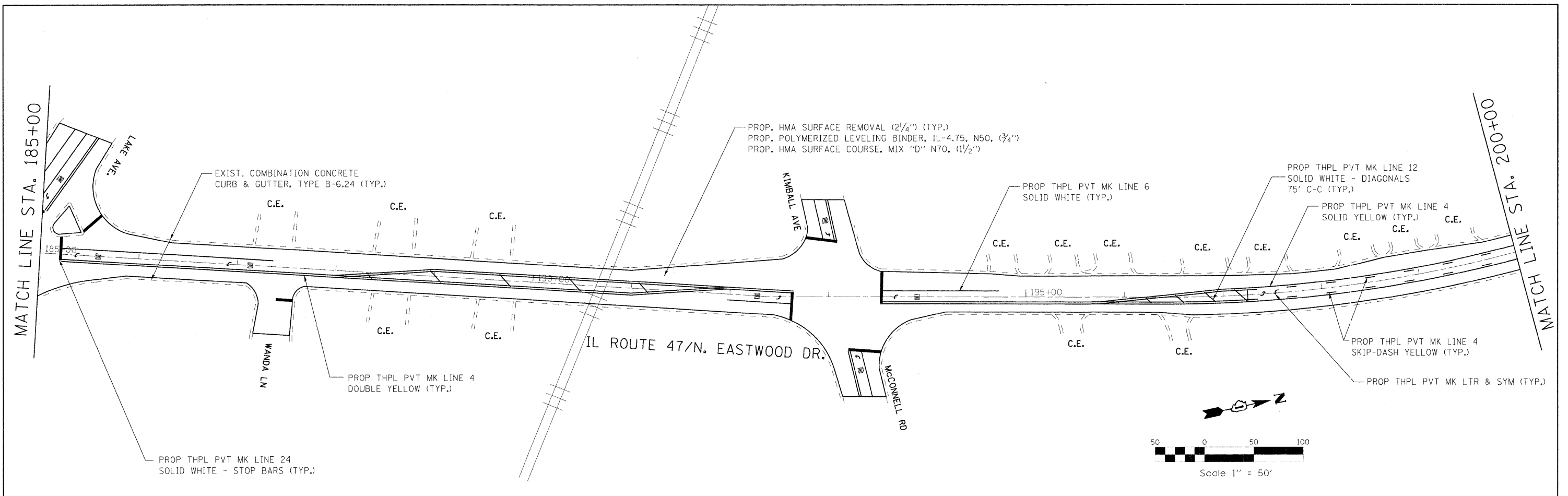

**GENERAL NOTES:**

- HOT-MIX ASPHALT SURFACE REMOVAL - BUTT JOINT SHALL BE PLACED AT THE FINAL 30' OF RESURFACING LIMITS OF MAINLINE AND SIDEROADS, UNLESS OTHERWISE SPECIFIED OR DIRECTED BY THE ENGINEER.

FILE NAME =	USER NAME = #USER#	DESIGNED - ST	REVISED -	<b>STATE OF ILLINOIS DEPARTMENT OF TRANSPORTATION</b>	<b>ROADWAY AND PAVEMENT MARKING PLAN IL ROUTE 47 FROM IL ROUTE 176 TO IL ROUTE 120</b>	F.A.P. RTE.	SECTION	COUNTY	TOTAL SHEETS	SHEET NO.	
#FILE#		DRAWN - ST	REVISED -			326	105 RS-9	McHENRY	37	12	
		CHECKED - FML	REVISED -			<b>D-91-603-09</b>		<b>CONTRACT NO. 60H33</b>			
		DATE - 04/2009	REVISED -			SCALE: 1"=50'	SHEET NO. 12 OF 37 SHEETS	STA. 185+00 TO STA. 215+00	FED. ROAD DIST. NO. ILLINOIS FED. AID PROJECT		

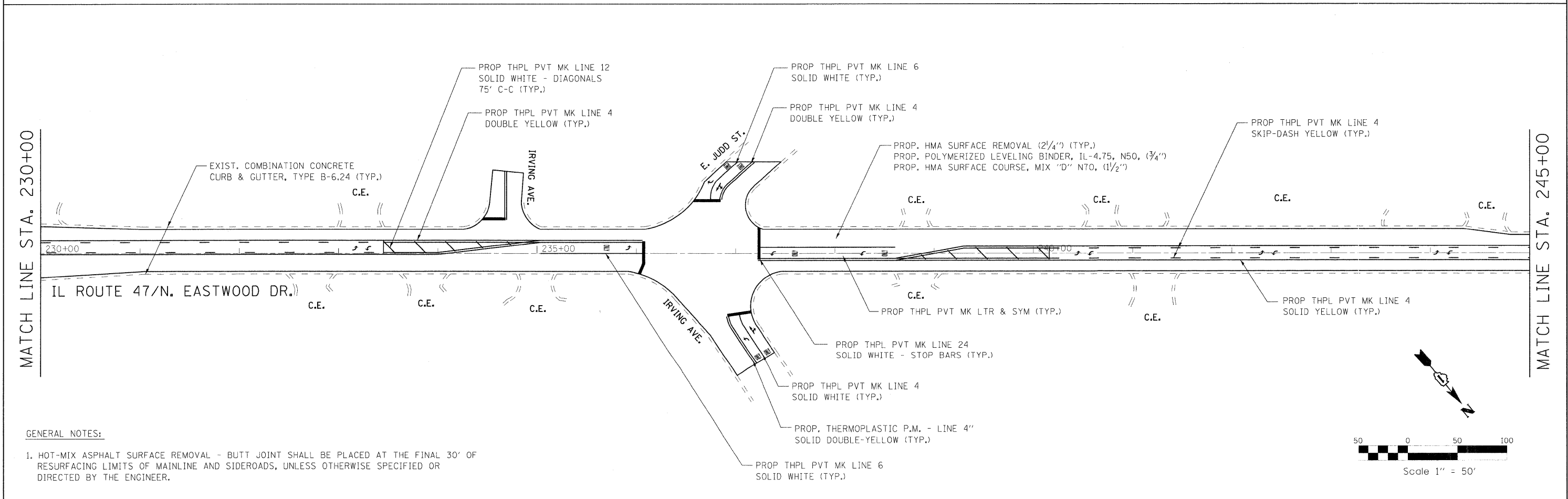
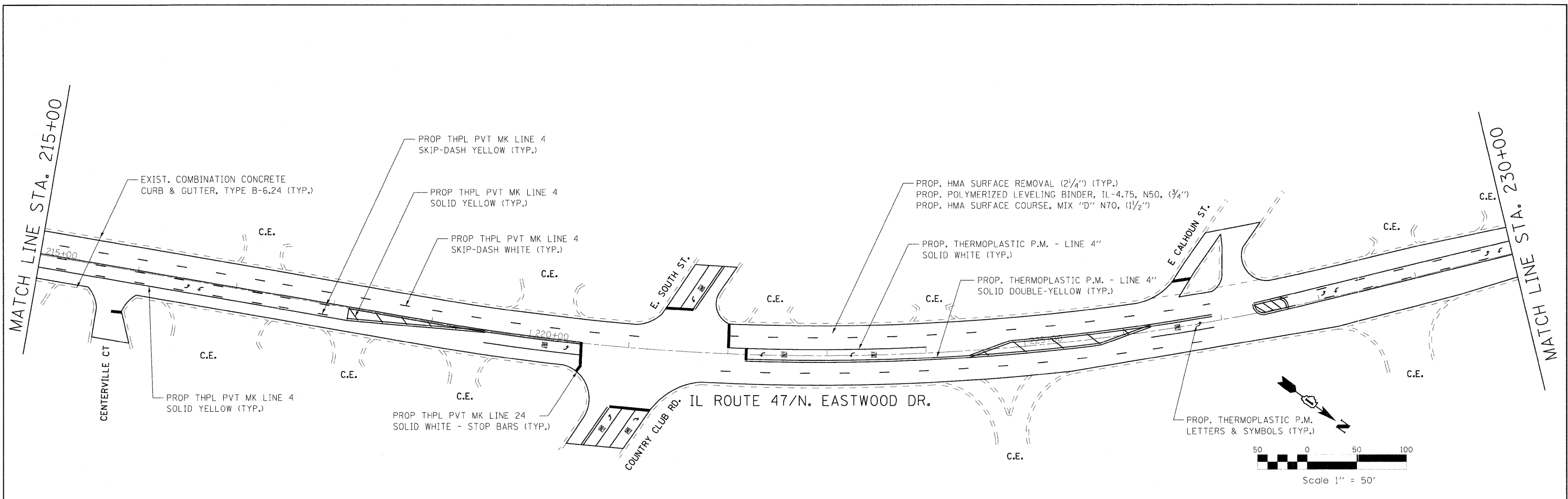

**GENERAL NOTES:**

- HOT-MIX ASPHALT SURFACE REMOVAL - BUTT JOINT SHALL BE PLACED AT THE FINAL 30' OF RESURFACING LIMITS OF MAINLINE AND SIDEROADS, UNLESS OTHERWISE SPECIFIED OR DIRECTED BY THE ENGINEER.

FILE NAME = #FILEL#	USER NAME = #USER#	DESIGNED - ST	REVISED -	<b>STATE OF ILLINOIS DEPARTMENT OF TRANSPORTATION</b>	<b>ROADWAY AND PAVEMENT MARKING PLAN IL ROUTE 47 FROM IL ROUTE 176 TO IL ROUTE 120</b>	F.A.P. RTE. 326	SECTION 105 RS-9	COUNTY McHENRY	TOTAL SHEETS 37	SHEET NO. 13		
	PLOT SCALE = #SCALE#	DRAWN - ST	REVISED -			D-91-603-09		CONTRACT NO. 60H33				
	PLOT DATE = #DATE#	CHECKED - FML	REVISED -			SCALE: 1"=50'		SHEET NO. 13 OF 37 SHEETS		STA. 215+00 TO STA. 245+00		
		DATE - 04/2009	REVISED -			FED. ROAD DIST. NO. ILLINOIS FED. AID PROJECT						

GENERAL NOTES:

1. HOT-MIX ASPHALT SURFACE REMOVAL - BUTT JOINT SHALL BE PLACED AT THE FINAL 30' OF RESURFACING LIMITS OF MAINLINE AND SIDEROADS, UNLESS OTHERWISE SPECIFIED OR DIRECTED BY THE ENGINEER.

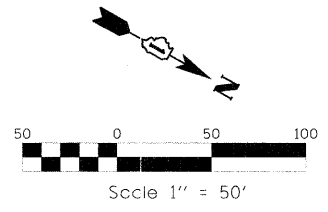
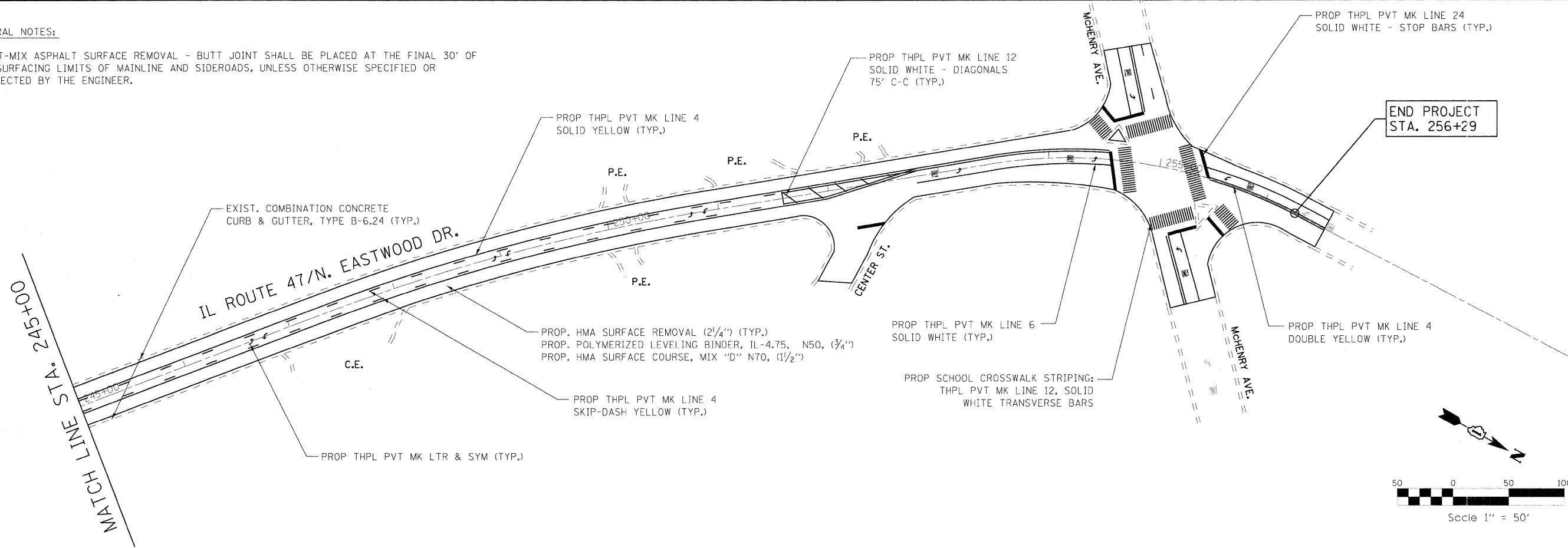

FILE NAME =	USER NAME = *USER*	DESIGNED - ST	REVISED -	<b>STATE OF ILLINOIS DEPARTMENT OF TRANSPORTATION</b>	<b>ROADWAY AND PAVEMENT MARKING PLAN IL ROUTE 47 FROM IL ROUTE 176 TO IL ROUTE 120</b>	F.A.P. RTE:	SECTION	COUNTY	TOTAL SHEETS	SHEET NO.	
*FILE#		DRAWN - ST	REVISED -			326	105 RS-9	McHENRY	37	14	
		CHECKED - FML	REVISED -			D-91-603-09		CONTRACT NO. 60H33			
		DATE - 04/2009	REVISED -			SCALE: 1"=50'	SHEET NO. 14 OF 37 SHEETS	STA. 245+00 TO STA. 256+29	FED. ROAD DIST. NO. ILLINOIS FED. AID PROJECT		

NOTES:

1. THIS PLAN IS FOR THE SOLE PURPOSE OF DETECTOR LOOP REPLACEMENTS ONLY.
2. REPLACE ALL DETECTOR LOOPS AS SHOWN WITHIN THE RESURFACING LIMITS.
3. ALL DETECTOR LOOPS ARE 6' X 6' UNLESS OTHERWISE SHOWN.
4. AS-BUILT PLAN SHEETS PROVIDED BY IDOT HAVE BEEN INCLUDED FOR BIDDING PURPOSES ONLY, AND DO NOT NECESSARILY REFLECT ACTUAL FIELD CONDITIONS. PROPOSED DETECTOR LOOPS SHALL BE REPLACED AT ALL EXISTING LOCATIONS WITHIN THE PROJECT LIMITS, IN ACCORDANCE WITH STANDARD TS-07, SPECIAL PROVISIONS, AND AS DIRECTED BY THE ENGINEER.

TRAFFIC SIGNAL LEGEND

	PROPOSED	EXISTING
DETECTOR LOOP		
SIGNAL HEAD		
G.S. CONDUIT IN TRENCH OR PUSHED		
SIGNAL HEAD WITH BACKPLATE		
RACEWAY FOR MAGNETIC DETECTOR, TYPE I OR II		
VEHICLE DETECTOR, NON-COMPENSATED MAGNETIC TYPE		

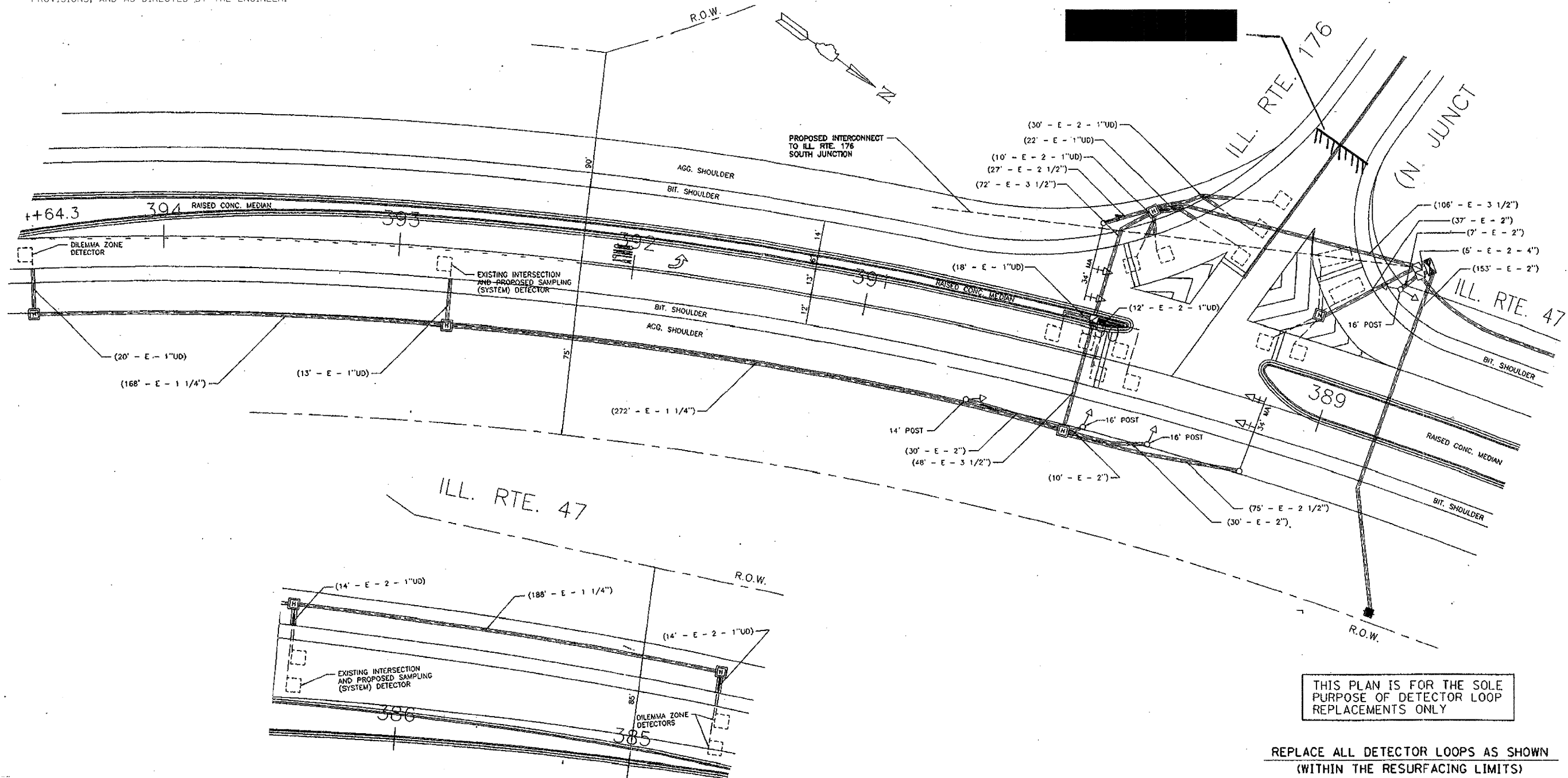

THIS PLAN IS FOR THE SOLE PURPOSE OF DETECTOR LOOP REPLACEMENTS ONLY

REPLACE ALL DETECTOR LOOPS AS SHOWN (WITHIN THE RESURFACING LIMITS)

FILE NAME =	USER NAME = \$USER\$	DESIGNED -	REVISED -	<b>STATE OF ILLINOIS DEPARTMENT OF TRANSPORTATION</b>	<b>DETECTOR LOOP PLAN - IL ROUTE 176 (NORTH JCT.) IL ROUTE 47 FROM IL ROUTE 176 TO IL ROUTE 120</b>	F.A.P. RTE.	SECTION	COUNTY	TOTAL SHEETS	SHEET NO.	
\$FILEL\$		DRAWN -	REVISED -			326	105 RS-9	McHENRY	37	15	
		CHECKED -	REVISED -			D-91-603-09		CONTRACT NO. 60H33			
		DATE = 4/2009	REVISED -			SCALE: NONE	SHEET NO. 15 OF 37 SHEETS	STA. 8+85 TO STA. 256+29	FED. ROAD DIST. NO. [ILLINOIS] FED. AID PROJECT		

**TRAFFIC SIGNAL LEGEND**

	PROPOSED	EXISTING
DETECTOR LOOP		
SIGNAL HEAD		
G.S. CONDUIT IN TRENCH OR PUSHED		
SIGNAL HEAD WITH BACKPLATE		
RACEWAY FOR MAGNETIC DETECTOR, TYPE I OR II		
VEHICLE DETECTOR, NON-COMPENSATED MAGNETIC TYPE		

**NOTES:**

1. THIS PLAN IS FOR THE SOLE PURPOSE OF DETECTOR LOOP REPLACEMENTS ONLY.
2. REPLACE ALL DETECTOR LOOPS AS SHOWN WITHIN THE RESURFACING LIMITS.
3. ALL DETECTOR LOOPS ARE 6' X 6' UNLESS OTHERWISE SHOWN.
4. AS-BUILT PLAN SHEETS PROVIDED BY IDOT HAVE BEEN INCLUDED FOR BIDDING PURPOSES ONLY, AND DO NOT NECESSARILY REFLECT ACTUAL FIELD CONDITIONS. PROPOSED DETECTOR LOOPS SHALL BE REPLACED AT ALL EXISTING LOCATIONS WITHIN THE PROJECT LIMITS, IN ACCORDANCE WITH STANDARD TS-07, SPECIAL PROVISIONS, AND AS DIRECTED BY THE ENGINEER.

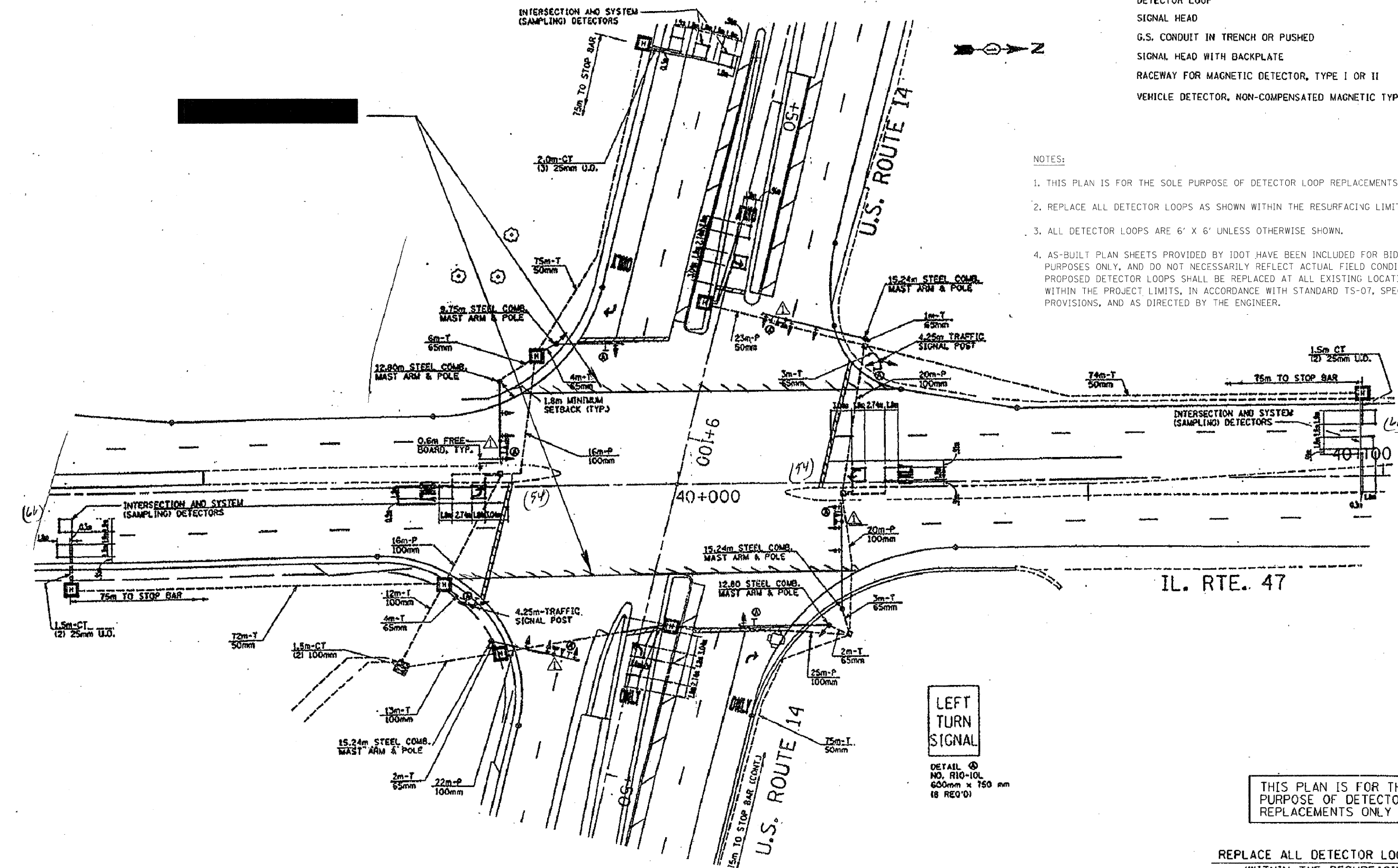

THIS PLAN IS FOR THE SOLE PURPOSE OF DETECTOR LOOP REPLACEMENTS ONLY

REPLACE ALL DETECTOR LOOPS AS SHOWN (WITHIN THE RESURFACING LIMITS)

FILE NAME =	USER NAME = #USER#	DESIGNED -	REVISED -	<b>STATE OF ILLINOIS DEPARTMENT OF TRANSPORTATION</b>	<b>DETECTOR LOOP PLAN - US ROUTE 14 IL ROUTE 47 FROM IL ROUTE 176 TO IL ROUTE 120</b>			F.A.P. RTE.:	SECTION	COUNTY	TOTAL SHEETS	SHEET NO.
#FILE#		DRAWN -	REVISED -		326	105 RS-9	McHENRY	37	16			
		CHECKED -	REVISED -		D-91-603-09			CONTRACT NO. 60H33				
		DATE - 4/2009	REVISED -		SCALE: NONE	SHEET NO. 16 OF 37 SHEETS	STA. 8+85 TO STA. 256+29	FED. ROAD DIST. NO. ILLINOIS FED. AID PROJECT				



NOTES:

1. THIS PLAN IS FOR THE SOLE PURPOSE OF DETECTOR LOOP REPLACEMENTS ONLY.
2. REPLACE ALL DETECTOR LOOPS AS SHOWN WITHIN THE RESURFACING LIMITS.
3. ALL DETECTOR LOOPS ARE 6' X 6' UNLESS OTHERWISE SHOWN.
4. AS-BUILT PLAN SHEETS PROVIDED BY IDOT HAVE BEEN INCLUDED FOR BIDDING PURPOSES ONLY, AND DO NOT NECESSARILY REFLECT ACTUAL FIELD CONDITIONS. PROPOSED DETECTOR LOOPS SHALL BE REPLACED AT ALL EXISTING LOCATIONS WITHIN THE PROJECT LIMITS, IN ACCORDANCE WITH STANDARD TS-07, SPECIAL PROVISIONS, AND AS DIRECTED BY THE ENGINEER.

TRAFFIC SIGNAL LEGEND

	PROPOSED	EXISTING
DETECTOR LOOP		
SIGNAL HEAD		
C.S. CONDUIT IN TRENCH OR PUSHED		
SIGNAL HEAD WITH BACKPLATE		
RACEWAY FOR MAGNETIC DETECTOR, TYPE I OR II		
VEHICLE DETECTOR, NON-COMPENSATED MAGNETIC TYPE		

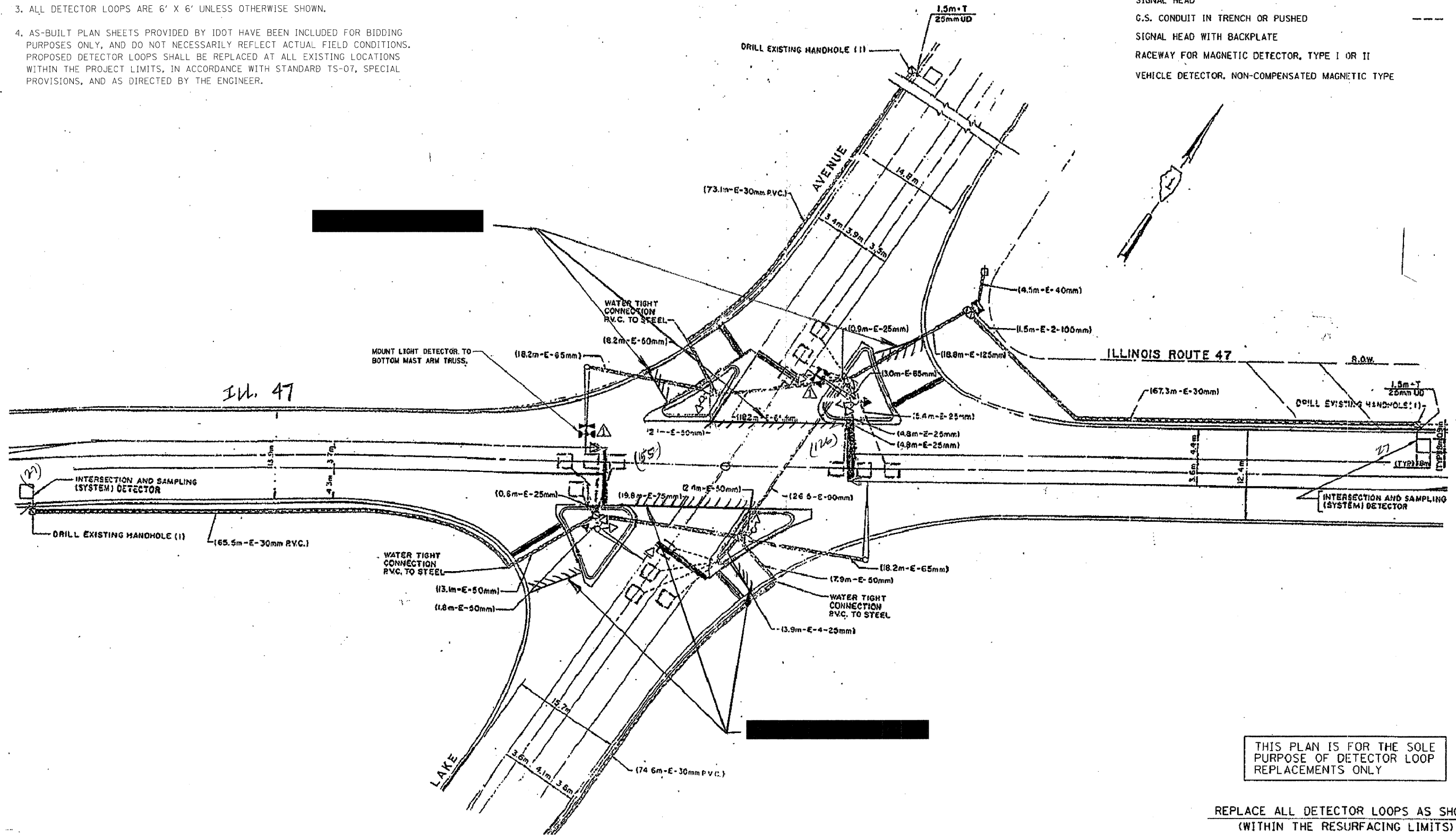

THIS PLAN IS FOR THE SOLE PURPOSE OF DETECTOR LOOP REPLACEMENTS ONLY

REPLACE ALL DETECTOR LOOPS AS SHOWN (WITHIN THE RESURFACING LIMITS)

FILE NAME = #FILE#	USER NAME = #USER#	DESIGNED - DRAWN -	REVISED - REVISED -	<b>STATE OF ILLINOIS DEPARTMENT OF TRANSPORTATION</b>	<b>DETECTOR LOOP PLAN - LAKE AVENUE IL ROUTE 47 FROM IL ROUTE 176 TO IL ROUTE 120</b>		F.A.P. RTE. 326	SECTION 105 RS-9	COUNTY MCHENRY	TOTAL SHEETS 37	SHEET NO. 17	
		CHECKED -	REVISED -		SCALE: NONE	SHEET NO. 17 OF 37 SHEETS	STA. 8+85 TO STA. 256+29	D-91-603-09		CONTRACT NO. 60H33		
		DATE - 4/2009	REVISED -		FED. ROAD DIST. NO. [ILLINOIS] FED. AID PROJECT							



**NOTES:**

1. THIS PLAN IS FOR THE SOLE PURPOSE OF DETECTOR LOOP REPLACEMENTS ONLY.
2. REPLACE ALL DETECTOR LOOPS AS SHOWN WITHIN THE RESURFACING LIMITS.
3. ALL DETECTOR LOOPS ARE 6' X 6' UNLESS OTHERWISE SHOWN.
4. AS-BUILT PLAN SHEETS PROVIDED BY IDOT HAVE BEEN INCLUDED FOR BIDDING PURPOSES ONLY, AND DO NOT NECESSARILY REFLECT ACTUAL FIELD CONDITIONS. PROPOSED DETECTOR LOOPS SHALL BE REPLACED AT ALL EXISTING LOCATIONS WITHIN THE PROJECT LIMITS, IN ACCORDANCE WITH STANDARD TS-07, SPECIAL PROVISIONS, AND AS DIRECTED BY THE ENGINEER.

**TRAFFIC SIGNAL LEGEND**

	PROPOSED	EXISTING
DETECTOR LOOP		
SIGNAL HEAD		
G.S. CONDUIT IN TRENCH OR PUSHED		
SIGNAL HEAD WITH BACKPLATE		
RACEWAY FOR MAGNETIC DETECTOR, TYPE I OR II		
VEHICLE DETECTOR, NON-COMPENSATED MAGNETIC TYPE		

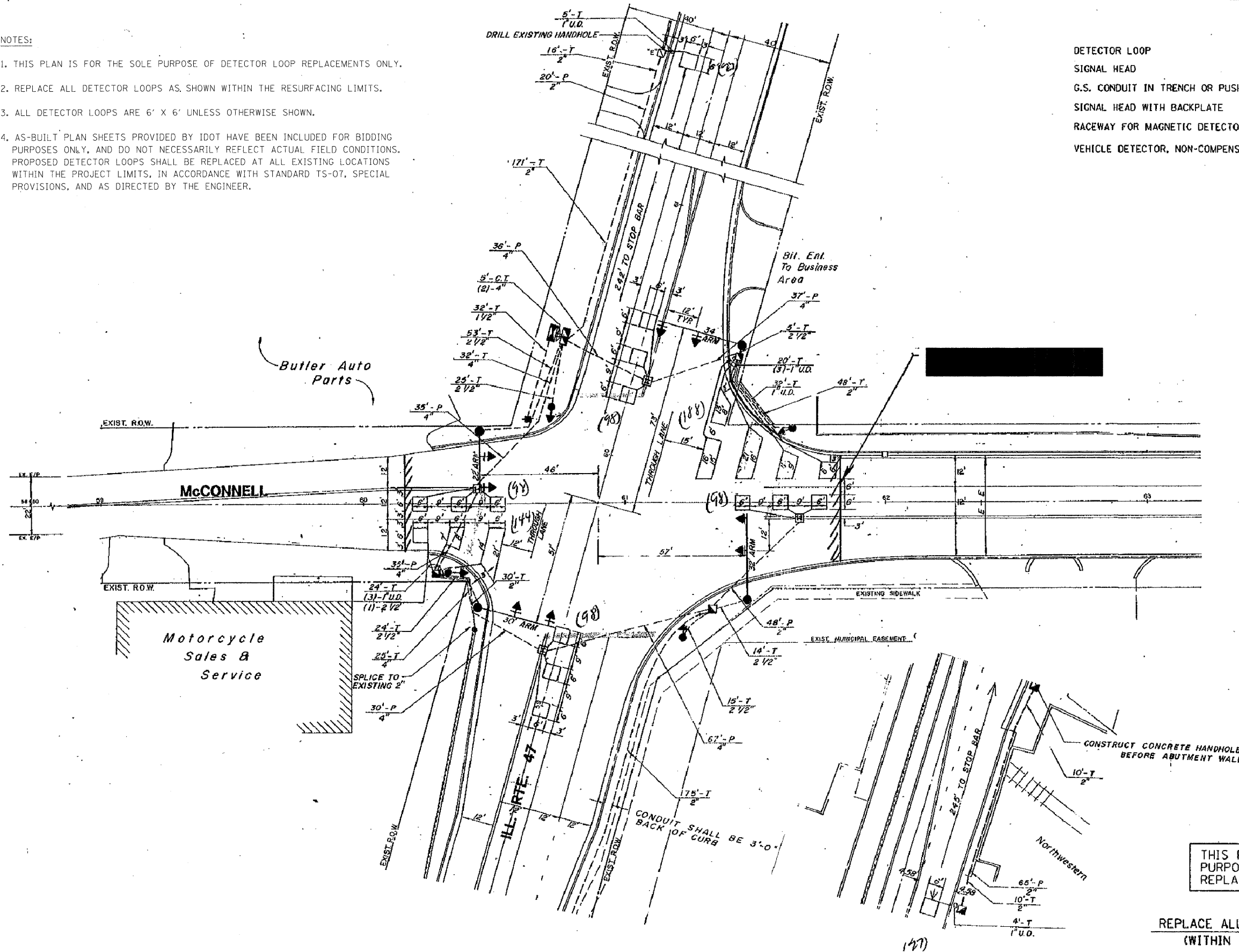

THIS PLAN IS FOR THE SOLE PURPOSE OF DETECTOR LOOP REPLACEMENTS ONLY

REPLACE ALL DETECTOR LOOPS AS SHOWN (WITHIN THE RESURFACING LIMITS)

FILE NAME =	USER NAME = \$USER\$	DESIGNED -	REVISED -	<b>STATE OF ILLINOIS DEPARTMENT OF TRANSPORTATION</b>	<b>DETECTOR LOOP PLAN - McCONNELL ROAD IL ROUTE 47 FROM IL ROUTE 176 TO IL ROUTE 120</b>	F.A.P. RTE.	SECTION	COUNTY	TOTAL SHEETS	SHEET NO.	
\$FILEL\$		DRAWN -	REVISED -			326	105 RS-9	McHENRY	37	18	
		CHECKED -	REVISED -			D-91-603-09		CONTRACT NO. 60H33			
		DATE - 4/2009	REVISED -			SCALE: NONE	SHEET NO. 18 OF 37 SHEETS	STA. 8+85 TO STA. 256+29	FED. ROAD DIST. NO. [ILLINOIS] FED. AID PROJECT		

**TRAFFIC SIGNAL LEGEND**

	PROPOSED	EXISTING
DETECTOR LOOP		
SIGNAL HEAD		
G.S. CONDUIT IN TRENCH OR PUSHED		
SIGNAL HEAD WITH BACKPLATE		
RACEWAY FOR MAGNETIC DETECTOR, TYPE I OR II		
VEHICLE DETECTOR, NON-COMPENSATED MAGNETIC TYPE		

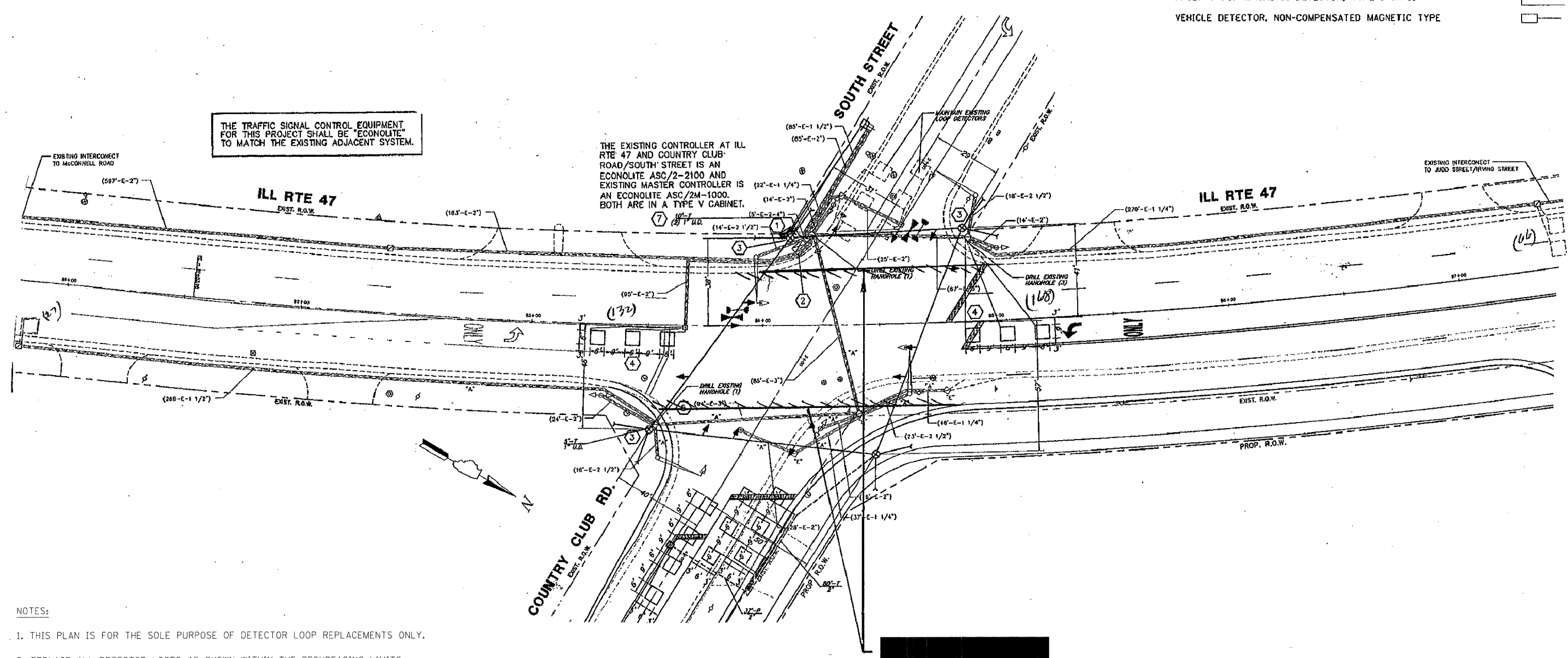

THE TRAFFIC SIGNAL CONTROL EQUIPMENT FOR THIS PROJECT SHALL BE "ECONOLITE" TO MATCH THE EXISTING ADJACENT SYSTEM.

THE EXISTING CONTROLLER AT ILL. RTE 47 AND COUNTRY CLUB ROAD/SOUTH STREET IS AN ECONOLITE ASC/2-2100 AND EXISTING MASTER CONTROLLER IS AN ECONOLITE ASC/2M-1000. BOTH ARE IN A TYPE V CABINET.

- NOTES:
1. THIS PLAN IS FOR THE SOLE PURPOSE OF DETECTOR LOOP REPLACEMENTS ONLY.
  2. REPLACE ALL DETECTOR LOOPS AS SHOWN WITHIN THE RESURFACING LIMITS.
  3. ALL DETECTOR LOOPS ARE 6' X 6' UNLESS OTHERWISE SHOWN.
  4. AS-BUILT PLAN SHEETS PROVIDED BY IDOT HAVE BEEN INCLUDED FOR BIDDING PURPOSES ONLY, AND DO NOT NECESSARILY REFLECT ACTUAL FIELD CONDITIONS. PROPOSED DETECTOR LOOPS SHALL BE REPLACED AT ALL EXISTING LOCATIONS WITHIN THE PROJECT LIMITS, IN ACCORDANCE WITH STANDARD TS-07, SPECIAL PROVISIONS, AND AS DIRECTED BY THE ENGINEER.

THIS PLAN IS FOR THE SOLE PURPOSE OF DETECTOR LOOP REPLACEMENTS ONLY

REPLACE ALL DETECTOR LOOPS AS SHOWN (WITHIN THE RESURFACING LIMITS)

FILE NAME =	USER NAME = #USER#	DESIGNED -	REVISED -	<b>STATE OF ILLINOIS DEPARTMENT OF TRANSPORTATION</b>	<b>DETECTOR LOOP PLAN - SOUTH STREET &amp; COUNTRY CLUB ROAD IL ROUTE 47 FROM IL ROUTE 176 TO IL ROUTE 120</b>	F.A.P. RTE.	SECTION	COUNTY	TOTAL SHEETS	SHEET NO.
#FILE#		DRAWN -	REVISED -			326	105 RS-9	McHENRY	37	19
		CHECKED -	REVISED -			D-91-603-09		CONTRACT NO. 60H33		
		DATE - 4/2009	REVISED -			SCALE: NONE	SHEET NO. 19 OF 37 SHEETS	STA. 8+85 TO STA. 256+29	FED. ROAD DIST. NO. [ILLINOIS] FED. AID PROJECT	

**TRAFFIC SIGNAL LEGEND**

	PROPOSED	EXISTING
DETECTOR LOOP		
SIGNAL HEAD		
G.S. CONDUIT IN TRENCH OR PUSHED		
SIGNAL HEAD WITH BACKPLATE		
RACEWAY FOR MAGNETIC DETECTOR, TYPE I OR II		
VEHICLE DETECTOR, NON-COMPENSATED MAGNETIC TYPE		

**NOTES:**

1. THIS PLAN IS FOR THE SOLE PURPOSE OF DETECTOR LOOP REPLACEMENTS ONLY.
2. REPLACE ALL DETECTOR LOOPS AS SHOWN WITHIN THE RESURFACING LIMITS.
3. ALL DETECTOR LOOPS ARE 6' X 6' UNLESS OTHERWISE SHOWN.
4. AS-BUILT PLAN SHEETS PROVIDED BY IDOT HAVE BEEN INCLUDED FOR BIDDING PURPOSES ONLY, AND DO NOT NECESSARILY REFLECT ACTUAL FIELD CONDITIONS. PROPOSED DETECTOR LOOPS SHALL BE REPLACED AT ALL EXISTING LOCATIONS WITHIN THE PROJECT LIMITS, IN ACCORDANCE WITH STANDARD TS-07, SPECIAL PROVISIONS, AND AS DIRECTED BY THE ENGINEER.

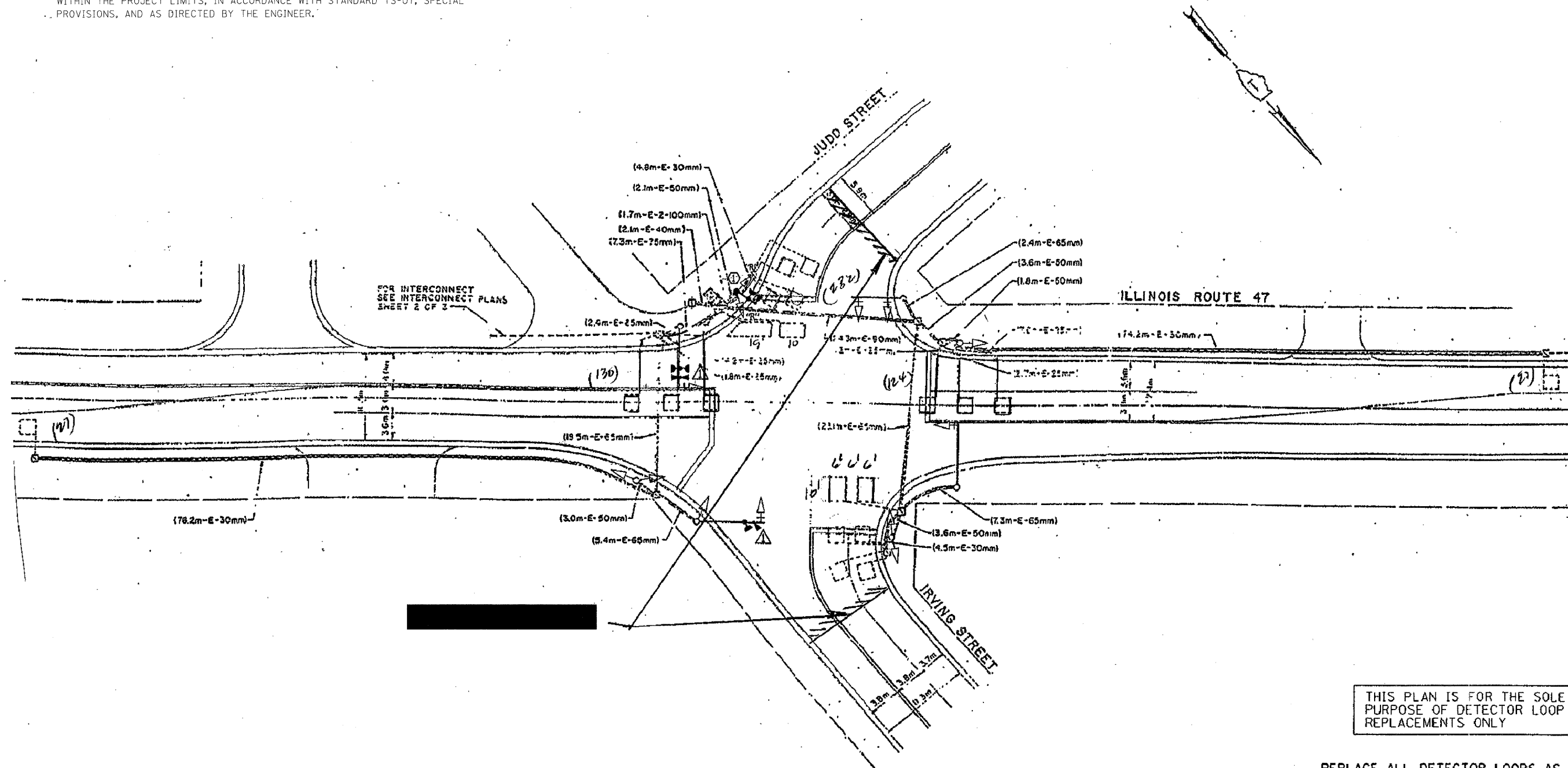

THIS PLAN IS FOR THE SOLE PURPOSE OF DETECTOR LOOP REPLACEMENTS ONLY

REPLACE ALL DETECTOR LOOPS AS SHOWN (WITHIN THE RESURFACING LIMITS)

FILE NAME = #FILE#	USER NAME = #USER#	DESIGNED - DRAWN -	REVISED - REVISED -	<b>STATE OF ILLINOIS DEPARTMENT OF TRANSPORTATION</b>	<b>DETECTOR LOOP PLAN - JUDD STREET &amp; IRVING STREET IL ROUTE 47 FROM IL ROUTE 176 TO IL ROUTE 120</b>			F.A.P. RTE. 326	SECTION 105 RS-9	COUNTY McHENRY	TOTAL SHEETS 37	SHEET NO. 20
	PLOT SCALE = #SCALE#	CHECKED -	REVISED -		SCALE: NONE	SHEET NO. 20 OF 37 SHEETS	STA. 8+85 TO STA. 256+29	D-91-603-09		CONTRACT NO. 60H33		
	PLOT DATE = #DATE#	DATE - 4/2009	REVISED -		FED. ROAD DIST. NO. - ILLINOIS FED. AID PROJECT							

**TRAFFIC SIGNAL LEGEND**

	PROPOSED	EXISTING
DETECTOR LOOP		
SIGNAL HEAD		
G.S. CONDUIT IN TRENCH OR PUSHED		
SIGNAL HEAD WITH BACKPLATE		
RACEWAY FOR MAGNETIC DETECTOR, TYPE I OR II		
VEHICLE DETECTOR, NON-COMPENSATED MAGNETIC TYPE		

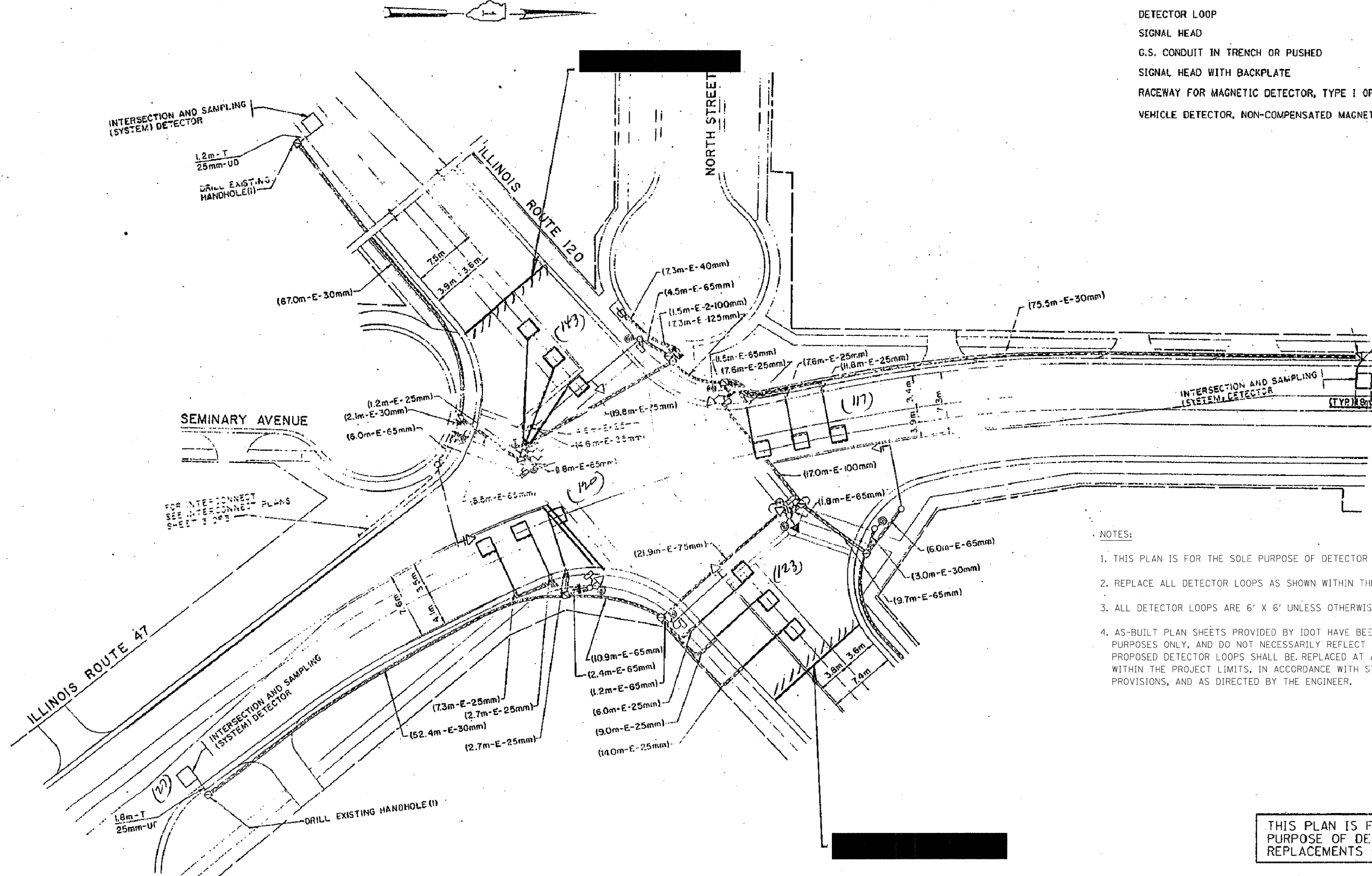

- NOTES:
1. THIS PLAN IS FOR THE SOLE PURPOSE OF DETECTOR LOOP REPLACEMENTS ONLY.
  2. REPLACE ALL DETECTOR LOOPS AS SHOWN WITHIN THE RESURFACING LIMITS.
  3. ALL DETECTOR LOOPS ARE 6' X 6' UNLESS OTHERWISE SHOWN.
  4. AS-BUILT PLAN SHEETS PROVIDED BY IDOT HAVE BEEN INCLUDED FOR BIDDING PURPOSES ONLY, AND DO NOT NECESSARILY REFLECT ACTUAL FIELD CONDITIONS. PROPOSED DETECTOR LOOPS SHALL BE REPLACED AT ALL EXISTING LOCATIONS WITHIN THE PROJECT LIMITS, IN ACCORDANCE WITH STANDARD TS-07, SPECIAL PROVISIONS, AND AS DIRECTED BY THE ENGINEER.

THIS PLAN IS FOR THE SOLE PURPOSE OF DETECTOR LOOP REPLACEMENTS ONLY

REPLACE ALL DETECTOR LOOPS AS SHOWN (WITHIN THE RESURFACING LIMITS)

FILE NAME = #FILE#	USER NAME = #USER#	DESIGNED -	REVISED -	<b>STATE OF ILLINOIS DEPARTMENT OF TRANSPORTATION</b>	<b>DETECTOR LOOP PLAN - IL ROUTE 120 IL ROUTE 47 FROM IL ROUTE 176 TO IL ROUTE 120</b>			F.A.P. RTE. 326	SECTION 105 RS-9	COUNTY McHENRY	TOTAL SHEETS 37	SHEET NO. 21
		DRAWN -	REVISED -		SCALE: NONE	SHEET NO. 21 OF 37 SHEETS	STA. 8+85 TO STA. 256+29	D-91-603-09		CONTRACT NO. 60H33		
		CHECKED -	REVISED -									
		DATE 4/2009	REVISED -		FED. ROAD DIST. NO. [ILLINOIS] FED. AID PROJECT							

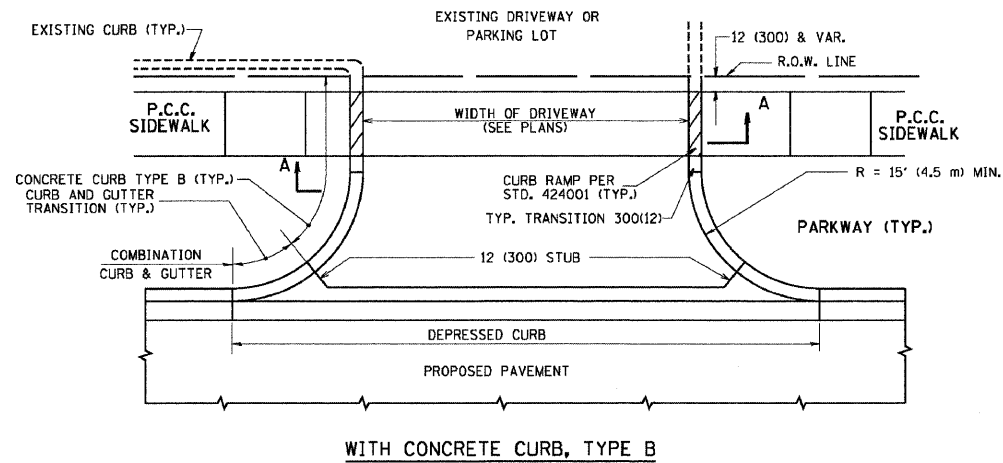

WITH CONCRETE CURB, TYPE B

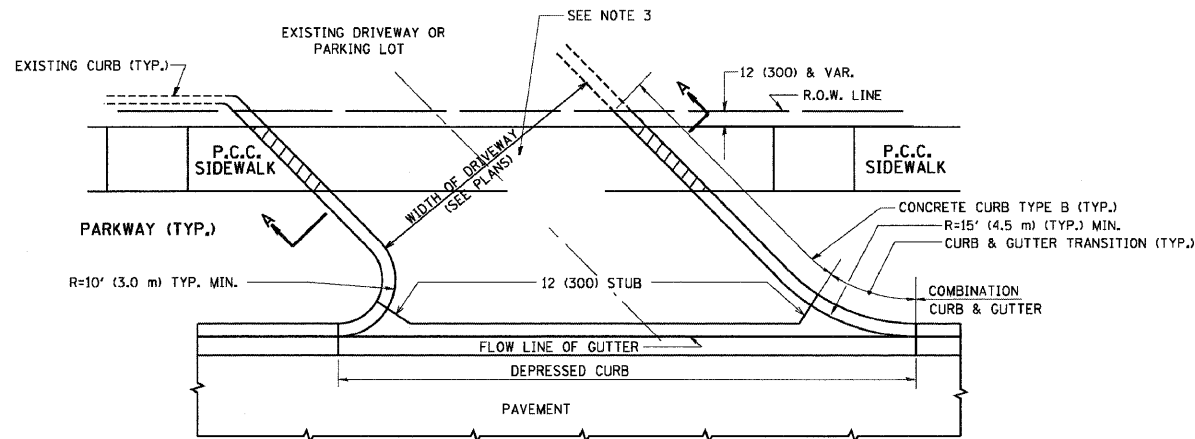

WITH CONCRETE CURB, TYPE B

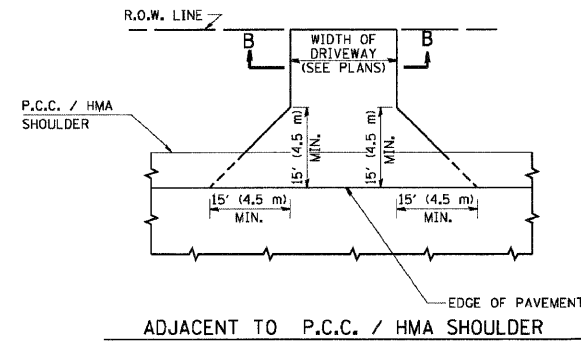
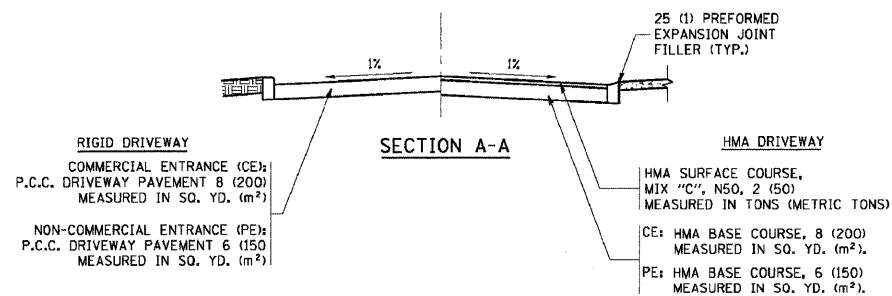

ADJACENT TO P.C.C. / HMA SHOULDER

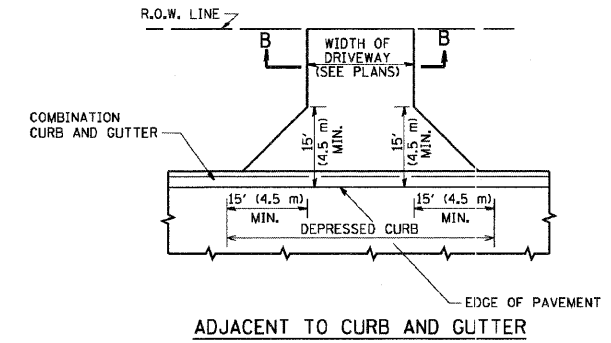

ADJACENT TO CURB AND GUTTER

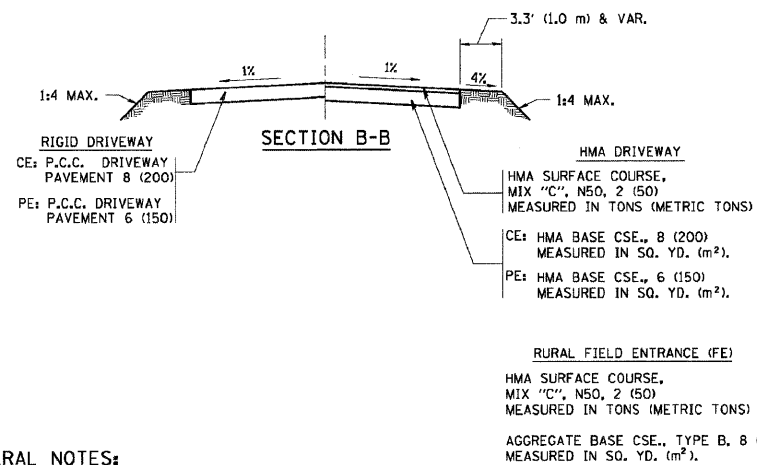

RURAL FIELD ENTRANCE (FE)  
HMA SURFACE COURSE,  
MIX "C", NS0, 2 (50)  
MEASURED IN TONS (METRIC TONS)  
AGGREGATE BASE CSE., TYPE B, 8 (200)  
MEASURED IN SQ. YD. (m²)

**GENERAL NOTES:**

DRIVEWAY SLOPES, LOCATIONS, & GEOMETRIC LAYOUT SHALL BE IN ACCORDANCE WITH THE LATEST EDITION OF THE "HANDBOOK FOR POLICY ON PERMITS FOR ACCESS DRIVEWAYS TO STATE HIGHWAYS". FOR FURTHER LAYOUT REQUIREMENTS, REFER TO ILLUSTRATIONS IN THE PERMIT HANDBOOK. DRIVEWAYS SHALL BE REPLACED IN KIND, UNLESS OTHERWISE NOTED ON THE PLANS.

COMMERCIAL DRIVEWAYS SHALL BE CONSTRUCTED WITH CONCRETE CURB, TYPE B RETURNS EXCEPT WHEN THE SIDEWALK EDGE IS 4 FEET (1.2 METERS) OR LESS FROM THE BACK OF CURB, CONSTRUCT A FLARE DRIVEWAY WITHOUT CURB.

THE RESIDENT ENGINEER SHALL CONTACT THE TRAFFIC PERMIT OFFICE AT 847/ 705-4131 FOR ANY QUESTIONS ON DRIVEWAYS SHOWN IN THE PLANS; SPECIFICALLY IN REFERENCE TO ADDITIONAL AND/OR RELOCATION/REMOVAL OF A DRIVEWAY.

COMBINATION CONCRETE CURB & GUTTER SHALL BE MEASURED STRAIGHT ACROSS THE DRIVEWAY. NO ADDITIONAL COMPENSATION WILL BE ALLOWED FOR THE CURB & GUTTER TRANSITION.

1 (25) PREFORMED EXPANSION JOINT FILLER WILL NOT BE PAID SEPARATELY, BUT SHALL BE CONSIDERED INCLUDED IN THE COST OF THE P.C.C. DRIVEWAY PAVEMENT OR P.C.C. SIDEWALK.

WHEN THE P.C.C. SIDEWALK EXTENDS THROUGH THE DRIVEWAY, THE THICKNESS OF THE SIDEWALK IN THE DRIVEWAY AREA SHALL BE THE SAME AS THE DRIVEWAY THICKNESS. SIDEWALK WILL BE PAID FOR AS P.C.C. SIDEWALK OF THE THICKNESS SPECIFIED. SIDEWALK CROSS SLOPE THRU DRIVEWAY AREA TO BE A MAXIMUM OF 1:50.

**DRIVEWAY DETAILS – DISTANCE BETWEEN R.O.W. AND CURB OR EDGE GREATER THAN OR EQUAL TO 15'**

FILE NAME =	USER NAME = #USER#	DESIGNED - ---	REVISED - -----	<b>STATE OF ILLINOIS DEPARTMENT OF TRANSPORTATION</b>	<b>DISTRICT ONE DETAIL SHEETS</b>			F.A.P. RTE.	SECTION	COUNTY	TOTAL SHEETS	SHEET NO.
#FILE#		DRAWN - ---	REVISED - -----		<b>IL ROUTE 47 FROM IL ROUTE 176 TO IL ROUTE 120</b>			326	105 RS-9	McHENRY	37	22
		CHECKED - ---	REVISED - -----		SCALE: NONE SHEET NO. 22 OF 37 SHEETS STA. 8+85 TO STA. 256+29			D-91-603-09		CONTRACT NO. 60H33		
		DATE - 4/2009	REVISED - -----					FED. ROAD DIST. NO. ILLINOIS FED. AID PROJECT				

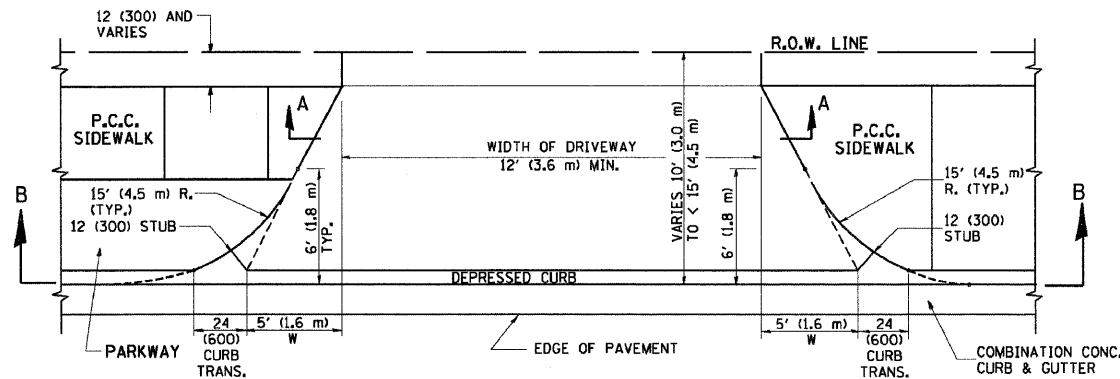

PLAN  
10' (3.0 m) TO < 15' (4.5 m)

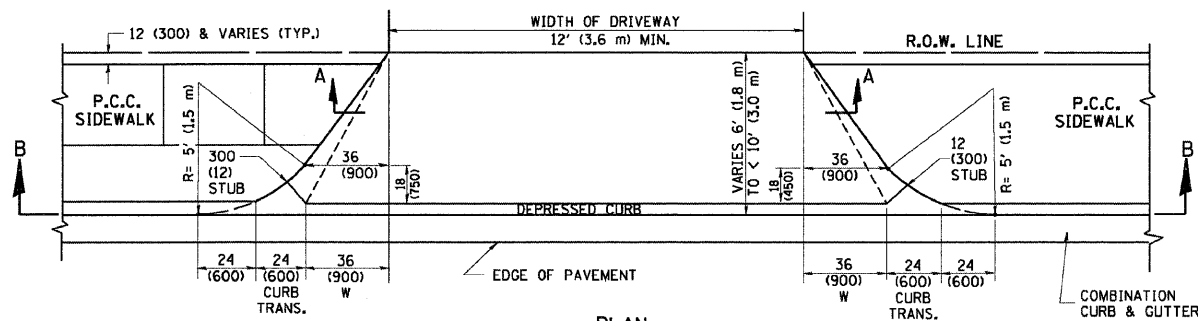

PLAN  
6' (1.8 m) TO < 10' (3.0 m)

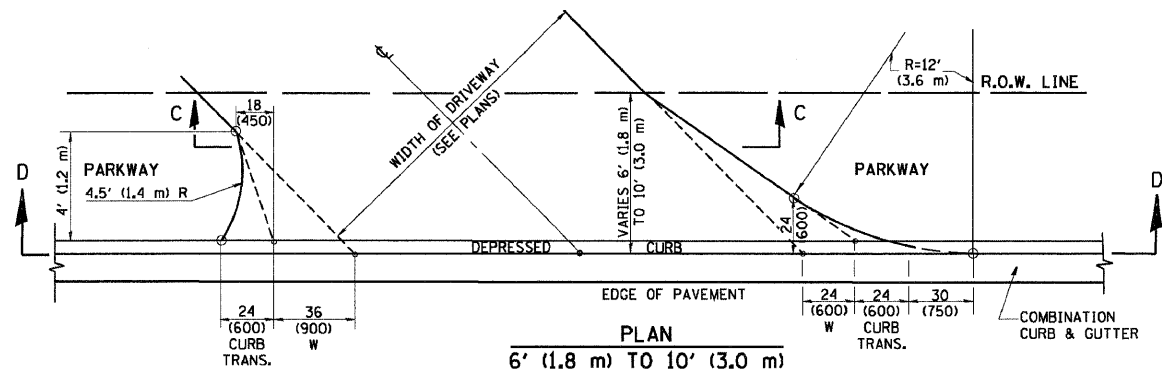

PLAN  
6' (1.8 m) TO 10' (3.0 m)

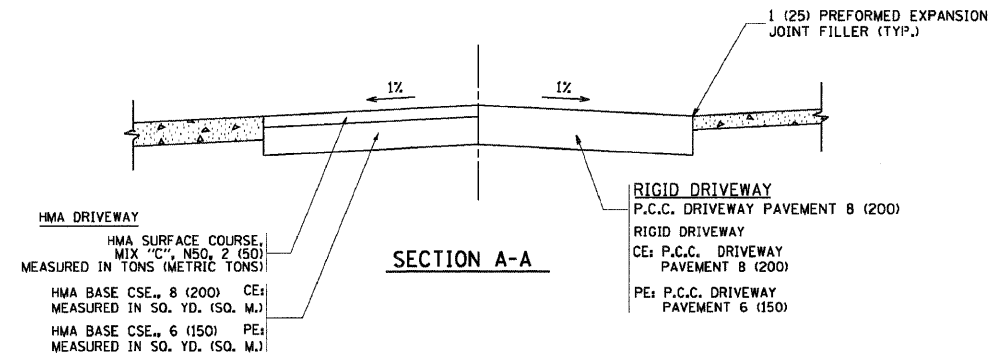

SECTION A-A

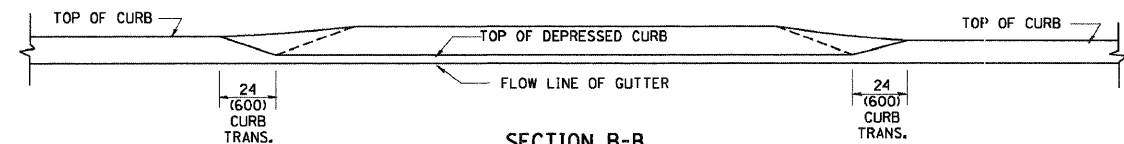

SECTION B-B

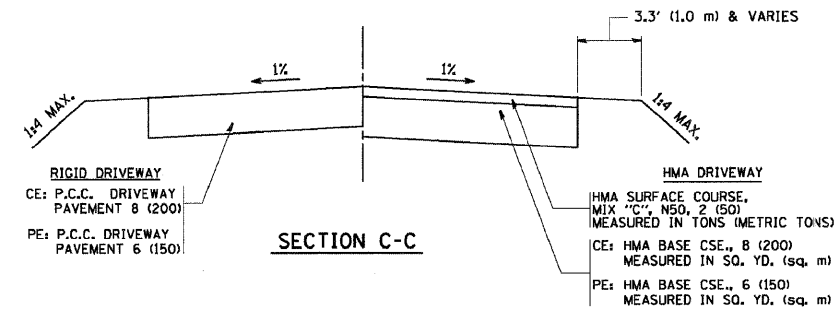

SECTION C-C

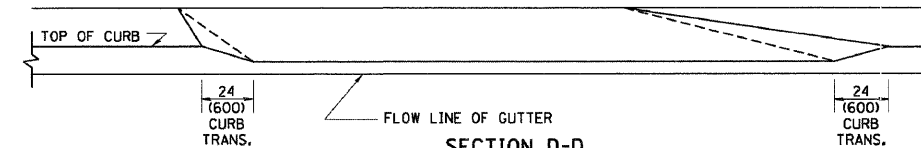

SECTION D-D

GENERAL NOTES

DRIVEWAY SLOPES, LOCATIONS, & GEOMETRIC LAYOUT SHALL BE IN ACCORDANCE WITH THE LATEST EDITION OF THE "HANDBOOK FOR POLICY ON PERMITS FOR ACCESS DRIVEWAYS TO STATE HIGHWAYS". FOR FURTHER LAYOUT REQUIREMENTS, REFER TO ILLUSTRATION 10 IN THE PERMIT HANDBOOK. WHERE SIDEWALKS EXIST, DRIVEWAYS SHALL BE REPLACED WITH RIGID PAVEMENT. WHERE NO SIDEWALKS EXIST, DRIVEWAYS SHALL BE REPLACED IN KIND. SIDEWALK CROSS SLOPE THRU DRIVEWAY AREA TO BE A MAXIMUM OF 1:50.

WHEN THE DISTANCE BETWEEN R.O.W. AND THE BACK OF CURB IS EQUAL TO OR LESS THAN 8' (2.4 m), THE P.C.C. SIDEWALK SHALL EXTEND TO THE BACK OF CURB.

THE RESIDENT ENGINEER SHALL CONTACT THE TRAFFIC PERMIT OFFICE AT 847/705-4131 FOR ANY QUESTIONS ON DRIVEWAYS SHOWN IN THE PLANS; SPECIFICALLY IN REFERENCE TO ADDITIONAL AND/OR RELOCATION/REMOVAL OF A DRIVEWAY.

COMBINATION CONCRETE CURB & CUTTER SHALL BE MEASURED STRAIGHT ACROSS THE DRIVEWAY. NO ADDITIONAL COMPENSATION WILL BE ALLOWED FOR THE CURB & CUTTER TRANSITION.

THE 1 (25) PREFORMED EXPANSION JOINT FILLER WILL NOT BE PAID SEPARATELY, BUT SHALL BE CONSIDERED INCLUDED IN THE COST OF THE P.C.C. DRIVEWAY PAVEMENT OR P.C.C. SIDEWALK.

"W" VARIES FROM 36 (900) TO 5' (1.5 m) PROPORTIONAL TO THE LENGTH (L), FROM 6' (1.8 m) TO 10' (3 m).

ALL DIMENSIONS ARE IN INCHES (MILLIMETERS) UNLESS OTHERWISE NOTED.

**DRIVEWAY DETAILS – DISTANCE BETWEEN R.O.W. AND FACE OF CURB IS LESS THAN 15'**

FILE NAME =	USER NAME = #USER*	DESIGNED -	REVISED -	<b>STATE OF ILLINOIS DEPARTMENT OF TRANSPORTATION</b>	<b>DISTRICT ONE DETAIL SHEETS</b>			F.A.P. RTE.	SECTION	COUNTY	TOTAL SHEETS	SHEET NO.
#FILE#		DRAWN -	REVISED -		<b>IL ROUTE 47 FROM IL ROUTE 176 TO IL ROUTE 120</b>			326	105 RS-9	McHENRY	37	23
		CHECKED -	REVISED -		SCALE: NONE SHEET NO. 23 OF 37 SHEETS STA. 8+85 TO STA. 256+29			<b>D-91-603-09</b>		<b>CONTRACT NO. 60H33</b>		
		DATE - 4/2009	REVISED -					FED. ROAD DIST. NO. - [ILLINOIS] FED. AID PROJECT				

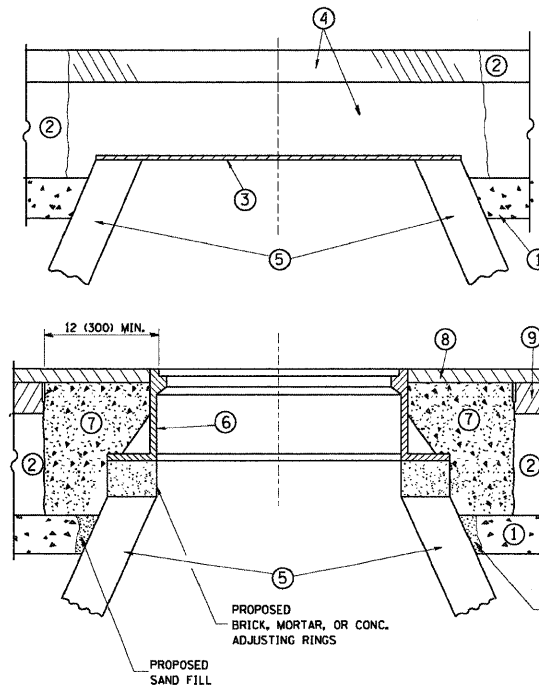

**CONSTRUCTION PROCEDURES**

**STAGE 1 (BEFORE PAVEMENT MILLING)**

- A) REMOVE A MINIMUM OF 12 (300) OF THE PAVEMENT FROM AROUND THE STRUCTURE.
- B) REMOVE THE EXISTING FRAME AND LID FROM THE STRUCTURE.
- C) COVER THE STRUCTURE OPENING WITH A 36 (900) DIAMETER METAL PLATE.
- D) BACKFILL WITH CRUSHED STONE AND A MINIMUM 1 1/2 (40) THICK HMA SURFACE MIX APPROVED BY THE ENGINEER.

**STAGE 2 (AFTER PAVEMENT MILLING)**

- A) REMOVE THE HMA SURFACE MIX AND CRUSHED STONE.
- B) INSTALL THE FRAME AND LID; ADJUST THE FRAME TO ITS FINAL SURFACE ELEVATION.
- C) THE SURROUNDING SPACE SHALL BE FILLED WITH CLASS S1 CONCRETE, OR HMA SURFACE COURSE OR HMA BINDER COURSE TO THE ELEVATION OF THE SURFACE OF THE EXISTING BASE COURSE OR THE BINDER COURSE.

THE PROCEDURE EXPLAINED ABOVE SHALL CONFORM TO THE APPLICABLE PORTIONS OF SECTIONS 353, 406, 602, AND 603 OF THE STANDARD SPECIFICATIONS.

**NOTES:**

EXISTING BROKEN FRAMES AND LIDS SHALL BE REMOVED AND DISPOSED OF BY THE CONTRACTOR AND SHALL BE REPLACED AS DIRECTED BY THE ENGINEER. REPLACEMENT FRAMES AND LIDS WILL BE PAID FOR IN ACCORDANCE WITH ARTICLE 109.04 OF THE STANDARD SPECIFICATIONS UNLESS A SEPARATE PAY ITEM HAS BEEN PROVIDED.

IF THE EXISTING LIDS ARE OPEN, THE FRAME WILL BE ADJUSTED TO THE ELEVATION OF THE MILLED PAVEMENT SURFACE PRIOR TO THE MILLING OPERATION. THE FRAME WILL NOT BE REMOVED AND COVERED BY THE METAL PLATE.

CITY OF CHICAGO CASTINGS ARE THE PROPERTY OF THE CITY AND THE CONTRACTOR SHALL NOTIFY THE CITY FOR REMOVAL AND DISPOSITION OF THE CASTINGS.

THE METAL PLATE USED TO COVER THE STRUCTURE SHALL REMAIN THE PROPERTY OF THE CONTRACTOR.

WHEN STRUCTURES ARE TO BE ADJUSTED OR RECONSTRUCTED, THE LOWERING AND RAISING OF THE FRAMES AND LIDS WILL NOT BE PAID FOR SEPARATELY BUT WILL BE INCLUDED IN THE COST OF THE CORRESPONDING PAY ITEM.

**LEGEND**

- ① SUB-BASE GRANULAR MATERIAL
- ② EXISTING PAVEMENT
- ③ 36 (900) DIAMETER METAL PLATE
- ④ PROPOSED CRUSHED STONE AND HMA SURFACE MIX
- ⑤ EXISTING STRUCTURE
- ⑥ FRAME AND LID (SEE NOTES)
- ⑦ CLASS S1 CONCRETE, HMA SURFACE COURSE OR HMA BINDER COURSE
- ⑧ PROPOSED HMA SURFACE COURSE
- ⑨ PROPOSED HMA BINDER COURSE

**LOCATION OF STRUCTURES:**

THE CONTRACTOR WILL BE REQUIRED TO KEEP A RECORD OF THE LOCATIONS OF THE BURIED STRUCTURES ACCORDING TO THE STATION AND DISTANCE LEFT OR RIGHT OF THE CENTERLINE OF PAVEMENT. UPON COMPLETION OF THE WORK, THE CONTRACTOR WILL DELIVER THE RECORD TO THE ENGINEER.

**BASIS OF PAYMENT:** THIS WORK WILL BE PAID FOR AT THE CONTRACT UNIT PRICE PER EACH FOR "FRAMES AND LIDS TO BE ADJUSTED, SPECIAL" NEW FRAMES AND LIDS, WHEN SPECIFIED, WILL BE PAID FOR SEPARATELY.

**DETAILS FOR FRAMES AND LIDS ADJUSTMENT WITH MILLING**

ALL DIMENSIONS ARE IN INCHES (MILLIMETERS) UNLESS OTHERWISE SHOWN

**FRAMES AND LIDS ADJUSTMENT WITH MILLING; AND FRAMES AND LIDS ADJUSTMENT WITHOUT MILLING**

FILE NAME = \$FILEL\$	USER NAME = \$USER\$	DESIGNED - ---	REVISED - ---	<b>STATE OF ILLINOIS DEPARTMENT OF TRANSPORTATION</b>	<b>DISTRICT ONE DETAIL SHEETS IL ROUTE 47 FROM IL ROUTE 176 TO IL ROUTE 120</b>			F.A.P. RTE. 326	SECTION 105 RS-9	COUNTY McHENRY	TOTAL SHEETS 37	SHEET NO. 24
		DRAWN - ---	REVISED - ---		SCALE: NONE			SHEET NO. 24 OF 37 SHEETS			CONTRACT NO. 60H33	
		CHECKED - ---	REVISED - ---		STA. 8+85 TO STA. 256+29			FED. ROAD DIST. NO. ILLINOIS FED. AID PROJECT				
		DATE - 4/2009	REVISED - ---									



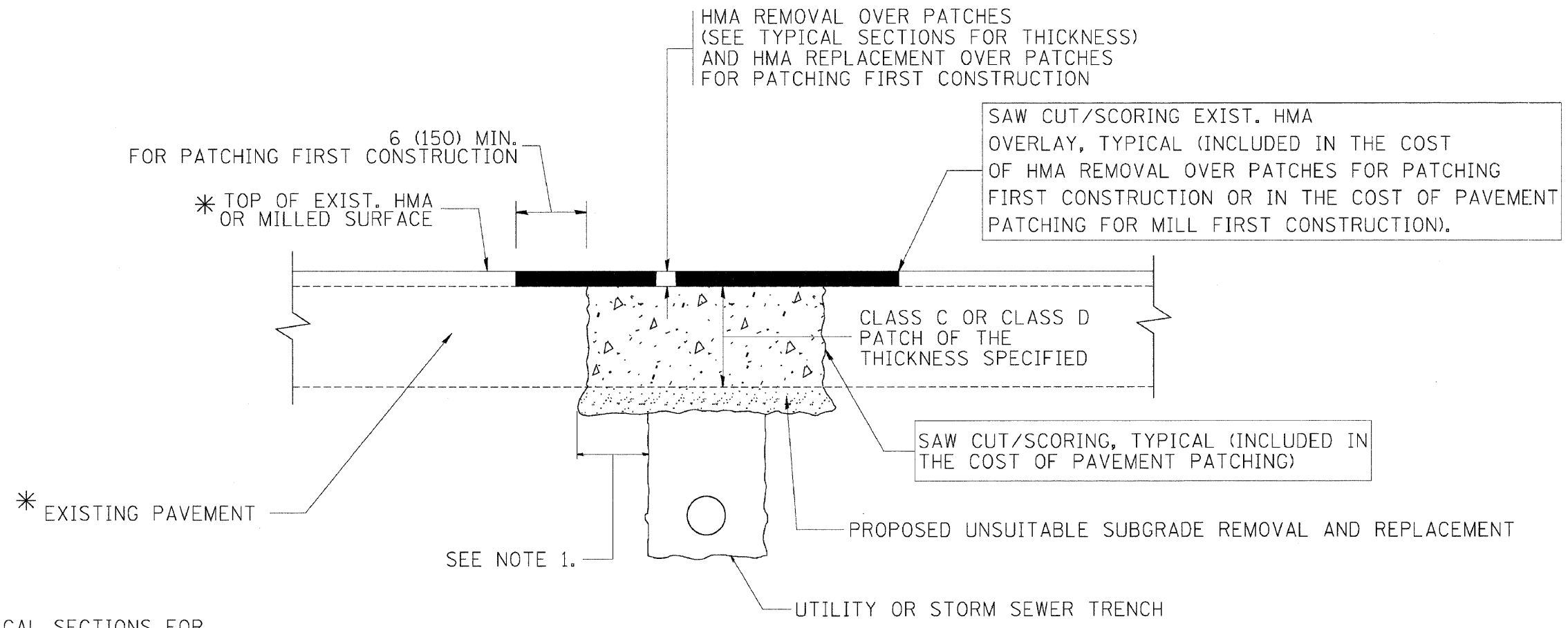

\* SEE TYPICAL SECTIONS FOR THICKNESS AND MATERIALS

**NOTES:**

1. THE WIDTH OF THE FULL DEPTH PATCH OVER A TRENCH SHALL BE 12 (300) WIDER ON EACH SIDE OF THE TRENCH.
2. FOR METHOD OF MEASUREMENT AND BASIS OF PAYMENT, SEE RECURRING SPECIAL PROVISION "PATCHING WITH HOT-MIX ASPHALT OVERLAY REMOVAL".

**SEQUENCE OF CONSTRUCTION (PATCHING FIRST)**

1. REMOVE THE EXISTING HMA MATERIAL OVER THE AREA TO BE PATCHED.
2. REMOVE AND REPLACE WITH CLASS C OR D PATCH.
3. REPLACE HMA MATERIAL OVER THE AREA TO BE PATCHED.

**SEQUENCE OF CONSTRUCTION (MILLING FIRST)**

1. MILL HMA FIRST IF THERE IS AT LEAST 4 1/2 INCHES OR MORE OF HMA MATERIAL ON TOP OF THE EXISTING PAVEMENT OR IF THE PAVEMENT IS FULL DEPTH HMA. A MINIMUM OF 2 INCHES OF HMA MATERIAL SHALL BE IN PLACE AFTER MILLING.
2. REMOVE AND REPLACE WITH FULL DEPTH CLASS D PATCHES TO TOP OF MILLED SURFACE.

ALL DIMENSIONS ARE IN INCHES (MILLIMETERS) UNLESS OTHERWISE SHOWN.

**PAVEMENT PATCHING FOR HMA SURFACED PAVEMENT**

FILE NAME =	USER NAME = \$USER\$	DESIGNED -	REVISED -	<b>STATE OF ILLINOIS DEPARTMENT OF TRANSPORTATION</b>	<b>DISTRICT ONE DETAIL SHEETS</b>			F.A.P. RTE:	SECTION	COUNTY	TOTAL SHEETS	SHEET NO.
\$FILEL\$		DRAWN -	REVISED -		<b>IL ROUTE 47 FROM IL ROUTE 176 TO IL ROUTE 120</b>			326	105 RS-9	McHENRY	37	25
		CHECKED -	REVISED -		SCALE: NONE   SHEET NO. 25 OF 37 SHEETS   STA. 8+85 TO STA. 256+29			<b>D-91-603-09</b>		<b>CONTRACT NO. 60H33</b>		
		DATE - 4/2009	REVISED -		FED. ROAD DIST. NO. - [ILLINOIS] FED. AID PROJECT							

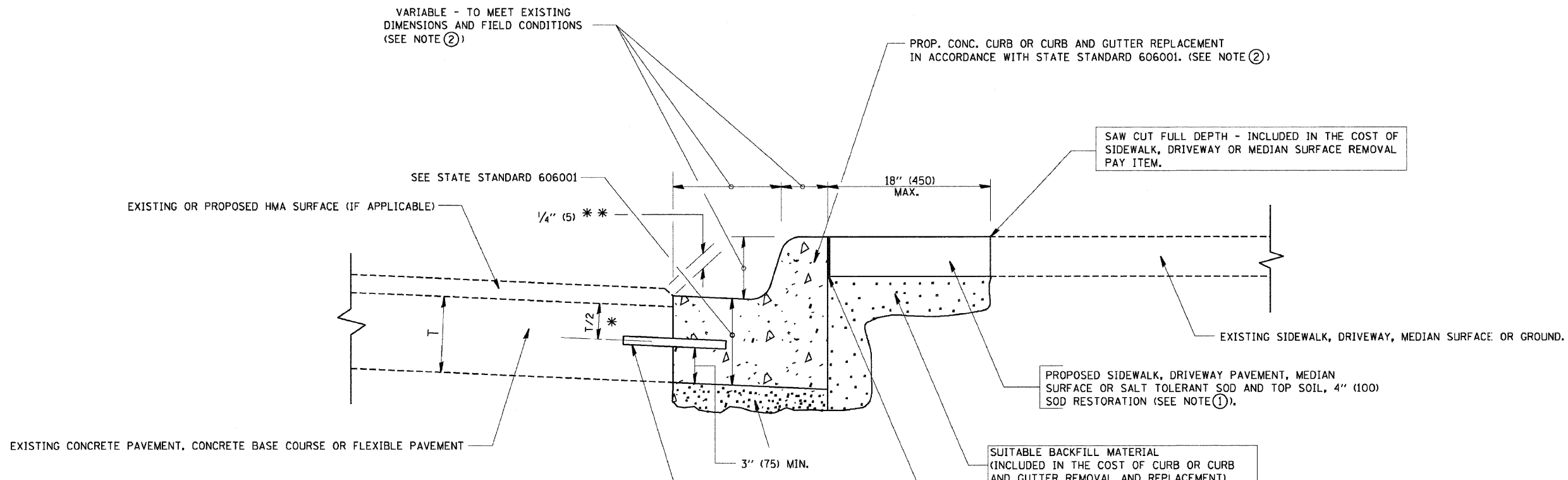

- \* 3" (75) MINIMUM FROM TOP AND BOTTOM OF THE CONCRETE PAVEMENT OR BASE COURSE.
- \*\* IF THE FINAL SURFACE OF THE PAVEMENT IS CONCRETE, THE GUTTER IS TO BE FLUSH WITH THE PAVEMENT.

NOTE: ① SIDEWALK, DRIVEWAY PAVEMENT OR MEDIAN SURFACE SHALL BE SIMILAR TO THE MATERIAL BEING REMOVED AND WILL BE PAID FOR SEPARATELY.

SALT TOLERANT SOD AND TOP SOIL, 4" (100) RESTORATION WILL NOT BE PAID FOR SEPARATELY, BUT SHALL BE INCLUDED IN THE COST OF CURB OR CURB AND GUTTER REMOVAL AND REPLACEMENT.

- ② CURB OR CURB AND GUTTER REPLACEMENT SHALL MATCH THE SHAPE OF THE EXISTING CURB OR CURB AND GUTTER UNLESS OTHERWISE SPECIFIED.
- ③ FOR CURB OR CURB AND GUTTER REMOVAL AND REPLACEMENT ADJACENT TO FLEXIBLE PAVEMENT DELETE EPOXY COATED TIE BARS.
- ④ LONGITUDINAL BARS, IF ENCOUNTERED IN THE EXISTING CURB OR CURB AND GUTTER, ARE NOT TO BE REPLACED. CUTTING AND REMOVING LONGITUDINAL BARS SHALL BE INCLUDED IN THE COST OF CURB OR CURB AND GUTTER REMOVAL AND REPLACEMENT.
- ⑤ THE COST OF HMA SURFACE REMOVAL IN THE EXISTING GUTTER FLAG SHALL BE INCLUDED IN THE COST OF THE CURB AND GUTTER REMOVAL AND REPLACEMENT.
- ⑥ THE REMOVAL AND REPLACEMENT OF THE EXISTING CURB OR CURB AND GUTTER SHALL BE DONE IN ACCORDANCE WITH THE APPLICABLE PORTIONS OF SECTION 440 AND 606 OF THE STANDARD SPECIFICATIONS.
- ⑦ THE LOCATIONS OF REMOVAL AND REPLACEMENT OF EXISTING CURB OR CURB AND GUTTER SHALL BE DETERMINED BY THE RESIDENT ENGINEER AT THE TIME OF CONSTRUCTION.

UNSUITABLE SUB-BASE MATERIAL TO BE REMOVED, IF DIRECTED BY THE ENGINEER, SHALL BE REPLACED WITH EITHER SUB-BASE GRANULAR MATERIAL, TYPE B OR ADDITIONAL THICKNESS OF CONCRETE.

REMOVAL AND REPLACEMENT 4" (100) OR LESS IS INCLUDED IN THE COST OF CURB OR CURB AND GUTTER REMOVAL AND REPLACEMENT.

REMOVAL AND REPLACEMENT IN EXCESS OF 4" (100) WILL BE PAID FOR IN ACCORDANCE WITH ARTICLE 109.04 OF THE STANDARD SPECIFICATIONS.

PROPOSED #6 (20) EPOXY COATED TIE BARS 24" (600) LONG AT 24" (600) CENTERS WILL NOT BE PAID FOR SEPARATELY. DELETE EPOXY COATED TIE BARS IF EXISTING TIE BARS ARE USABLE AS DETERMINED BY THE ENGINEER. (SEE NOTE ③).

**BASIS OF PAYMENT:**  
THIS WORK WILL BE PAID FOR AT THE CONTRACT UNIT PRICE PER FOOT (METER) FOR "CURB REMOVAL AND REPLACEMENT" OR "COMBINATION CONCRETE CURB AND GUTTER REMOVAL AND REPLACEMENT".

## CURB OR CURB AND GUTTER REMOVAL AND REPLACEMENT

ALL DIMENSIONS ARE IN INCHES (MILLIMETERS) UNLESS OTHERWISE SHOWN.

### CURB OR CURB AND GUTTER REMOVAL AND REPLACEMENT

FILE NAME = #FILE#	USER NAME = #USER#	DESIGNED - ---	REVISED - ---	<b>STATE OF ILLINOIS DEPARTMENT OF TRANSPORTATION</b>	<b>DISTRICT ONE DETAIL SHEETS IL ROUTE 47 FROM IL ROUTE 176 TO IL ROUTE 120</b>	F.A.P. RTE. 326	SECTION 105 RS-9	COUNTY McHENRY	TOTAL SHEETS 37	SHEET NO. 26	
		DRAWN - ---	REVISED - ---			D-91-603-09			CONTRACT NO. 60H33		
		CHECKED - ---	REVISED - ---		SCALE: NONE	SHEET NO. 26 OF 37 SHEETS	STA. 8+85 TO STA. 256+29	FED. ROAD DIST. NO. - [ILLINOIS] FED. AID PROJECT			
		DATE - 4/2009	REVISED - ---								

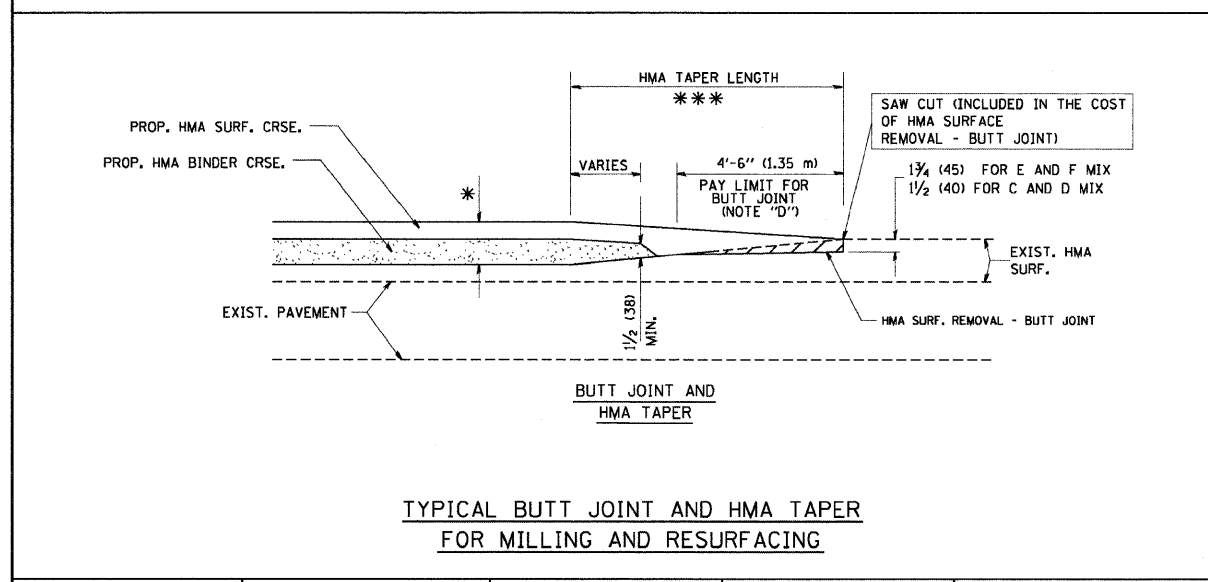
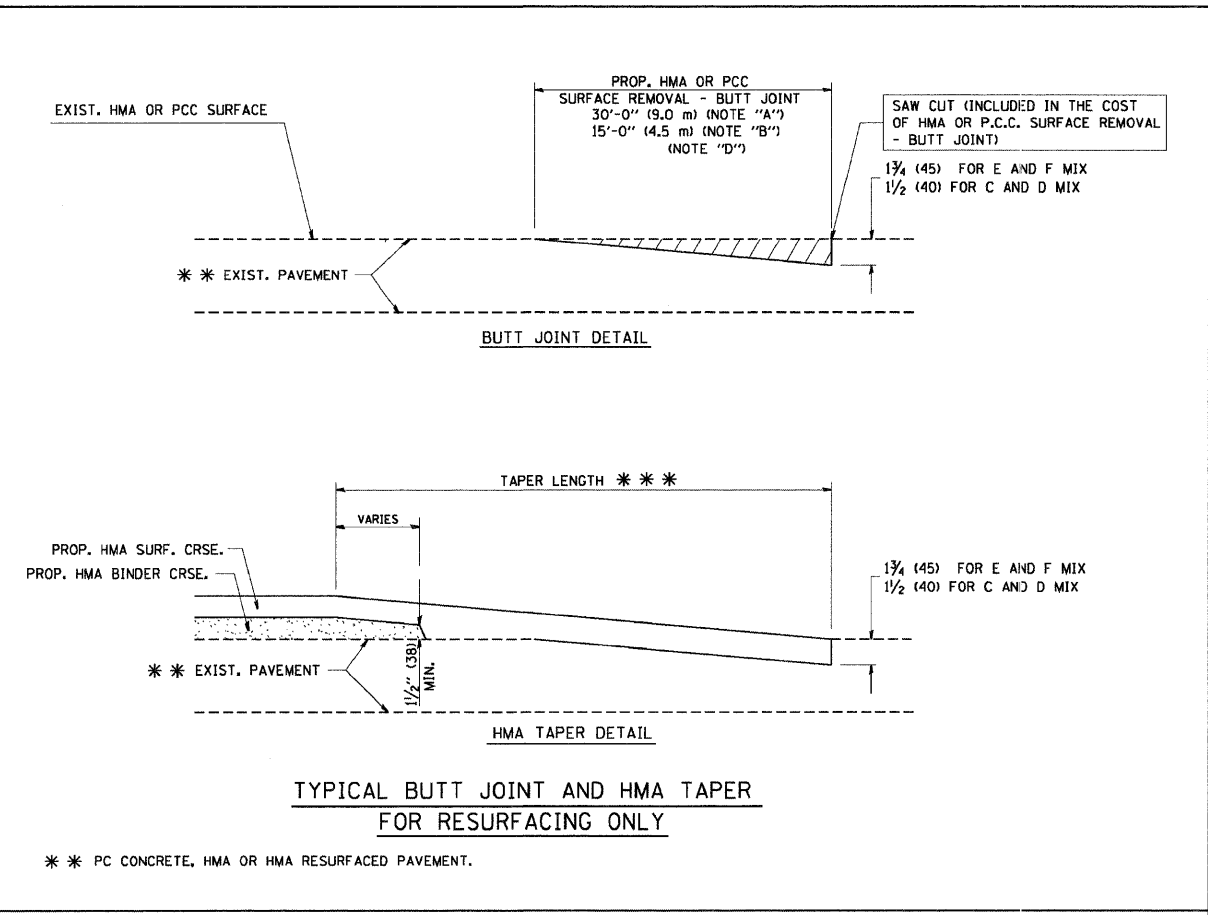
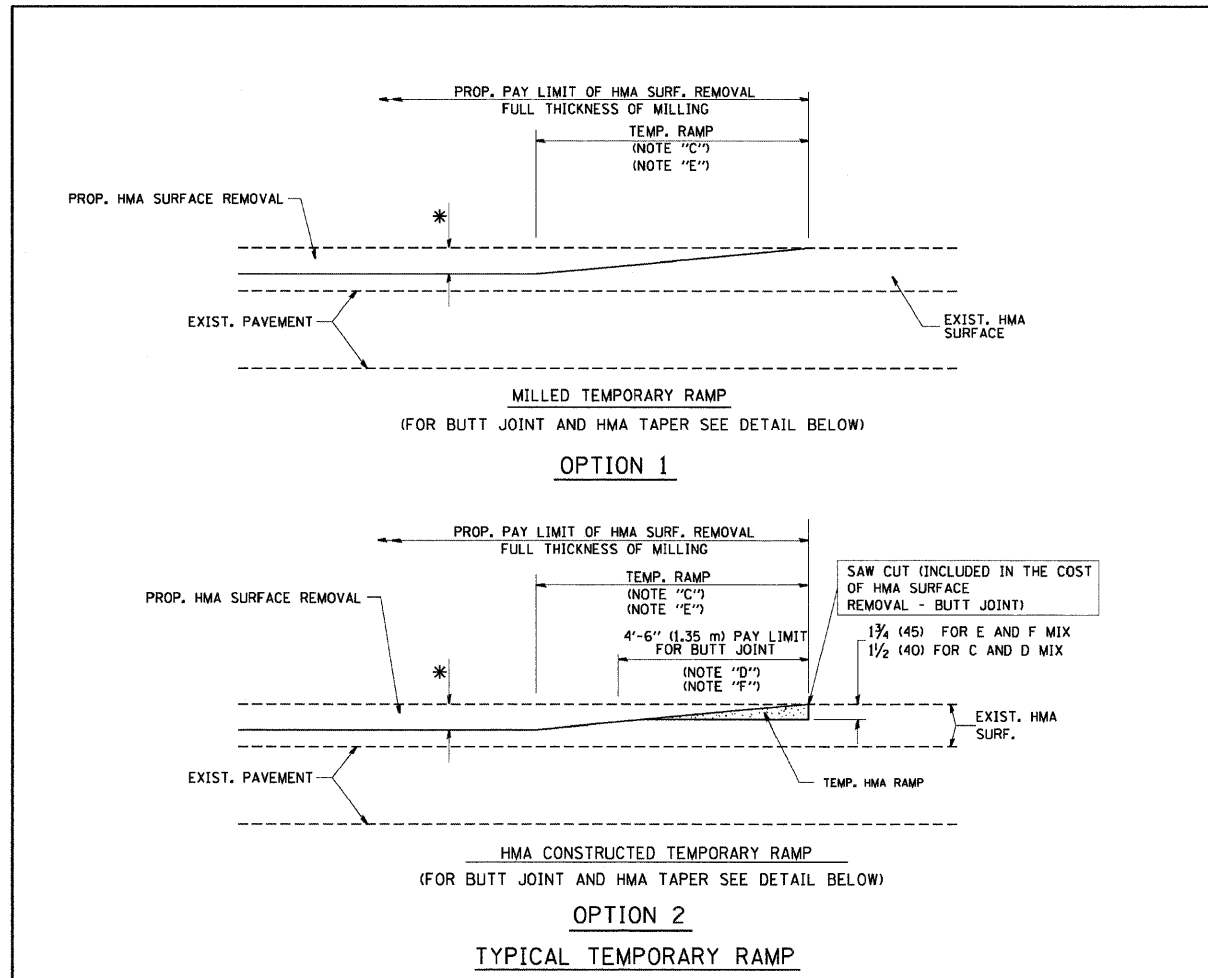

**NOTES**

A: MAINLINE ROADWAYS AND MAJOR SIDE ROADS.  
 B: MINOR SIDE ROADS.  
 C: THE TEMP. RAMP SHALL BE CONSTRUCTED IMMEDIATELY UPON REMOVAL OF THE EXISTING HMA SURFACE.  
 D: THE BUTT JOINT SHALL BE CONSTRUCTED IMMEDIATELY PRIOR TO PLACING THE PROPOSED HMA COURSES.  
 E: TAPER THE TEMP. RAMP AT A RATE OF 3'-0" (900 mm) PER 1 INCH (25 mm) OF MILLING THICKNESS.  
 F: INSTALLATION AND REMOVAL OF THE 4'-6" (1.35 m) TEMP. RAMP IS INCLUDED IN COST OF HMA SURFACE REMOVAL - BUTT JOINT  
 G: SEE ARTICLE 406.08 AND 406.14 OF THE STANDARD SPECIFICATIONS FOR "HMA AND/OR PCC SURFACE REMOVAL, BUTT JOINT".

\* SEE TYPICAL SECTIONS FOR MILLING THICKNESS.

\*\*\* 20'-0" (6.1 m) PER 1 (25) RESURFACING (NOTE "A")  
 10'-0" (3.0 m) PER 1 (25) RESURFACING (NOTE "B")

**BASIS OF PAYMENT:**  
 THE BUTT JOINT WILL BE PAID FOR AT THE CONTRACT UNIT PRICE PER SQUARE YARD (SQUARE METER) FOR "HOT-MIX ASPHALT SURFACE REMOVAL - BUTT JOINT" OR FOR "PORTLAND CEMENT CONCRETE SURFACE REMOVAL - BUTT JOINT".

ALL DIMENSIONS ARE IN INCHES (MILLIMETERS) UNLESS OTHERWISE SHOWN.

**BUTT JOINTS AND HMA TAPER**

FILE NAME =	USER NAME = #USER#	DESIGNED -	REVISED -	<b>STATE OF ILLINOIS DEPARTMENT OF TRANSPORTATION</b>	<b>DISTRICT ONE DETAIL SHEETS IL ROUTE 47 FROM IL ROUTE 176 TO IL ROUTE 120</b>			F.A.P. RTE.:	SECTION	COUNTY	TOTAL SHEETS	SHEET NO.
#FILE#		DRAWN -	REVISED -		326	105 RS-9	McHENRY	37	27			
PLOT SCALE = #SCALE#		CHECKED -	REVISED -		D-91-603-09			CONTRACT NO. 60H33				
PLOT DATE = #DATE#	DATE - 4/2009	REVISED -	REVISED -		SCALE: NONE	SHEET NO. 27 OF 37 SHEETS	STA. 8+85 TO STA. 256+29	FED. ROAD DIST. NO. [ILLINOIS] FED. AID PROJECT				

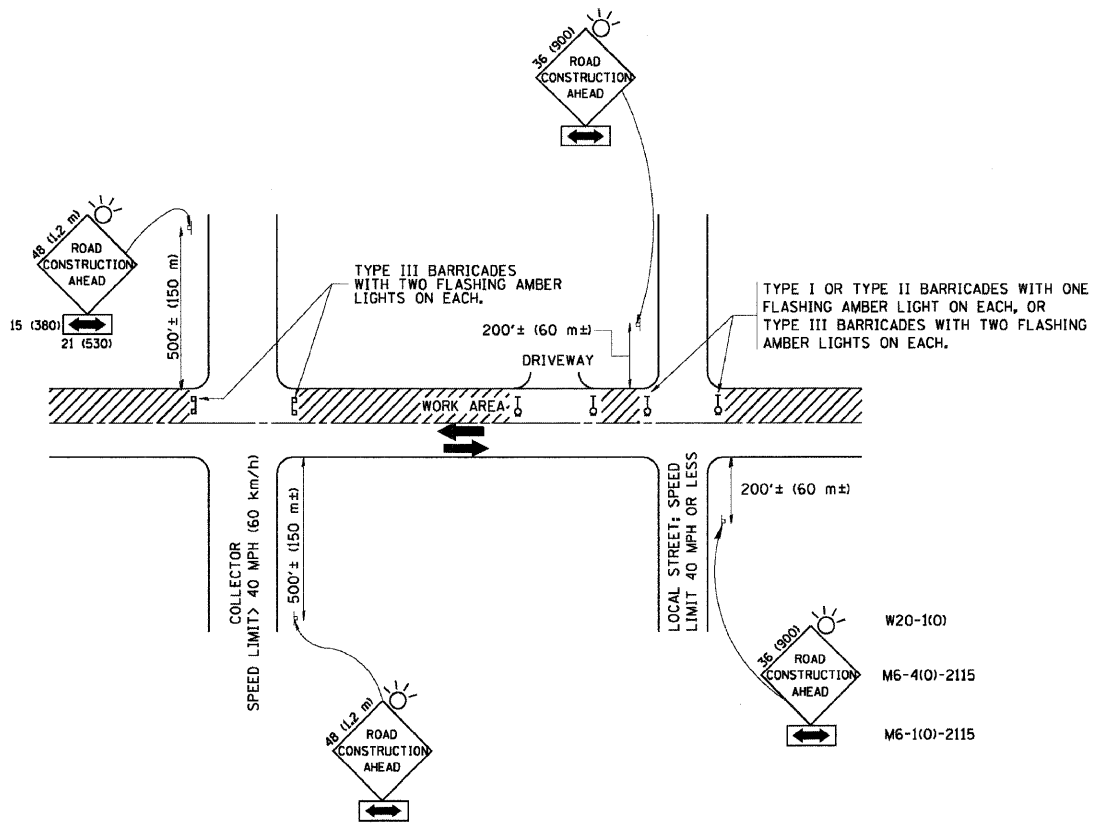

TRAFFIC CONTROL AND PROTECTION FOR SIDE ROADS, INTERSECTIONS, AND DRIVEWAYS

NOTES:

A. FOR NO LANE RESTRICTION ON THE SIDE ROAD OR DRIVEWAYS

1. SIDE ROAD WITH A SPEED LIMIT OF 40 MPH (60 km/h) OR LESS AS SHOWN ON THE DRAWING AND AS DIRECTED BY THE ENGINEER:
  - a) ONE ROAD CONSTRUCTION AHEAD SIGN 36 x 36 (900x900) WITH A FLASHER AND FLAG MOUNTED ON IT APPROXIMATELY 200' (60 m) IN ADVANCE OF THE MAIN ROUTE.
  - b) THE CLOSED PORTION OF THE MAIN ROUTE SHALL BE PROTECTED BY BLOCKING WITH TYPE I, TYPE II OR TYPE III BARRICADES, 1/3 OF THE CROSS SECTION OF THE CLOSED PORTION.
2. SIDE ROAD WITH A SPEED LIMIT GREATER THAN 40 MPH (60 km/h) AS SHOWN ON THE DRAWING AND AS DIRECTED BY THE ENGINEER:
  - a) ONE ROAD CONSTRUCTION AHEAD SIGN 48 x 48 (1.2 m x 1.2 m) WITH A FLASHER MOUNTED ON IT APPROXIMATELY 500' (150 m) IN ADVANCE OF THE MAIN ROUTE.
  - b) THE CLOSED PORTION OF THE MAIN ROUTE SHALL BE PROTECTED BY BLOCKING WITH TYPE III BARRICADES, 1/2 OF THE CROSS SECTION OF THE CLOSED PORTION.
3. WHEN THE SIDE ROAD LIES BETWEEN THE BEGINNING OF THE MAINLINE SIGNING AND THE WORK ZONE, A SINGLE HEADED ARROW (M6-1) SHALL BE USED IN LIEU OF THE DOUBLE HEADED ARROW (M6-4).

B. FOR A LANE CLOSURE ON A SIDE ROAD OR DRIVEWAY:

- USE APPLICABLE PORTIONS OF THE TYPICAL APPLICATION OF TRAFFIC CONTROL DEVICES (STD. 701501, STD. 701606 OR THE APPROPRIATE STANDARD). THE SPACING OF SIGNS AND BARRICADES SHALL BE ADJUSTED FOR FIELD CONDITIONS AS DIRECTED BY THE ENGINEER. THE DIRECTIONAL ARROW SHALL BE COVERED OR REMOVED WHEN NO LONGER CONSISTENT WITH THE SIDE ROAD LANE CLOSURE.
- C. ADVANCE WARNING SIGNS ARE TO BE OMITTED ON DRIVEWAY UNLESS OTHERWISE NOTED.
- D. THE TRAFFIC CONTROL AND PROTECTION FOR SIDE ROADS, INTERSECTIONS, AND DRIVEWAYS SHALL BE INCIDENTAL TO THE COST OF SPECIFIED TRAFFIC CONTROL STANDARDS OR ITEMS.

All dimensions are in millimeters (inches) unless otherwise shown.

TRAFFIC CONTROL AND PROTECTION FOR SIDE ROADS, INTERSECTIONS AND DRIVEWAYS

FILE NAME =	USER NAME = \$USER\$	DESIGNED -	REVISED -	<b>STATE OF ILLINOIS DEPARTMENT OF TRANSPORTATION</b>	<b>DISTRICT ONE DETAIL SHEETS</b>			F.A.P. RTE.	SECTION	COUNTY	TOTAL SHEETS	SHEET NO.
\$FILEL\$		DRAWN -	REVISED -		<b>IL ROUTE 47 FROM IL ROUTE 176 TO IL ROUTE 120</b>			326	105 RS-9	McHENRY	37	28
		CHECKED -	REVISED -		SCALE: NONE			D-91-603-09			CONTRACT NO. 60H33	
		DATE - 4/2009	REVISED -		SHEET NO. 28 OF 37 SHEETS			STA. 8+85 TO STA. 256+29			FED. ROAD DIST. NO. - ILLINOIS FED. AID PROJECT	

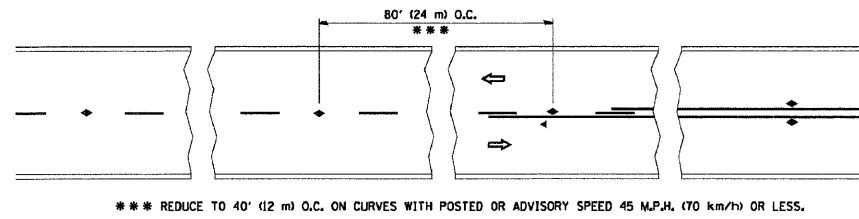

TWO-LANE/TWO-WAY

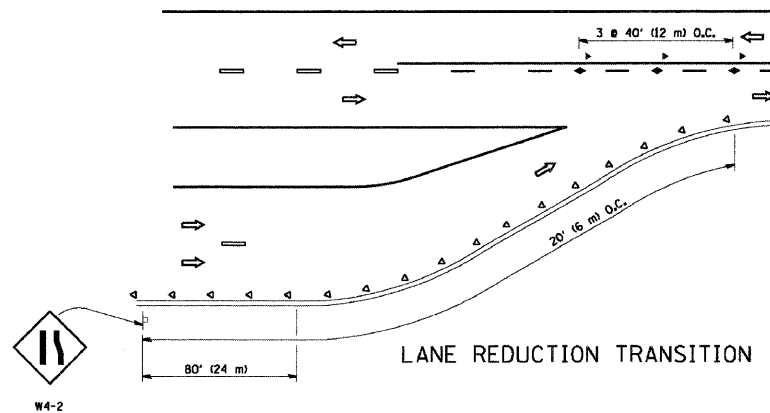

LANE REDUCTION TRANSITION

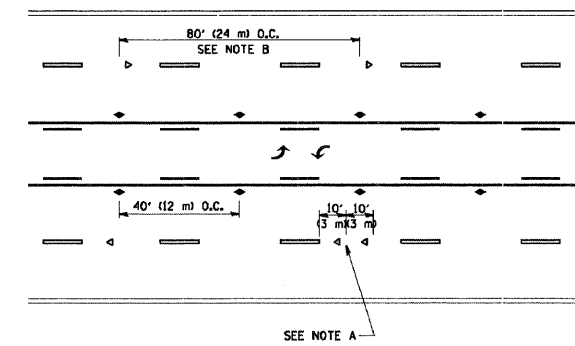

TWO-WAY LEFT TURN

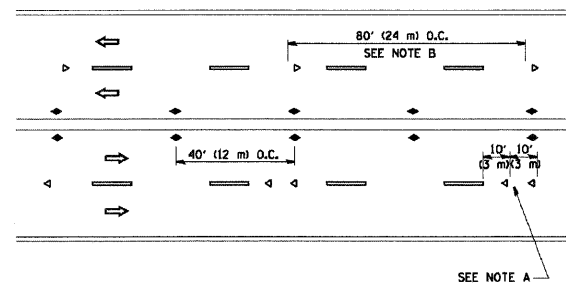

MULTI-LANE/UNDIVIDED

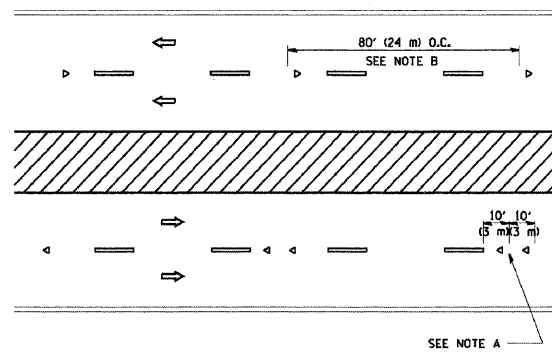

MULTI-LANE/DIVIDED

GENERAL NOTES

1. MARKERS USED WITH DASHED LINES SHALL BE CENTERED IN THE GAP BETWEEN SEGMENTS.
2. MARKERS USED ADJACENT TO SOLID LINES SHALL BE OFFSET 2 TO 3 (50 TO 75) TOWARD TRAFFIC AS SHOWN.
3. MARKERS THROUGH TANGENTS LESS THAN 500' (150 m) IN LENGTH BETWEEN CURVES SHALL BE INSTALLED AT THE LESSER OF THE TWO CURVE SPACINGS.

SYMBOLS

- YELLOW STRIPE
- WHITE STRIPE
- ◀ ONE-WAY AMBER MARKER
- ◀ ONE-WAY CRYSTAL MARKER (W/O)
- ◀ TWO-WAY AMBER MARKER

LANE MARKER NOTES

- A. USE DOUBLE LANE LINE MARKERS SPACED AS SHOWN.
- B. REDUCE TO 40' (12 m) O.C. ON CURVES WHERE ADVISORY SPEEDS ARE 10 M.P.H (20 km/h) LOWER THAN POSTED SPEEDS.

DESIGN NOTES

1. DOUBLE LANE LINE MARKERS SHALL BE USED UNLESS SPECIFIED OTHERWISE.
2. EXCEPT AS SHOWN ON THE LANE REDUCTION TRANSITION AND FREEWAY EXIT RAMP DETAIL, MARKERS ARE NOT TO BE SPECIFIED ON RIGHT EDGE LINES.
3. THE EXACT MARKER LIMITS, SPACING, AND COLOR SHOULD BE INCLUDED IN THE PLANS.
4. MARKERS SHOULD NOT BE USED ALONGSIDE CURBS EXCEPT FOR EXTREMELY SHORT SECTIONS OF CURBS WHERE NOT MORE THAN TWO MARKERS WOULD BE INVOLVED.

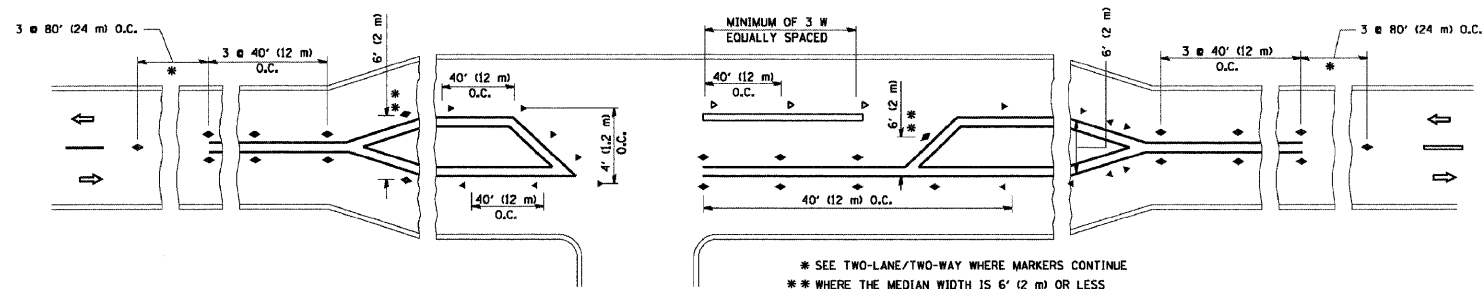

LEFT TURN

All dimensions are in inches (millimeters) unless otherwise shown.

**RAISED REFLECTIVE PAVEMENT MARKERS (SNOW PLOW RESISTANT)**

FILE NAME =	USER NAME = \$USER\$	DESIGNED -	REVISED -	<b>STATE OF ILLINOIS DEPARTMENT OF TRANSPORTATION</b>	<b>DISTRICT ONE DETAIL SHEETS</b>			F.A.P. RTE.	SECTION	COUNTY	TOTAL SHEETS	SHEET NO.
\$FILE\$		DRAWN -	REVISED -		<b>IL ROUTE 47 FROM IL ROUTE 176 TO IL ROUTE 120</b>			326	105 RS-9	McHENRY	37	29
		CHECKED -	REVISED -		SCALE: NONE			SHEET NO. 29 OF 37 SHEETS			CONTRACT NO. 60H33	
		DATE - 4/2009	REVISED -		STA. 8+85 TO STA. 256+29			FED. ROAD DIST. NO. - ILLINOIS FED. AID PROJECT				

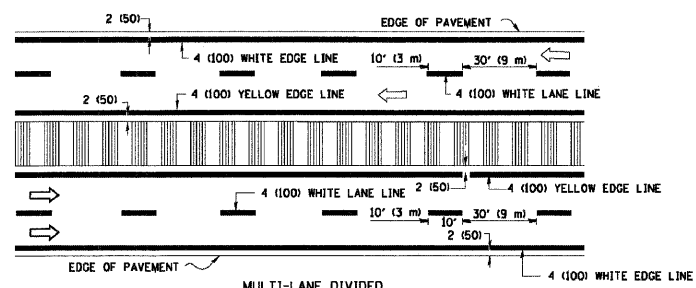
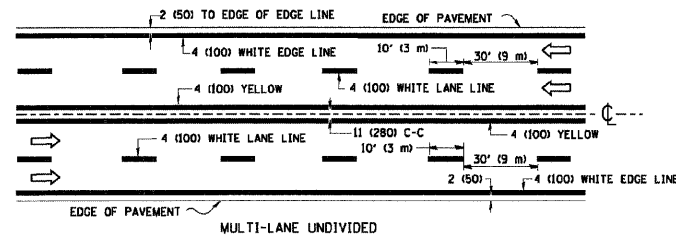
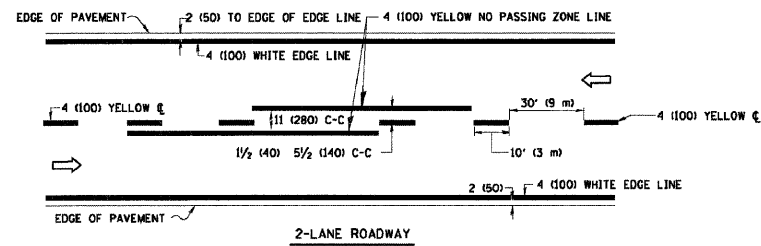

TYPICAL LANE AND EDGE LINE MARKING

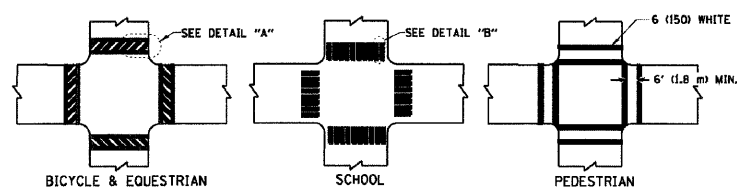

TYPICAL CROSSWALK MARKING

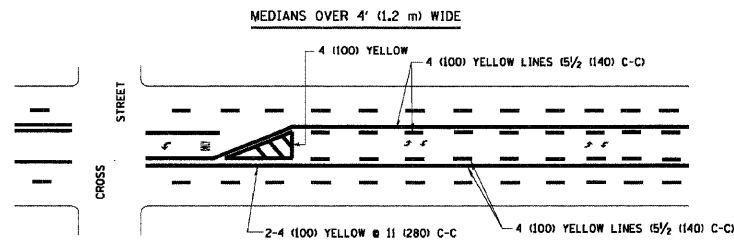
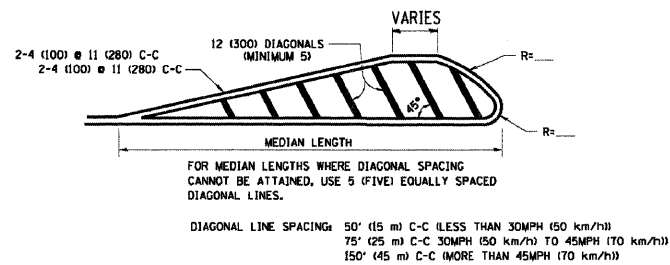
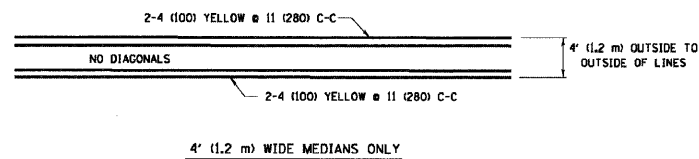

TYPICAL PAINTED MEDIAN MARKING

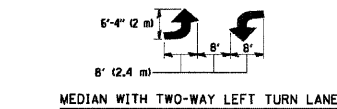

TYPICAL TURN LANE MARKING

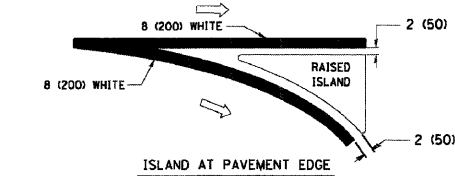
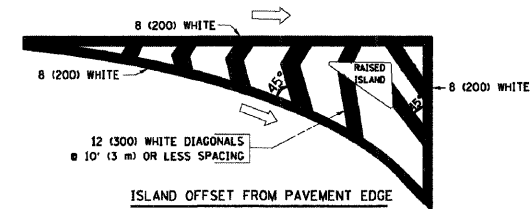

TYPICAL ISLAND MARKING

TYPE OF MARKING	WIDTH OF LINE	PATTERN	COLOR	SPACING / REMARKS
CENTERLINE ON 2 LANE PAVEMENT	4 (100)	SKIP-DASH	YELLOW	10' (3 m) LINE WITH 30' (9 m) SPACE
CENTERLINE ON MULTI-LANE UNDIVIDED PAVEMENT	2 @ 4 (100)	SOLID	YELLOW	11 (280) C-C
NO PASSING ZONE LINES FOR ONE DIRECTION	4 (100)	SOLID	YELLOW	5 1/2 (140) C-C FROM SKIP-DASH CENTERLINE
NO PASSING ZONE LINES FOR BOTH DIRECTIONS	2 @ 4 (100)	SOLID	YELLOW	11 (280) C-C OMIT SKIP-DASH CENTERLINE BETWEEN
LANE LINES	4 (100)	SKIP-DASH	WHITE	10' (3 m) LINE WITH 30' (9 m) SPACE
LANE LINES ON FREEWAYS	5 (125)	SKIP-DASH	WHITE	10' (3 m) LINE WITH 30' (9 m) SPACE
DOTTED LINES (EXTENSIONS OF CENTER, LANE OR TURN LANE MARKINGS)	SAME AS LINE BEING EXTENDED	SKIP-DASH	SAME AS LINE BEING EXTENDED	2' (600) LINE WITH 6' (1.8 m) SPACE
EDGE LINES	4 (100)	SOLID	YELLOW-LEFT WHITE-RIGHT	OUTLINE MOUNTABLE MEDIANS IN YELLOW; EDGE LINES ARE NOT USED NEXT TO BARRIER CURB
TURN LANE MARKINGS	6 (150) LINES; FULL SIZE LETTERS & SYMBOLS 10' (2.4m)	SOLID	WHITE	SEE TYPICAL TURN LANE MARKING DETAIL
TWO WAY LEFT TURN MARKING	2 @ 4 (100) EACH DIRECTION	SKIP-DASH AND SOLID	YELLOW	10' (3 m) LINE WITH 30' (9 m) SPACE FOR SKIP-DASH; 5 1/2 (140) C-C BETWEEN SOLID LINE AND SKIP-DASH LINE
	8' (2.4m) LEFT ARROW	IN PAIRS	WHITE	SEE TYPICAL TWO-WAY LEFT TURN MARKING DETAIL
CROSSWALK LINES (PEDESTRIAN A. DIAGONALS (BIKE & EQUESTRIAN) B. LONGITUDINAL BARS (SCHOOL))	2 @ 6 (150) 12 (300) @ 45° 12 (300) @ 90°	SOLID SOLID	WHITE WHITE	NOT LESS THAN 6' (1.8 m) APART 2' (600) APART SEE TYPICAL CROSSWALK MARKING DETAILS.
STOP LINES	24 (600)	SOLID	WHITE	PLACE 4' (1.2 m) IN ADVANCE OF AND PARALLEL TO CROSSWALK, IF PRESENT. OTHERWISE, PLACE AT DESIRED STOPPING POINT, PARALLEL TO CROSSROAD CENTERLINE, WHERE POSSIBLE
PAINTED MEDIANS	2 @ 4 (100) WITH 12 (300) DIAGONALS @ 45° NO DIAGONALS USED FOR 4' (1.2 m) WIDE MEDIANS	SOLID	YELLOW; TWO WAY TRAFFIC WHITE; ONE WAY TRAFFIC	11 (280) C-C FOR THE DOUBLE LINE SEE TYPICAL PAINTED MEDIAN MARKING.
GORE MARKING AND CHANNELIZING LINES	8 (200) WITH 12 (300) DIAGONALS @ 45°	SOLID	WHITE	DIAGONALS: 15' (4.5 m) C-C (LESS THAN 30MPH (50 km/h)) 20' (6 m) C-C (30MPH (50 km/h) TO 45MPH (70 km/h)) 30' (9 m) C-C (OVER 45MPH (70 km/h))
RAILROAD CROSSING	24 (600) TRANSVERSE LINES; "RR" IS 6' (1.8 m) LETTERS; 16 (400) LINE FOR "X"	SOLID	WHITE	SEE STATE STANDARD 780001 AREA OF: "R"=3.6 SQ. FT. (0.33 m²) EACH "X"=54.0 SQ. FT. (5.0 m²)
SHOULDER DIAGONALS	12 (300) @ 45°	SOLID	WHITE - RIGHT YELLOW - LEFT	50' (15 m) C-C (LESS THAN 30MPH (50 km/h)) 75' (23 m) C-C (30 MPH (50 km/h) TO 45MPH (70 km/h)) 150' (45 m) C-C (OVER 45MPH (70 km/h))

FOR FURTHER DETAILS ON PAVEMENT MARKING REFER TO STANDARD SPECIFICATIONS FOR ROAD AND BRIDGE CONSTRUCTION AND STATE STANDARD 780001.

All dimensions are in inches (millimeters) unless otherwise shown.

## DISTRICT ONE TYPICAL PAVEMENT MARKINGS



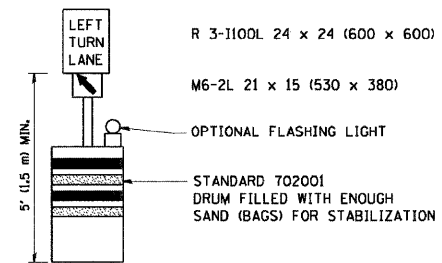
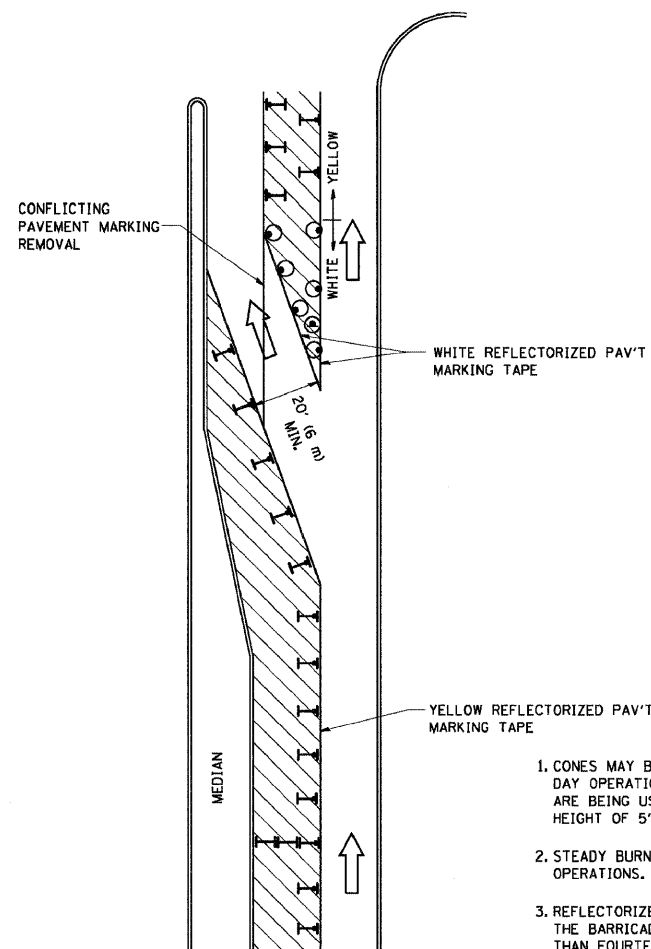



FILE NAME =	USER NAME = \$USER\$	DESIGNED -	REVISED -	STATE OF ILLINOIS DEPARTMENT OF TRANSPORTATION	DISTRICT ONE DETAIL SHEETS			F.A.P. RTE.	SECTION	COUNTY	TOTAL SHEETS	SHEET NO.
\$FILEL\$		DRAWN -	REVISED -		IL ROUTE 47 FROM IL ROUTE 176 TO IL ROUTE 120			326	105 RS-9	MCHENRY	37	30
		CHECKED -	REVISED -		SCALE: NONE			D-91-603-09			CONTRACT NO. 60H33	
		DATE - 4/2009	REVISED -		SHEET NO. 30 OF 37 SHEETS			STA. 8+85 TO STA. 256+29			FED. ROAD DIST. NO. [ILLINOIS] FED. AID PROJECT	



**GENERAL NOTES**

1. CONES MAY BE SUBSTITUTED FOR BARRICADES OR DRUMS AT HALF THE SPACING DURING DAY OPERATIONS. CONES SHALL BE A MINIMUM OF 28 (710) IN HEIGHT. WHEN CONES ARE BEING USED, THE "LEFT TURN LANE" SIGN MAY BE SKID MOUNTED AT A MINIMUM HEIGHT OF 5' (1.5 m).
2. STEADY BURNING LIGHTS WILL NOT BE REQUIRED ON BARRICADES OR DRUMS FOR DAY OPERATIONS. ALL LIGHTS SHALL BE MONODIRECTIONAL.
3. REFLECTORIZED TEMPORARY PAVEMENT MARKING TAPE SHALL BE PLACED THROUGHOUT THE BARRICADED AREA OF EACH TURN BAY WHERE THE CLOSURE TIME IS GREATER THAN FOURTEEN DAYS.
4. THIS APPLICATION ALSO APPLIES WHEN WORK IS BEING PERFORMED IN THE RIGHT LANE(S) AND THE RIGHT TURN BAY IS TO REMAIN OPEN. UNDER THIS CONDITION, "RIGHT TURN LANE" R3-100 24 x 24 (600 x 600) AND M6-2R 21 x 15 (530 x 380) SHALL BE USED.
5. THESE CONTROLS SHALL SUPPLEMENT MAINLINE TRAFFIC CONTROL FOR LANE CLOSURES.
6. LONGITUDINAL DIMENSIONS MAY BE ADJUSTED TO FIT FIELD CONDITIONS.
7. FORM BT 725 IS REQUIRED.
8. TRAFFIC CONTROL AND PROTECTION AT TURN BAYS (TO REMAIN OPEN TO TRAFFIC) SHALL BE INCLUDED IN THE COST SPECIFIED TRAFFIC CONTROL STANDARDS OR ITEMS.

**LEGEND**

-  WORK AREA
-  LANE OPEN TO TRAFFIC
-  TYPE I OR II BARRICADE WITH STEADY BURN LIGHT
-  DRUM WITH STEADY BURN LIGHT
-  DRUM WITH SIGN (WITH OPTIONAL FLASHING LIGHT) SEE DETAIL
-  TYPE I OR II CHECK BARRICADE WITH FLASHING LIGHT

All dimensions are in inches (millimeters) unless otherwise shown.

**TRAFFIC CONTROL AND PROTECTION AT TURN BAYS (TO REMAIN OPEN TO TRAFFIC)**

FILE NAME = #FILE#	USER NAME = #USER#	DESIGNED - ---	REVISED - -----	<b>STATE OF ILLINOIS DEPARTMENT OF TRANSPORTATION</b>	<b>DISTRICT ONE DETAIL SHEETS</b>			F.A.P. RTE.	SECTION	COUNTY	TOTAL SHEETS	SHEET NO.
	PLOT SCALE = #SCALE#	DRAWN - ---	REVISED - -----		326	105 RS-9	McHENRY	37	31			
PLOT DATE = #DATE#	CHECKED - ---	REVISED - -----	IL ROUTE 47 FROM IL ROUTE 176 TO IL ROUTE 120			D-91-603-09		CONTRACT NO. 60H33				
	DATE - 4/2009	REVISED - -----	SCALE: NONE		SHEET NO. 31 OF 37 SHEETS	STA. 8+85 TO STA. 256+29	FED. ROAD DIST. NO. ILLINOIS FED. AID PROJECT					

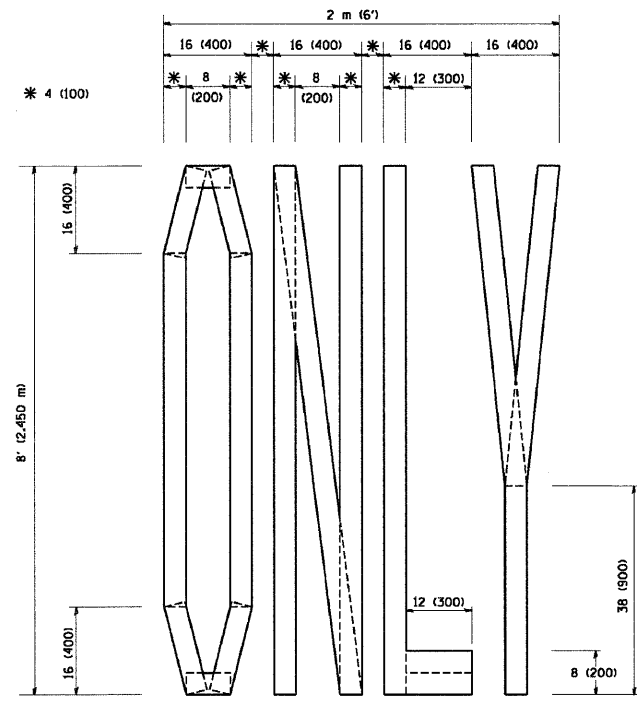

QUANTITY  
 4 (100) LINE = 64.1 ft. (19.7 m)  
 21.1 sq. ft. (1.97 sq. m)

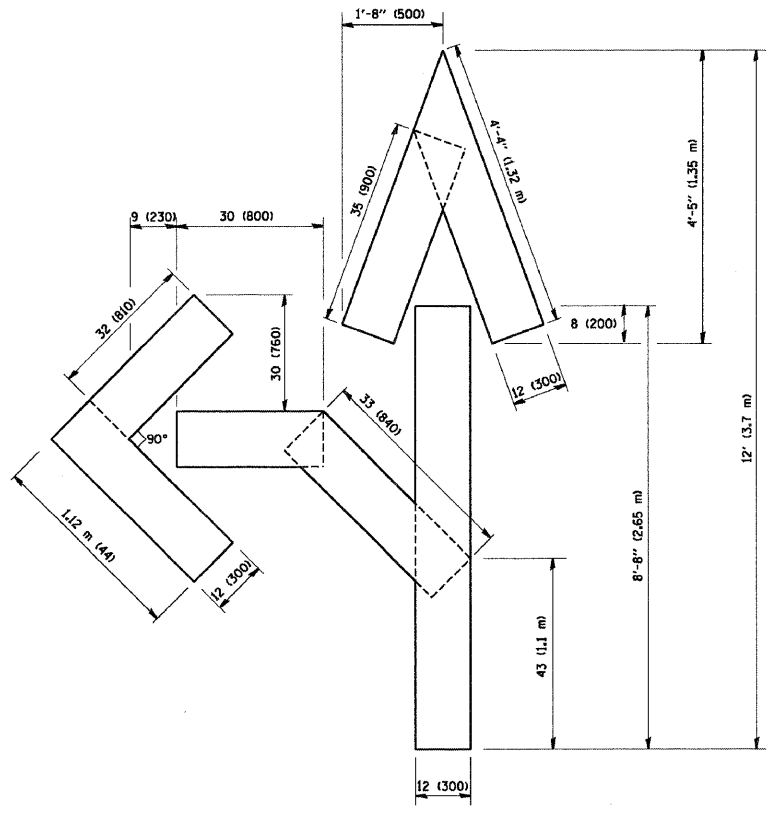

QUANTITY  
 4 (100) LINE = 82.5 ft. (25.3 m)  
 27.5 sq. ft. (2.53 sq. m)

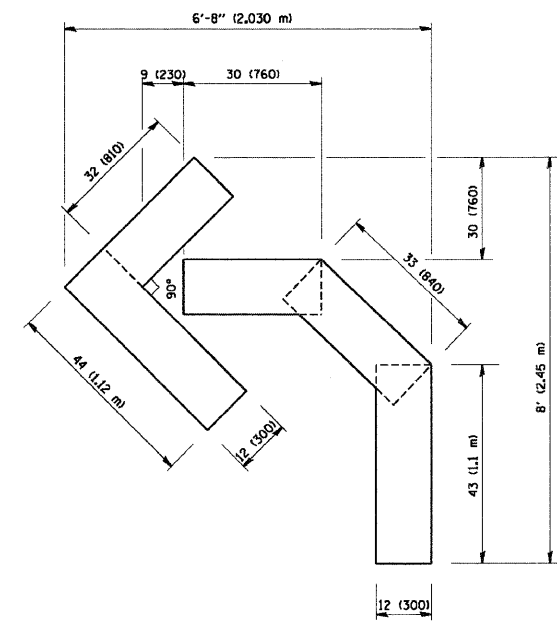

QUANTITY  
 4 (100) LINE = 45.5 ft. (13.9 m)  
 15.2 sq. ft. (1.39 sq. m)

All dimensions are in inches (millimeters) unless otherwise shown.

### PAVEMENT MARKING LETTERS AND SYMBOLS FOR TRAFFIC STAGING

FILE NAME =	USER NAME = #USER#	DESIGNED -	REVISED -	<b>STATE OF ILLINOIS DEPARTMENT OF TRANSPORTATION</b>	<b>DISTRICT ONE DETAIL SHEETS IL ROUTE 47 FROM IL ROUTE 176 TO IL ROUTE 120</b>			F.A.P. RTE. 326	SECTION 105 RS-9	COUNTY McHENRY	TOTAL SHEETS 37	SHEET NO. 32
#FILEL#		DRAWN -	REVISED -		SCALE: NONE	SHEET NO. 32 OF 37 SHEETS	STA. 8+85 TO STA. 256+29	D-91-603-09		CONTRACT NO. 60H33		
		CHECKED -	REVISED -					FED. ROAD DIST. NO. ILLINOIS FED. AID PROJECT				
		DATE - 4/2009	REVISED -									



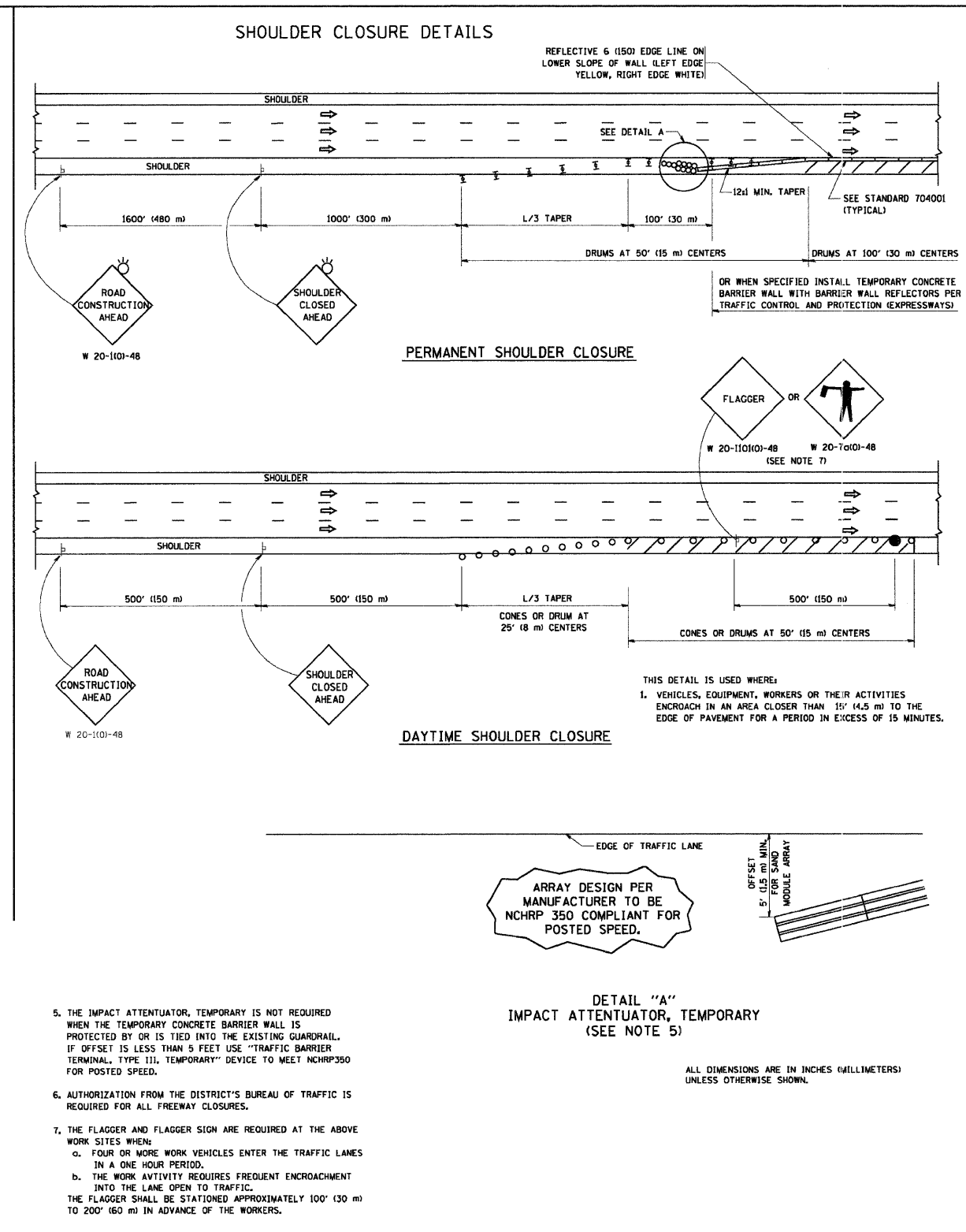
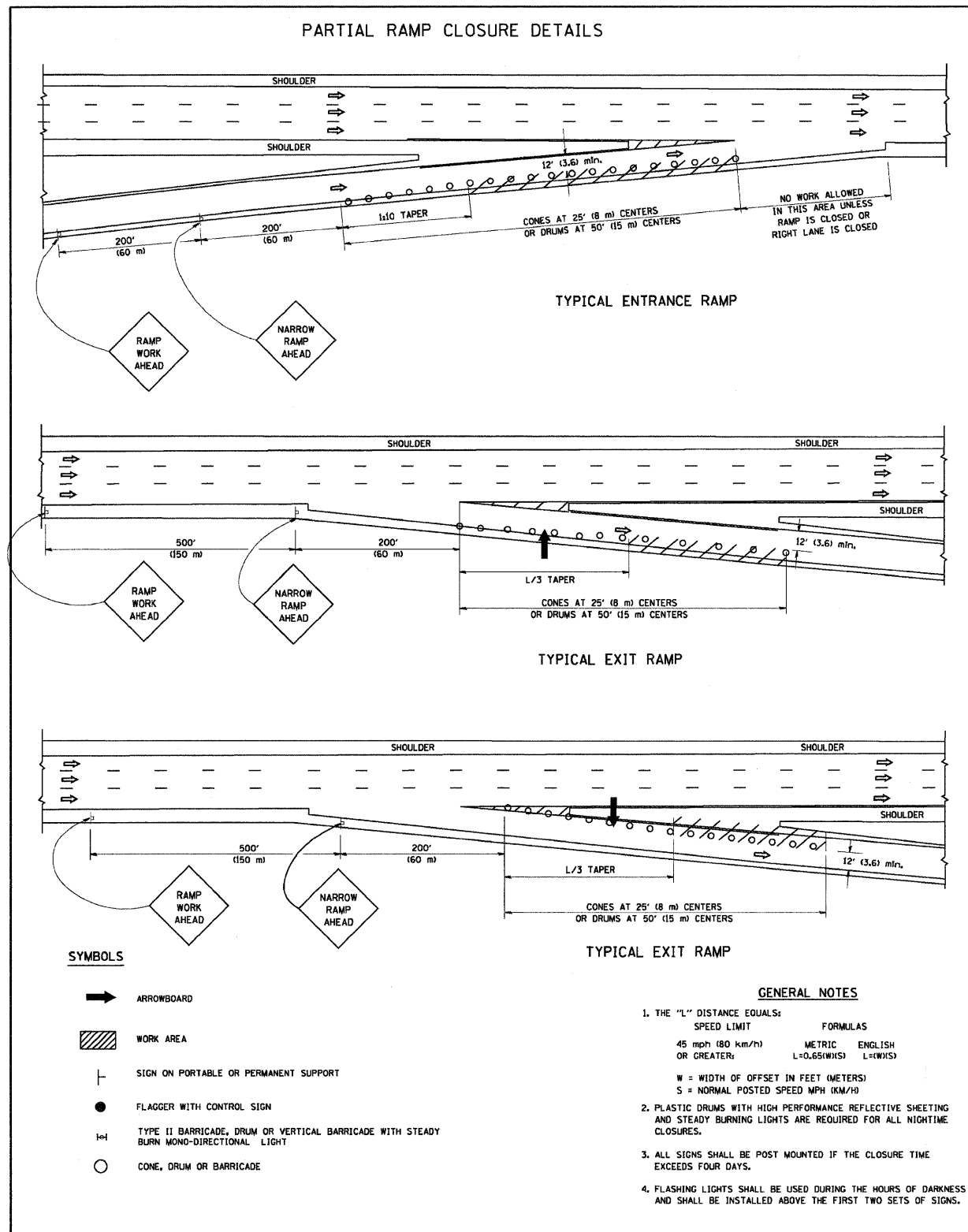

## TRAFFIC CONTROL FOR SHOULDER CLOSURES AND PARTIAL RAMP CLOSURES

FILE NAME = \$FILEL\$	USER NAME = \$USER\$	DESIGNED - ---	REVISED - -----	<b>STATE OF ILLINOIS DEPARTMENT OF TRANSPORTATION</b>	<b>DISTRICT ONE DETAIL SHEETS</b>			F.A.P. RTE. 326	SECTION 105 RS-9	COUNTY MCHENRY	TOTAL SHEETS 37	SHEET NO. 33
	PLOT SCALE = \$SCALE\$	CHECKED - ---	REVISED - -----		IL ROUTE 47 FROM IL ROUTE 176 TO IL ROUTE 120			D-91-603-09			CONTRACT NO. 60H33	
PLOT DATE = \$DATE\$	DATE - 4/2009	REVISED - -----	REVISED - -----	SCALE: NONE			SHEET NO. 33 OF 37 SHEETS	STA. 8+85 TO STA. 256+29		FED. ROAD DIST. NO. [ILLINOIS] FED. AID PROJECT		

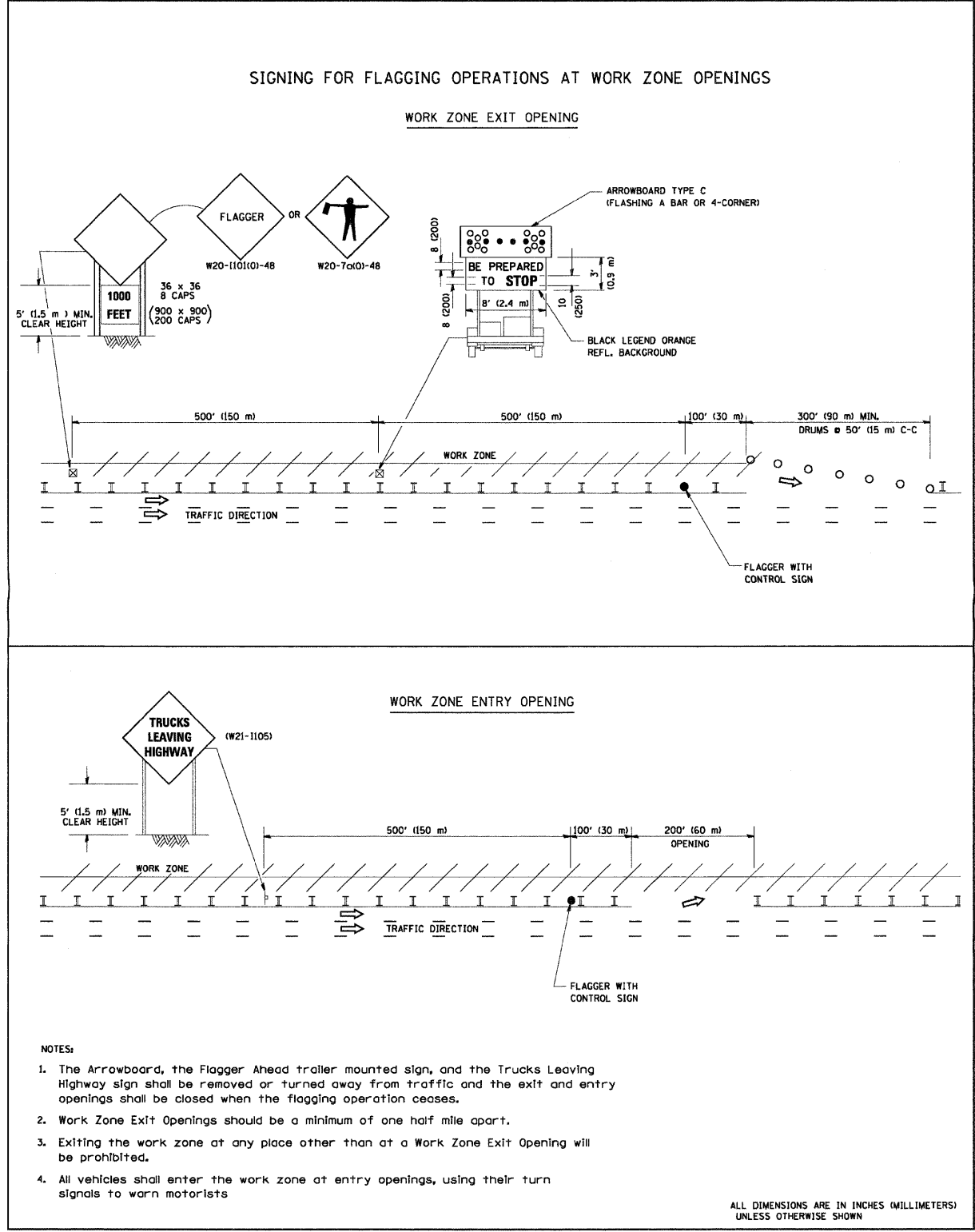

### SIGNING FOR FLAGGING OPERATIONS AT WORK ZONE OPENINGS

FILE NAME =	USER NAME = \$USER\$	DESIGNED - ---	REVISED - ---	<b>STATE OF ILLINOIS DEPARTMENT OF TRANSPORTATION</b>	<b>DISTRICT ONE DETAIL SHEETS</b>			F.A.P. RTE.	SECTION	COUNTY	TOTAL SHEETS	SHEET NO.
FILE#		DRAWN - ---	REVISED - ---		IL ROUTE 47 FROM IL ROUTE 176 TO IL ROUTE 120	326	105 RS-9	McHENRY	37	34		
		CHECKED - ---	REVISED - ---		SCALE: NONE	SHEET NO. 34 OF 37 SHEETS	STA. 8+85 TO STA. 256+29	D-91-603-09		CONTRACT NO. 60H33		
		DATE - 4/2009	REVISED - ---						FED. ROAD DIST. NO. _ ILLINOIS FED. AID PROJECT			

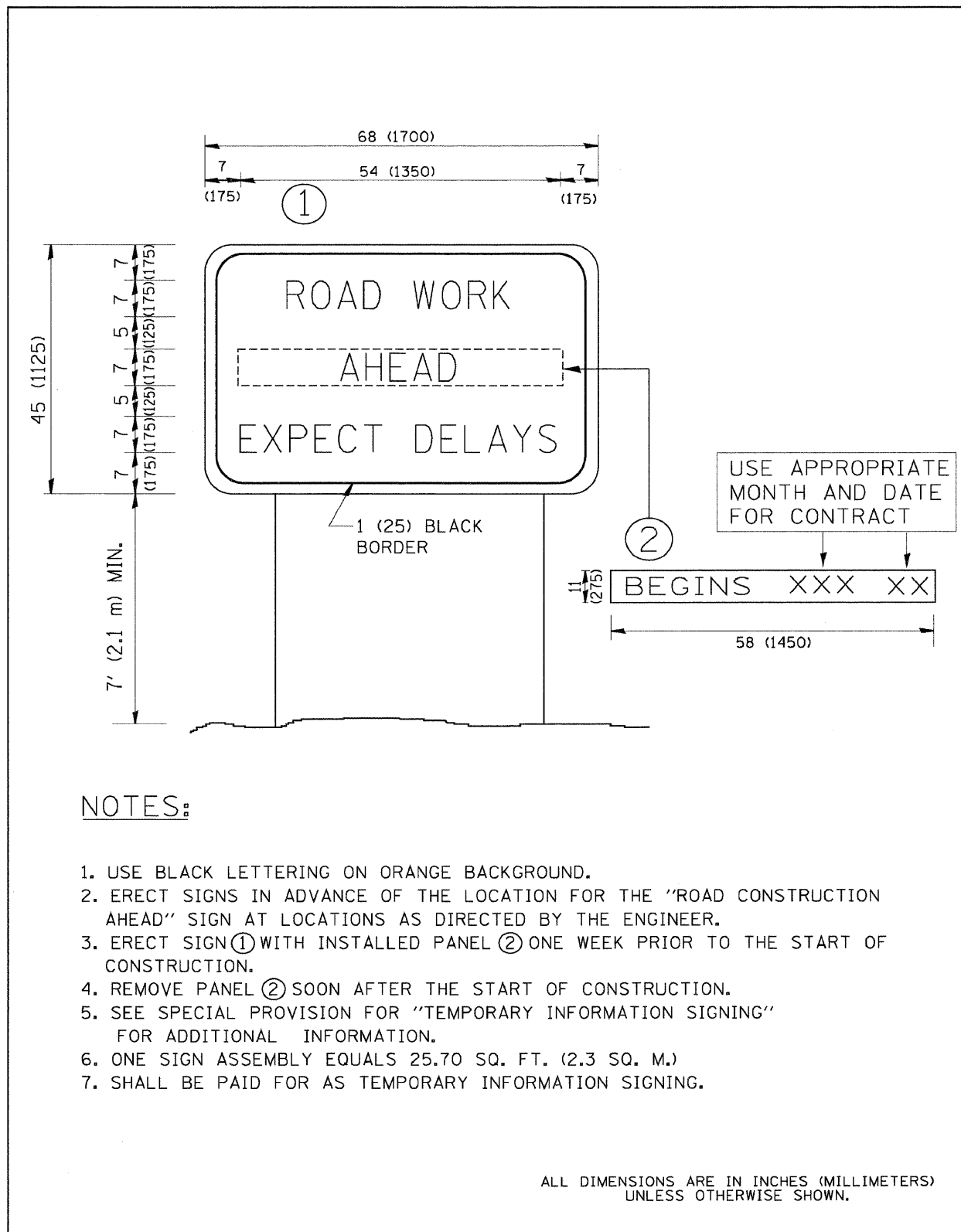

**NOTES:**

1. USE BLACK LETTERING ON ORANGE BACKGROUND.
2. ERECT SIGNS IN ADVANCE OF THE LOCATION FOR THE "ROAD CONSTRUCTION AHEAD" SIGN AT LOCATIONS AS DIRECTED BY THE ENGINEER.
3. ERECT SIGN ① WITH INSTALLED PANEL ② ONE WEEK PRIOR TO THE START OF CONSTRUCTION.
4. REMOVE PANEL ② SOON AFTER THE START OF CONSTRUCTION.
5. SEE SPECIAL PROVISION FOR "TEMPORARY INFORMATION SIGNING" FOR ADDITIONAL INFORMATION.
6. ONE SIGN ASSEMBLY EQUALS 25.70 SQ. FT. (2.3 SQ. M.)
7. SHALL BE PAID FOR AS TEMPORARY INFORMATION SIGNING.

ALL DIMENSIONS ARE IN INCHES (MILLIMETERS) UNLESS OTHERWISE SHOWN.

**ARTERIAL ROAD SIGN INFORMATION**

FILE NAME = #FILE#	USER NAME = #USER#	DESIGNED - ---	REVISED - ---	<b>STATE OF ILLINOIS DEPARTMENT OF TRANSPORTATION</b>	<b>DISTRICT ONE DETAIL SHEETS</b>			F.A.P. RTE.	SECTION	COUNTY	TOTAL SHEETS	SHEET NO.
		DRAWN - ---	REVISED - ---		<b>IL ROUTE 47 FROM IL ROUTE 176 TO IL ROUTE 120</b>			326	105 RS-9	McHENRY	37	35
		CHECKED - ---	REVISED - ---		SCALE: NONE   SHEET NO. 35 OF 37 SHEETS   STA. 8+85 TO STA. 256+29			<b>D-91-603-09</b>		<b>CONTRACT NO. 60H33</b>		
		DATE - 4/2009	REVISED - ---		FED. ROAD DIST. NO. - ILLINOIS FED. AID PROJECT							

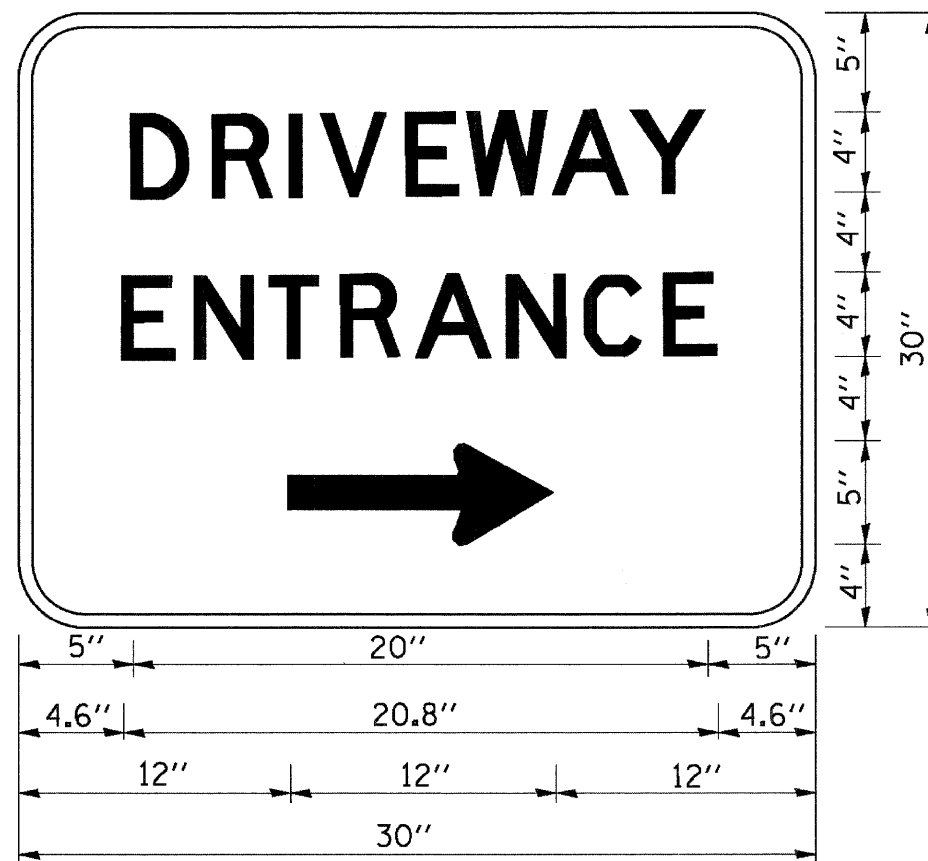

3.0" RADIUS, 0.5" BORDER, WHITE ON GREEN; REFLECTORIZED  
 "DRIVEWAY" D; "ENTRANCE" D; STANDARD ARROW CUSTOM 12.0" x 5.0"

**NOTES:**

1. HALF OF THE SIGNS WILL REQUIRE A LEFT HAND FACING ARROW.
2. TWO SIGNS SHALL BE USED AT EACH COMMERCIAL ENTRANCE PLACED BACK-TO-BACK: ONE WITH A RIGHT HAND ARROW (SHOWN) SHALL BE PLACED ON THE NEAR RIGHT SIDE THE DRIVEWAY AND ONE WITH A LEFT HAND ARROW SHALL BE PLACED ON THE FAR LEFT SIDE OF THE DRIVEWAY.
3. SIGNS TO BE PAID FOR AS ITEM "TEMPORARY INFORMATION SIGNING".

**DRIVEWAY ENTRANCE SIGNING**

FILE NAME =	USER NAME = \$USER\$	DESIGNED -	REVISED -	<b>STATE OF ILLINOIS DEPARTMENT OF TRANSPORTATION</b>	<b>DISTRICT ONE DETAIL SHEETS</b>			F.A.P. RTE.	SECTION	COUNTY	TOTAL SHEETS	SHEET NO.
\$FILEL\$		DRAWN -	REVISED -		<b>IL ROUTE 47 FROM IL ROUTE 176 TO IL ROUTE 120</b>			326	105 RS-9	McHENRY	37	36
		CHECKED -	REVISED -		SCALE: NONE    SHEET NO. 36 OF 37 SHEETS    STA. 8+85 TO STA. 256+29			<b>D-91-603-09</b>		<b>CONTRACT NO. 60H33</b>		
		DATE - 4/2009	REVISED -		FED. ROAD DIST. NO. ILLINOIS FED. AID PROJECT							

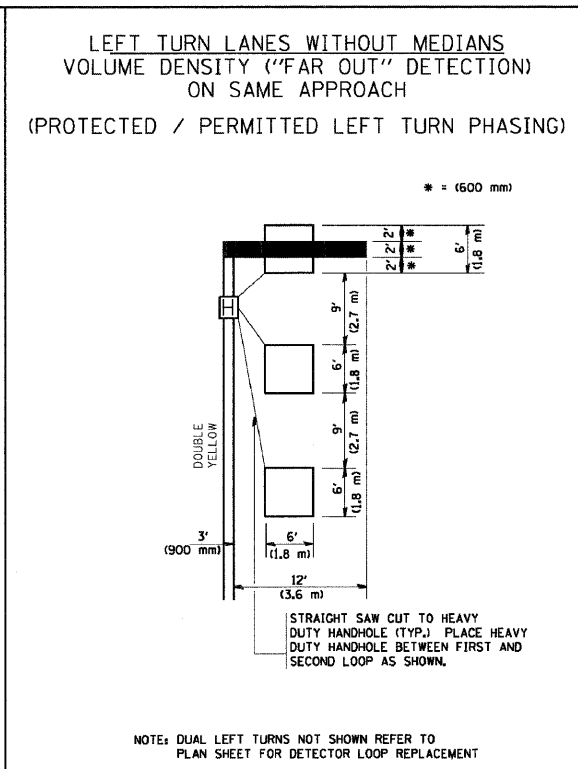
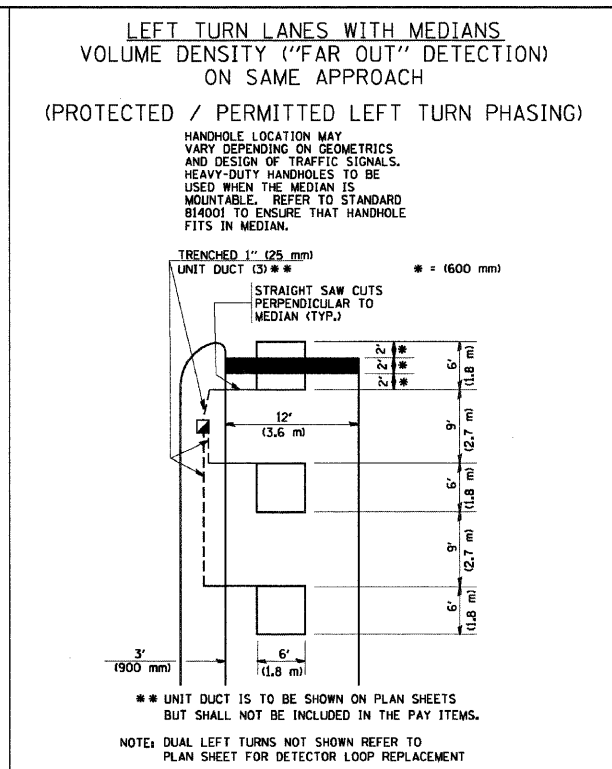
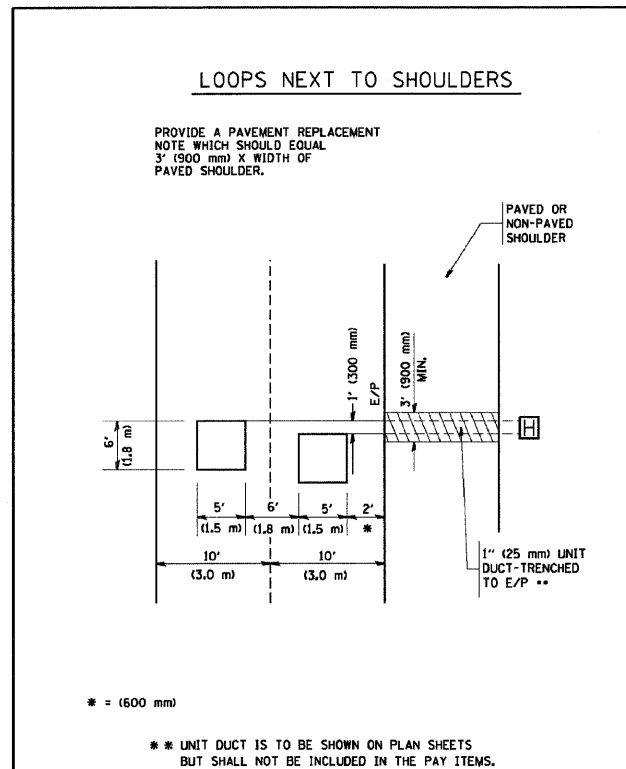

- #### NOTES:
- ##### VEHICLES LOOP DETECTORS
- \* ALL LEAD IN CABLE SHALL BE TWO CONDUCTOR NO. 14 TWISTED, SHIELDED.
  - \* EACH DETECTOR LOOP SHALL HAVE ITS OWN SAW CUT FROM THE LOOP TO THE EDGE OF PAVEMENT OR TO A HANDHOLE IN THE PAVEMENT.
  - \* EACH DETECTOR LOOP SHALL HAVE ITS OWN ONE INCH (25 mm) UNIT DUCT BETWEEN THE EDGE OF PAVEMENT AND THE FIRST HANDHOLE OR JUNCTION BOX. EACH UNIT DUCT RUN SHALL BE SHOWN ON THE PLANS BY THE DESIGNER, BUT SHALL NOT BE PAID FOR SEPARATELY. THIS ITEM IS INCIDENTAL TO THE PAY ITEM FOR DETECTOR LOOPS.
  - \* ONE DIMENSION OF ALL DETECTOR LOOPS SHALL BE SIX FEET (1.8 m)
  - \* EACH LANE OF NON-LOCKING, PRESENCE DETECTION AND EACH LANE OF A DOUBLE LEFT TURN LANE REQUIRES A SEPARATE INDUCTIVE LOOP DETECTOR AND LEAD IN CABLE.
  - \* WHEN NON-LOCKING, PRESENCE DETECTION IS USED, MORE THAN ONE LOOP PER LANE IS REQUIRED BEHIND THE STOP BAR (i.e. 1-1/2, 1-3/4, 2).
  - \* WHEN SYSTEM LOOPS ARE REQUIRED ON AN APPROACH OF AN INTERSECTION, THE LOOPS USED FOR VOLUME DENSITY AND INTERSECTION TIMING SHALL ALSO BE USED AS SYSTEM DETECTORS. EACH ONE OF THESE TYPE OF LOOPS REQUIRES A SEPARATE TWO CONDUCTOR NO. 14 TWISTED SHIELDED CABLE AND A SEPARATE INDUCTIVE LOOP DETECTOR WHEN NEW CONTROLLERS ARE UTILIZED. THE DESIGNER SHALL LABEL THESE TYPES OF LOOPS AS "INTERSECTION AND SAMPLING (SYSTEM) DETECTORS" ON THE SIGNAL LAYOUT, THE INTERCONNECT PLAN AND THE SYSTEM CABLE PLAN. WHEN AN EXISTING CONTROLLER IS UTILIZED FOR THIS TYPE OF DETECTION, THE PAY ITEM "INDUCTIVE LOOP DETECTOR WITH SYSTEM OUTPUT" SHOULD BE USED.

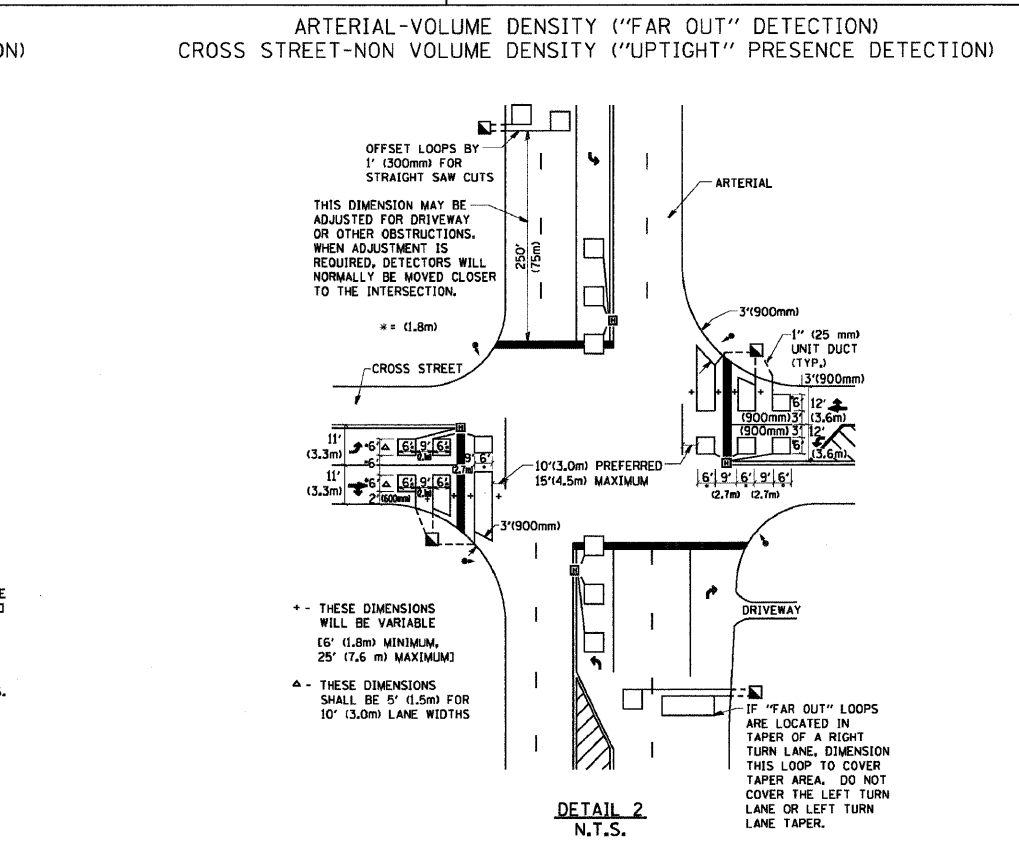
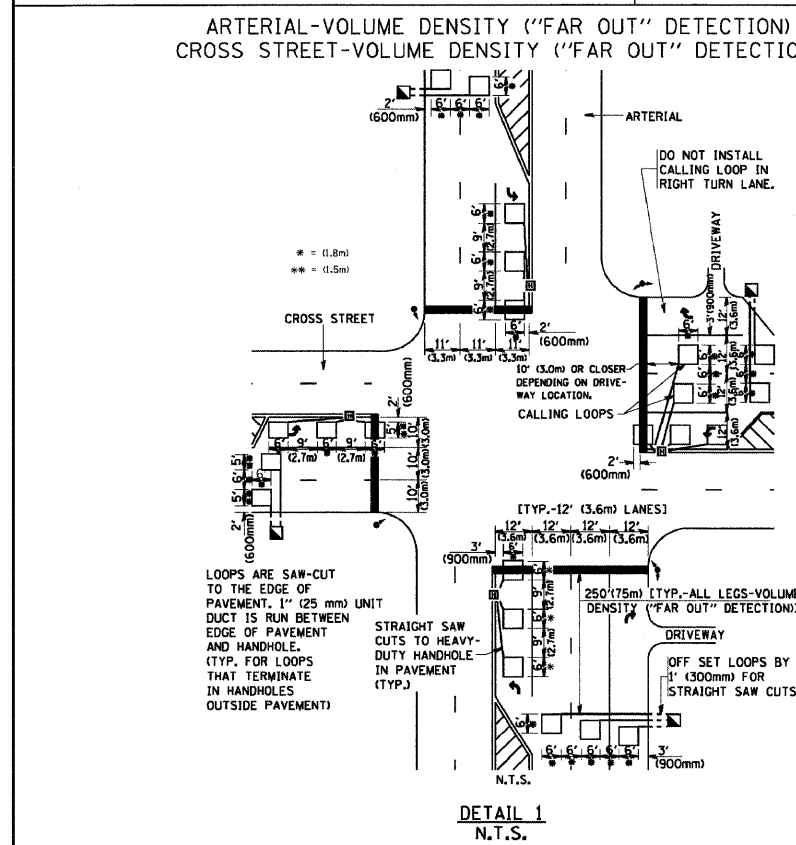

- #### PLACEMENT OF DETECTORS
- THE FOLLOWING FIGURES REPRESENT THE MOST COMMON DETECTOR LOOP LOCATIONS AND SIZES. ADJUSTMENTS WILL BE NECESSARY FOR SPECIFIC GEOMETRIC CONSIDERATIONS.
- LOCATIONS AND DIMENSIONS OF DETECTOR LOOPS ARE REQUIRED ON ALL SIGNAL LAYOUT PLAN SHEETS.
- "FAR OUT" DETECTION REFERS TO LOCKING, PRESENCE TYPE DETECTION LOCATED IN THRU LANES, RIGHT TURN LANES, AND RIGHT TURN LANE TAPER AREAS (IF APPLICABLE), USUALLY 250' (75 m) IN ADVANCE OF STOP BARS. "UPTIGHT" DETECTION REFERS TO NON-LOCKING PRESENCE TYPE DETECTION LOCATED IN ALL LANES AND 10'-15' (3.0 m-4.5 m) BEHIND THE CROSSING STREET'S EDGE OF PAVEMENT EXTENDED.
- NOTE:  
ALL DETAILS AND NOTES SHOWN ARE FROM THE I.D.O.T. DISTRICT 1 TRAFFIC SIGNAL DESIGN GUIDELINES DATED JANUARY 1995
- THIS DRAWING HAS BEEN PREPARED TO ASSIST THE RESIDENT ENGINEER FOR ALL ROADWAY RESURFACING OR S.M.A.R.T. PROJECTS WHERE THE DIMENSIONS ARE NOT SHOWN ON THE PLANS AND THE FINAL LOCATIONS FOR CROSSWALKS OR STOP BARS ARE NOT DETERMINED.

## DETECTOR LOOP INSTALLATION DETAIL FOR ROADWAY RESURFACING

FILE NAME =	USER NAME = #USER#	DESIGNED -	REVISED -	<b>STATE OF ILLINOIS DEPARTMENT OF TRANSPORTATION</b>	<b>DISTRICT ONE DETAIL SHEETS IL ROUTE 47 FROM IL ROUTE 176 TO IL ROUTE 120</b>	F.A.P. RTE. 326	SECTION 105 RS-9	COUNTY MCHENRY	TOTAL SHEETS 37	SHEET NO. 37	
#FILE#		DRAWN -	REVISED -			D-91-603-09		CONTRACT NO. 60H33			
		CHECKED -	REVISED -			SCALE: NONE		SHEET NO. 37 OF 37 SHEETS		STA. 8+85 TO STA. 256+29	
		DATE - 4/2009	REVISED -			FED. ROAD DIST. NO. ILLINOIS FED. AID PROJECT					