

# EROSION CONTROL DETAILS FOR SILT FENCE

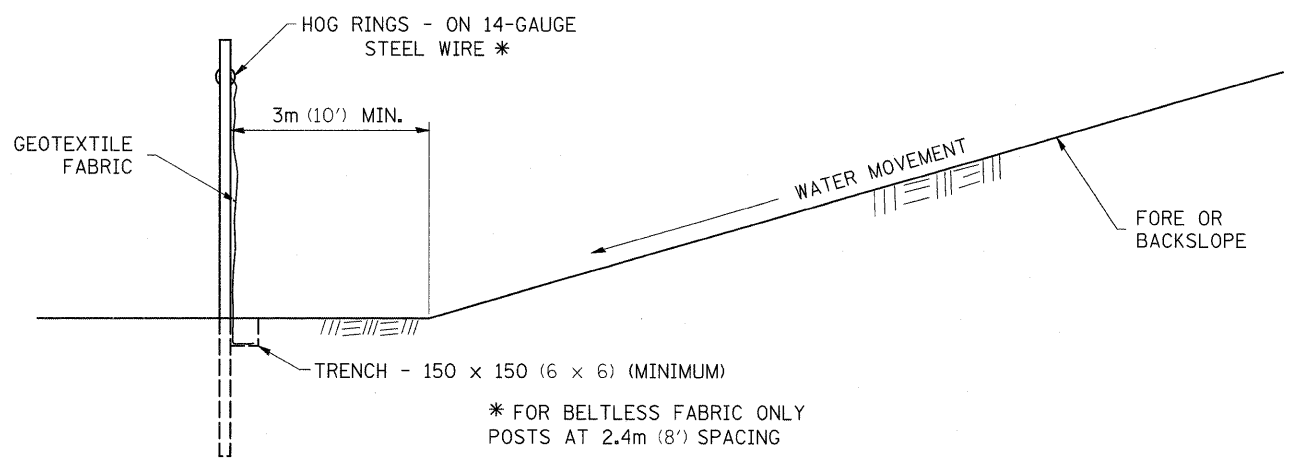
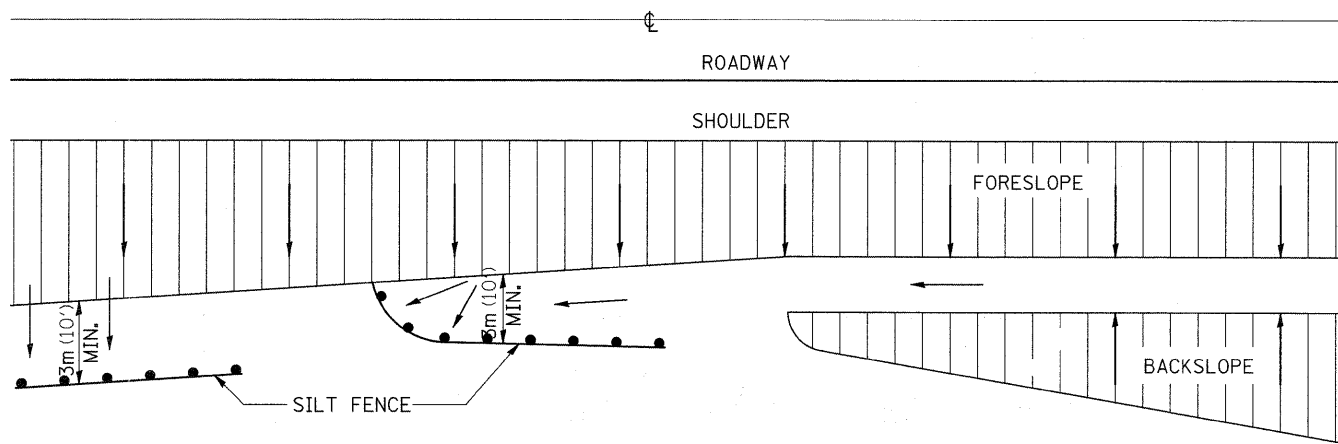

DETAILS OF SILT FENCE

ALL DIMENSIONS ARE IN MILLIMETERS (INCHES) UNLESS OTHERWISE NOTED.

REVISED - 10-22-01

# FIELD TILE JUNCTION VAULTS 600 (24) AND 900 (36) DIA.

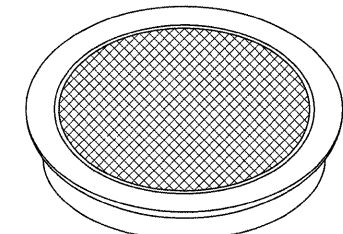

FRAME & LID FOR 600 (24) VAULT

FRAME & LID FOR 900 (36) VAULT

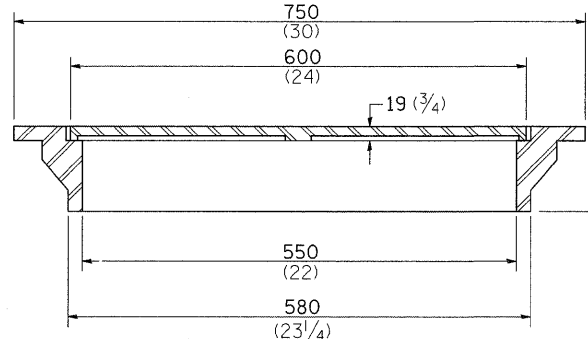

TOTAL WEIGHT: 66 Kg (146 lbs)

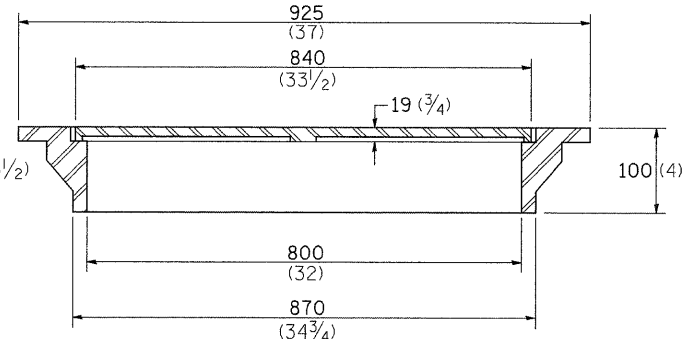

TOTAL WEIGHT: 127 Kg (280 lbs)

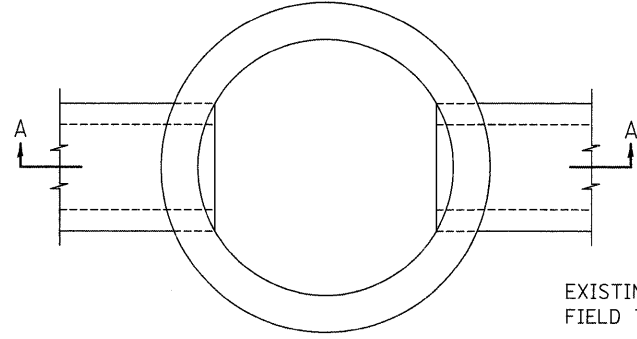

PLAN

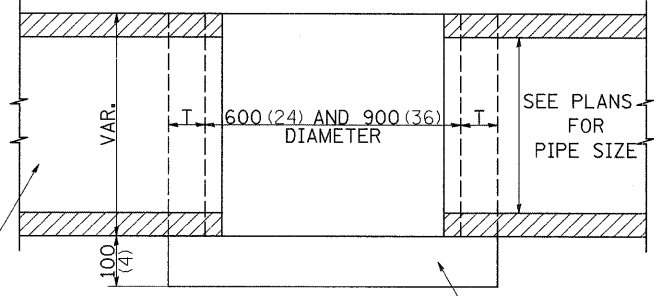

CAST-IN-PLACE CONCRETE SECTION A-A

ALTERNATE MATERIALS FOR WALLS	T
BRICK MASONRY	200 (8)
CAST-IN-PLACE CONCRETE	150 (6)
CONCRETE MASONRY UNIT	125 (5)
PRECAST REINFORCED CONCRETE SECTION	75 (3)

NOTE: THE FRAME AND LID IS REQUIRED ON ALL JUNCTION VAULTS.

ALL DIMENSIONS ARE IN MILLIMETERS (INCHES) UNLESS OTHERWISE NOTED.

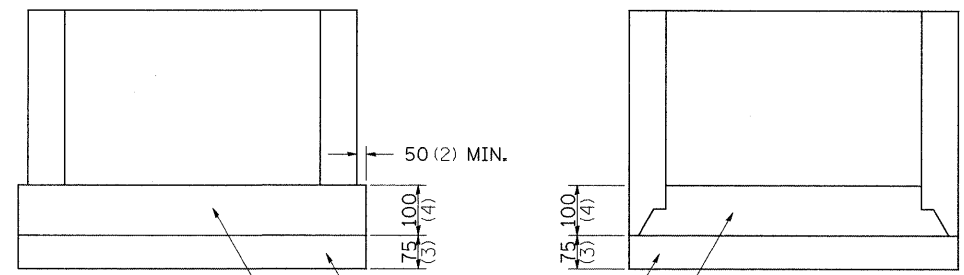

PRECAST REINFORCED CONCRETE SLAB

SAND CUSHION

PREFABRICATED CONCRETE SLAB, WHEN THE PRECAST REINFORCED CONCRETE SECTION ALTERNATE IS USED.

ALTERNATE METHODS

REVISED - 5-03-94	<b>REGION 2 / DISTRICT 2 STANDARD</b>	F.A.P. RTE.	SECTION	COUNTY	TOTAL SHEETS	SHEET NO.
REVISED -		316	2T	OGLE	48	37
REVISED -		CONTRACT NO. 64851				
REVISED -		SCALE: 50.0000' / IN	SHEET NO.	OF SHEETS	STA.	TO STA.