

F.A.D. RTE.	SECTION	COUNTY	TOTAL SHEETS	SHEET NO.
312	(630.853)A54	COOK	31	20E
STA.		TO STA.		
FED. ROAD DIST. NO.		ILLINOIS FED. AID PROJECT		
CONTRACT # 62019				

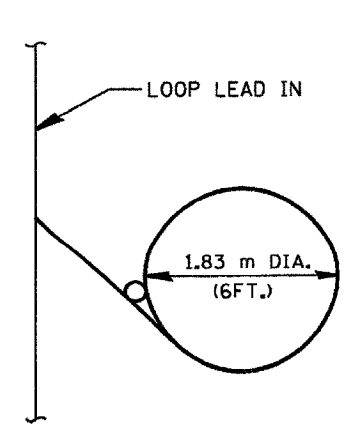

TYPICAL LOOP SAWCUT LAYOUT

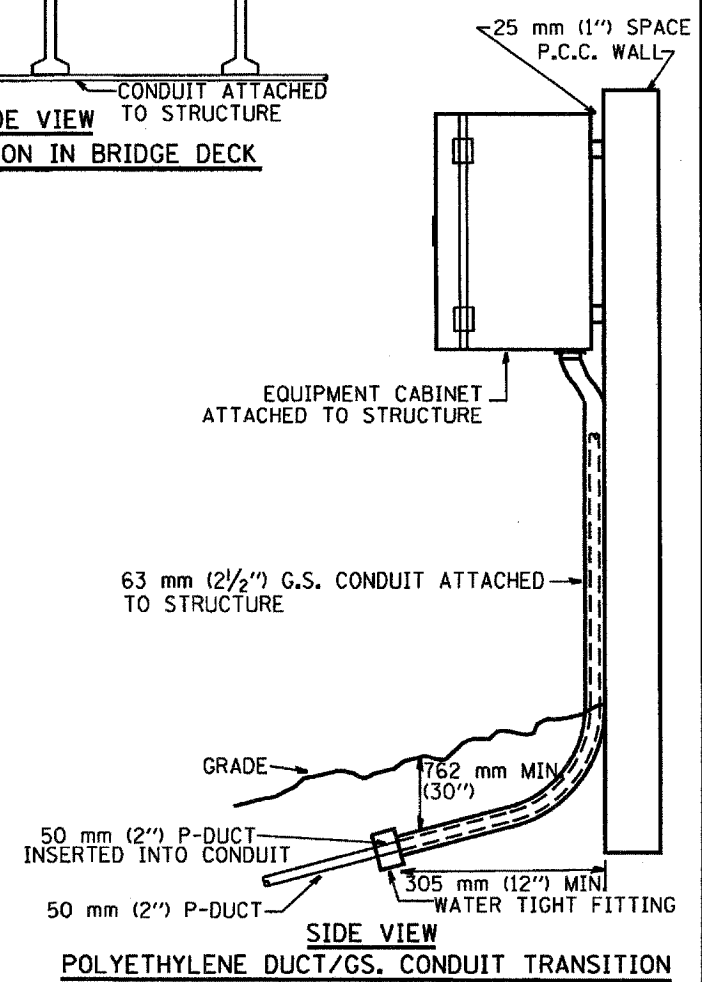
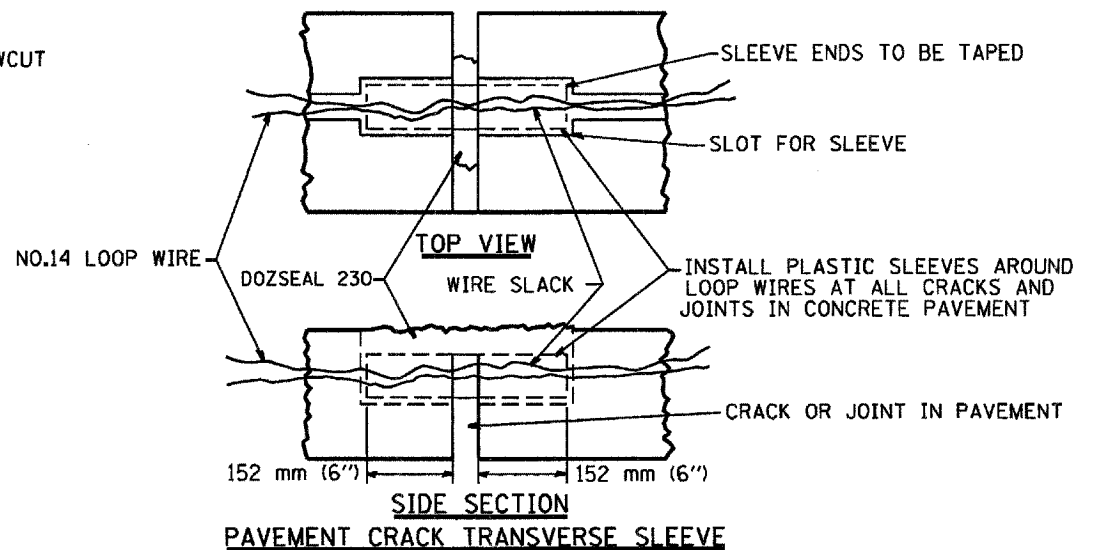
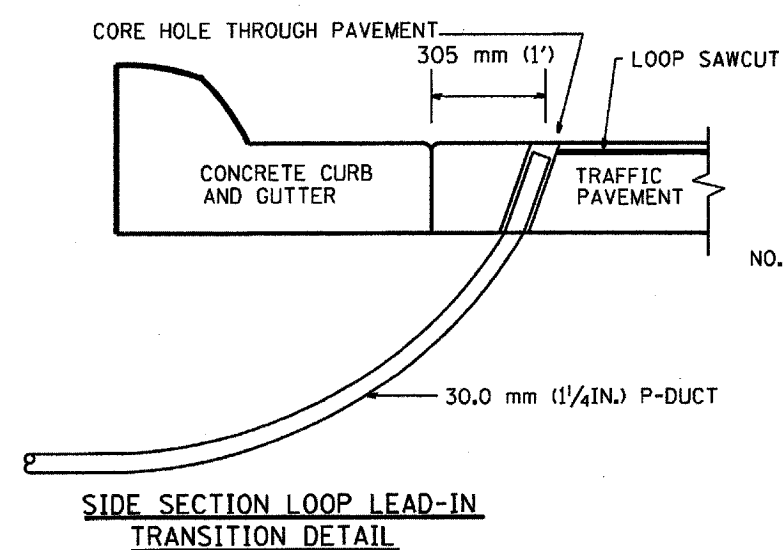
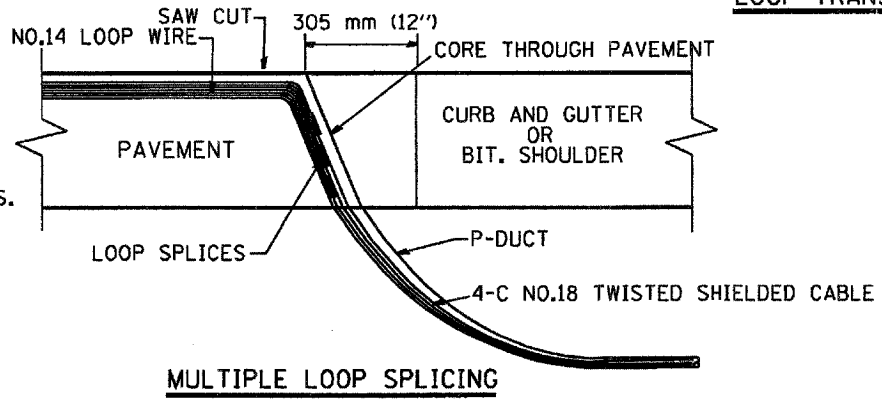
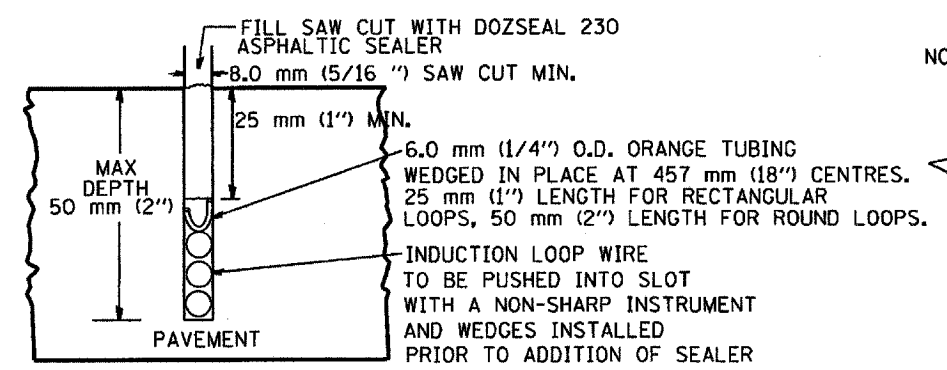
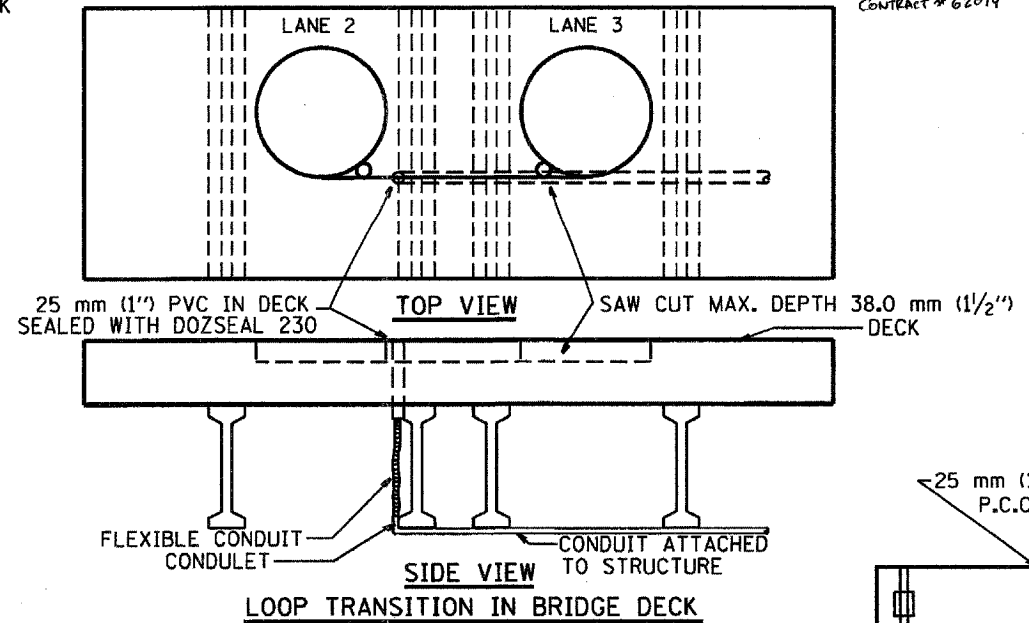
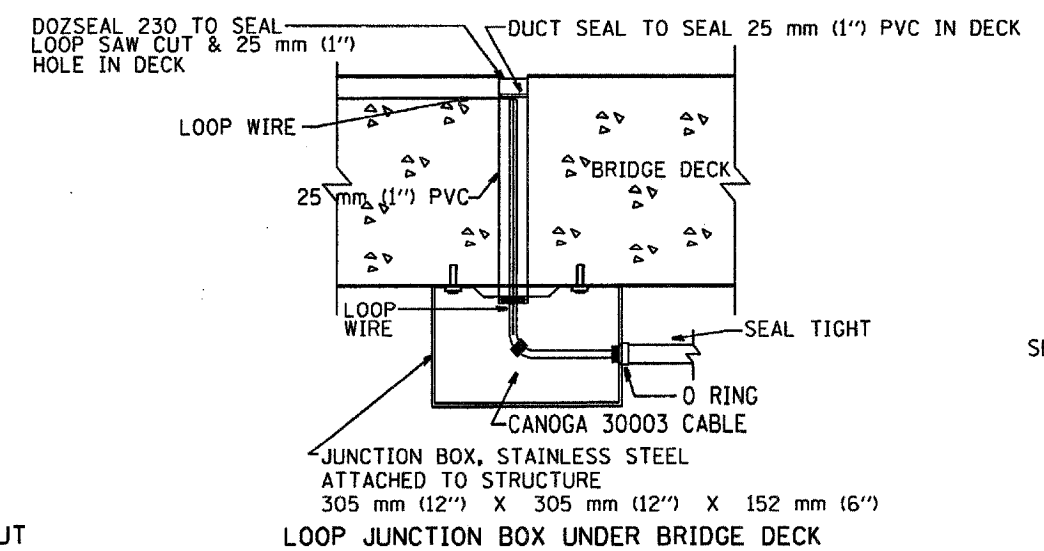

REVISIONS	
NAME	DATE
R.L.	6/94
R.L.	3/96
T.C.	11/96
R.L.	05/96
T.C.	10/96

ILLINOIS DEPARTMENT OF TRANSPORTATION  
TRAFFIC SYSTEMS CENTER

**LOOP, CONDUIT & DUCT  
INSTALLATION DETAILS**

SCALE: VERT. NONE  
HORIZ. DATE 6-22-94

DRAWN BY G.M.  
CHECKED BY R.L.

RD-TYPNET.DGN  
RF

VI-4184