

STATE OF ILLINOIS
DEPARTMENT OF TRANSPORTATION

CONTRACT: 78040
ROUTE: F.A.I. 57
SECTION: (02-1B-1)P-1
COUNTY: ALEXANDER, IL; MISSISSIPPI, MO
SHEET 62 OF 67
FOR INFORMATION ONLY

FRONT STOOL SUPPORT

Mark	L	M	N	P	Q
ST1	1'-1"	1'-6 1/4"	1'-11 1/4"	1'-6 1/4"	1'-1 3/4"
ST2	9"	1'-9 1/4"	2'-0"	1'-11 1/2"	8 3/4"
ST3	1'-1"	1'-6 1/4"	1'-11 1/4"	1'-11 1/4"	8 3/4"
ST4	1'-7 1/4"	1'-7 1/2"	1'-7 1/2"	1'-7 3/4"	8 1/2"
ST5	8 1/2"	1'-7 3/4"	1'-7 1/2"	1'-7 1/2"	1'-7 1/4"
ST6	8 3/4"	1'-11 1/4"	1'-11 1/4"	1'-6 1/4"	1'-1"
ST7	8 3/4"	1'-11 1/2"	2'-0"	1'-9 1/4"	9"
ST8	1'-1 3/4"	1'-6 1/4"	1'-11 1/4"	1'-6 1/4"	1'-1"

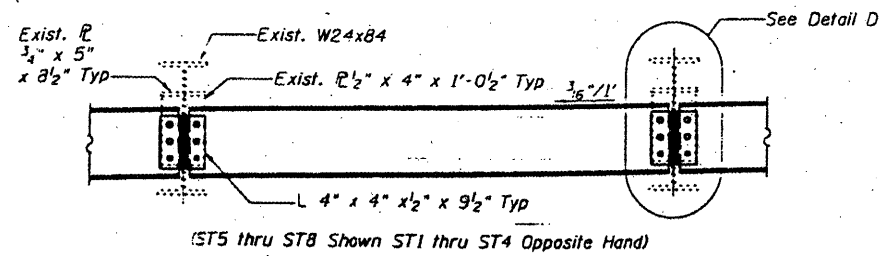
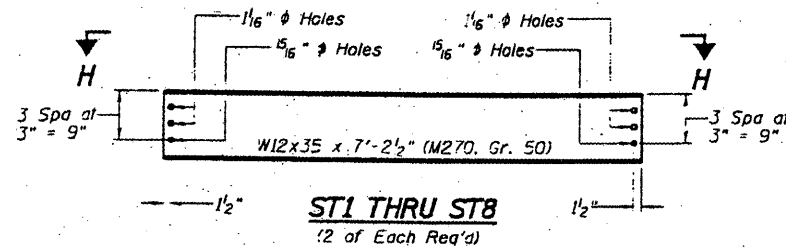
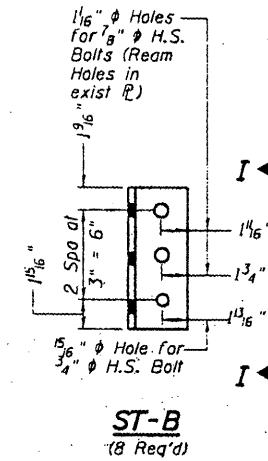
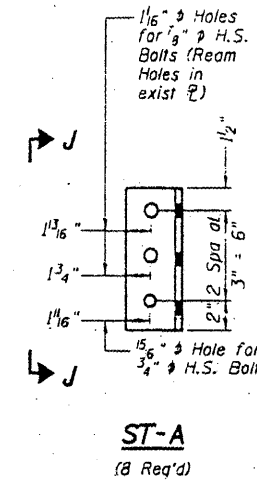
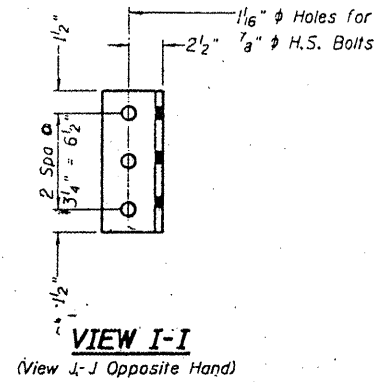
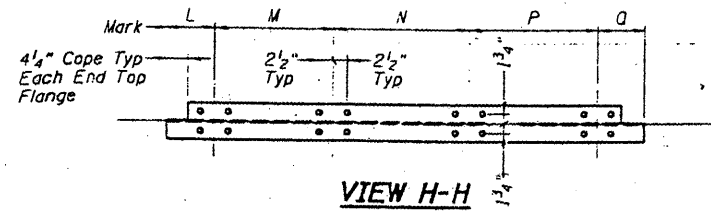

FRONT STOOL SUPPORT - SPANS 12 AND 14

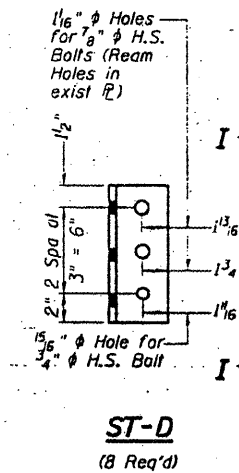
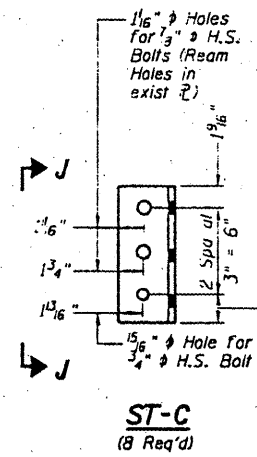
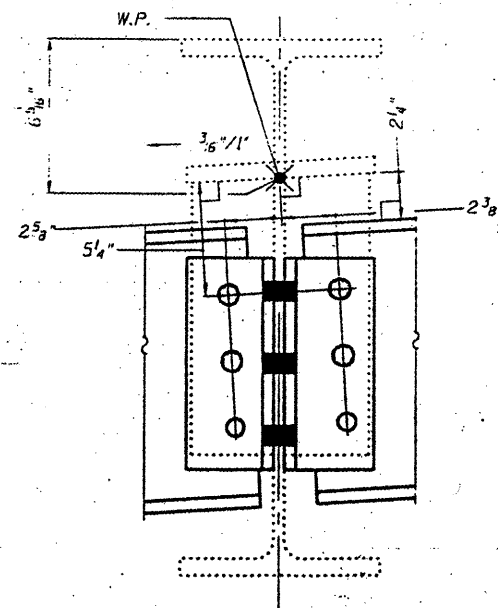

DESIGNED P.S.J.
CHECKED A.T.H.
DRAWN Draw Christopher
CHECKED P.S.J. A.T.H.

EXAMINED *John A. Morris*
ENGINEER OF STRUCTURAL SERVICES
PASSED

BRIDGE NO. 1
STRUCTURE NO. 002-0022
FOR INFORMATION ONLY

STOOL SUPPORT DETAILS
F.A.I. 57 OVER MISSISSIPPI RIVER
ALEXANDER COUNTY
S.N. 002-0022