

06-13-14 LETTING ITEM 038

STATE OF ILLINOIS
DEPARTMENT OF TRANSPORTATION
DIVISION OF HIGHWAYS

**PROPOSED
HIGHWAY PLANS**

FOR INDEX OF SHEETS, SEE SHEET NO. 2

THIS PROJECT IS LOCATED IN:
THE VILLAGE OF ALGONQUIN
THE VILLAGE OF CARY
THE VILLAGE OF HEBRON
THE VILLAGE OF LAKE IN THE HILLS
THE VILLAGE OF PRAIRIE GROVE
THE VILLAGE OF RICHMOND
THE CITY OF CRYSTAL LAKE
THE CITY OF HARVARD
THE CITY OF MARENGO
THE CITY OF MCHENRY
THE CITY OF WOODSTOCK

VARIOUS ROUTES
SECTION: 2014-027RS
VARIOUS LOCATIONS IN MCHENRY COUNTY
INTERMITTENT RESURFACING
MCHENRY COUNTY
C-91-303-14

FOR GENERAL LOCATION MAP, SEE SHEET NO. 4

F.A. RTE.	SECTION	COUNTY	TOTAL SHEETS	SHEET NO.
VAR.	2014-027RS	MCHENRY	33	1
		ILLINOIS	CONTRACT NO. 60Y13	

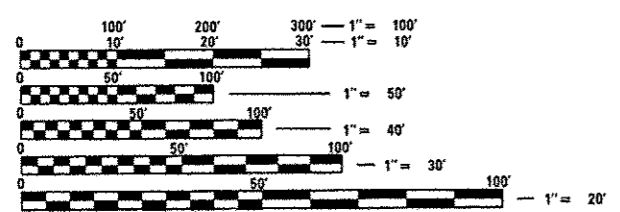
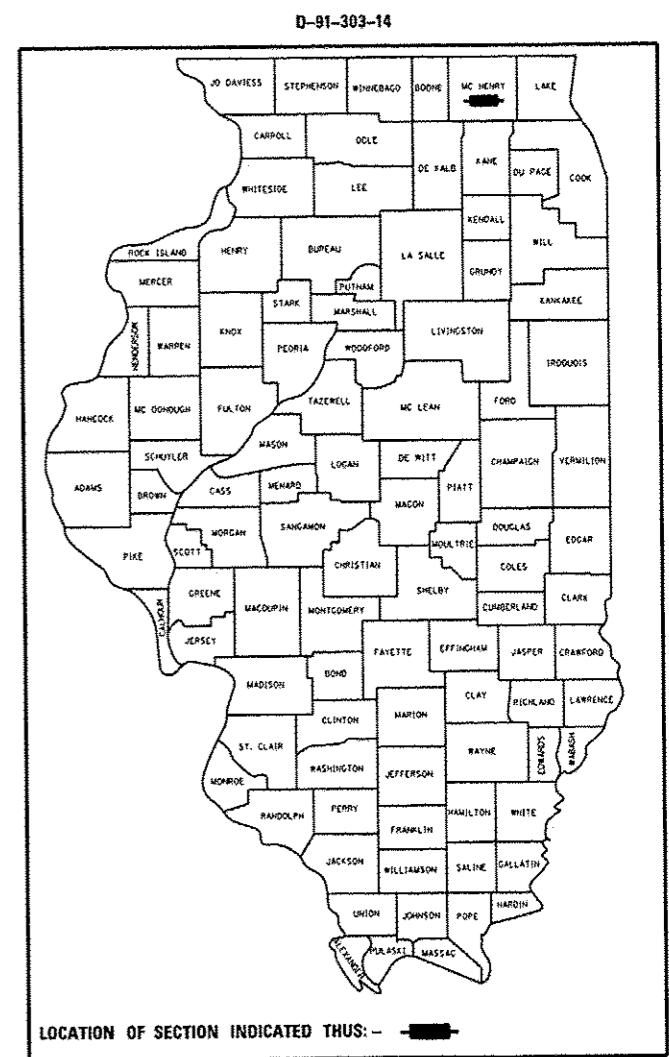

FULL SIZE PLANS HAVE BEEN PREPARED USING STANDARD ENGINEERING SCALES. REDUCED SIZED PLANS WILL NOT CONFORM TO STANDARD SCALES. IN MAKING MEASUREMENTS ON REDUCED PLANS, THE ABOVE SCALES MAY BE USED.

J.U.L.I.E.
JOINT UTILITY LOCATION INFORMATION FOR EXCAVATION
1-800-892-0123
OR 811

PROJECT ENGINEER: DANIEL WILGREEN (847) 705-4240
PROJECT MANAGER: KEN ENG (847) 705-4247

CONTRACT NO. 60Y13

STATE OF ILLINOIS
DEPARTMENT OF TRANSPORTATION
DIVISION OF HIGHWAYS

SUBMITTED April 3 2014

John Ferguson
DEPUTY DIRECTOR OF HIGHWAYS, REGION ENGINEER

Man 9 20 14
Dan P. Bonanni P.E.
ENGINEER OF DESIGN AND ENVIRONMENT

Man 9 20 14
Orin O'Mara P.E.
DIRECTOR OF HIGHWAYS, CHIEF ENGINEER

PRINTED BY THE AUTHORITY
OF THE STATE OF ILLINOIS

INDEX OF SHEETS

STATE STANDARDS

GENERAL NOTES

SHEET NO.	DESCRIPTION	STANDARD NO.	DESCRIPTION
1	TITLE SHEET	000001-06	TYPICAL SYMBOLS, ABBREVIATIONS AND PATTERNS
2	INDEX OF SHEETS, STATE STANDARDS AND GENERAL NOTES	701011-04	OFF-RD MOVING OPERATIONS, 2L, 2W, DAY ONLY
3	SUMMARY OF QUANTITIES	701301-04	LANE CLOSURE, 2L, 2W, SHORT TIME OPERATIONS
4	GENERAL LOCATION MAP	701306-03	LANE CLOSURE, 2L, 2W, SLOW MOVING OPERATIONS - DAY ONLY
5	ROUTE INFORMATION	701311-03	LANE CLOSURE 2L, 2W MOVING OPERATIONS - DAY ONLY
6	SUMMARY OF INTERMITTENT RESURFACING SCHEDULE	701336-06	LANE CLOSURE, 2L, 2W, WORK AREAS IN SERIES
7-24	INTERMITTENT RESURFACING SCHEDULE	701421-06	LANE CLOSURE, MULTILANE, DAY OPERATIONS ONLY, FOR SPEEDS ≥ 45 MPH TO 55 MPH
25	BUTT JOINT AND HMA TAPER DETAILS (BD-32)	701426-06	LANE CLOSURE, MULTILANE, INTERMITTENT OR MOVING OPERATIONS, FOR SPEEDS ≥ 45 MPH
26	TRAFFIC CONTROL AND PROTECTION FOR SIDE ROADS, INTERSECTIONS AND DRIVEWAYS (TC-10)	701427-02	LANE CLOSURE, MULTILANE, INTERMITTENT OR MOVING OPER., FOR SPEEDS ≤ 40 MPH
27	TYPICAL APPLICATIONS: RAISED REFLECTIVE PAVEMENT MARKERS (SNOW-PLOW RESISTANT) (TC-11)	701501-06	URBAN LANE CLOSURE, 2L, 2W, UNDIVIDED
28	DISTRICT ONE TYPICAL PAVEMENT MARKINGS (TC-13)	701502-06	URBAN LANE CLOSURE, 2L, 2W, WITH BIDIRECTIONAL LEFT TURN LANE
29	TRAFFIC CONTROL AND PROTECTION OF TURN BAYS (TO REMAIN OPEN TO TRAFFIC) (TC-14)	701601-09	URBAN LANE CLOSURE, MULTILANE, 1W OR 2W WITH NONTRAVERSABLE MEDIAN
30	PAVEMENT MARKING LETTERS AND SYMBOLS FOR TRAFFIC STAGING (TC-16)	701602-07	URBAN LANE CLOSURE, MULTILANE, 2W WITH BIDIRECTIONAL LEFT TURN LANE
31	ARTERIAL ROAD INFORMATION SIGN (TC-22)	701606-09	URBAN LANE CLOSURE, MULTILANE, 2W WITH MOUNTABLE MEDIAN
32	STANDARD TRAFFIC SIGNAL DESIGN DETAILS (TS-05, SHEET 2 OF 7)	701701-09	URBAN LANE CLOSURE, MULTILANE INTERSECTION
33	DETECTOR LOOP INSTALLATION DETAIL FOR ROADWAY RESURFACING (TS-07)	701901-03	TRAFFIC CONTROL DEVICES

BEFORE STARTING ANY EXCAVATION, THE CONTRACTOR SHALL CALL "JULIE" AT (800) 892-0123 OR 811 FOR FIELD LOCATIONS OF BURIED ELECTRIC, TELEPHONE AND GAS FACILITIES. (48 HOUR NOTIFICATION REQUIRED)

THE CONTRACTOR WILL NOT BE ALLOWED TO SET UP A YARD OR FIELD OFFICE ON STATE (OR TOLLWAY) PROPERTY WITHOUT WRITTEN PERMISSION FROM THE DEPARTMENT (OR ISTHA)

ANY PAVEMENT MARKINGS AND RAISED REFLECTIVE PAVEMENT MARKERS OBLITERATED BY MILLING AND RESURFACING OPERATIONS ON SIDE STREETS AND ENTRANCES SHALL BE REPLACED AND PAID FOR IN KIND.

BEFORE BEGINNING ANY WORK, THE CONTRACTOR SHALL RETAIN AND RECORD FOR FUTURE REFERENCE, ALL EXISTING PAVEMENT MARKING LINES (AND RAISED REFLECTIVE PAVEMENT MARKERS) IN ORDER THAT THESE LOCATIONS CAN BE RE-ESTABLISHED FOR STRIPING. EXACT LOCATIONS OF ALL PAVEMENT MARKINGS SHALL BE AS DIRECTED BY THE ENGINEER.

ALL INTERMITTENT RESURFACING LOCATIONS WILL BE DETERMINED IN THE FIELD BY THE ENGINEER.

THE CONTRACTOR SHALL CONTACT THE DISTRICT ONE TRAFFIC CONTROL SUPERVISOR AT (847) 705-4470 A MINIMUM OF 72 HOURS IN ADVANCE OF BEGINNING WORK.

THE ENGINEER SHALL CONTACT WALLY CZARNY, AREA TRAFFIC FIELD ENGINEER AT (773) 685-4342 MINIMUM OF TWO (2) WEEKS PRIOR TO PLACEMENT OF PERMANENT PAVEMENT MARKINGS.

DOUBLE LANE MARKERS ARE TO BE USED AS SHOWN ON THE DISTRICT ONE DETAIL "TYPICAL APPLICATIONS - RAISED REFLECTIVE PAVEMENT MARKERS (SNOW-PLOW RESISTANT)" SHOWN IN THE PLANS.

THE EXISTING ROADWAY TYPICAL SECTION IS ASSUMED TO HAVE A 3 INCH HOT-MIX ASPHALT OVERLAY ON TOP OF A TEN INCH CONCRETE BASE.

ALL INTERMITTENT RESURFACING LOCATIONS SHOWN IN THE PLANS ARE TWO (2) INCH MILL AND RESURFACE ONLY. THE MINIMUM WIDTH FOR INTERMITTENT RESURFACING SHALL BE THREE (3) FEET.

NO PATCHING OR RESURFACING IS TO BE DONE WITHIN FIFTY (50) FEET OF ANY RAILROAD CROSSING.

THE COST OF ANY PARTIAL OR FULL DEPTH PATCHING REQUIRED AFTER THE REMOVAL OF THE EXISTING 2 INCH HOT-MIX ASPHALT SURFACE SHALL BE PAID FOR IN ACCORDANCE WITH ARTICLE 109.04 OF THE STANDARD SPECIFICATIONS.

ANY DETECTOR LOOPS DAMAGED BY MILLING SHALL BE REPLACED IN KIND. IT SHALL BE THE RESPONSIBILITY OF THE CONTRACTOR TO QUANTIFY LOOP REPLACEMENTS NEEDED AND PROVIDE THE RESIDENT ENGINEER THIS INFORMATION PRIOR TO GRINDING OR REMOVAL.

ALL LOOP DETECTOR LOCATIONS SHALL BE CURB MARKED BY THE CONTRACTOR PRIOR TO MILLING FOR THE PURPOSE OF REESTABLISHING DETECTOR LOOP LAYOUT AFTER THE RESURFACING IS COMPLETED.

WHEN MILLED PAVEMENT IS OPEN TO TRAFFIC, THE MAXIMUM GRADE DIFFERENTIAL BETWEEN PASSES OF THE MILLING MACHINE SHALL NOT EXCEED 1 1/2 INCHES (40MM) WHERE THE SPEED LIMIT IS 45 MPH (80 KM/H) OR LESS AND 1 INCH (25 MM) WHERE THE SPEED LIMIT IS GREATER THAN 45 MPH (80 KM/H). WITH WRITTEN APPROVAL FROM THE RESIDENT ENGINEER, A MAXIMUM GRADE DIFFERENTIAL OF 3 INCHES (75 MM) MAY BE ALLOWED IF THE EDGE OF THE MILLING IS SLOPED A MINIMUM OF 1:3 (V:H).

OVERNIGHT LANE CLOSURES SHALL NOT BE ALLOWED FOR REHABILITATION PROJECTS INVOLVING DAYTIME MILLING AND RESURFACING OPERATIONS AND CLASS D PATCHING UNLESS OTHER CONDITIONS WARRANT EXTENDED LANE CLOSURES AS DETERMINED AND APPROVED IN WRITING BY THE ENGINEER OR AS PROVIDED FOR IN THE CONTRACT SPECIFICATIONS. ANY MILLED PAVEMENT IS TO BE RESURFACED BY THE END OF EACH DAY AND OPEN TO TRAFFIC.

HOT-MIX ASPHALT MIXTURE REQUIREMENTS		QUALITY MANAGEMENT PROGRAM (QMP)
MIXTURE TYPE	AIR VOIDS (%) @ N _{DES.}	
HOT-MIX ASPHALT SURFACE COURSE, MIX "D", N70 (IL 9.5MM), 2"	4% @ 70 GYR	QC/QA
QMP DESIGNATION: QUALITY CONTROL/QUALITY ASSURANCE (QC/QA)		

THE UNIT WEIGHT USED TO CALCULATE ALL HMA SURFACE MIXTURE QUANTITIES IS 112 LBS/50 YD/IN.

THE "AC TYPE" FOR POLYMERIZED HMA MIXES SHALL BE "SBS/SBR PG 76-22" AND FOR NON-POLYMERIZED HMA THE "AC TYPE" SHALL BE "PG 64-22" UNLESS MODIFIED BY DISTRICT ONE SPECIAL PROVISIONS. FOR USE OF RECYCLED MATERIALS SEE SPECIAL PROVISIONS. QUALITY MANAGEMENT PROGRAM (QMP) IDENTIFIES THE PARTICULAR QUALITY CONTROL SPECIFICATION THAT APPLIES TO THE HMA MIXTURE

FILE NAME: c:\p-work\p\sdot\pencepl\0302486\1104\101henry.dgn	USER NAME: PencePL	DESIGNED: -	REVISED: -	STATE OF ILLINOIS DEPARTMENT OF TRANSPORTATION	INDEX OF SHEETS, STATE STANDARDS AND GENERAL NOTES	F.A. RTE.	SECTION	COUNTY	TOTAL SHEETS	SHEET NO.
PLOT SCALE: 1/8" = 1'-0"	CHECKED: -	REVISED: -	VAR.			2014-021RS	MCHENRY	33	2	
PLOT DATE: 4/4/2014	DATE: -	REVISED: -	CONTRACT NO. 60Y13							
Default	SCALE: SHEET OF SHEETS STA. TO STA.	ILLINOIS FED. AID PROJECT								

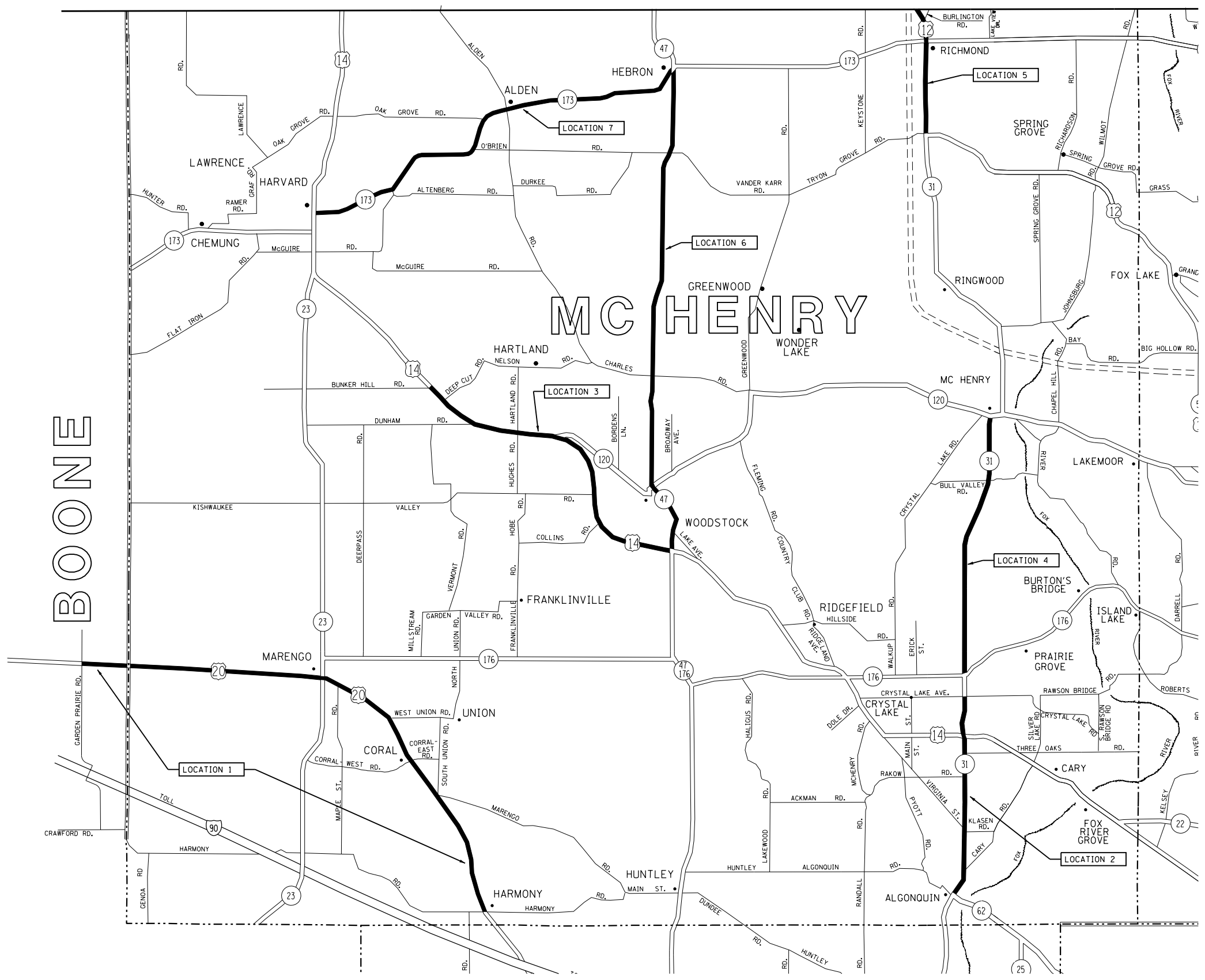

FILE NAME =	USER NAME = Aumm	DESIGNED -	REVISED -
c:\pwork\pwork\dot\Aumm\d0382486\HMA-McHenry.dgn		DRAWN -	REVISED -
Default	PLOT SCALE = 100.0000' / in.	CHECKED -	REVISED -
	PLOT DATE = 4/4/2014	DATE -	REVISED -

**STATE OF ILLINOIS
DEPARTMENT OF TRANSPORTATION**

**GENERAL LOCATION MAP
VARIOUS LOCATIONS IN McHENRY COUNTY**

SCALE: SHEET OF SHEETS STA. TO STA.

F.A. RTE.	SECTION	COUNTY	TOTAL SHEETS	SHEET NO.
VAR.	2014-027RS	MCHEMRY	33	4
			CONTRACT NO. 60Y13	
ILLINOIS FED. AID PROJECT				

	SUMMARY - MCHENRY COUNTY ARTERIAL ROUTES	CITIES/VILLAGES	TOWNSHIPS	SPEED LIMIT	EXISTING ADT (YEAR)
LOC.1	US 20 (GARDEN PRAIRIE RD. TO HARMONY RD.)	MARENGO	BONUS, CORAL, MARENGO, SENECA	30-55 MPH	13,600 (2013)
LOC.2	IL 31 (CRYSTAL LAKE AVE. TO ALGONQUIN RD.)	ALGONQUIN, CARY, CRYSTAL LAKE, LAKE IN THE HILLS	ALGONQUIN, NUNDA	35-55 MPH	31,100 (2013)
LOC.3	US 14 (IL 47 TO BUNKER HILL RD.)	WOODSTOCK	DORR, HARTLAND, SENECA	55 MPH	12,700 (2013)
LOC.4	IL 31 (IL 176 TO IL 120)	CRYSTAL LAKE, MCHENRY, PRAIRIE GROVE	MCHENRY, NUNDA	30-55 MPH	19,800 (2013)
LOC.5	US 12 (IL 31 TO NORTH STATE LINE)	RICHMOND	RICHMOND	30-45 MPH	13,700 (2013)
LOC.6	IL 47 (US 14 TO IL 173)	HEBRON, WOODSTOCK	DORR, GREENWOOD, HEBRON	30-55 MPH	12,400 (2013)
LOC.7	IL 173 (US 14 TO IL 47)	HARVARD, HEBRON	ALDEN, CHEMUNG, HEBRON	35-55 MPH	4,700 (2013)

	SUMMARY - McHENRY COUNTY ARTERIAL ROUTES	HMA 2" MILL & RESURFACE (SY)
LOC.1	US 20 (GARDEN PRAIRIE RD. TO HARMONY RD.)	1,390
LOC.2	IL 31 (CRYSTAL LAKE RD. TO ALGONQUIN RD.)	500
LOC.3	US 14 (IL 47 TO BUNKER HILL RD.)	4,595
LOC.4	IL 31 (IL 176 TO IL 120)	431
LOC.5	US 12 (IL 31 TO NORTH STATE LINE)	1,522
LOC.6	IL 47 (US 14 TO IL 173)	3,551
LOC.7	IL 173 (US 14 TO IL 47)	12,026
	McHENRY COUNTY ARTERIAL TOTAL =	24015 SY

FILE NAME =	USER NAME = Aumm	DESIGNED -	REVISED -
c:\pwork\pwork\mum\0382486\HMA-McHenry.dgn		DRAWN -	REVISED -
Default	PLOT SCALE = 100.0000' / in.	CHECKED -	REVISED -
	PLOT DATE = 4/4/2014	DATE -	REVISED -

**STATE OF ILLINOIS
DEPARTMENT OF TRANSPORTATION**

**SUMMARY OF INTERMITTENT RESURFACING SCHEDULE
VARIOUS LOCATIONS IN McHENRY COUNTY**

SCALE: SHEET OF SHEETS STA. TO STA.

F.A. RTE.	SECTION	COUNTY	TOTAL SHEETS	SHEET NO.
VAR.	2014-027RS	MCHENRY	33	6
			CONTRACT NO. 60Y13	
ILLINOIS FED. AID PROJECT				

ROUTE: IL 173 (IL 47 - US 14)		(Continued)					
CROSS STREET		DIRECTION	LANE	PAVEMENT	PAVEMENT	REPAIR	REPAIR
FROM	TO	(EB/WB)	NO.	PATCH	PATCH	AREA	AREA
		(NB/SB)	(1, 2, 3)	WIDTH	LENGTH	(SQ FT)	(SQ YD)
Harvard Hills Road		EB	1	36	10	360	40
		EB	1	12	8	96	11
		EB	1	12	3	36	4
		EB	1	12	30	360	40
		EB	1	12	3	36	4
		EB	1	12	3	36	4
		EB	1	12	3	36	4
		EB	1	12	3	36	4
		EB	1	12	40	480	53
		EB	1	12	60	720	80
		EB	1	12	20	240	27
		EB	1	12	10	120	13
		EB	1	12	80	960	107
		EB	1	12	3	36	4
		EB	1	12	3	36	4
		EB	1	12	3	36	4
		EB	1	12	3	36	4
		EB	1	12	3	36	4
		EB	1	12	3	36	4
		EB	1	12	100	1200	133
		EB	1	12	40	480	53
		EB	1	12	40	480	53
		EB	1	6	100	600	67
		EB	1	12	4	48	5
		EB	1	12	4	48	5
		EB	1	12	4	48	5
		EB	1	12	80	960	107
		EB	1	12	3	36	4
		EB	1	12	3	36	4
		EB	1	12	3	36	4
		EB	1	12	100	1200	133
		EB	1	12	200	2400	267
		EB	1	12	10	120	13
		EB	1	12	8	96	11
		EB	1	12	6	72	8
		EB	1	12	3	36	4
		EB	1	12	3	36	4
		EB	1	12	3	36	4
		EB	1	12	8	96	11
		EB	1	12	6	72	8
		EB	1	12	6	72	8
		EB	1	12	6	72	8
		EB	1	12	10	120	13
		EB	1	12	12	144	16
		EB	1	12	3	36	4
		EB	1	12	3	36	4
		EB	1	12	3	36	4
		EB	1	12	3	36	4
		EB	1	12	3	36	4
		EB	1	6	200	1200	133
		EB	1	12	4	48	5
		EB	1	12	4	48	5
		EB	1	12	40	480	53
		EB	1	12	4	48	5

ROUTE: IL 173 (IL 47 - US 14)		(Continued)					
CROSS STREET		DIRECTION	LANE	PAVEMENT	PAVEMENT	REPAIR	REPAIR
FROM	TO	(EB/WB)	NO.	PATCH	PATCH	AREA	AREA
		(NB/SB)	(1, 2, 3)	WIDTH	LENGTH	(SQ FT)	(SQ YD)
		EB	1	12	10	120	13
		EB	1	12	10	120	13
		EB	1	12	4	48	5
		EB	1	12	4	48	5
		EB	1	12	4	48	5
		EB	1	12	4	48	5
		EB	1	6	100	600	67
Altenburg Road	Altenburg Road	EB	1	12	10	120	13
		EB	1	12	4	48	5
		EB	1	12	40	480	53
		EB	1	12	3	36	4
		EB	1	3	100	300	33
		EB	1	3	12	36	4
		EB	1	12	3	36	4
		EB	1	12	3	36	4
		EB	1	12	3	36	4
		EB	1	12	4	48	5
		EB	1	12	4	48	5
		EB	1	12	4	48	5
		EB	1	12	3	36	4
		EB	1	12	3	36	4
		EB	1	12	4	48	5
		EB	1	12	4	48	5
		EB	1	12	3	36	4
		EB	1	12	3	36	4
		EB	1	12	3	36	4
		EB	1	3	40	120	13
		EB	1	12	4	48	5
		EB	1	12	4	48	5
		EB	1	12	4	48	5
		EB	1	3	200	600	67
		EB	1	12	4	48	5
		EB	1	12	4	48	5
		EB	1	12	4	48	5
		EB	1	12	4	48	5
		EB	1	12	4	48	5
		EB	1	12	3	36	4
		EB	1	12	3	36	4
		EB	1	12	3	36	4
		EB	1	12	3	36	4
		EB	1	12	3	36	4
		EB	1	12	3	36	4
		EB	1	12	4	48	5
		EB	1	12	4	48	5
		EB	1	12	4	48	5
		EB	1	12	4	48	5
		EB	1	12	40	480	53
		EB	1	12	3	36	4
		EB	1	12	3	36	4

CONTINUED ON NEXT SHEET

ROUTE: IL 173 (IL 47 - US 14)		(Continued)					
CROSS STREET		DIRECTION	LANE	PAVEMENT	PAVEMENT	REPAIR	REPAIR
FROM	TO	(EB/WB)	NO.	PATCH	PATCH	AREA	AREA
		(NB/SB)	(1, 2, 3)	WIDTH	LENGTH	(SQ FT)	(SQ YD)
		EB	1	12	3	36	4
		EB	1	12	3	36	4
		EB	1	12	100	1200	133
		EB	1	12	3	36	4
		EB	1	12	3	36	4
		EB	1	12	3	36	4
		EB	1	12	3	36	4
		EB	1	12	3	36	4
		EB	1	12	4	48	5
		EB	1	12	6	72	8
		EB	1	12	3	36	4
		EB	1	12	3	36	4
	Reese Road	EB	1	12	3	36	4
Reese Road		EB	1	12	3	36	4
		EB	1	12	3	36	4
		EB	1	12	3	36	4
		EB	1	12	4	48	5
		EB	1	12	8	96	11
		EB	1	12	3	36	4
		EB	1	12	3	36	4
		EB	1	12	3	36	4
		EB	1	4	30	120	13
		EB	1	12	3	36	4
		EB	1	12	3	36	4
		EB	1	12	3	36	4
		EB	1	12	3	36	4
		EB	1	12	3	36	4
		EB	1	12	3	36	4
		EB	1	12	3	36	4
		EB	1	12	50	600	67
		EB	1	12	4	48	5
		EB	1	6	100	600	67
		EB	1	6	50	300	33
		EB	1	12	5	60	7
		EB	1	12	6	72	8
		EB	1	12	4	48	5
		EB	1	12	4	48	5
		EB	1	12	3	36	4
		EB	1	12	4	48	5
		EB	1	6	40	240	27
		EB	1	12	4	48	5
		EB	1	6	30	180	20
		EB	1	12	3	36	4
		EB	1	12	3	36	4
		EB	1	12	3	36	4
		EB	1	12	3	36	4
		EB	1	12	3	36	4
		EB	1	12	3	36	4
		EB	1	12	3	36	4
		EB	1	12	3	36	4
		EB	1	12	3	36	4
		EB	1	12	3	36	4
		EB	1	12	20	240	27
		EB	1	12	3	36	4
	Shields Road	EB	1	12	3	36	4

ROUTE: IL 173 (IL 47 - US 14)		(Continued)					
CROSS STREET		DIRECTION	LANE	PAVEMENT	PAVEMENT	REPAIR	REPAIR
FROM	TO	(EB/WB)	NO.	PATCH	PATCH	AREA	AREA
		(NB/SB)	(1, 2, 3)	WIDTH	LENGTH	(SQ FT)	(SQ YD)
Shields Road		EB	1	12	3	36	4
		EB	1	12	3	36	4
		EB	1	12	3	36	4
		EB	1	12	3	36	4
		EB	1	12	3	36	4
		EB	1	12	3	36	4
		EB	1	12	3	36	4
		EB	1	12	3	36	4
		EB	1	12	8	96	11
		EB	1	12	4	48	5
		EB	1	12	4	48	5
		EB	1	6	40	240	27
		EB	1	12	3	36	4
		EB	1	12	4	48	5
		EB	1	12	4	48	5
		EB	1	12	6	72	8
		EB	1	6	30	180	20
		EB	1	12	30	360	40
	O'Brien Road	EB	1	6	100	600	67
O'Brien Road		EB	1	12	3	36	4
		EB	1	12	3	36	4
		EB	1	12	3	36	4
		EB	1	12	3	36	4
		EB	1	12	3	36	4
		EB	1	12	3	36	4
		EB	1	12	3	36	4
		EB	1	12	6	72	8
		EB	1	12	4	48	5
	Nolan Street	EB	1	12	3	36	4
Nolan Street		EB	1	12	3	36	4
		EB	1	12	3	36	4
		EB	1	12	6	72	8
		EB	1	12	4	48	5
		EB	1	12	4	48	5
		EB	1	3	100	300	33
		EB	1	3	12	36	4
		EB	1	3	12	36	4
		EB	1	12	3	36	4
		EB	1	12	10	120	13
		EB	1	12	4	48	5
		EB	1	12	4	48	5
		EB	1	6	150	900	100
		EB	1	12	3	36	4
		EB	1	12	4	48	5
		EB	1	12	3	36	4
		EB	1	12	4	48	5
		EB	1	12	3	36	4
	Oak Grove Road	EB	1	12	3	36	4
Oak Grove Road		EB	1	12	3	36	4
		EB	1	12	3	36	4
		EB	1	12	3	36	4
		EB	1	6	100	600	67
		EB	1	12	15	180	20
		EB	1	8	140	1120	124
		EB	1	12	4	48	5
		EB	1	12	4	48	5

CONTINUED ON NEXT SHEET

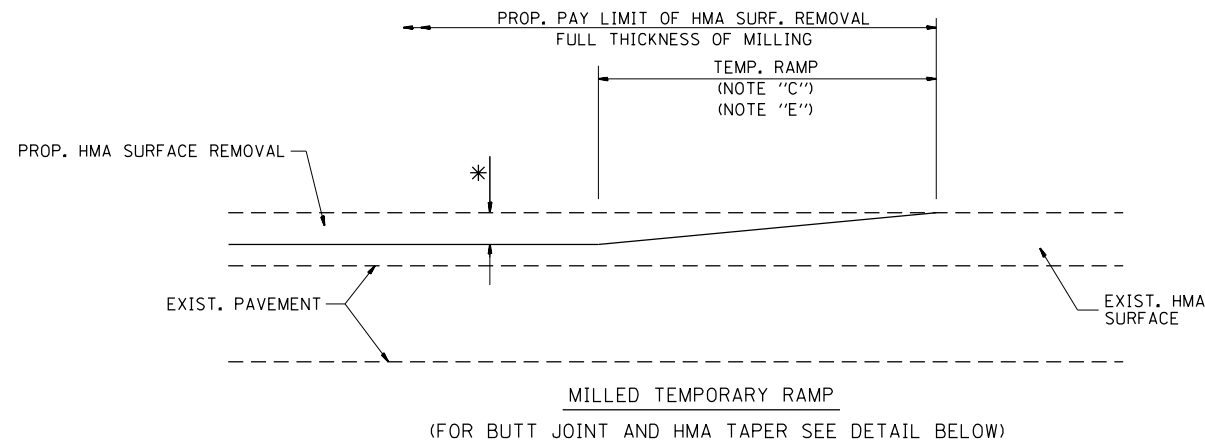

OPTION 1

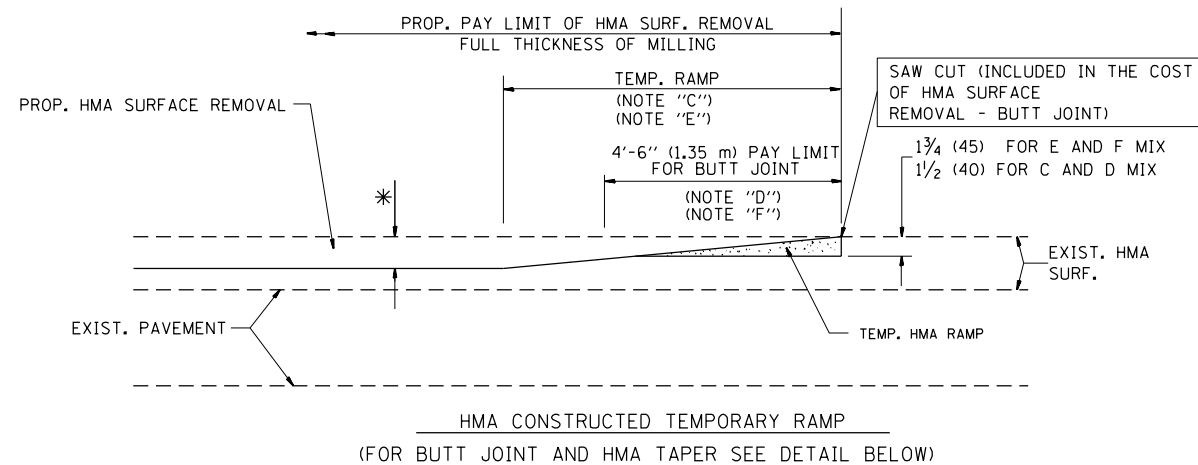

OPTION 2

TYPICAL TEMPORARY RAMP

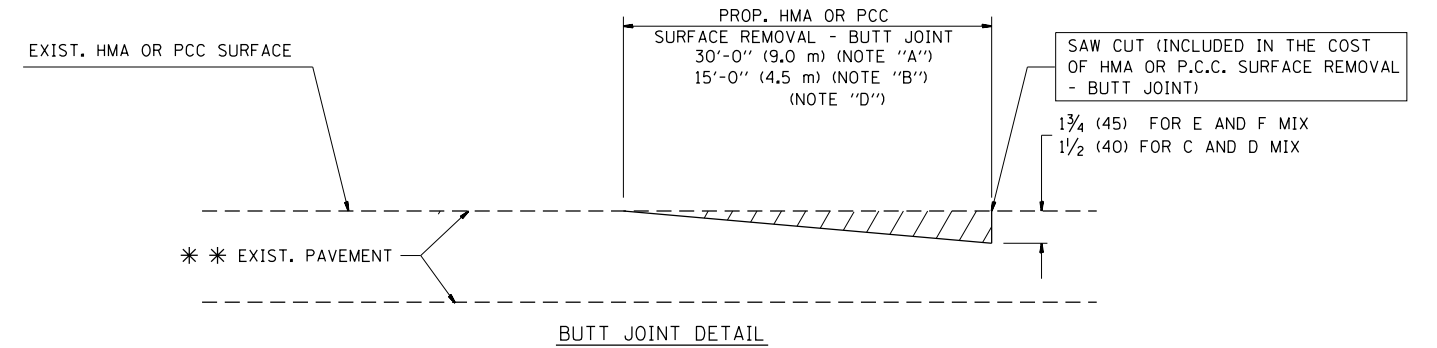

BUTT JOINT DETAIL

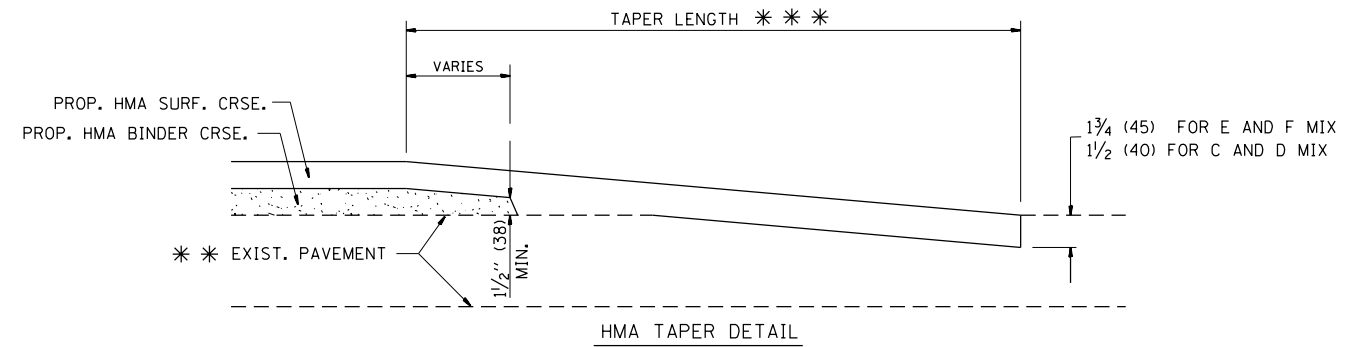

HMA TAPER DETAIL

TYPICAL BUTT JOINT AND HMA TAPER FOR RESURFACING ONLY

*** PC CONCRETE, HMA OR HMA RESURFACED PAVEMENT.

NOTES

- A: MAINLINE ROADWAYS AND MAJOR SIDE ROADS.
 - B: MINOR SIDE ROADS.
 - C: THE TEMP. RAMP SHALL BE CONSTRUCTED IMMEDIATELY UPON REMOVAL OF THE EXISTING HMA SURFACE.
 - D: THE BUTT JOINT SHALL BE CONSTRUCTED IMMEDIATELY PRIOR TO PLACING THE PROPOSED HMA COURSES.
 - E: TAPER THE TEMP. RAMP AT A RATE OF 3'-0" (900 mm) PER 1 INCH (25 mm) OF MILLING THICKNESS.
 - F: INSTALLATION AND REMOVAL OF THE 4'-6" (1.35 m) TEMP. RAMP IS INCLUDED IN COST OF HMA SURFACE REMOVAL - BUTT JOINT
 - G: SEE ARTICLE 406.08 AND 406.14 OF THE STANDARD SPECIFICATIONS FOR "HMA AND/OR PCC SURFACE REMOVAL, BUTT JOINT".
- * SEE TYPICAL SECTIONS FOR MILLING THICKNESS.
- *** 20'-0" (6.1 m) PER 1 (25) RESURFACING (NOTE "A")
10'-0" (3.0 m) PER 1 (25) RESURFACING (NOTE "B")

BASIS OF PAYMENT:

THE BUTT JOINT WILL BE PAID FOR AT THE CONTRACT UNIT PRICE PER SQUARE YARD (SQUARE METER) FOR "HOT-MIX ASPHALT SURFACE REMOVAL - BUTT JOINT" OR FOR "PORTLAND CEMENT CONCRETE SURFACE REMOVAL - BUTT JOINT".

ALL DIMENSIONS ARE IN INCHES (MILLIMETERS) UNLESS OTHERWISE SHOWN.

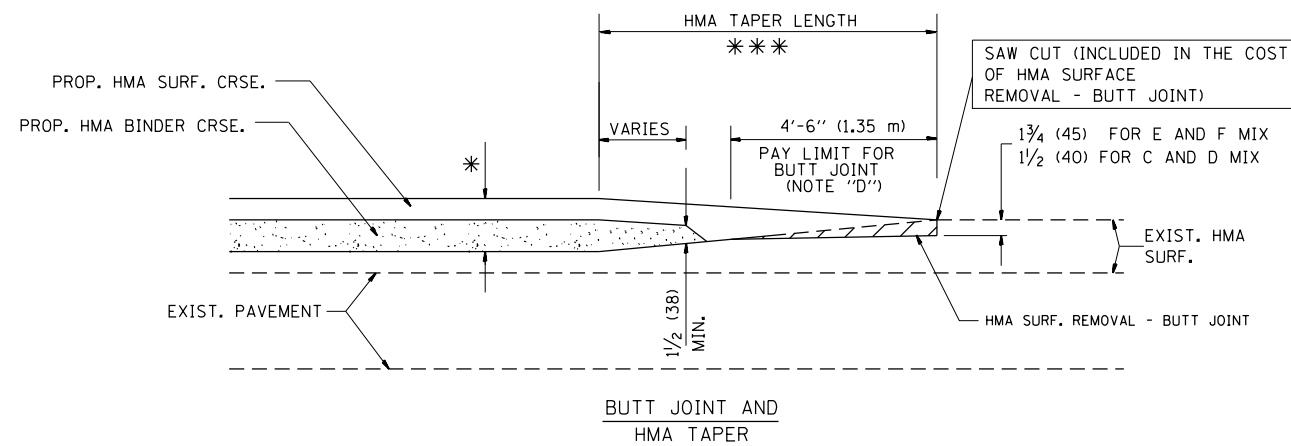

TYPICAL BUTT JOINT AND HMA TAPER FOR MILLING AND RESURFACING

FILE NAME =	USER NAME = Aumm	DESIGNED - M. DE YONG	REVISED - R. SHAH 10-25-94
et:\pw\work\p1dot\aummm\d0382486\60Y13-D	stStd.dgn	DRAWN -	REVISED - A. ABBAS 03-21-97
	PLOT SCALE = 100.0000' / 1in.	CHECKED -	REVISED - M. GOMEZ 04-06-01
	PLOT DATE = 4/4/2014	DATE - 06-13-90	REVISED - R. BORO 01-01-07

**STATE OF ILLINOIS
DEPARTMENT OF TRANSPORTATION**

BUTT JOINT AND HMA TAPER DETAILS	
SCALE: NONE	SHEET NO. 1 OF 1 SHEETS
STA.	TO STA.

F.A. RTE.	SECTION	COUNTY	TOTAL SHEETS	SHEET NO.
VAR.	2014-027RS	MCHENRY	33	25
BD400-05 BD32		CONTRACT NO. 60Y13		
FED. ROAD DIST. NO. 1 ILLINOIS FED. AID PROJECT				

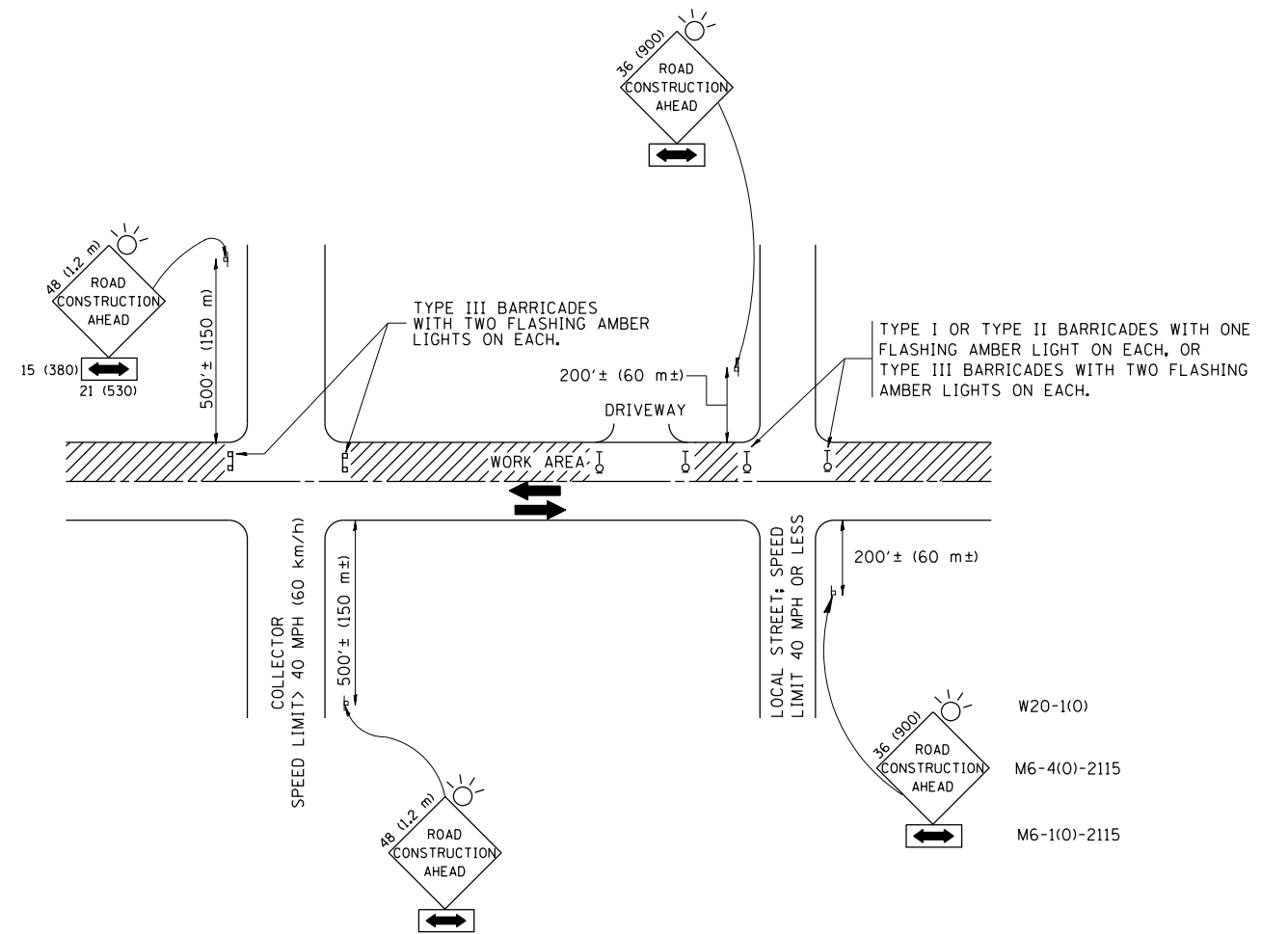

TRAFFIC CONTROL AND PROTECTION FOR SIDE ROADS, INTERSECTIONS, AND DRIVEWAYS

NOTES:

A. FOR NO LANE RESTRICTION ON THE SIDE ROAD OR DRIVEWAYS

1. SIDE ROAD WITH A SPEED LIMIT OF 40 MPH (60 km/h) OR LESS AS SHOWN ON THE DRAWING AND AS DIRECTED BY THE ENGINEER:

a) ONE ROAD CONSTRUCTION AHEAD SIGN 36 x 36 (900x900) WITH A FLASHER AND FLAG MOUNTED ON IT APPROXIMATELY 200' (60 m) IN ADVANCE OF THE MAIN ROUTE.

b) THE CLOSED PORTION OF THE MAIN ROUTE SHALL BE PROTECTED BY BLOCKING WITH TYPE I, TYPE II OR TYPE III BARRICADES, 1/3 OF THE CROSS SECTION OF THE CLOSED PORTION.

2. SIDE ROAD WITH A SPEED LIMIT GREATER THAN 40 MPH (60 km/h) AS SHOWN ON THE DRAWING AND AS DIRECTED BY THE ENGINEER:

a) ONE ROAD CONSTRUCTION AHEAD SIGN 48 x 48 (1.2 m x 1.2 m) WITH A FLASHER MOUNTED ON IT APPROXIMATELY 500' (150 m) IN ADVANCE OF THE MAIN ROUTE.

b) THE CLOSED PORTION OF THE MAIN ROUTE SHALL BE PROTECTED BY BLOCKING WITH TYPE III BARRICADES, 1/2 OF THE CROSS SECTION OF THE CLOSED PORTION.

3. WHEN THE SIDE ROAD LIES BETWEEN THE BEGINNING OF THE MAINLINE SIGNING AND THE WORK ZONE, A SINGLE HEADED ARROW (M6-1) SHALL BE USED IN LIEU OF THE DOUBLE HEADED ARROW (M6-4).

B. FOR A LANE CLOSURE ON A SIDE ROAD OR DRIVEWAY:

USE APPLICABLE PORTIONS OF THE TYPICAL APPLICATION OF TRAFFIC CONTROL DEVICES (STD. 701501, STD. 701606 OR THE APPROPRIATE STANDARD). THE SPACING OF SIGNS AND BARRICADES SHALL BE ADJUSTED FOR FIELD CONDITIONS AS DIRECTED BY THE ENGINEER. THE DIRECTIONAL ARROW SHALL BE COVERED OR REMOVED WHEN NO LONGER CONSISTENT WITH THE SIDE ROAD LANE CLOSURE.

C. ADVANCE WARNING SIGNS ARE TO BE OMITTED ON DRIVEWAY UNLESS OTHERWISE NOTED.

D. THE TRAFFIC CONTROL AND PROTECTION FOR SIDE ROADS, INTERSECTIONS, AND DRIVEWAYS SHALL BE INCIDENTAL TO THE COST OF SPECIFIED TRAFFIC CONTROL STANDARDS OR ITEMS.

All dimensions are in millimeters (inches) unless otherwise shown.

FILE NAME =	USER NAME = Aumm	DESIGNED - LHA	REVISED - J. OBERLE 10-18-95
et:\pwork\pwork\pwork\pwork\d0382486\60Y13-D	stStd.dgn	DRAWN -	REVISED - A. HOUSEH 03-06-96
	PLOT SCALE = 100.0000' / in.	CHECKED -	REVISED - A. HOUSEH 10-15-96
	PLOT DATE = 4/4/2014	DATE - 06-89	REVISED - T. RAMMACH 01-06-00

STATE OF ILLINOIS
DEPARTMENT OF TRANSPORTATION

TRAFFIC CONTROL AND PROTECTION FOR
SIDE ROADS, INTERSECTIONS, AND DRIVEWAYS

SCALE: NONE SHEET NO. 1 OF 1 SHEETS STA. TO STA.

F.A. RTE.	SECTION	COUNTY	TOTAL SHEETS	SHEET NO.
VAR.	2014-027RS	MCHENRY	33	26
TC-10			CONTRACT NO. 60Y13	
FED. ROAD DIST. NO. 1 ILLINOIS FED. AID PROJECT				

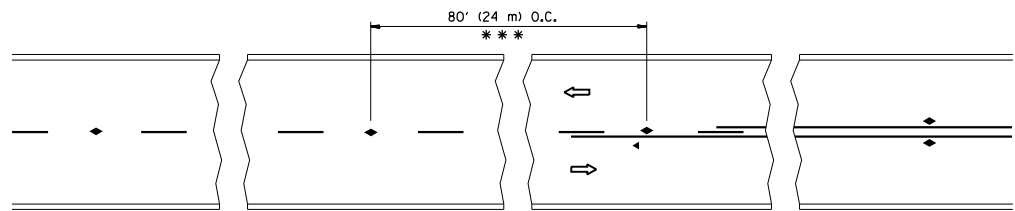

*** REDUCE TO 40' (12 m) O.C. ON CURVES WITH POSTED OR ADVISORY SPEED 45 M.P.H. (70 km/h) OR LESS.

TWO-LANE/TWO-WAY

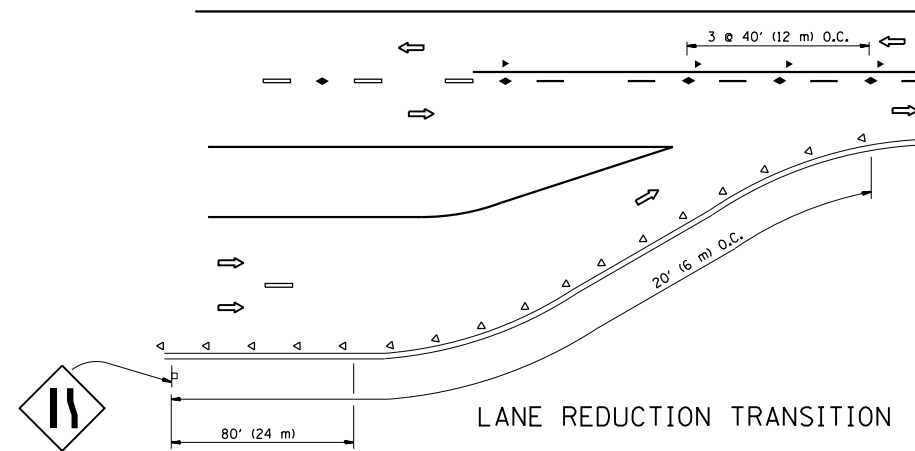

LANE REDUCTION TRANSITION

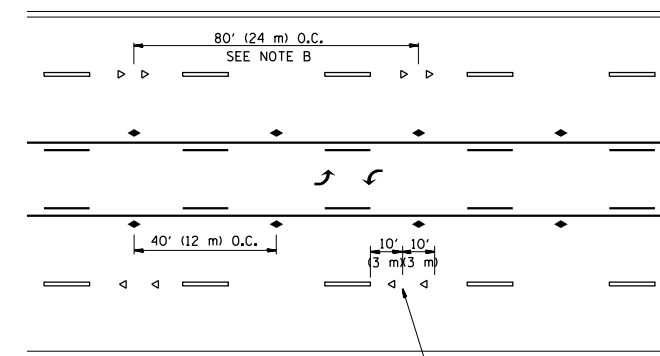

TWO-WAY LEFT TURN

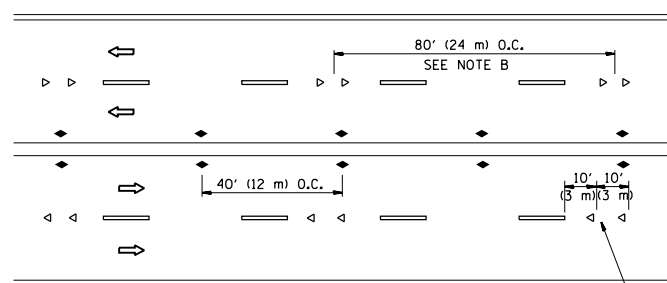

MULTI-LANE/UNDIVIDED

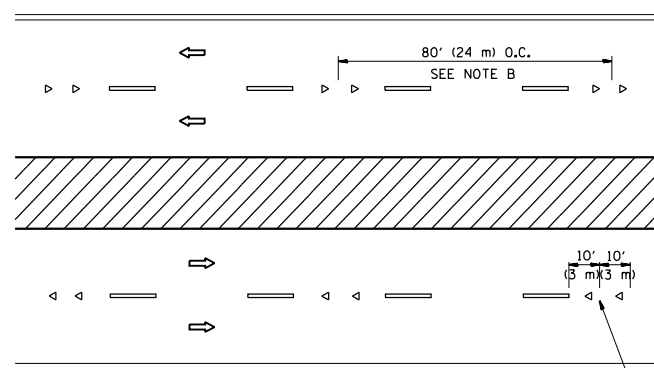

MULTI-LANE/DIVIDED

GENERAL NOTES

1. MARKERS USED WITH DASHED LINES SHALL BE CENTERED IN THE GAP BETWEEN SEGMENTS.
2. MARKERS USED ADJACENT TO SOLID LINES SHALL BE OFFSET 2 TO 3 (50 TO 75) TOWARD TRAFFIC AS SHOWN.
3. MARKERS THROUGH TANGENTS LESS THAN 500' (150 m) IN LENGTH BETWEEN CURVES SHALL BE INSTALLED AT THE LESSER OF THE TWO CURVE SPACINGS.

SYMBOLS

- YELLOW STRIPE
- WHITE STRIPE
- ◀ ONE-WAY AMBER MARKER
- ◁ ONE-WAY CRYSTAL MARKER (W/O)
- ◆ TWO-WAY AMBER MARKER

LANE MARKER NOTES

- A. USE DOUBLE LANE LINE MARKERS SPACED AS SHOWN.
- B. REDUCE TO 40' (12 m) O.C. ON CURVES WHERE ADVISORY SPEEDS ARE 10 M.P.H (20 km/h) LOWER THAN POSTED SPEEDS.

DESIGN NOTES

1. DOUBLE LANE LINE MARKERS SHALL BE USED UNLESS SPECIFIED OTHERWISE.
2. EXCEPT AS SHOWN ON THE LANE REDUCTION TRANSITION AND FREEWAY EXIT RAMP DETAIL, MARKERS ARE NOT TO BE SPECIFIED ON RIGHT EDGE LINES.
3. THE EXACT MARKER LIMITS, SPACING, AND COLOR SHALL BE INCLUDED IN THE PLANS WHEN STANDARD SPECIFICATIONS ARE NOT BEING USED.
4. MARKERS SHOULD NOT BE USED ALONGSIDE CURBS EXCEPT FOR EXTREMELY SHORT SECTIONS OF CURBS WHERE NOT MORE THAN TWO MARKERS WOULD BE INVOLVED.

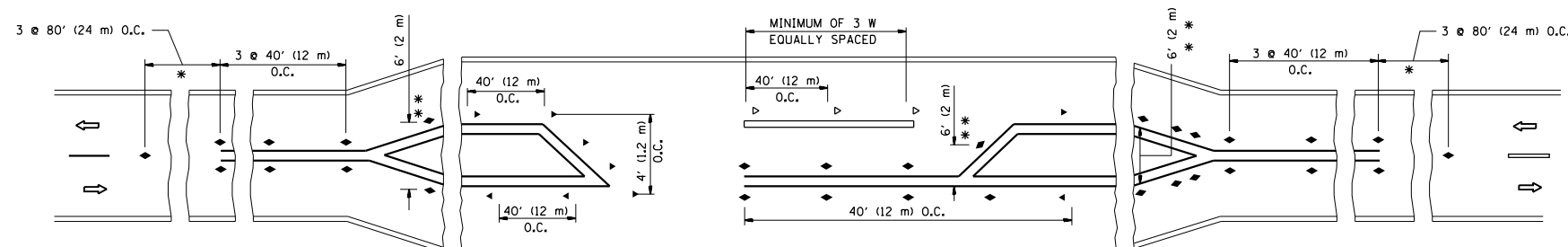

* SEE TWO-LANE/TWO-WAY WHERE MARKERS CONTINUE
 ** WHERE THE MEDIAN WIDTH IS 6' (2 m) OR LESS USE TWO-WAY MARKERS.

LEFT TURN

All dimensions are in inches (millimeters) unless otherwise shown.

FILE NAME =	USER NAME = Aumm	DESIGNED -	REVISED - T. RAMMACHER 09-19-94
et:\pw\work\p1\dot\Aumm\d0382486\60Y13-D	stStd.dgn	DRAWN -	REVISED - T. RAMMACHER 03-12-99
	PLOT SCALE = 100.0000' / 1"	CHECKED -	REVISED - T. RAMMACHER 01-06-00
	PLOT DATE = 4/4/2014	DATE -	REVISED - C. JUCIUS 09-09-09

STATE OF ILLINOIS
 DEPARTMENT OF TRANSPORTATION

TYPICAL APPLICATIONS			
RAISED REFLECTIVE PAVEMENT MARKERS (SNOW-PLOW RESISTANT)			
SCALE: NONE	SHEET NO. 1 OF 1 SHEETS	STA.	TO STA.

F.A. RTE.	SECTION	COUNTY	TOTAL SHEETS	SHEET NO.
VAR.	2014-027RS	MCHENRY	33	27
TC-11		CONTRACT NO. 60Y13		
FED. ROAD DIST. NO. 1 ILLINOIS FED. AID PROJECT				

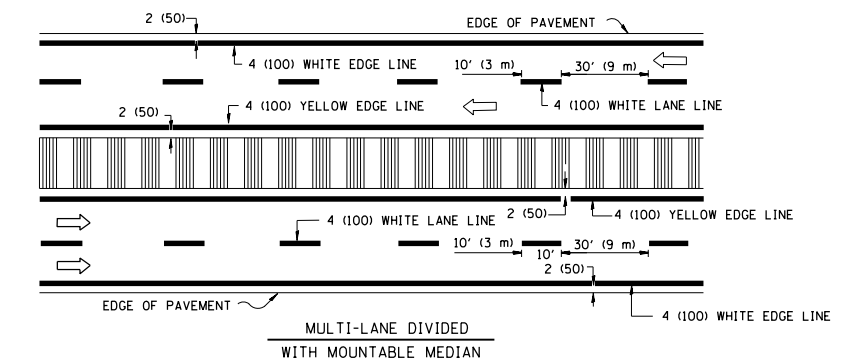
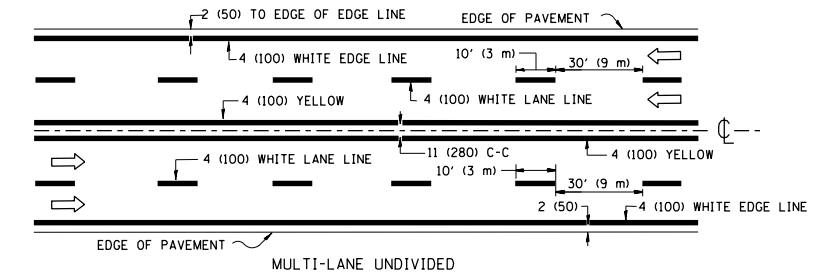
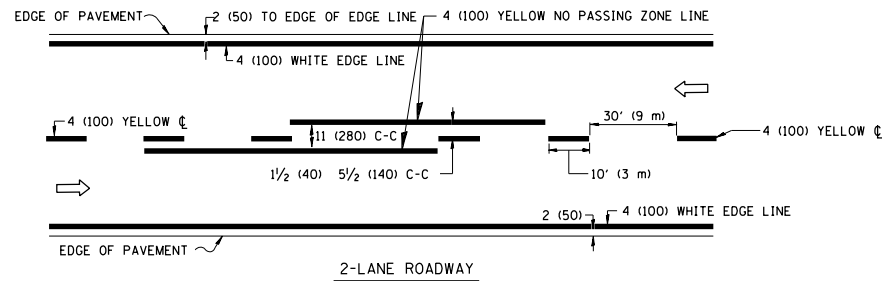

NOTE: MEDIANS WITH BARRIER CURB DO NOT REQUIRE AN EDGE LINE

TYPICAL LANE AND EDGE LINE MARKING

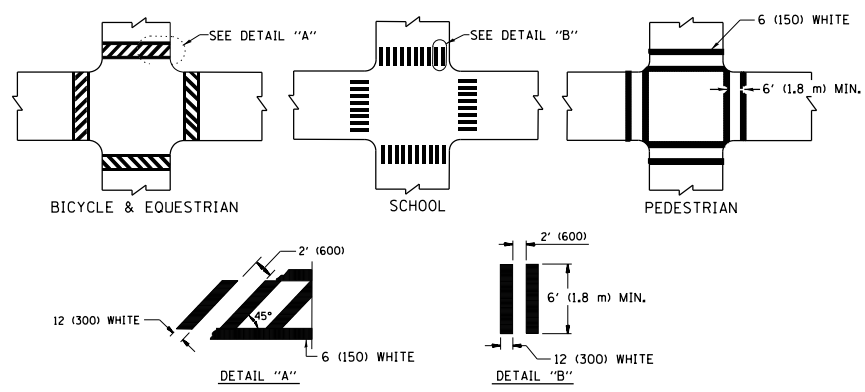

TYPICAL CROSSWALK MARKING

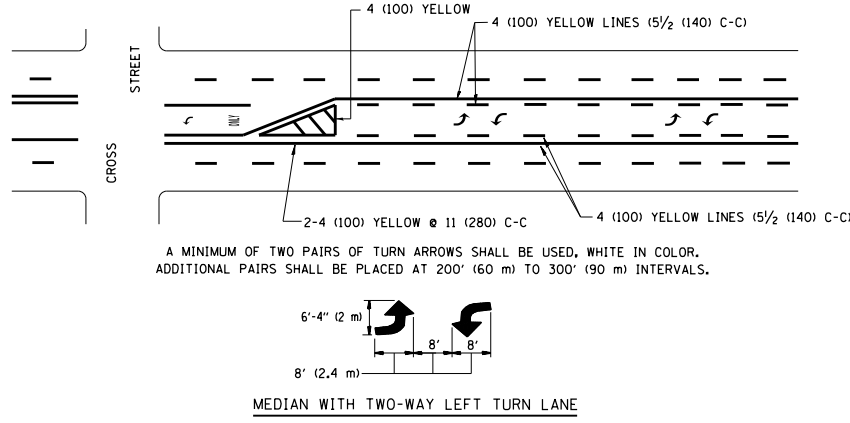
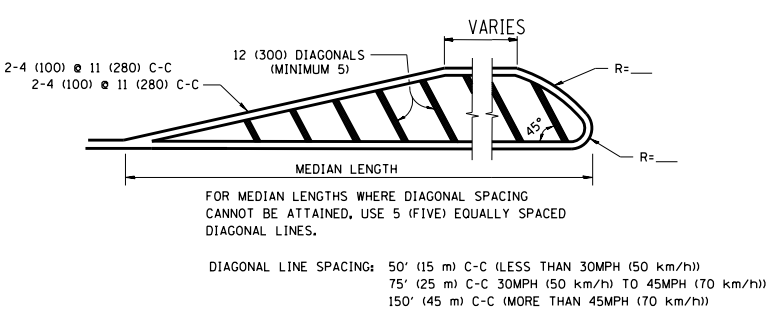
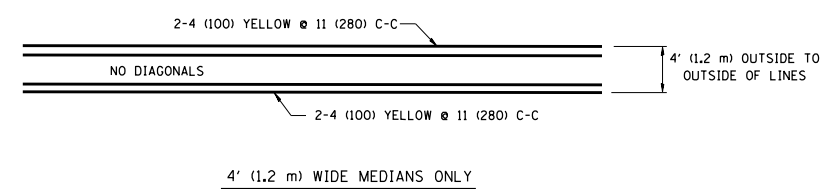

TYPICAL PAINTED MEDIAN MARKING

A MINIMUM OF TWO PAIRS OF TURN ARROWS SHALL BE USED, WHITE IN COLOR. ADDITIONAL PAIRS SHALL BE PLACED AT 200' (60 m) TO 300' (90 m) INTERVALS.

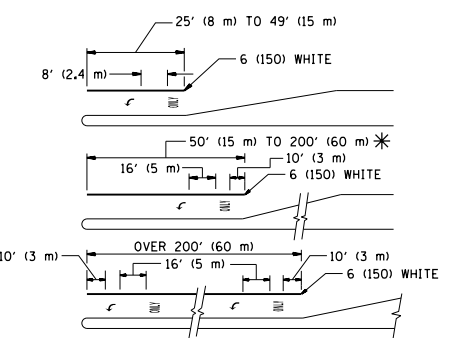

FULL SIZE LETTERS 8' (2.4 m) AND ARROWS SHALL BE USED.
 * TURN LANES IN EXCESS OF 400' (120 m) IN LENGTH MAY HAVE AN ADDITIONAL SET OF ARROW - "ONLY" INSTALLED MIDWAY BETWEEN THE OTHER TWO SETS OF ARROW - "ONLY".

TYPICAL LEFT (OR RIGHT) TURN LANE

TYPICAL TURN LANE MARKING

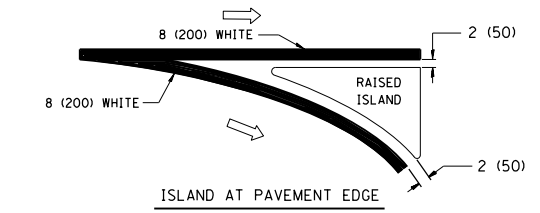
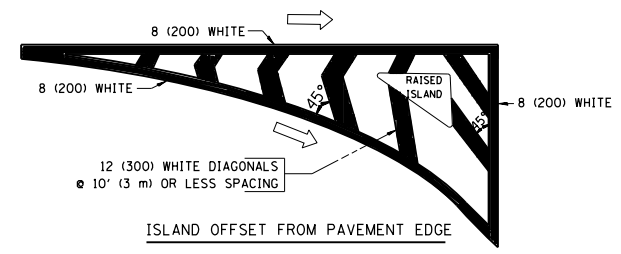

TYPICAL ISLAND MARKING

TYPE OF MARKING	WIDTH OF LINE	PATTERN	COLOR	SPACING / REMARKS
CENTERLINE ON 2 LANE PAVEMENT	4 (100)	SKIP-DASH	YELLOW	10' (3 m) LINE WITH 30' (9 m) SPACE
CENTERLINE ON MULTI-LANE UNDIVIDED PAVEMENT	2 @ 4 (100)	SOLID	YELLOW	11 (280) C-C
NO PASSING ZONE LINES: FOR ONE DIRECTION	4 (100)	SOLID	YELLOW	5/2 (140) C-C FROM SKIP-DASH CENTERLINE
NO PASSING ZONE LINES: FOR BOTH DIRECTIONS	2 @ 4 (100)	SOLID	YELLOW	11 (280) C-C OMIT SKIP-DASH CENTERLINE BETWEEN
LANE LINES	4 (100) 5 (125) ON FREEWAYS	SKIP-DASH SKIP-DASH	WHITE WHITE	10' (3 m) LINE WITH 30' (9 m) SPACE
DOTTED LINES (EXTENSIONS OF CENTER, LANE OR TURN LANE MARKINGS)	SAME AS LINE BEING EXTENDED	SKIP-DASH	SAME AS LINE BEING EXTENDED	2' (600) LINE WITH 6' (1.8 m) SPACE
EDGE LINES	4 (100)	SOLID	YELLOW-LEFT WHITE-RIGHT	OUTLINE MOUNTABLE MEDIANS IN YELLOW; EDGE LINES ARE NOT USED NEXT TO BARRIER CURB
TURN LANE MARKINGS	6 (150) LINE; FULL SIZE LETTERS & SYMBOLS (8' (2.4m))	SOLID	WHITE	SEE TYPICAL TURN LANE MARKING DETAIL
TWO WAY LEFT TURN MARKING	2 @ 4 (100) EACH DIRECTION 8' (2.4m) LEFT ARROW	SKIP-DASH AND SOLID IN PAIRS	YELLOW WHITE	10' (3 m) LINE WITH 30' (9 m) SPACE FOR SKIP-DASH; 5/2 (140) C-C BETWEEN SOLID LINE AND SKIP-DASH LINE. SEE TYPICAL TWO-WAY LEFT TURN MARKING DETAIL
CROSSWALK LINES (PEDESTRIAN) A. DIAGONALS (BIKE & EQUESTRIAN) B. LONGITUDINAL BARS (SCHOOL)	2 @ 6 (150) 12 (300) @ 45° 12 (300) @ 90°	SOLID SOLID SOLID	WHITE WHITE WHITE	NOT LESS THAN 6' (1.8 m) APART 2' (600) APART 2' (600) APART SEE TYPICAL CROSSWALK MARKING DETAILS.
STOP LINES	24 (600)	SOLID	WHITE	PLACE 4' (1.2 m) IN ADVANCE OF AND PARALLEL TO CROSSWALK, IF PRESENT. OTHERWISE, PLACE AT DESIRED STOPPING POINT, PARALLEL TO CROSSROAD CENTERLINE, WHERE POSSIBLE
PAINTED MEDIANS	2 @ 4 (100) WITH 12 (300) DIAGONALS @ 45° NO DIAGONALS USED FOR 4' (1.2 m) WIDE MEDIANS	SOLID	YELLOW; TWO WAY TRAFFIC WHITE; ONE WAY TRAFFIC	11 (280) C-C FOR THE DOUBLE LINE. SEE TYPICAL PAINTED MEDIAN MARKING.
GORE MARKING AND CHANNELIZING LINES	8 (200) WITH 12 (300) DIAGONALS @ 45°	SOLID	WHITE	DIAGONALS: 15' (4.5 m) C-C (LESS THAN 30MPH (50 km/h)) 20' (6 m) C-C 30MPH (50 km/h) TO 45MPH (70 km/h) 30' (9 m) C-C (OVER 45MPH (70 km/h))
RAILROAD CROSSING	24 (600) TRANSVERSE LINES; "RR" 15' (4.5 m) MIN. LETTERS; 16 (400) LINE FOR "X"	SOLID	WHITE	SEE STATE STANDARD 780001 AREA OF: "R": 3.6 SQ. FT. (0.33 m ²) EACH "X": 54.0 SQ. FT. (5.0 m ²) EACH
SHOULDER DIAGONALS	12 (300) @ 45°	SOLID	WHITE - RIGHT YELLOW - LEFT	50' (15 m) C-C (LESS THAN 30MPH (50 km/h)) 75' (25 m) C-C (30 MPH (50 km/h) TO 45MPH (70 km/h)) 150' (45 m) C-C (OVER 45MPH (70 km/h))

FOR FURTHER DETAILS ON PAVEMENT MARKING REFER TO STANDARD SPECIFICATIONS FOR ROAD AND BRIDGE CONSTRUCTION AND STATE STANDARD 780001.

All dimensions are in inches (millimeters) unless otherwise shown.

FILE NAME =	USER NAME = Aumm	DESIGNED - EVERS	REVISED - T. RAMMACHER 10-27-94
et:\pw_work\p1dot\au\m\d0382486\60Y13-D	stStd.dgn	DRAWN -	REVISED - C. JUCIUS 09-09-09
	PLOT SCALE = 100.0000' / 1"	CHECKED -	REVISED -
	PLOT DATE = 4/4/2014	DATE - 03-19-90	REVISED -

**STATE OF ILLINOIS
DEPARTMENT OF TRANSPORTATION**

DISTRICT ONE			
TYPICAL PAVEMENT MARKINGS			
SCALE: NONE	SHEET NO. 1 OF 1 SHEETS	STA.	TO STA.

F.A. RTE.	SECTION	COUNTY	TOTAL SHEETS	SHEET NO.
VAR.	2014-02TR5	MCHENRY	33	28
TC-13		CONTRACT NO. 60Y13		
FED. ROAD DIST. NO. 1 ILLINOIS FED. AID PROJECT				

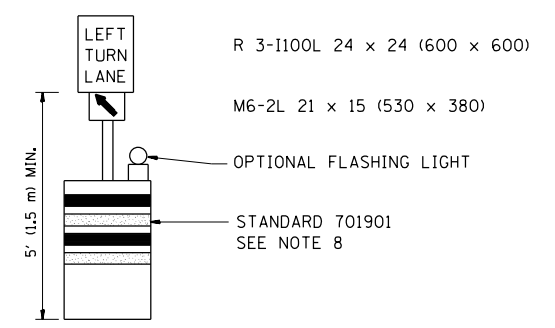
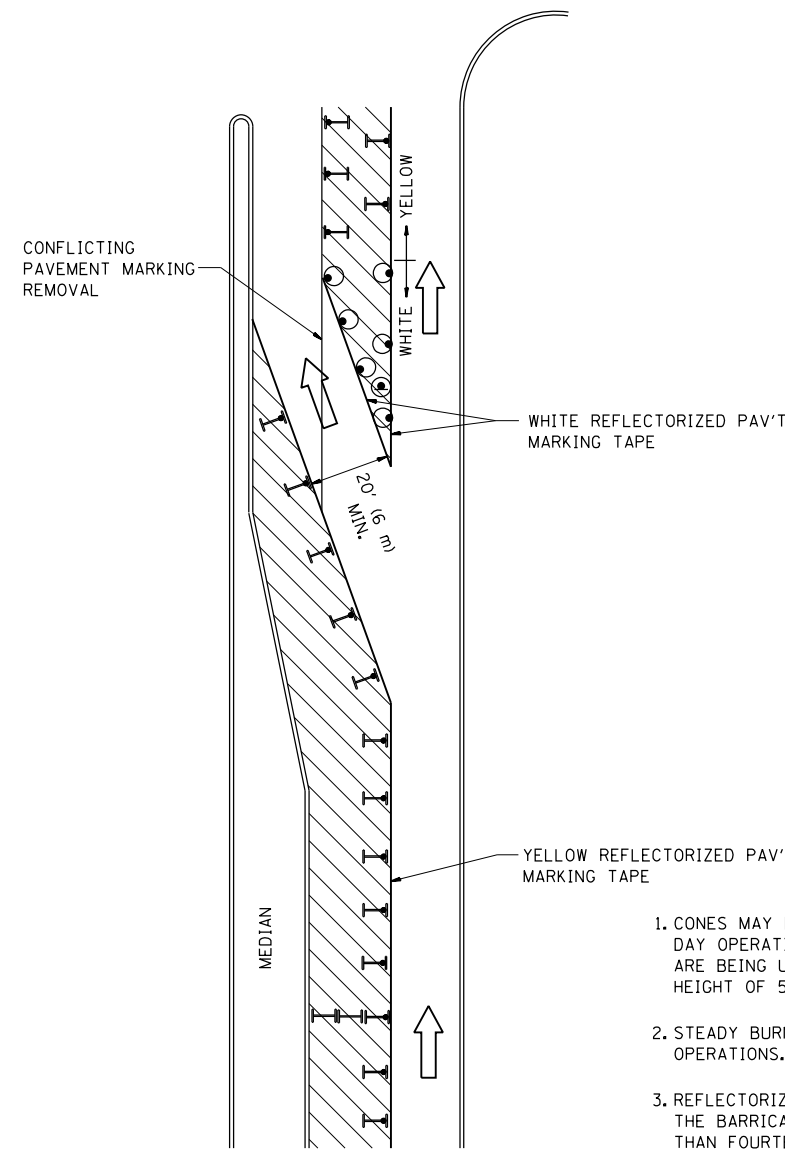





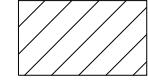

GENERAL NOTES

1. CONES MAY BE SUBSTITUTED FOR BARRICADES OR DRUMS AT HALF THE SPACING DURING DAY OPERATIONS. CONES SHALL BE A MINIMUM OF 28 (710) IN HEIGHT. WHEN CONES ARE BEING USED, THE "LEFT TURN LANE" SIGN MAY BE SKID MOUNTED AT A MINIMUM HEIGHT OF 5' (1.5 m).
2. STEADY BURNING LIGHTS WILL NOT BE REQUIRED ON BARRICADES OR DRUMS FOR DAY OPERATIONS. ALL LIGHTS SHALL BE MONODIRECTIONAL.
3. REFLECTORIZED TEMPORARY PAVEMENT MARKING TAPE SHALL BE PLACED THROUGHOUT THE BARRICADED AREA OF EACH TURN BAY WHERE THE CLOSURE TIME IS GREATER THAN FOURTEEN DAYS.
4. THIS APPLICATION ALSO APPLIES WHEN WORK IS BEING PERFORMED IN THE RIGHT LANE(S) AND THE RIGHT TURN BAY IS TO REMAIN OPEN. UNDER THIS CONDITION, "RIGHT TURN LANE" R3-100 24 x 24 (600 x 600) AND M6-2R 21 x 15 (530 x 380) SHALL BE USED.
5. THESE CONTROLS SHALL SUPPLEMENT MAINLINE TRAFFIC CONTROL FOR LANE CLOSURES.
6. LONGITUDINAL DIMENSIONS MAY BE ADJUSTED TO FIT FIELD CONDITIONS.
7. FORM OPER 725 IS REQUIRED.
8. IF A DRUM OR TYPE II BARRICADE WITH AN ATTACHED SIGN PANEL WHICH MEETS NCHRP 350 REQUIREMENTS IS NOT AVAILABLE, THE SIGNS SHALL BE MOUNTED, ABOVE THE BARRICADES, ON SEPARATE SIGNS SUPPORTS THAT MEET NCHRP 350 PREQUIREMENTS.
9. TRAFFIC CONTROL AND PROTECTION AT TURN BAYS (TO REMAIN OPEN TO TRAFFIC) SHALL BE INCLUDED IN THE COST SPECIFIED TRAFFIC CONTROL STANDARDS OR ITEMS.

All dimensions are in inches (millimeters) unless otherwise shown.

LEGEND

-  WORK AREA
-  LANE OPEN TO TRAFFIC
-  TYPE I OR II BARRICADE WITH STEADY BURN LIGHT
-  DRUM WITH STEADY BURN LIGHT
-  DRUM WITH SIGN (WITH OPTIONAL FLASHING LIGHT) SEE DETAIL
-  TYPE I OR II CHECK BARRICADE WITH FLASHING LIGHT

FILE NAME =	USER NAME = Aumm	REVISED -T, RAMMACHER 09-08-94	REVISED - R, BORO 09-14-09
et:\pw\work\p1dot\Aumm\d0382486\60Y13-D	stStd.dgn	REVISED - A. HOUSEH 11-07-95	REVISED -
	PLOT SCALE = 100.0000' / 1in.	REVISED - A. HOUSEH 10-12-96	REVISED -
	PLOT DATE = 4/4/2014	REVISED -T, RAMMACHER 01-06-00	REVISED -

**STATE OF ILLINOIS
DEPARTMENT OF TRANSPORTATION**

TRAFFIC CONTROL AND PROTECTION AT TURN BAYS (TO REMAIN OPEN TO TRAFFIC)			
SCALE: NONE	SHEET NO. 1 OF 1 SHEETS	STA.	TO STA.

F.A. RTE.	SECTION	COUNTY	TOTAL SHEETS	SHEET NO.
VAR.	2014-027RS	MCHENRY	33	29
TC-14		CONTRACT NO. 60Y13		
FED. ROAD DIST. NO. 1 ILLINOIS FED. AID PROJECT				

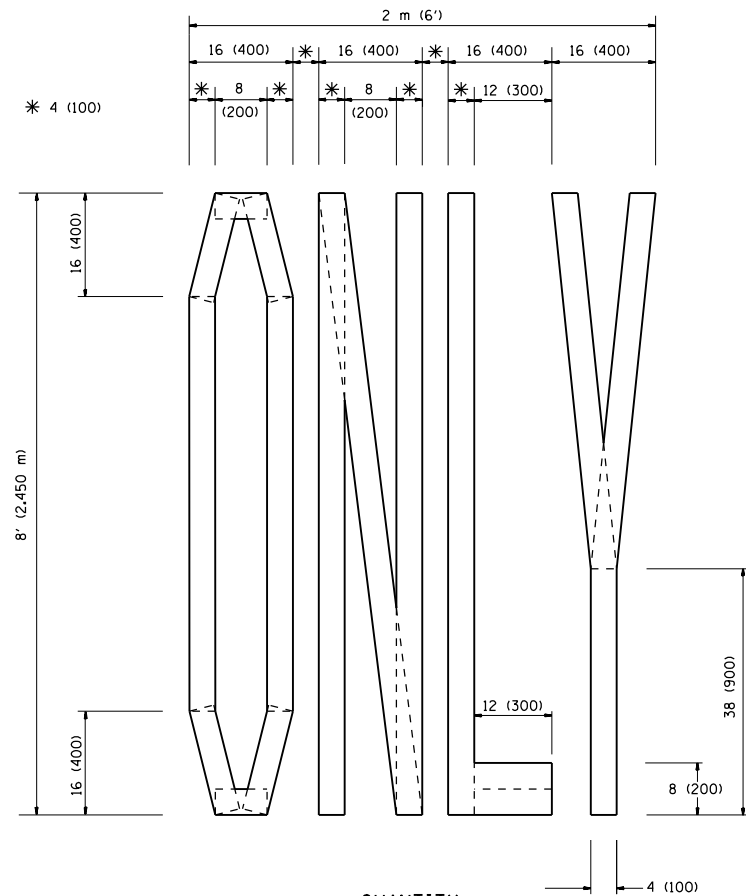

QUANTITY
 4 (100) LINE = 64.1 ft. (19.7 m)
 21.1 sq. ft. (1.97 sq. m)

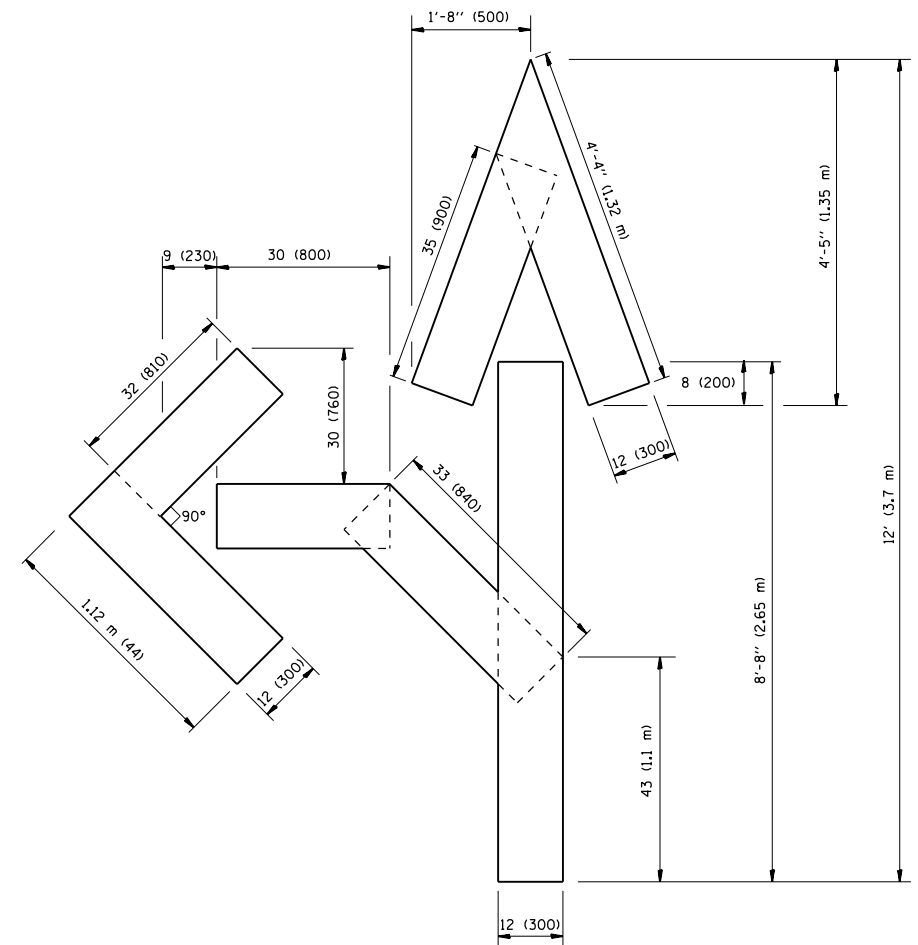

QUANTITY
 4 (100) LINE = 82.5 ft. (25.3 m)
 27.5 sq. ft. (2.53 sq. m)

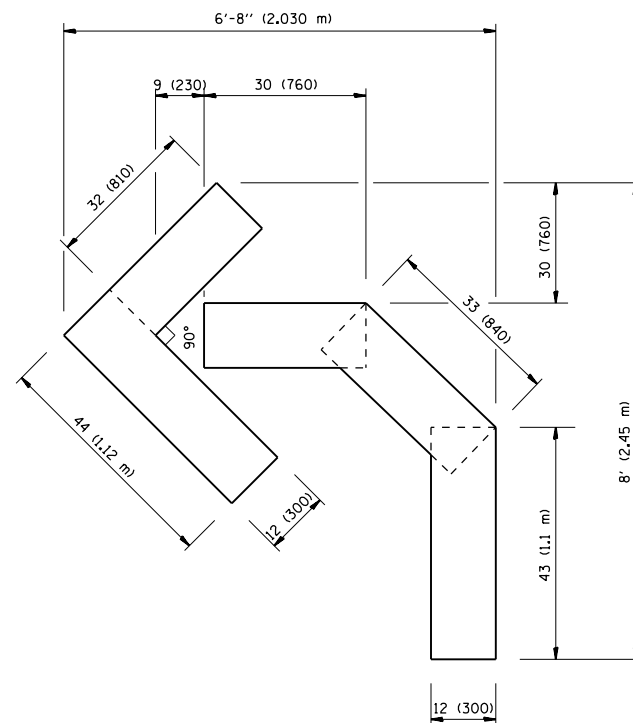

QUANTITY
 4 (100) LINE = 45.5 ft. (13.9 m)
 15.2 sq. ft. (1.39 sq. m)

All dimensions are in inches (millimeters) unless otherwise shown.

FILE NAME =	USER NAME = Aumm	DESIGNED -	REVISED -T. RAMMACHER 06-05-96
et:\pw\work\p\dot\Aumm\d0382486\60Y13-D	stStd.dgn	DRAWN -	REVISED -T. RAMMACHER 11-04-97
	PLOT SCALE = 100.0000' / in.	CHECKED -	REVISED -T. RAMMACHER 03-02-98
	PLOT DATE = 4/4/2014	DATE - 09-18-94	REVISED -E. GOMEZ 08-28-00

STATE OF ILLINOIS
 DEPARTMENT OF TRANSPORTATION

PAVEMENT MARKING LETTERS AND SYMBOLS
 FOR TRAFFIC STAGING

SCALE: NONE SHEET NO. 1 OF 1 SHEETS STA. TO STA.

F.A. RTE.	SECTION	COUNTY	TOTAL SHEETS	SHEET NO.
VAR.	2014-027RS	MCHENRY	33	30
TC-16		CONTRACT NO. 60Y13		
FED. ROAD DIST. NO. 1 ILLINOIS FED. AID PROJECT				

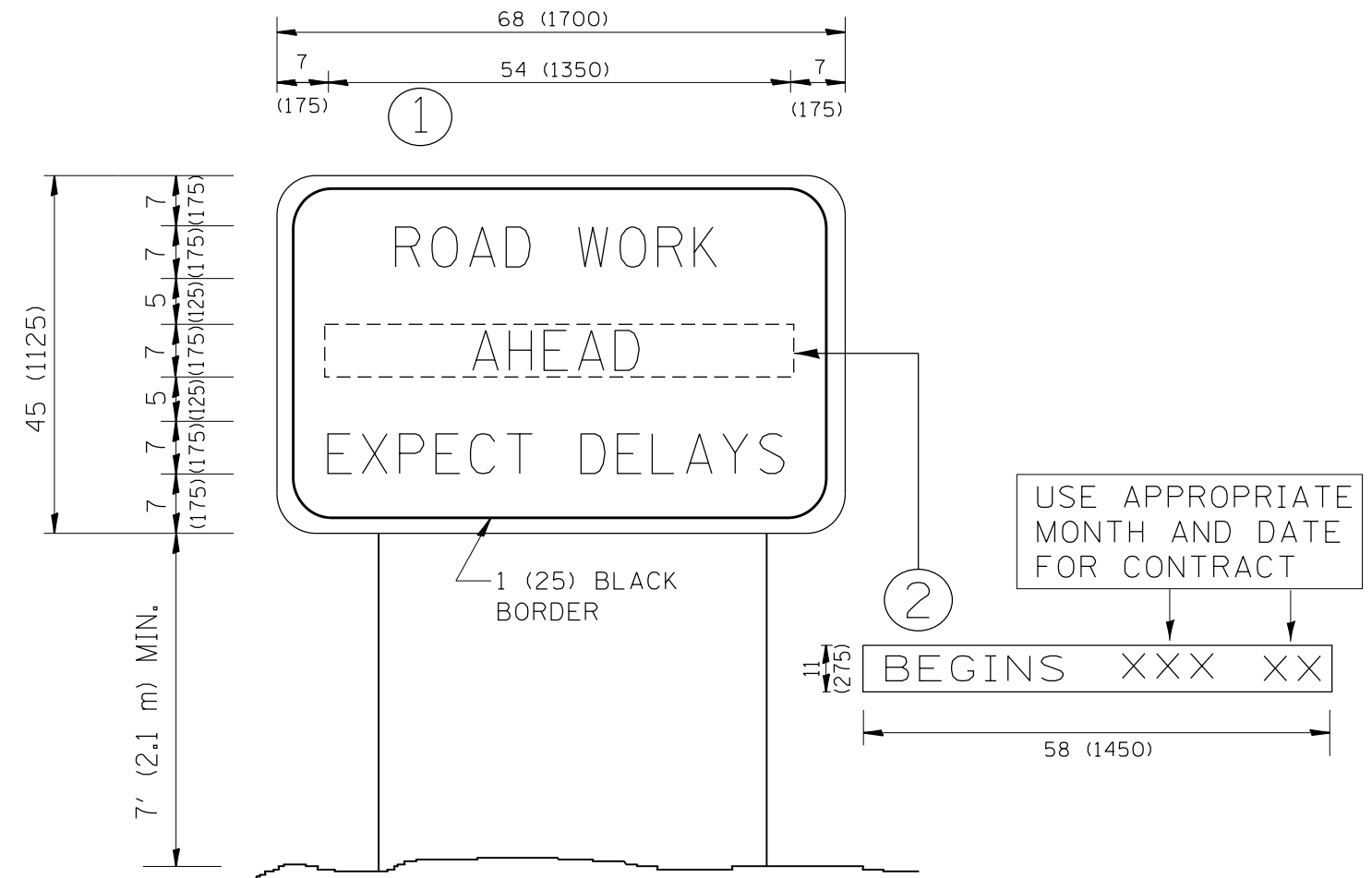

NOTES:

1. USE BLACK LETTERING ON ORANGE BACKGROUND.
2. ERECT SIGNS IN ADVANCE OF THE LOCATION FOR THE "ROAD CONSTRUCTION AHEAD" SIGN AT LOCATIONS AS DIRECTED BY THE ENGINEER.
3. ERECT SIGN ① WITH INSTALLED PANEL ② ONE WEEK PRIOR TO THE START OF CONSTRUCTION.
4. REMOVE PANEL ② SOON AFTER THE START OF CONSTRUCTION.
5. SEE SPECIAL PROVISION FOR "TEMPORARY INFORMATION SIGNING" FOR ADDITIONAL INFORMATION.
6. ONE SIGN ASSEMBLY EQUALS 25.70 SQ. FT. (2.3 SQ. M.)
7. SHALL BE PAID FOR AS TEMPORARY INFORMATION SIGNING.

ALL DIMENSIONS ARE IN INCHES (MILLIMETERS) UNLESS OTHERWISE SHOWN.

FILE NAME =	USER NAME = Aumm	DESIGNED -	REVISED - R. MIRS 09-15-97
et:\pw\work\p1dot\aumm\d0382486\60Y13-D	stStd.dgn	DRAWN -	REVISED - R. MIRS 12-11-97
	PLOT SCALE = 100.0000' / 1in.	CHECKED -	REVISED - T. RAMMACHER 02-02-99
	PLOT DATE = 4/4/2014	DATE -	REVISED - C. JUCIUS 01-31-07

**STATE OF ILLINOIS
DEPARTMENT OF TRANSPORTATION**

ARTERIAL ROAD INFORMATION SIGN	
SCALE: NONE	SHEET NO. 1 OF 1 SHEETS
STA.	TO STA.

F.A. RTE.	SECTION	COUNTY	TOTAL SHEETS	SHEET NO.
VAR.	2014-027RS	MCHENRY	33	31
TC-22		CONTRACT NO. 60Y13		
<small>FED. ROAD DIST. NO. 1 ILLINOIS FED. AID PROJECT</small>				

LOOP DETECTOR NOTES

1. EACH PAIR OF LOOP WIRES SHALL BE PLACED IN A SEPARATE EMPTY COILABLE NONMETALLIC CONDUIT FROM THE EDGE OF PAVEMENT TO THE HANDHOLE. SPACING BETWEEN THE HOLES DRILLED IN THE PAVEMENT SHALL NOT BE LESS THAN 6" (150 mm). EMPTY COILABLE NONMETALLIC CONDUIT SHALL BE INCLUDED IN THE COST OF THE LOOP WIRE.
2. THE NUMBER OF LOOP TURNS SHALL BE AS RECOMMENDED BY THE AMPLIFIER MANUFACTURER. ALL ADJACENT SIDES OF THE LOOPS SHALL BE INSTALLED IN SUCH A WAY THAT THE CURRENT FLOW IS IN THE SAME DIRECTION TO REINFORCE ITS MAGNETIC FIELDS FOR SMALL VEHICLE DETECTION.
3. EACH LOOP LEAD-IN SHALL BE IDENTIFIED AND PERMANENTLY TAGGED IN THE HANDHOLE. EACH LEAD-IN CABLE TAG SHALL INDICATE THE LOCATION OF THE LOOP, LOOP ROTATION (CLOCKWISE/COUNTERCLOCKWISE), LOOP LEAD-IN DIRECTION (IN OR OUT), LOOP CABLE NUMBER AND LOCATION IN CABINET, AND NUMBER OF TURNS IN THE DETECTOR LOOPS IN WATER PROOF INK AS INDICATED ON THE DISTRICT 1 STANDARD TRAFFIC SIGNAL DESIGN DETAIL. THE CONTRACTOR SHALL MARK LOOP LOCATIONS ON RECORD DRAWINGS AND PRESENT TO THE ENGINEER AFTER FINAL INSPECTION. LOOPS SHALL BE MARKED BY LANE AND LOOP NUMBER. SEE DETAIL BELOW.
4. ALL LOOP CABLE SHALL BE FASTENED WITH PLASTIC TIE WRAP TO THE HANDHOLE HOOKS.
5. IN ASPHALT PAVEMENT, LOOPS SHOULD BE PLACED IN THE BINDER AND DIVEHOLES MARKED AT THE CURB WITH A SAW-CUT. THE SAW-CUT SHALL BE CUT IN ACCORDANCE WITH LOCAL AND E.P.A. DUST CONTROL REQUIREMENTS. DETECTOR LOOP(S) SHALL NOT BE INSTALLED IN WET CONDITIONS AND THE SAW-CUTS MUST BE FREE OF DEBRIS AND RESIDUE SUCH AS DUST AND WATER WHICH IS TO BE ACHIEVED BY THE USE OF COMPRESSED AIR, WIRE BRUSHING AND HEAT DRYING ACCORDING TO SEALANT MANUFACTURER REQUIREMENTS. THE DETECTOR WIRE SHALL BE HELD IN PLACE BY THE USE OF FORM WEDGES. WEDGES SHALL BE SPACED NO MORE THAN 18" (450 mm) APART.
6. LOOP SPLICES SHALL BE SOLDERED USING A SOLDERING IRON. BLOW TORCHES OR OTHER DEVICES WHICH OXIDIZE COPPER CABLE SHALL NOT BE ALLOWED FOR SOLDERING OPERATIONS. SEE DETAIL BELOW RIGHT.
7. PREFORMED DETECTOR LOOPS SHALL BE USED, AS SHOWN ON THE PLANS, WHERE NEW CONCRETE PAVEMENT IS PROPOSED. THE INSTALLATION OF PREFORMED LOOPS SHALL BE IN ACCORDANCE WITH THE DISTRICT 1 SPECIFICATIONS OR AS DIRECTED BY THE ENGINEER.

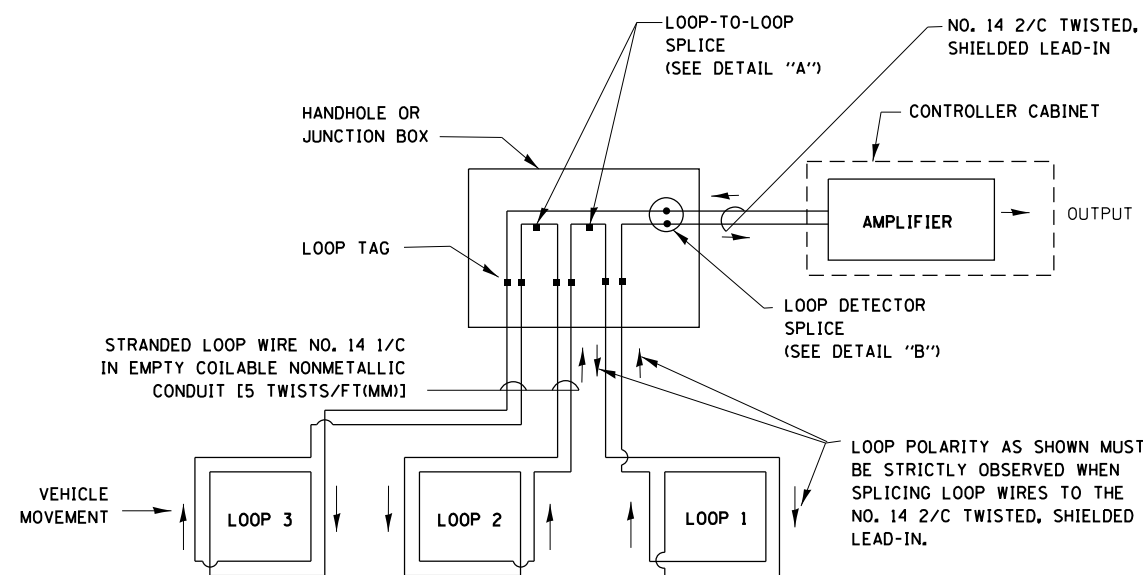

DETECTOR LOOP WIRING SCHEMATIC

- LOOPS SHALL BE SPLICED IN SERIES.
- SAW-CUTS SHALL BE A MINIMUM WIDTH OF 5/16" (8 mm).
- SAW-CUT DEPTHS SHALL BE 3" (75 mm). IF IN CONCRETE, THE SAW-CUT DEPTH SHALL BE TO THE TOP OF THE REINFORCEMENT.
- LOOP CORNERS SHALL BE DRILLED WITH A 2" (50 mm) DIAMETER CORE.

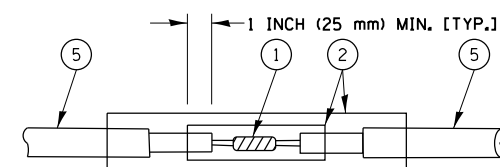

**DETAIL "A"
LOOP-TO-LOOP SPLICE**

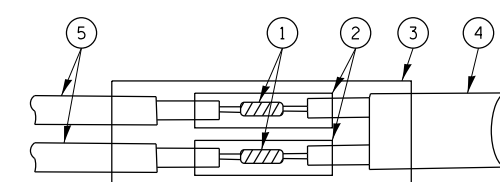

**DETAIL "B"
LOOP-TO-CONTROLLER SPLICE**

TYPE I LOOP

LOOP LEAD-IN CABLE TAG

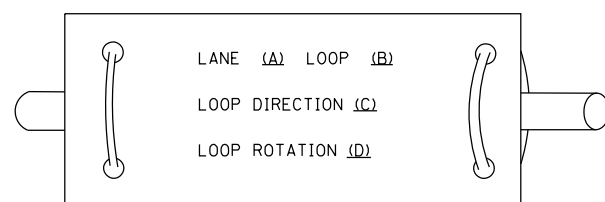

- A. LANE 1 IS THE LANE CLOSEST TO THE CENTERLINE OF THE ROADWAY
- B. LOOP #1 IS THE LOOP IN THE LANE CLOSEST TO THE INTERSECTION.
- C. LABEL LOOP CABLE "IN" OR LOOP CABLE "OUT".
- D. LABEL LOOP CABLE CLOCKWISE OR LOOP CABLE COUNTERCLOCKWISE.

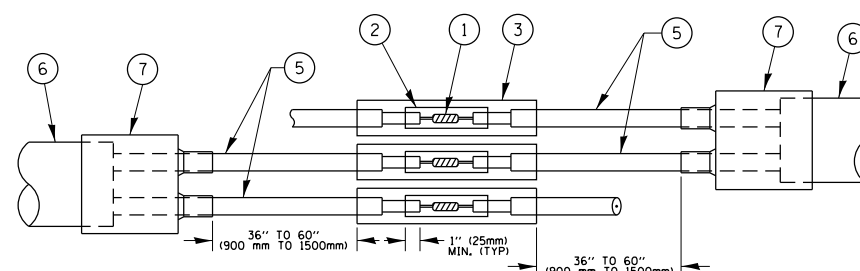

**DETAIL "A"
LOOP-TO-LOOP SPLICE**

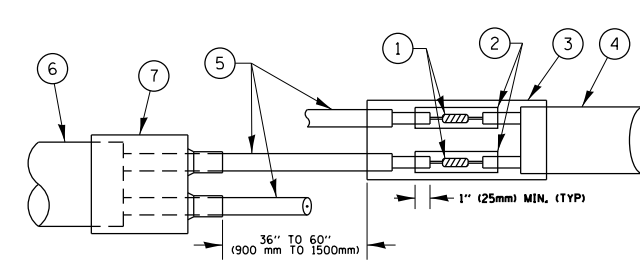

**DETAIL "B"
LOOP-TO-CONTROLLER SPLICE**

LOOP DETECTOR SPLICE

- ① WESTERN UNION SPLICE SOLDERED WITH ROSIN CORE FLUX. ALL EXPOSED SURFACES OF THE SOLDER SHALL BE SMOOTH, THE WESTERN UNION SPLICES SHALL BE STAGGERED.
- ② WCSMW 30/100 HEAT SHRINK TUBE, MINIMUM LENGTH 3" (75 mm), UNDERWATER GRADE.
- ③ WCS 200/750 HEAT SHRINK TUBE, MINIMUM LENGTH 6" (150 mm), UNDERWATER GRADE.
- ④ NO. 14 2/C TWISTED, SHIELDED CABLE.
- ⑤ LOOP CONDUCTOR WITH FLEXIBLE PLASTIC TUBE.
- ⑥ PRE-FORMED LOOP
- ⑦ XL POLYOLEFIN 2 CONDUCTOR BREAKOUT SEALS, TYCO CBR-2 OR APPROVED EQUAL

LOOPS NEXT TO SHOULDERS

PROVIDE A PAVEMENT REPLACEMENT NOTE WHICH SHOULD EQUAL 3' (900 mm) X WIDTH OF PAVED SHOULDER.

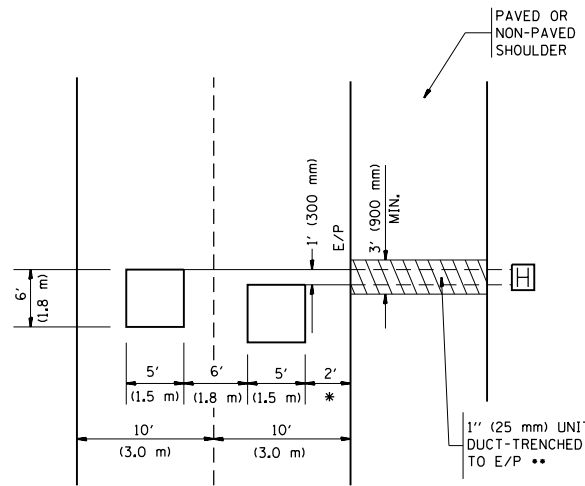

* = (600 mm)

** UNIT DUCT IS TO BE SHOWN ON PLAN SHEETS BUT SHALL NOT BE INCLUDED IN THE PAY ITEMS.

**LEFT TURN LANES WITH MEDIANS
VOLUME DENSITY ("FAR OUT" DETECTION)
ON SAME APPROACH**

(PROTECTED / PERMITTED LEFT TURN PHASING)

HANDHOLE LOCATION MAY VARY DEPENDING ON GEOMETRICS AND DESIGN OF TRAFFIC SIGNALS. HEAVY-DUTY HANDHOLES TO BE USED WHEN THE MEDIAN IS MOUNTABLE. REFER TO STANDARD 814001 TO ENSURE THAT HANDHOLE FITS IN MEDIAN.

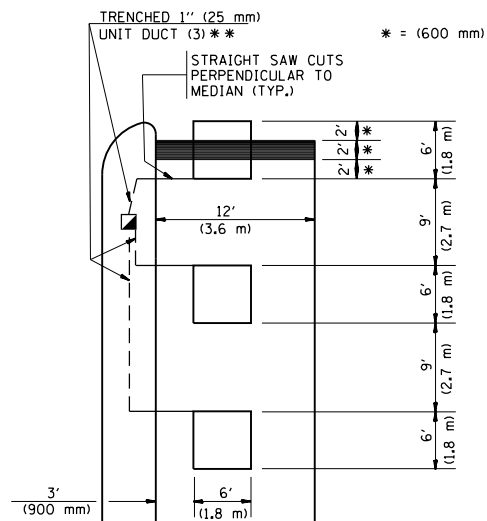

** UNIT DUCT IS TO BE SHOWN ON PLAN SHEETS BUT SHALL NOT BE INCLUDED IN THE PAY ITEMS.

NOTE: DUAL LEFT TURNS NOT SHOWN REFER TO PLAN SHEET FOR DETECTOR LOOP REPLACEMENT

**LEFT TURN LANES WITHOUT MEDIANS
VOLUME DENSITY ("FAR OUT" DETECTION)
ON SAME APPROACH**

(PROTECTED / PERMITTED LEFT TURN PHASING)

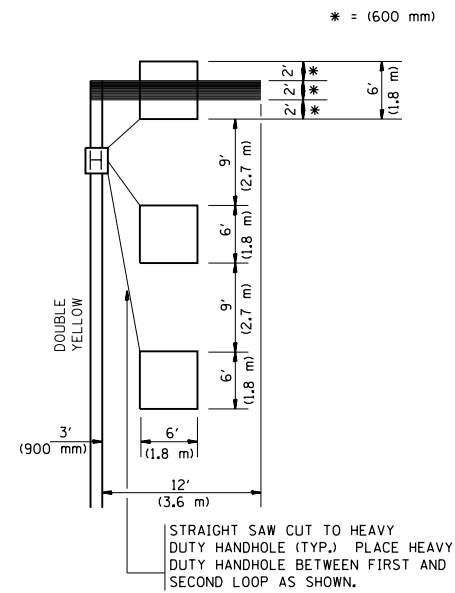

NOTE: DUAL LEFT TURNS NOT SHOWN REFER TO PLAN SHEET FOR DETECTOR LOOP REPLACEMENT

**ARTERIAL-VOLUME DENSITY ("FAR OUT" DETECTION)
CROSS STREET-VOLUME DENSITY ("FAR OUT" DETECTION)**

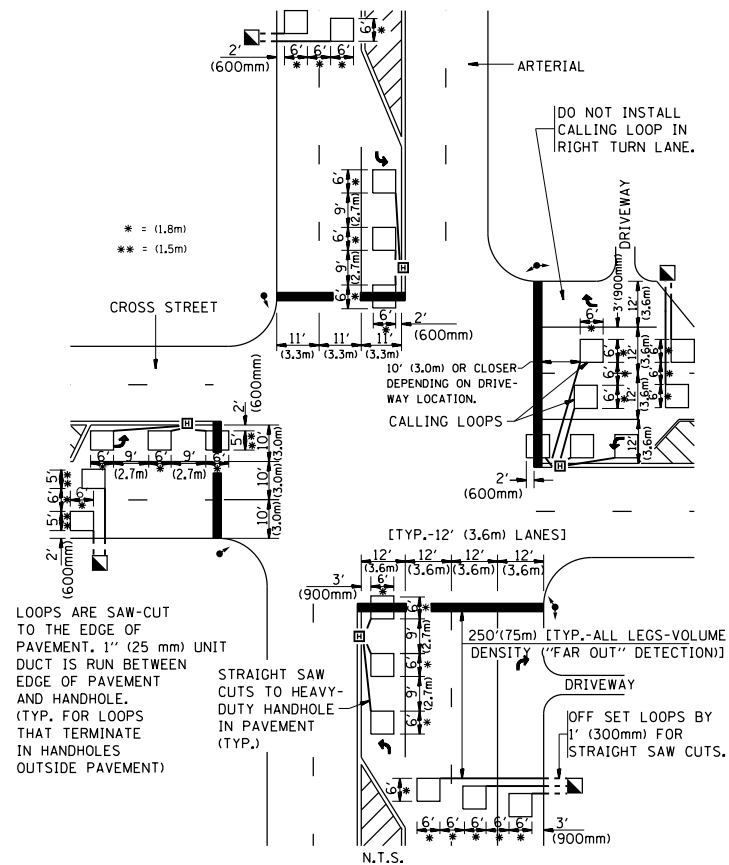

DETAIL 1
N.T.S.

**ARTERIAL-VOLUME DENSITY ("FAR OUT" DETECTION)
CROSS STREET-NON VOLUME DENSITY ("UPTIGHT" PRESENCE DETECTION)**

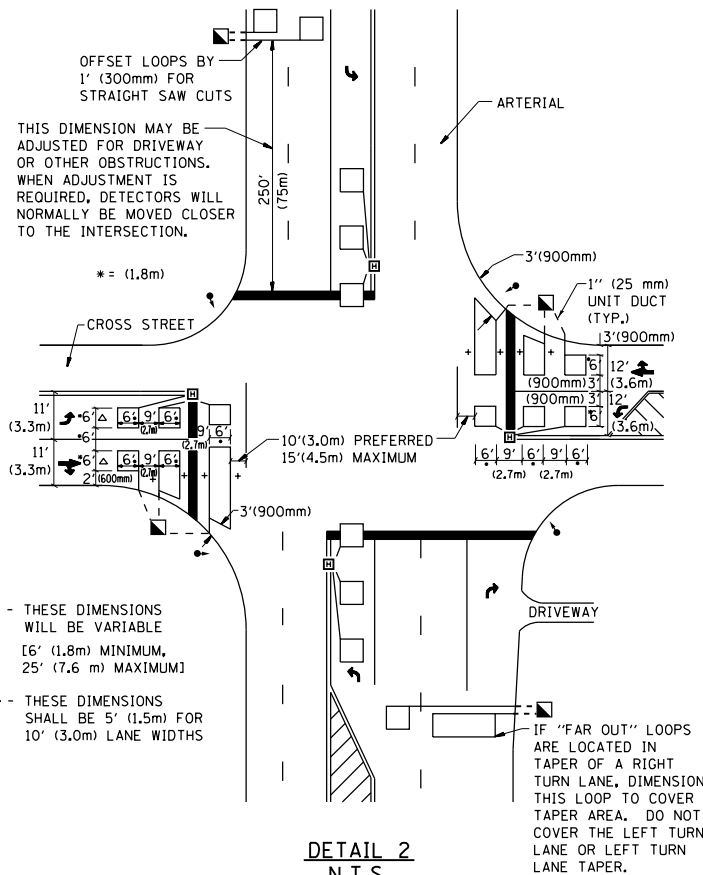

DETAIL 2
N.T.S.

NOTES:

VEHICLES LOOP DETECTORS

- * ALL LEAD IN CABLE SHALL BE TWO CONDUCTOR NO. 14 TWISTED, SHIELDED.
- * EACH DETECTOR LOOP SHALL HAVE ITS OWN SAW CUT FROM THE LOOP TO THE EDGE OF PAVEMENT OR TO A HANDHOLE IN THE PAVEMENT.
- * EACH DETECTOR LOOP SHALL HAVE ITS OWN ONE INCH (25 mm) UNIT DUCT BETWEEN THE EDGE OF PAVEMENT AND THE FIRST HANDHOLE OR JUNCTION BOX. EACH UNIT DUCT RUN SHALL BE SHOWN ON THE PLANS BY THE DESIGNER, BUT SHALL NOT BE PAID FOR SEPARATELY. THIS ITEM IS INCIDENTAL TO THE PAY ITEM FOR DETECTOR LOOPS.
- * ONE DIMENSION OF ALL DETECTOR LOOPS SHALL BE SIX FEET (1.8 m)
- * EACH LANE OF NON-LOCKING, PRESENCE DETECTION AND EACH LANE OF A DOUBLE LEFT TURN LANE REQUIRES A SEPARATE INDUCTIVE LOOP DETECTOR AND LEAD IN CABLE.
- * WHEN NON-LOCKING, PRESENCE DETECTION IS USED, MORE THAN ONE LOOP PER LANE IS REQUIRED BEHIND THE STOP BAR (i.e. 1-1/2, 1-3/4, 2).
- * WHEN SYSTEM LOOPS ARE REQUIRED ON AN APPROACH OF AN INTERSECTION, THE LOOPS USED FOR VOLUME DENSITY AND INTERSECTION TIMING SHALL ALSO BE USED AS SYSTEM DETECTORS. EACH ONE OF THESE TYPE OF LOOPS REQUIRES A SEPARATE TWO CONDUCTOR NO. 14 TWISTED SHIELDED CABLE AND A SEPARATE INDUCTIVE LOOP DETECTOR WHEN NEW CONTROLLERS ARE UTILIZED. THE DESIGNER SHALL LABEL THESE TYPES OF LOOPS AS "INTERSECTION AND SAMPLING (SYSTEM) DETECTORS" ON THE SIGNAL LAYOUT, THE INTERCONNECT PLAN AND THE SYSTEM CABLE PLAN. WHEN AN EXISTING CONTROLLER IS UTILIZED FOR THIS TYPE OF DETECTION, THE PAY ITEM "INDUCTIVE LOOP DETECTOR WITH SYSTEM OUTPUT" SHOULD BE USED.

PLACEMENT OF DETECTORS

THE FOLLOWING FIGURES REPRESENT THE MOST COMMON DETECTOR LOOP LOCATIONS AND SIZES. ADJUSTMENTS WILL BE NECESSARY FOR SPECIFIC GEOMETRIC CONSIDERATIONS.

LOCATIONS AND DEMENSIONS OF DETECTOR LOOPS ARE REQUIRED ON ALL SIGNAL LAYOUT PLAN SHEETS.

"FAR OUT" DETECTION REFERS TO LOCKING, PRESENCE TYPE DETECTION LOCATED IN THRU LANES, RIGHT TURN LANES, AND RIGHT TURN LANE TAPER AREAS (IF APPLICABLE), USUALLY 250' (75 m) IN ADVANCE OF STOP BARS. "UPTIGHT" DETECTION REFERS TO NON-LOCKING PRESENCE TYPE DETECTION LOCATED IN ALL LANES AND 10'-15' (3.0 m-4.5 m) BEHIND THE CROSSING STREET'S EDGE OF PAVEMENT EXTENDED.

NOTE:

ALL DETAILS AND NOTES SHOWN ARE FROM THE I.D.O.T. DISTRICT 1 TRAFFIC SIGNAL DESIGN GUIDELINES DATED JANUARY 1995

THIS DRAWING HAS BEEN PREPARED TO ASSIST THE RESIDENT ENGINEER FOR ALL ROADWAY RESURFACING OR S.M.A.R.T. PROJECTS WHERE THE DIMENSIONS ARE NOT SHOWN ON THE PLANS AND THE FINAL LOCATIONS FOR CROSSWALKS OR STOP BARS ARE NOT DETERMINED.

FILE NAME =	USER NAME = Aumm	DESIGNED -	REVISED -	STATE OF ILLINOIS DEPARTMENT OF TRANSPORTATION	DISTRICT 1 - DETECTOR LOOP INSTALLATION DETAILS FOR ROADWAY RESURFACING	F.A. RTE.	SECTION	COUNTY	TOTAL SHEETS	SHEET NO.
et:\pw\work\p\dot\au\m\d0382486\60Y13-D	stStd.dgn	DRAWN -	REVISED -			VAR.	2014-027R5	MCHENRY	33	33
PLOT SCALE = 100.0000' / 1"	CHECKED - R.K.F.	REVISED -	REVISED -			TS-07		CONTRACT NO. 60Y13		
PLOT DATE = 4/4/2014	DATE -	REVISED -	REVISED -			SCALE: NONE	SHEET NO. 1 OF 1 SHEETS	STA.	TO STA.	FED. ROAD DIST. NO. 1 ILLINOIS FED. AID PROJECT