

PANEL SIGN DESIGN TYPE 1

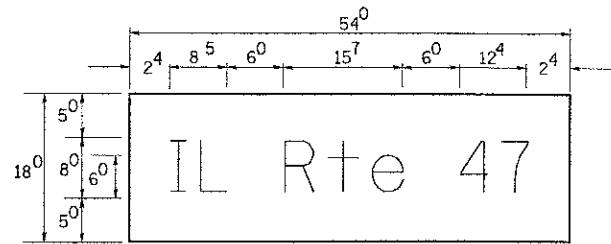

___ Sq. M. each
6.75 Sq. Ft. each
1 Required
Design Series D

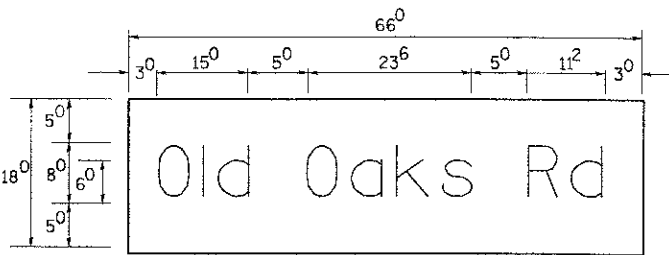

___ Sq. M. each
8.25 Sq. Ft. each
1 Required
Design Series D

NOTE: SIGN DIMENSIONS ARE IN ENGLISH UNITS

PANEL SIGN DESIGN TYPE 2

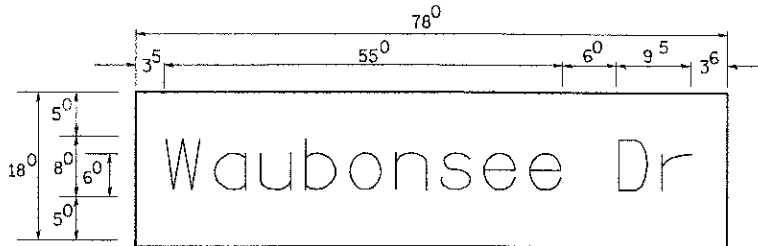

___ Sq. M. each
9.75 Sq. Ft. each
2 Required
Design Series D

GENERAL NOTES

- WHERE MAST ARM MOUNTED STREET NAME SIGNS ARE SPECIFIED, THE MAST ARM ASSEMBLY AND POLES SHALL BE DESIGNED TO SUPPORT THE LOADINGS CALLED FOR ON STANDARDS 877001, 877002, 877006, 877011 AND 877012, AS APPLICABLE, PLUS TWO (2) SIGN PANELS 2'-6" x 8'-0" MOUNTED AS SHOWN. THE DESIGN SHALL BE IN ACCORDANCE WITH THE REQUIREMENTS OF THE CURRENT "STANDARD SPECIFICATIONS FOR STRUCTURAL SUPPORTS FOR HIGHWAY SIGNS, LUMINAIRES, AND TRAFFIC SIGNALS" AS PUBLISHED BY THE AMERICAN ASSOCIATION OF STATE HIGHWAY AND TRANSPORTATION OFFICIALS FOR 80 M.P.H. WIND VELOCITY.
- ALL SIGNS SHALL HAVE A WHITE REFLECTORIZED LEGEND AND BORDER ON A GREEN REFLECTORIZED BACKGROUND, TYPE A SHEETING.
- THE SIGN LENGTH SHOULD BE INCREASED IN 6-INCH INCREMENTS, BUT THE OVERALL LENGTH SHOULD NOT EXCEED 8'-0".
- ALL BORDERS SHALL BE 3/4" WIDE AND CORNER RADIUS SHALL BE 2-1/4".
- SIGNFIX ALUMINUM CHANNEL FRAMING SYSTEM SHALL BE USED FOR ALL SIGNS ATTACHED TO SIGNAL POLES AND POSTS. LOCAL SUPPLIERS OF THE SIGNFIX ALUMINUM CHANNEL FRAMING SYSTEM ARE:

* J.O. HERBERT CO.
MIDLOTHIAN, VA.

* WESTERN REMAC INC.
WOODRIDGE, IL.

PARTS LISTING:
SIGN CHANNEL
SIGN SCREWS

PART #HPN053 (MED. CHANNEL)
1/4" x 14 x 1" H.W.H. #3
SELF TAPPING WITH NEOPRENE WASHER
PART #HPN034 (UNIVERSAL)
CHANNEL CLAMPS WITH STAINLESS STEEL STRAPPING

OTHER BRANDS OF MOUNTING HARDWARE ARE ACCEPTABLE, BASED UPON THE DEPARTMENT'S APPROVAL AND COMPATIBILITY WITH THE CHANNEL/BACKET OF THE ABOVE PRODUCT.

SUPPORTING CHANNELS

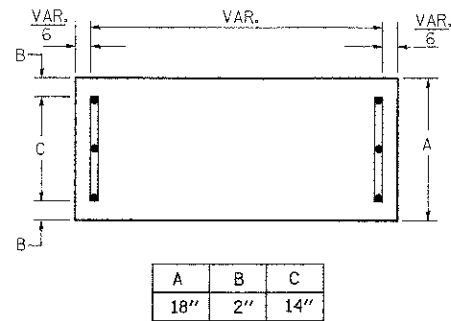

A	B	C
18"	2"	14"

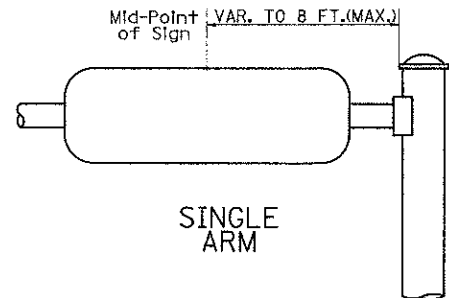

SUPPORTING CHANNELS

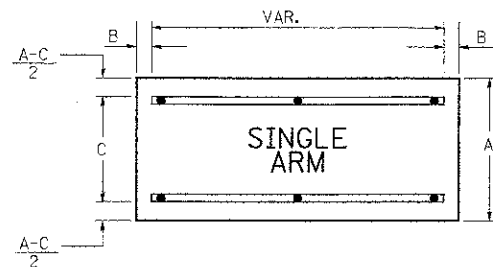

A	B	C
18"	2"	12"
30"	2"	22"

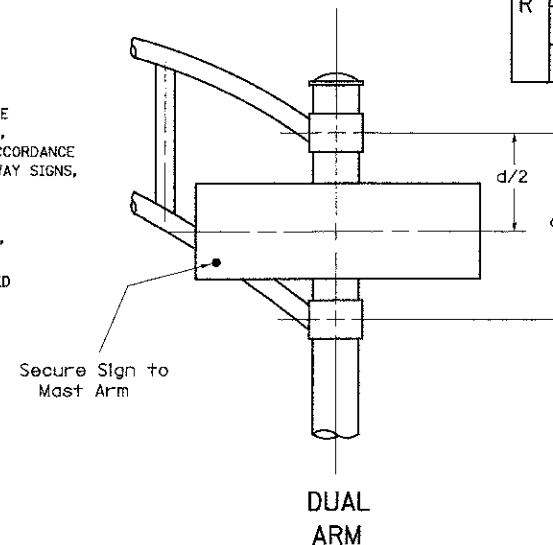

SIGNFIX ALUMINUM CHANNEL FRAMING SYSTEM shall be used. See Note #5.

Upper Case To Lower Case
Spacing Chart 8-6 Inch Series "C & D"

SERIES	SECOND LETTER															
	acde		bhkl		fw		J		st		vy		x		z	
	C	D	C	D	C	D	C	D	C	D	C	D	C	D	C	D
A W X	12	14	14	15	12	14	06	10	11	14	06	10	11	12	12	14
B	14	15	20	21	14	15	11	12	14	15	12	14	12	14	16	17
C E G	14	15	20	21	12	14	06	10	12	14	12	14	14	15	14	15
D O Q R	14	15	20	21	14	15	06	10	12	14	12	14	14	15	14	15
F	05	06	14	15	06	10	05	06	06	10	06	10	06	10	11	12
H I M N	20	21	22	24	20	21	14	15	16	17	16	17	20	21	20	21
J U	20	21	20	21	16	17	14	15	16	17	16	17	16	17	20	21
K L	11	12	16	17	11	12	05	06	11	12	11	12	11	12	12	14
P	12	14	14	15	12	14	05	06	11	12	11	12	12	14	12	14
S	12	14	16	17	12	14	06	10	12	14	12	14	12	14	12	14
T	11	12	16	17	06	10	06	10	11	12	11	12	11	12	12	14
V	06	10	14	15	11	12	06	10	12	14	12	14	12	14	12	14
Y	05	06	14	15	06	10	05	06	05	07	05	06	06	10	11	12
Z	16	17	22	24	16	17	12	14	16	17	16	17	16	17	20	21

Lower Case To Lower Case
Spacing Chart 6 Inch Series "C & D"

SERIES	SECOND LETTER															
	acde		bhkl		fw		J		st		vy		x		z	
	C	D	C	D	C	D	C	D	C	D	C	D	C	D	C	D
adhglj	16	17	22	24	16	17	12	14	14	15	14	15	16	17	16	17
lmnqu	16	17	22	24	16	17	12	14	14	15	14	15	16	17	16	17
bfkops	12	14	16	17	11	12	05	06	11	12	11	12	12	14	12	14
ce	12	14	16	17	12	14	06	10	12	14	12	14	12	14	12	14
r	06	10	12	14	06	10	03	03	05	06	05	06	06	10	06	10
tz	12	14	16	17	12	14	06	10	11	12	11	12	12	14	12	14
vy	11	12	14	15	11	12	05	06	06	10	06	10	11	12	11	12
w	11	12	14	15	11	12	05	06	11	12	11	12	11	12	12	14
x	12	14	16	17	11	12	05	06	11	12	11	12	11	12	12	14

Number To Number
Spacing Chart 8 Inch Series "C & D"

SERIES	SECOND NUMBER																			
	0		1		2		3		4		5		6		7		8		9	
	C	D	C	D	C	D	C	D	C	D	C	D	C	D	C	D	C	D	C	D
0 9	16	17	16	17	14	15	12	14	14	15	14	15	16	17	12	14	16	17	16	17
1	20	21	20	21	20	21	16	17	14	15	20	21	20	21	14	15	20	21	20	21
2 3 4	14	15	14	15	14	15	12	14	12	14	14	15	14	15	11	12	16	17	14	15
5	14	15	14	15	14	15	11	12	11	12	14	15	14	15	11	12	14	15	14	15
6	16	17	14	15	14	15	12	14	14	15	14	15	11	12	14	15	14	15	14	15
7	12	14	12	14	14	15	12	15	05	06	12	14	14	15	11	12	14	15	12	14
8	16	17	16	17	14	15	12	15	12	14	14	15	16	17	12	14	16	17	14	15

EXAMPLE, 2⁽³⁾ DENOTES 3/8

UPPER AND LOWER CASE
LETTER WIDTHS

LETTERS	6 INCH UPPER CASE LETTERS				8 INCH UPPER CASE LETTERS				LETTERS	6 INCH LOWER CASE LETTERS	
	SERIES		SERIES		SERIES		SERIES			C	D
	C	D	C	D	C	D	C	D			
A	3 ⁶	5 ⁰	5 ⁰	6 ⁵	a	3 ⁵	4 ²				
B	3 ²	4 ⁰	4 ³	5 ³	b	3 ⁵	4 ²				
C	3 ²	4 ⁰	4 ³	5 ³	c	3 ⁵	4 ¹				
D	3 ²	4 ⁰	4 ³	5 ³	d	3 ⁵	4 ²				
E	3 ⁰	3 ⁵	4 ⁰	4 ⁷	e	3 ⁵	4 ²				
F	3 ⁰	3 ⁵	4 ⁰	4 ⁷	f	2 ³	2 ⁶				
G	3 ²	4 ⁰	4 ³	5 ³	g	3 ⁵	4 ²				
H	3 ²	4 ⁰	4 ³	5 ³	h	3 ⁵	4 ²				
I	0 ⁷	0 ⁷	1 ¹	1 ²	i	1 ¹	1 ¹				
J	3 ⁰	3 ⁶	4 ⁰	5 ⁰	j	2 ⁰	2 ²				
K	3 ²	4 ¹	4 ³	5 ⁴	k	3 ⁵	4 ²				
L	3 ⁰	3 ⁵	4 ⁰	4 ⁷	l	1 ¹	1 ¹				
M	3 ⁷	4 ⁵	5 ¹	6 ¹	m	6 ⁰	7 ⁰				
N	3 ²	4 ⁰	4 ³	5 ³	n	3 ⁵	4 ²				
O	3 ⁴	4 ²	4 ⁵	5 ⁵	o	3 ⁶	4 ³				
P	3 ²	4 ⁰	4 ³	5 ³	p	3 ⁵	4 ²				
Q	3 ⁴	4 ²	4 ⁵	5 ⁵	q	3 ⁵	4 ²				
R	3 ²	4 ⁰	4 ³	5 ³	r	2 ⁶	3 ²				
S	3 ²	4 ⁰	4 ³	5 ³	s	3 ⁶	4 ²				
T	3 ⁰	3 ⁵	4 ⁰	4 ⁷	t	2 ⁷	3 ²				
U	3 ²	4 ⁰	4 ³	5 ³	u	3 ⁵	4 ²				
V	3 ⁵	4 ⁴	4 ⁷	6 ⁰	v	4 ²	4 ⁷				
W	4 ⁴	5 ²	6 ⁰	7 ⁰	w	5 ⁵	6 ⁴				
X	3 ⁴	4 ⁰	4 ⁵	5 ³	x	4 ⁴	5 ¹				
Y	3 ⁶	5 ⁰	5 ⁰	6 ⁶	y	4 ⁶	5 ³				
Z	3 ²	4 ⁰	4 ³	5 ³	z	3 ⁶	4 ³				

NUMBER	6 INCH SERIES		8 INCH SERIES	
	C	D	C	D
1	1 ²	1 ⁴	1 ⁵	2 ⁰
2	3 ²	4 ⁰	4 ³	5 ³
3	3 ²	4 ⁰	4 ³	5 ³
4	3 ⁵	4 ³	4 ⁷	5 ⁷
5	3 ²	4 ⁰	4 ³	5 ³
6	3 ²	4 ⁰	4 ³	5 ³
7	3 ²	4 ⁰	4 ³	5 ³
8	3 ²	4 ⁰	4 ³	5 ³
9	3 ²	4 ⁰	4 ³	5 ³
0	3 ⁴	4 ²	4 ⁵	5 ⁵